

Antenna Specification

1. Antenna Describe

Antenna Manufacturer	SHUN DA CHENG TECHNOLOGY CO., LTD
Address	4 / F, Building B5, Xinfu Industrial Park, Zhongqing Road, Heping Community, Fuhai Street, Baoan District, Shenzhen China
Antenna Model	GBX105B
Antenna Type	FPC Antenna
Antenna Gain	1.4dBi Max
Frequency Rang	2400-2500MHz
VSWR	≤ 2
Input Impedance	50Ω

2. External View Drawing

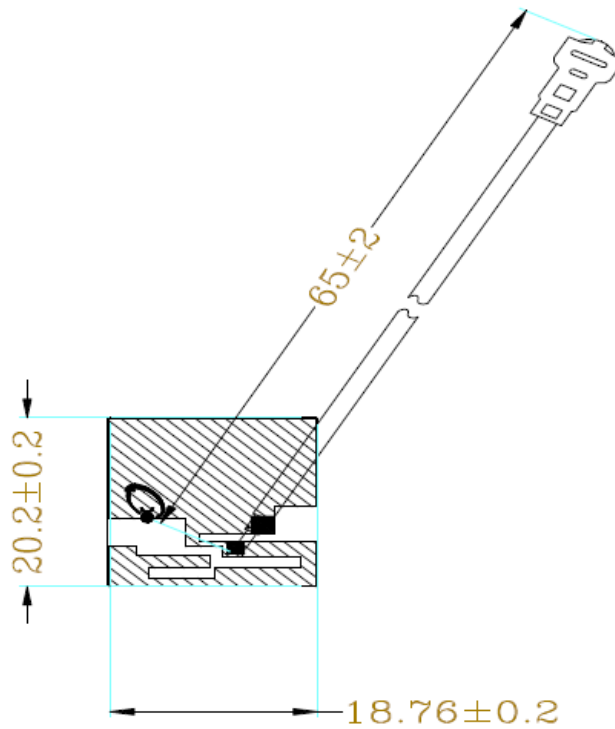

Unit: mm

3. Measurement Result

3.1 Test Setup

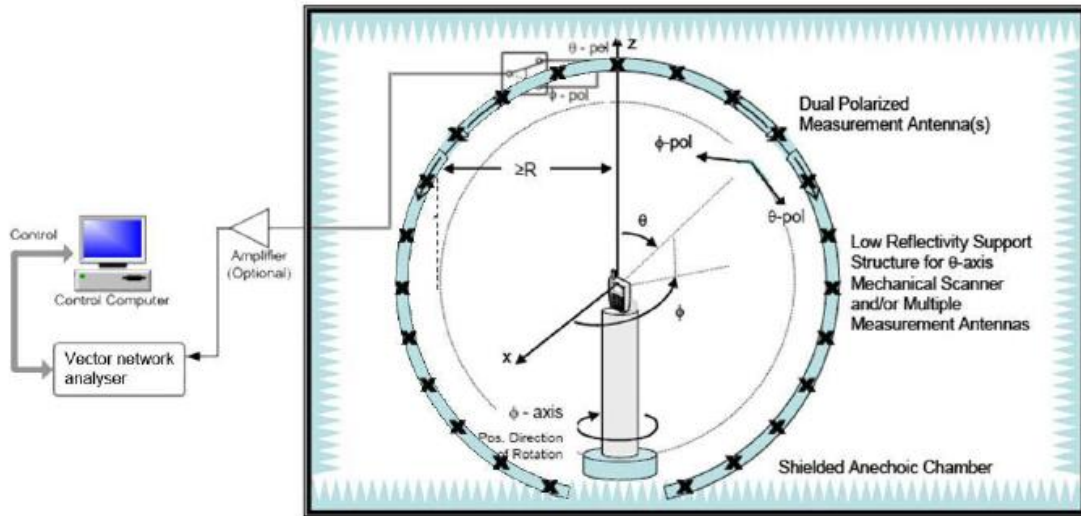

3.2 S11 Parameter

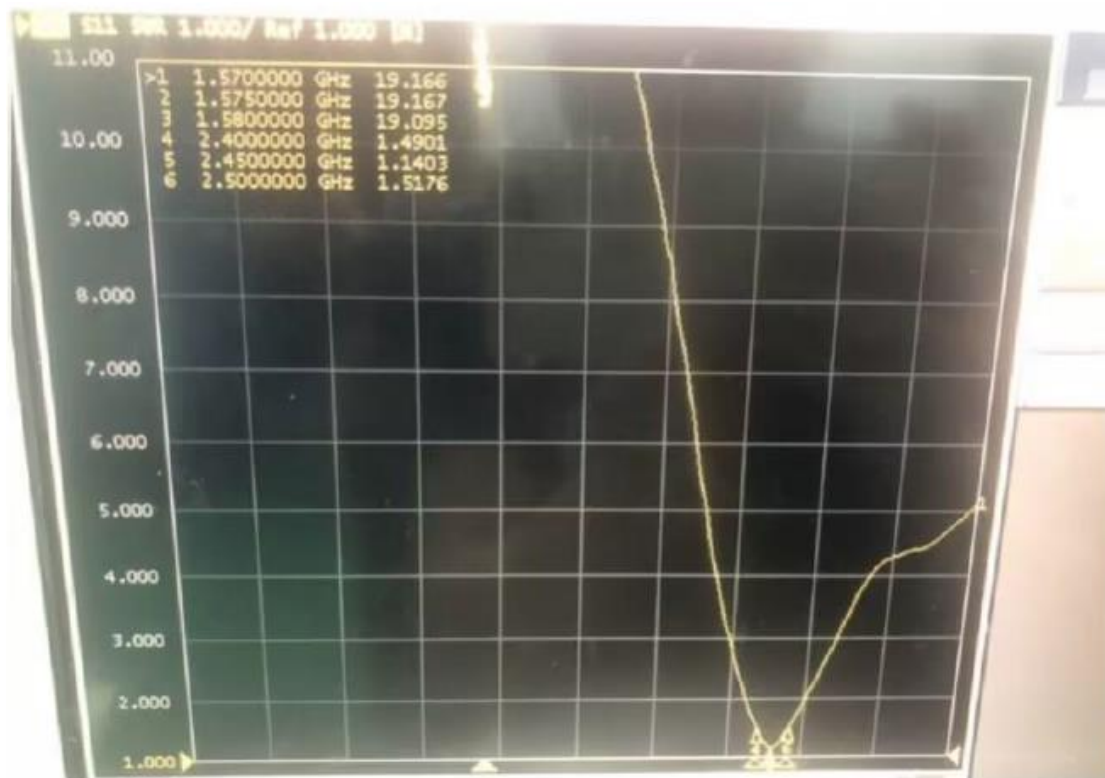

3.3 Antenna test data

Frequency (MHz)	Efficiency (%)	Gain (dBi)
2400	40.63	1.37
2450	41.71	1.40
2500	39.46	1.29

3.4 Antenna test diagram

2400.000MHz

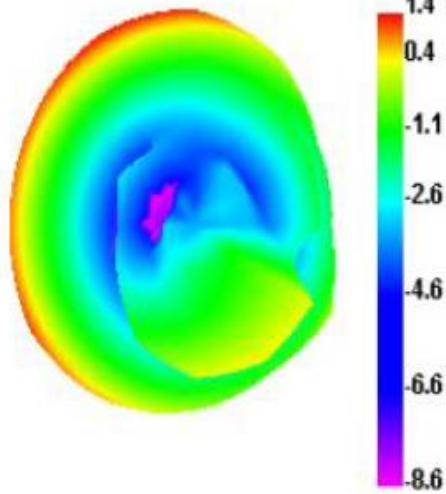

2400.000MHz H

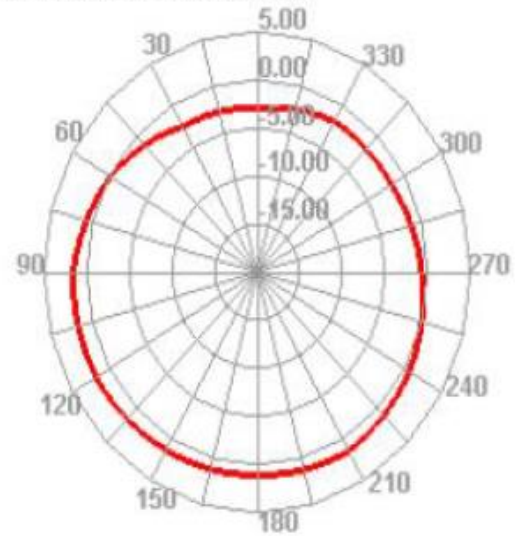

2400.000MHz E1

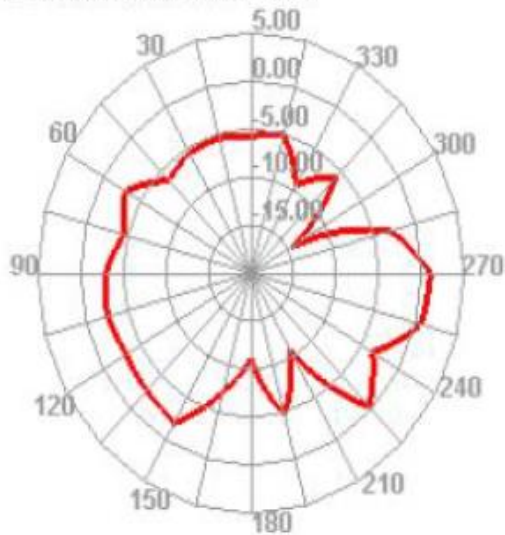

2400.000MHz E2

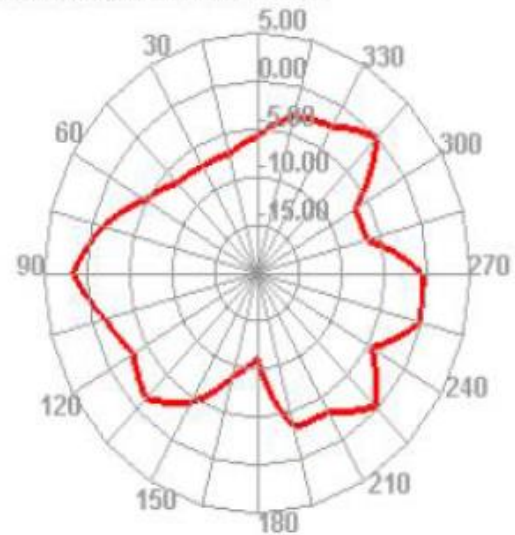

2450.000MHz

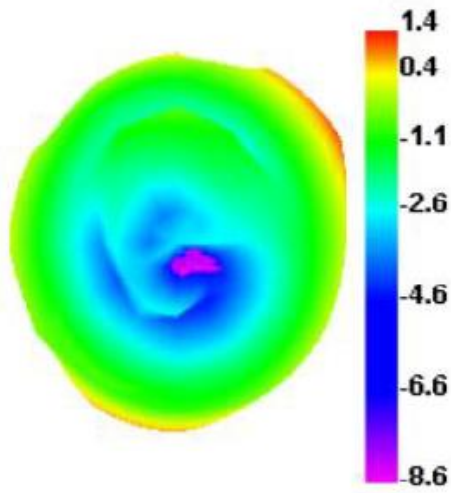

2450.000MHz H

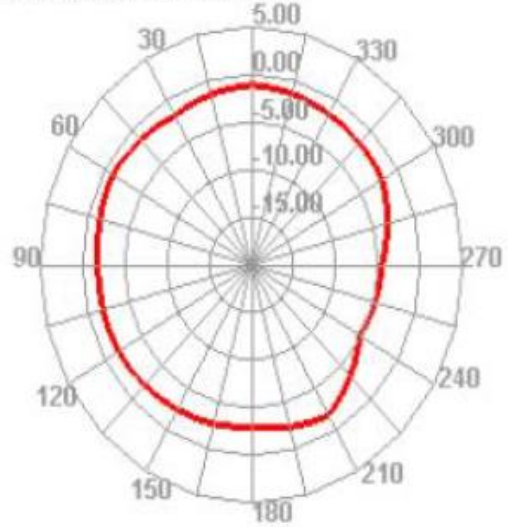

2450.000MHz E1

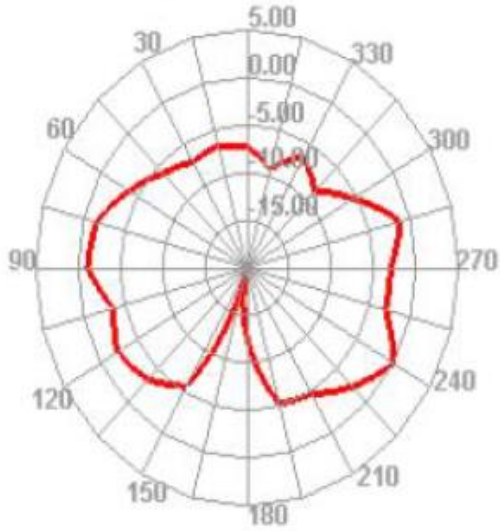

2450.000MHz E2

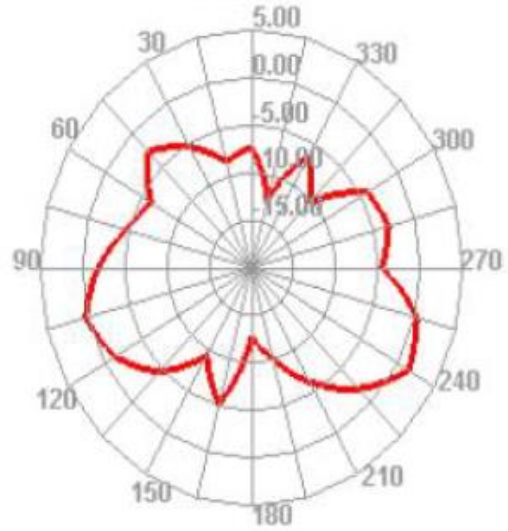

2500.000MHz

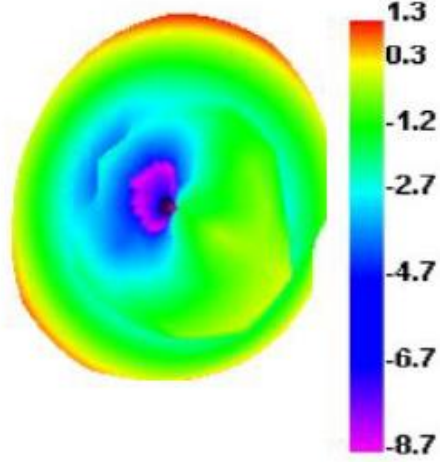

2500.000MHz H

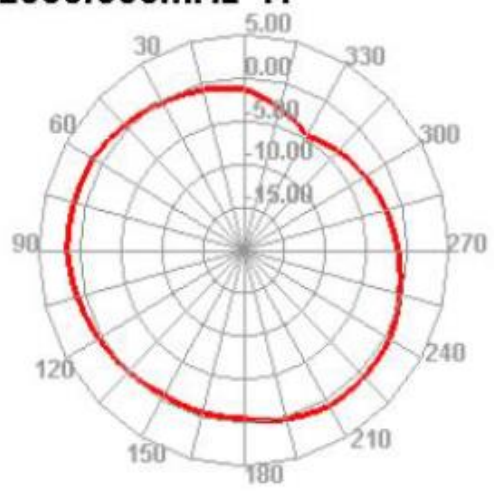

2500.000MHz E1

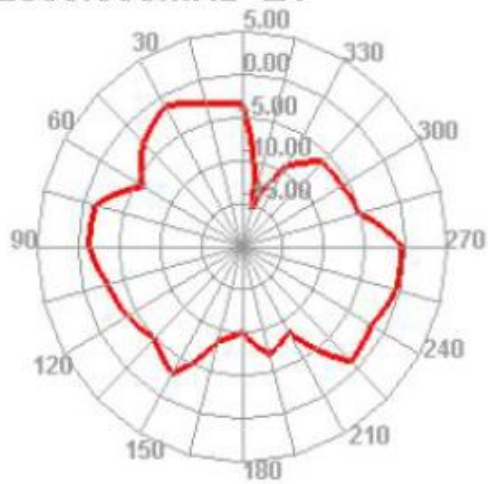

2500.000MHz E2

