

---

# FCC Test Report

---

Report No.: AGC00408221201FE06

**FCC ID** : 2A3DR-G2

**APPLICATION PURPOSE** : Original Equipment

**PRODUCT DESIGNATION** : 5G Smart phone

**BRAND NAME** : AGM

**MODEL NAME** : AGM G2, AGM G2 Pro, AGM G2 Guardian, AGM G2 1KM, Glory G2

**APPLICANT** : AGM MOBILE LIMITED

**DATE OF ISSUE** : Feb. 23, 2023

**STANDARD(S)** : FCC Part 15 Subpart E §15.407

**REPORT VERSION** : V1.0

Attestation of Global Compliance (Shenzhen) Co., Ltd



Any report having not been signed by authorized approver, or having been altered without authorization, or having not been stamped by the "Dedicated Testing/Inspection Stamp" is deemed to be invalid. Copying or excerpting portion of, or altering the content of the report is not permitted without the written authorization of AGC. The test results presented in the report apply only to the tested sample. Any objections to report issued by AGC should be submitted to AGC within 15days after the issuance of the test report. Further enquiry of validity or verification of the test report should be addressed to AGC by [agc01@agccert.com](mailto:agc01@agccert.com).

Attestation of Global Compliance(Shenzhen)Co., Ltd  
Attestation of Global Compliance(Shenzhen)Std & Tech Co., Ltd  
Tel: +86-755 2523 4088 E-mail: [agc@agccert.com](mailto:agc@agccert.com) Web: <http://www.agccert.com/>



### REPORT REVISE RECORD

Report Version	Revise Time	Issued Date	Valid Version	Notes
V1.0	/	Feb. 23, 2023	Valid	Initial Release

Any report having not been signed by authorized approver, or having been altered without authorization, or having not been stamped by the "Dedicated Testing/Inspection Stamp" is deemed to be invalid. Copying or excerpting portion of, or altering the content of the report is not permitted without the written authorization of AGC. The test results presented in the report apply only to the tested sample. Any objections to report issued by AGC should be submitted to AGC within 15days after the issuance of the test report. Further enquiry of validity or verification of the test report should be addressed to AGC by [agc01@agccert.com](mailto:agc01@agccert.com).

**TABLE OF CONTENTS**

**1. VERIFICATION OF CONFORMITY..... 5**

**2. GENERAL INFORMATION ..... 6**

2.1. PRODUCT DESCRIPTION..... 6

2.2. TABLE OF CARRIER FREQUENCIES..... 7

2.3. RELATED SUBMITTAL(S) / GRANT (S) ..... 10

2.4. TEST METHODOLOGY..... 10

2.5. SPECIAL ACCESSORIES ..... 10

2.6. EQUIPMENT MODIFICATIONS ..... 10

2.7. ANTENNA REQUIREMENT ..... 10

2.8. DESCRIPTION OF AVAILABLE ANTENNAS ..... 11

**3. TEST ENVIRONMENT ..... 12**

3.1 ADDRESS OF THE TEST LABORATORY ..... 12

3.2 TEST FACILITY..... 12

3.3 ENVIRONMENTAL CONDITIONS..... 13

3.4 MEASUREMENT UNCERTAINTY..... 13

3.5 LIST OF EQUIPMENTS USED..... 14

**4. DESCRIPTION OF TEST MODES ..... 15**

**5. SYSTEM TEST CONFIGURATION ..... 16**

5.1. CONFIGURATION OF EUT SYSTEM..... 16

5.2. EQUIPMENT USED IN EUT SYSTEM..... 16

5.3. SUMMARY OF TEST RESULTS ..... 16

**6. RF OUTPUT POWER MEASUREMENT..... 17**

6.1 MEASUREMENT LIMITS ..... 17

6.2 MEASUREMENT PROCEDURE ..... 17

6.3 MEASUREMENT SETUP (BLOCK DIAGRAM OF CONFIGURATION) ..... 18

6.4 MEASUREMENT RESULT ..... 18

**7. 6DB&26DB BANDWIDTH MEASUREMENT ..... 30**

7.1 MEASUREMENT LIMITS ..... 30

7.2 MEASUREMENT PROCEDURE ..... 30

7.3 MEASUREMENT SETUP (BLOCK DIAGRAM OF CONFIGURATION) ..... 30

7.4 MEASUREMENT RESULTS..... 31

**8. POWER SPECTRAL DENSITY MEASUREMENT ..... 148**

8.1 MEASUREMENT LIMITS ..... 148

8.2 MEASUREMENT PROCEDURE ..... 148

8.3 MEASUREMENT SETUP (BLOCK DIAGRAM OF CONFIGURATION) ..... 148

8.4 MEASUREMENT RESULT ..... 149

Any report having not been signed by authorized approver, or having been altered without authorization, or having not been stamped by the “Dedicated Testing/Inspection Stamp” is deemed to be invalid. Copying or excerpting portion of, or altering the content of the report is not permitted without the written authorization of AGC. The test results presented in the report apply only to the tested sample. Any objections to report issued by AGC should be submitted to AGC within 15days after the issuance of the test report. Further enquiry of validity or verification of the test report should be addressed to AGC by agc01@agccert.com.

<b>9. CONDUCTED SPURIOUS EMISSION.....</b>	<b>246</b>
9.1 MEASUREMENT LIMIT .....	246
9.2 MEASUREMENT PROCEDURE .....	246
9.3 MEASUREMENT SETUP (BLOCK DIAGRAM OF CONFIGURATION) .....	246
9.4 MEASUREMENT RESULTS.....	247
<b>10. RADIATED EMISSION .....</b>	<b>355</b>
10.1 LIMITS OF RADIATED EMISSION TEST .....	355
10.2 MEASUREMENT PROCEDURE .....	356
10.3 MEASUREMENT SETUP (BLOCK DIAGRAM OF CONFIGURATION).....	358
10.4 MEASUREMENT RESULT .....	359
<b>11. AC POWER LINE CONDUCTED EMISSION TEST .....</b>	<b>404</b>
11.1. LIMITS OF LINE CONDUCTED EMISSION TEST .....	404
11.2. BLOCK DIAGRAM OF LINE CONDUCTED EMISSION TEST .....	404
11.3. PRELIMINARY PROCEDURE OF LINE CONDUCTED EMISSION TEST .....	405
11.4. FINAL PROCEDURE OF LINE CONDUCTED EMISSION TEST .....	405
11.5. TEST RESULT OF LINE CONDUCTED EMISSION TEST .....	406
<b>APPENDIX I: PHOTOGRAPHS OF TEST SETUP .....</b>	<b>408</b>
<b>APPENDIX II: PHOTOGRAPHS OF EUT .....</b>	<b>408</b>

Any report having not been signed by authorized approver, or having been altered without authorization, or having not been stamped by the “Dedicated Testing/Inspection Stamp” is deemed to be invalid. Copying or excerpting portion of, or altering the content of the report is not permitted without the written authorization of AGC. The test results presented in the report apply only to the tested sample. Any objections to report issued by AGC should be submitted to AGC within 15days after the issuance of the test report. Further enquiry of validity or verification of the test report should be addressed to AGC by [agc01@agccert.com](mailto:agc01@agccert.com).

### 1. VERIFICATION OF CONFORMITY

<b>Applicant</b>	AGM MOBILE LIMITED
<b>Address</b>	FLAT/RM 2253 22/F HOI TAI FACTORY ESTATE TSING YEUNG CIRCUIT TUEN MUN NT HONG KONG
<b>Manufacturer</b>	Shenzhen AIJEMO Technology Company Limited
<b>Address</b>	1st Floor 101 and 2nd Floor 201, Building A2, Huafeng Century Technology Park, Nanchang Community, Xixiang, Baoan District, Shenzhen, China
<b>Factory</b>	Shenzhen AIJEMO Technology Company Limited
<b>Address</b>	1st Floor 101 and 2nd Floor 201, Building A2, Huafeng Century Technology Park, Nanchang Community, Xixiang, Baoan District, Shenzhen, China
<b>Product Designation</b>	5G Smart phone
<b>Brand Name</b>	AGM
<b>Test Model</b>	AGM G2
<b>Series Model</b>	AGM G2 Pro, AGM G2 Guardian, AGM G2 1KM, Glory G2
<b>Declaration of Difference</b>	All the same except the model name
<b>Date of receipt of test item</b>	Dec. 28, 2022
<b>Date of test</b>	Dec. 28, 2022~Feb. 23, 2023
<b>Deviation</b>	No any deviation from the test method
<b>Condition of Test Sample</b>	Normal
<b>Test Result</b>	Pass
<b>Report Template</b>	AGCRT-US-BGN/RF

We hereby certify that:

The above equipment was tested by Attestation of Global Compliance (Shenzhen) Co., Ltd. The test data, data evaluation, test procedures, and equipment configurations shown in this report were made in accordance with the procedures given in ANSI C63.10 (2013) and the energy emitted by the sample EUT tested as described in this report is in compliance with requirement of FCC Part 15 Rules requirement.

Prepared By

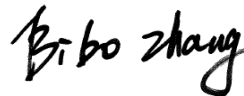

Bibo Zhang  
(Project Engineer)

Feb. 23, 2023

Reviewed By



Calvin Liu  
(Reviewer)

Feb. 23, 2023

Approved By



Max Zhang  
Authorized Officer

Feb. 23, 2023

Any report having not been signed by authorized approver, or having been altered without authorization, or having not been stamped by the "Dedicated Testing/Inspection Stamp" is deemed to be invalid. Copying or excerpting portion of, or altering the content of the report is not permitted without the written authorization of AGC. The test results presented in the report apply only to the tested sample. Any objections to report issued by AGC should be submitted to AGC within 15days after the issuance of the test report. Further enquiry of validity or verification of the test report should be addressed to AGC by agc01@agccert.com.

## 2. GENERAL INFORMATION

### 2.1. PRODUCT DESCRIPTION

<b>Equipment Type</b>	<input type="checkbox"/> Outdoor access points <input type="checkbox"/> Indoor access points <input type="checkbox"/> Fixed P2P access points <input checked="" type="checkbox"/> Client devices
<b>Operation Frequency</b>	<input checked="" type="checkbox"/> U-NII 1:5150MHz~5250MHz <input checked="" type="checkbox"/> U-NII 2A: 5250MHz~5350MHz <input checked="" type="checkbox"/> U-NII 2C:5470MHz~5725MHz <input checked="" type="checkbox"/> U-NII 3: 5725MHz~5850MHz
<b>DFS Design Type</b>	<input type="checkbox"/> Master <input type="checkbox"/> Slave with radar detection <input checked="" type="checkbox"/> Slave without radar detection
<b>TPC Function</b>	<input type="checkbox"/> Yes <input checked="" type="checkbox"/> No
<b>Hardware Version</b>	V1.00
<b>Software Version</b>	N2060.6.01.00.00
<b>Test Frequency Range</b>	For 802.11a/n-HT20/ac-VHT20: 5180~5240MHz, 5260~5320MHz, 5500~5720MHz, 5745~5825MHz For 802.11n-HT40/ac-VHT40: 5190~5230MHz, 5270~5310MHz, 5510~5710MHz, 5755~5795MHz For 802.11ac-VHT80: 5210MHz, 5290MHz, 5530~5690MHz, 5775MHz
<b>Output Power</b>	IEEE 802.11a(HT20):14.08dBm; IEEE 802.11n(HT20):13.61dBm; IEEE802.11n(HT40):13.46dBm; IEEE 802.11ac(VHT20):13.22dBm; IEEE802.11ac(VHT40):13.83dBm; IEEE802.11ac(VHT80):13.55dBm; IEEE802.11ax(HE20):10.96dBm; IEEE802.11ax(HE40):10.12dBm; IEEE802.11ax(HE80):8.80dBm
<b>Output Power_MIMO</b>	IEEE 802.11nHT(20):15.79dBm;IEEE802.11n(HT40):15.45dBm IEEE 802.11ac(VHT20):15.24dBm; IEEE802.11ac(VHT40):15.33dBm; IEEE802.11ac(VHT80):14.70dBm;IEEE802.11ax(HE20):13.12dBm; IEEE802.11ax(HE40):12.41dBm;IEEE802.11ax(HE80):11.62dBm
<b>Modulation</b>	802.11a/n:(64-QAM, 16-QAM, QPSK, BPSK) OFDM 802.11ac :(256-QAM, 64-QAM, 16-QAM, QPSK, BPSK) OFDM 802.11ax :(1024-QAM,256-QAM, 64-QAM, 16-QAM, QPSK, BPSK) OFDMA
<b>Data Rate</b>	802.11a:6/9/12/18/24/36/48/54Mbps; 802.11n:up to 300Mbps; 802.11ac:up to 866.6Mbps; 802.11ax:up to 1201Mbps
<b>Number of channels</b>	7 channels of U-NII-1 Band 7 channels of U- NII-2A Band 12 channels of U-NII-2C Band 8 channels of U- NII 3 Band
<b>Antenna Designation</b>	PIFA Antenna
<b>Antenna Gain</b>	Refer to Chapter 2.8 of the report.
<b>Power Supply</b>	DC 3.85V by battery

Any report having not been signed by authorized approver, or having been altered without authorization, or having not been stamped by the "Dedicated Testing/Inspection Stamp" is deemed to be invalid. Copying or excerpting portion of, or altering the content of the report is not permitted without the written authorization of AGC. The test results presented in the report apply only to the tested sample. Any objections to report issued by AGC should be submitted to AGC within 15days after the issuance of the test report. Further enquiry of validity or verification of the test report should be addressed to AGC by agc01@agccert.com.

## 2.2. TABLE OF CARRIER FREQUENCIES

For 5180~5240MHz:

4 channels are provided for 802.11a, 802.11n (HT20), 802.11ac (VHT20), 802.11ax (HE20):

Channel	Frequency	Channel	Frequency
36	5180 MHz	44	5220 MHz
40	5200 MHz	48	5240 MHz

2 channels are provided for 802.11n (HT40), 802.11ac (VHT40), 802.11ax (HE40):

Channel	Frequency	Channel	Frequency
38	5190 MHz	46	5230 MHz

1 channel is provided for 802.11ac (VHT80), 802.11ax (VHT80):

Channel	Frequency	Channel	Frequency
42	5210 MHz	--	--

For 5260~5320MHz:

5 channels are provided for 802.11a, 802.11n (HT20), 802.11ac (VHT20) , 802.11ax (HE20):

Channel	Frequency	Channel	Frequency
52	5260 MHz	60	5300 MHz
56	5280 MHz	64	5320 MHz

2 channels are provided for 802.11n (HT40), 802.11ac (VHT40) , 802.11ax (HE40):

Channel	Frequency	Channel	Frequency
54	5270 MHz	62	5310 MHz

1 channel is provided for 802.11ac (VHT80), 802.11ax (HE80):

Channel	Frequency	Channel	Frequency
58	5290 MHz	--	--

Any report having not been signed by authorized approver, or having been altered without authorization, or having not been stamped by the "Dedicated Testing/Inspection Stamp" is deemed to be invalid. Copying or excerpting portion of, or altering the content of the report is not permitted without the written authorization of AGC. The test results presented in the report apply only to the tested sample. Any objections to report issued by AGC should be submitted to AGC within 15days after the issuance of the test report. Further enquiry of validity or verification of the test report should be addressed to AGC by agc01@agccert.com.



**For 5500~5720MHz:**

**12 channels are provided for 802.11a, 802.11n (HT20), 802.11ac (VHT20), 802.11ax (HE20):**

Channel	Frequency	Channel	Frequency
100	5500 MHz	124	5620 MHz
104	5520 MHz	128	5640 MHz
108	5540 MHz	132	5660 MHz
112	5560 MHz	136	5680 MHz
116	5580 MHz	140	5700 MHz
120	5600 MHz	144	5720 MHz

**6 channels are provided for 802.11n (HT40), 802.11ac (VHT40), 802.11ax (HE40):**

Channel	Frequency	Channel	Frequency
102	5510 MHz	126	5630 MHz
110	5550 MHz	134	5670 MHz
118	5590 MHz	142	5710 MHz

**3 channel is provided for 802.11ac (VHT80), 802.11ax (HE80):**

Channel	Frequency	Channel	Frequency
106	5530 MHz	122	5610 MHz
138	5690 MHz	--	--

Any report having not been signed by authorized approver, or having been altered without authorization, or having not been stamped by the "Dedicated Testing/Inspection Stamp" is deemed to be invalid. Copying or excerpting portion of, or altering the content of the report is not permitted without the written authorization of AGC. The test results presented in the report apply only to the tested sample. Any objections to report issued by AGC should be submitted to AGC within 15days after the issuance of the test report. Further enquiry of validity or verification of the test report should be addressed to AGC by agc01@agccert.com.



**For 5745~5825MHz:**

**5 channels are provided for 802.11a, 802.11n (HT20), 802.11ac (VHT20) , 802.11ax (HE20):**

Channel	Frequency	Channel	Frequency
149	5745 MHz	161	5805 MHz
153	5765 MHz	165	5825 MHz
157	5785 MHz	--	--

**2 channels are provided for 802.11n (HT40), 802.11ac (VHT40) , 802.11ax (HE40):**

Channel	Frequency	Channel	Frequency
151	5755 MHz	159	5795 MHz

**1 channel is provided for 802.11ac (VHT80) , 802.11ax (HE80):**

Channel	Frequency	Channel	Frequency
155	5775 MHz	--	--

Any report having not been signed by authorized approver, or having been altered without authorization, or having not been stamped by the "Dedicated Testing/Inspection Stamp" is deemed to be invalid. Copying or excerpting portion of, or altering the content of the report is not permitted without the written authorization of AGC. The test results presented in the report apply only to the tested sample. Any objections to report issued by AGC should be submitted to AGC within 15days after the issuance of the test report. Further enquiry of validity or verification of the test report should be addressed to AGC by agc01@agccert.com.

### 2.3. RELATED SUBMITTAL(S) / GRANT (S)

This submittal(s) (test report) is intended for **FCC ID: 2A3DR-G2** filing to comply with the FCC Part 15 requirements.

### 2.4. TEST METHODOLOGY

No.	Identity	Document Title
1	FCC 47 CFR Part 2	Frequency allocations and radio treaty matters; general rules and regulations
2	FCC 47 CFR Part 15	Radio Frequency Devices
3	ANSI C63.10-2013	American National Standard for Testing Unlicensed Wireless Devices
4	KDB 662911	662911 D01 Multiple Transmitter Output v02r01
5	KDB 789033	789033 D02 General U-NII Test Procedures New Rules v02r01

### 2.5. SPECIAL ACCESSORIES

Refer to section 5.2.

### 2.6. EQUIPMENT MODIFICATIONS

Not available for this EUT intended for grant.

### 2.7. ANTENNA REQUIREMENT

Standard Requirement
<p><b>15.203 requirement:</b> An intentional radiator shall be designed to ensure that no antenna other than that furnished by the responsible party shall be used with the device. The use of a permanently attached antenna or of an antenna that uses a unique coupling to the intentional radiator, the manufacturer may design the unit so that a broken antenna can be replaced by the user, but the use of a standard antenna jack or electrical connector is prohibited.</p>
<p><b>EUT Antenna:</b> The non-detachable antenna inside the device cannot be replaced by the user at will. The gain of the antenna refer to Section 2.8 of the report</p>

Any report having not been signed by authorized approver, or having been altered without authorization, or having not been stamped by the "Dedicated Testing/Inspection Stamp" is deemed to be invalid. Copying or excerpting portion of, or altering the content of the report is not permitted without the written authorization of AGC. The test results presented in the report apply only to the tested sample. Any objections to report issued by AGC should be submitted to AGC within 15 days after the issuance of the test report. Further enquiry of validity or verification of the test report should be addressed to AGC by agc01@agccert.com.

## 2.8. DESCRIPTION OF AVAILABLE ANTENNAS

Antenna Type	Frequency Band (MHz)	TX Paths	Bandwidth (MHz)	Max Peak Gain (dBi)		Max Directional Gain (dBi)
				Ant 1	Ant 2	
5G WIFI PIFA Antenna List (5GHz 2*2 MIMO)						
PIFA Antenna	5150 ~ 5250	2	20,40,80	1.23	-1.0	4.23
	5280 ~ 5350	2	20,40,80	1.23	-1.0	4.23
	5470 ~ 5725	2	20,40,80	1.23	2.0	5.01
	5725 ~ 5850	2	20,40,80	1.23	0.9	4.23

Note 1: The EUT supports Cyclic Delay Diversity (CDD) technology for 802.11n/ac/ax mode.

Note 2: The EUT supports Cyclic Delay Diversity (CDD) mode, and CDD signals are correlated.

If all antennas have the same gain,  $G_{ANT}$ , Directional gain =  $G_{ANT} + \text{Array Gain}$ , where Array Gain is as follows.

- For power spectral density (PSD) measurements on devices:

$$\text{Array Gain} = 10 \log (N_{ANT} / N_{SS}) \text{ dB} = 3.01;$$

- For power measurements on IEEE 802.1 devices:

$$\text{Array Gain} = 0 \text{ dB for } N_{ANT} \leq 4;$$

$$\text{Array Gain} = 0 \text{ dB (i.e., no array gain) for channel widths } \geq 40 \text{ MHz for any } N_{ANT};$$

$$\text{Array Gain} = 5 \log(N_{ANT}/N_{SS}) \text{ dB or } 3 \text{ dB, whichever is less, for } 20 \text{ MHz channel widths with } N_{ANT} \geq 5.$$

If antenna gains are not equal, Directional gain may be calculated by using the formulas applicable to equal gain antennas with  $G_{ANT}$  set equal to the gain of the antenna having the highest gain.

### 3. TEST ENVIRONMENT

#### 3.1 ADDRESS OF THE TEST LABORATORY

Laboratory: Attestation of Global Compliance (Shenzhen) Co., Ltd.

Address: 1-2/F, Building 19, Junfeng Industrial Park, Chongqing Road, Heping Community, Fuhai Street, Bao'an District, Shenzhen, Guangdong, China

#### 3.2 TEST FACILITY

The test facility is recognized, certified, or accredited by the following organizations:

##### **CNAS-Lab Code: L5488**

Attestation of Global Compliance (Shenzhen) Co., Ltd. has been assessed and proved to be in compliance with CNAS-CL01 Accreditation Criteria for Testing and Calibration Laboratories (identical to ISO/IEC17025: 2017 General Requirements) for the Competence of Testing and Calibration Laboratories.

##### **A2LA-Lab Cert. No.: 5054.02**

Attestation of Global Compliance (Shenzhen) Co., Ltd. EMC Laboratory has been accredited by A2LA for technical competence in the field of electrical testing, and proved to be in compliance with ISO/IEC 17025: 2017 General Requirements for the Competence of Testing and Calibration Laboratories and any additional program requirements in the identified field of testing.

##### **FCC-Registration No.: 975832**

Attestation of Global Compliance (Shenzhen) Co., Ltd. EMC Laboratory has been registered and fully described in a report filed with the FCC (Federal Communications Commission). The acceptance letter from the FCC is maintained in our files with Registration 975832.

##### **IC-Registration No.: 24842 (CAB identifier: CN0063)**

Attestation of Global Compliance (Shenzhen) Co., Ltd. EMC Laboratory has been registered and fully described in a report filed with the Certification and Engineering Bureau of Industry Canada. The acceptance letter from the IC is maintained in our files with Registration 24842.

Any report having not been signed by authorized approver, or having been altered without authorization, or having not been stamped by the "Dedicated Testing/Inspection Stamp" is deemed to be invalid. Copying or excerpting portion of, or altering the content of the report is not permitted without the written authorization of AGC. The test results presented in the report apply only to the tested sample. Any objections to report issued by AGC should be submitted to AGC within 15days after the issuance of the test report. Further enquiry of validity or verification of the test report should be addressed to AGC by [agc01@agccert.com](mailto:agc01@agccert.com).

### 3.3 ENVIRONMENTAL CONDITIONS

	NORMAL CONDITIONS	EXTREME CONDITIONS
Temperature range (°C)	15 - 35	-20 - 50
Relative humidity range	20 % - 75 %	20 % - 75 %
Pressure range (kPa)	86 - 106	86 - 106
Power supply	DC 3.85V	--

Note: The Extreme Temperature and Extreme Voltages declared by the manufacturer.

### 3.4 MEASUREMENT UNCERTAINTY

The reported uncertainty of measurement  $y \pm U$ , where expanded uncertainty  $U$  is based on a standard uncertainty multiplied by a coverage factor of  $k=2$ , providing a level of confidence of approximately 95%.

Item	Measurement Uncertainty
Uncertainty of Conducted Emission for AC Port	$U_c = \pm 3.1$ dB
Uncertainty of Radiated Emission below 1GHz	$U_c = \pm 4.0$ dB
Uncertainty of Radiated Emission above 1GHz	$U_c = \pm 4.8$ dB
Uncertainty of total RF power, conducted	$U_c = \pm 0.8$ dB
Uncertainty of RF power density, conducted	$U_c = \pm 2.6$ dB
Uncertainty of spurious emissions, conducted	$U_c = \pm 2$ %
Uncertainty of Occupied Channel Bandwidth	$U_c = \pm 2.7$ %

Any report having not been signed by authorized approver, or having been altered without authorization, or having not been stamped by the "Dedicated Testing/Inspection Stamp" is deemed to be invalid. Copying or excerpting portion of, or altering the content of the report is not permitted without the written authorization of AGC. The test results presented in the report apply only to the tested sample. Any objections to report issued by AGC should be submitted to AGC within 15days after the issuance of the test report. Further enquiry of validity or verification of the test report should be addressed to AGC by [agc01@agccert.com](mailto:agc01@agccert.com).

### 3.5 LIST OF EQUIPMENTS USED

#### TEST EQUIPMENT OF CONDUCTED EMISSION TEST

Equipment	Manufacturer	Model	S/N	Cal. Date	Cal. Due
TEST RECEIVER	R&S	ESPI	101206	Aug. 04, 2022	Aug. 03, 2023
LISN	R&S	ESH2-Z5	100086	Jun. 08, 2022	Jun. 07, 2023
Test software	R&S	ES-K1	Ver.V1.71	N/A	N/A

#### TEST EQUIPMENT OF RADIATED EMISSION TEST

Equipment	Manufacturer	Model	S/N	Cal. Date	Cal. Due
TEST RECEIVER	R&S	ESCI	10096	Mar. 28, 2022	Mar. 27, 2023
EXA Signal Analyzer	Aglient	N9010A	MY53470504	Aug. 04, 2022	Aug. 03, 2023
Power sensor	Aglient	U2021XA	MY54110007	Mar. 04, 2022	Mar. 02, 2023
5GHz Fliter	EM Electronics	5150-5880MHz	N/A	N/A	N/A
Attenuator	ZHINAN	E-002	N/A	Sep. 01, 2022	Aug. 31, 2023
Horn antenna	SCHWARZBECK	BBHA 9170	#768	Oct. 31, 2021	Oct. 30, 2023
Active loop antenna (9K-30MHz)	ZHINAN	ZN30900C	18051	Mar. 12, 2022	Mar. 11, 2023
Double-Ridged Waveguide Horn	ETS LINDGREN	3117	00034609	Apr. 23, 2021	Apr. 22, 2023
Broadband Preamplifier	ETS LINDGREN	3117PA	00225134	Sep. 01, 2022	Aug. 31, 2023
ANTENNA	SCHWARZBECK	VULB9168	494	Jan. 07, 2021	Jan. 06, 2023
ANTENNA	SCHWARZBECK	VULB9168	494	Jan. 05, 2023	Jan. 04, 2025
Test software	Tonscend	JS32-RE	Ver.2.5	N/A	N/A

Any report having not been signed by authorized approver, or having been altered without authorization, or having not been stamped by the "Dedicated Testing/Inspection Stamp" is deemed to be invalid. Copying or excerpting portion of, or altering the content of the report is not permitted without the written authorization of AGC. The test results presented in the report apply only to the tested sample. Any objections to report issued by AGC should be submitted to AGC within 15days after the issuance of the test report. Further enquiry of validity or verification of the test report should be addressed to AGC by agc01@agccert.com.

#### 4. DESCRIPTION OF TEST MODES

Mode	Available channel	Tested channel	Modulation	Date rate (Mbps)
802.11a/n/ac/ax20	Refer to Section 2.2	36,40,48,52,60,64,100 116,140,149,157,165	OFDM/OFDMA	6Mbps/MCS0
802.11n/ac/ax40		38,46,54,62,102 110,134,151,159	OFDM/OFDMA	MCS0
802.11ac/ax80		42,58,106,121,155	OFDM/OFDMA	MCS0

**Note:**

1. The EUT has been set to operate continuously on tested channel individually, and the EUT is operating at its maximum duty cycle>or equal 98%.
2. All modes under which configure applicable have been tested and the worst mode test data recording in the test report, if no other mode data.

#### Software Setting

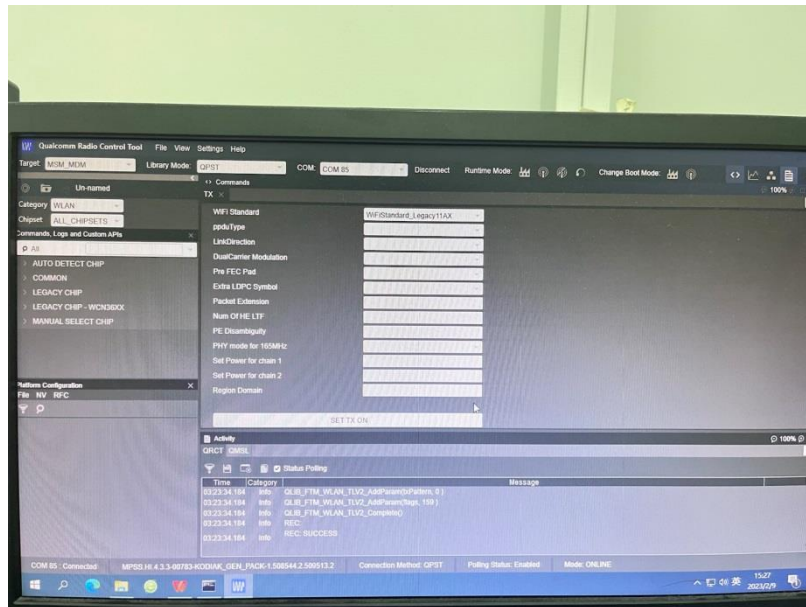

Any report having not been signed by authorized approver, or having been altered without authorization, or having not been stamped by the “Dedicated Testing/Inspection Stamp” is deemed to be invalid. Copying or excerpting portion of, or altering the content of the report is not permitted without the written authorization of AGC. The test results presented in the report apply only to the tested sample. Any objections to report issued by AGC should be submitted to AGC within 15days after the issuance of the test report. Further enquiry of validity or verification of the test report should be addressed to AGC by agc01@agccert.com.



## 5. SYSTEM TEST CONFIGURATION

### 5.1. CONFIGURATION OF EUT SYSTEM

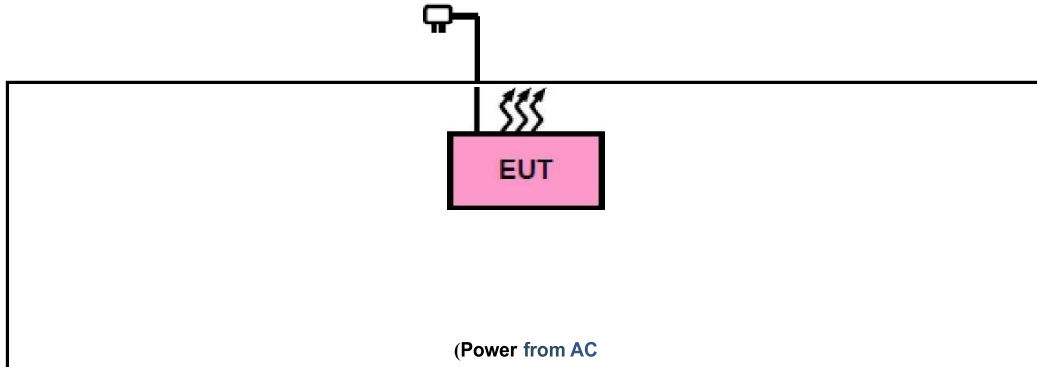

### 5.2. EQUIPMENT USED IN EUT SYSTEM

Item	Equipment	Model No.	ID or Specification	Remark
1	5G Smart phone	AGM G2	2A3DR-G2	EUT
2	Adapter	U312QC1801	Input: AC 100-240V 50/60Hz, 0.5A Output: DC 5V 3A, 9V 2A, 12V 1.5A	AE
3	Battery	Glory G2	DC 3.85V 7000mAh	AE
4	USB Cable	N/A	N/A	AE

### 5.3. SUMMARY OF TEST RESULTS

Item	FCC Rules	Description Of Test	Result
1	§15.203	Antenna Equipment	Pass
2	§15.407(a/1/2/3)	RF Output Power	Pass
3	§15.407(e)	6dB Bandwidth Measurement	Pass
4	§2.1049	26dB bandwidth Measurement	Pass
5	§15.407(a/1/2/3)	Power Spectral Density	Pass
6	§15.407(b)(1/2/3/4/5)	Conducted Spurious Emission	Pass
7	§15.407(b)(1/2/3/4/5)	Radiated Emission& Band Edge	Pass
8	§15.407(b)(6)	AC Power Line Conducted Emission	Pass

Any report having not been signed by authorized approver, or having been altered without authorization, or having not been stamped by the "Dedicated Testing/Inspection Stamp" is deemed to be invalid. Copying or excerpting portion of, or altering the content of the report is not permitted without the written authorization of AGC. The test results presented in the report apply only to the tested sample. Any objections to report issued by AGC should be submitted to AGC within 15days after the issuance of the test report. Further enquiry of validity or verification of the test report should be addressed to AGC by agc01@agccert.com.

## 6. RF OUTPUT POWER MEASUREMENT

### 6.1 MEASUREMENT LIMITS

Operation Band	EUT Category		LIMIT
U-NII-1	<input type="checkbox"/>	Outdoor Access Point	1 Watt (30 dBm) (Max. e.i.r.p < 125mW(21 dBm) at any elevation angle above 30 degrees as measured from the horizon)
	<input type="checkbox"/>	Fixed point-to-point Access Point	1 Watt (30 dBm)
	<input type="checkbox"/>	Indoor Access Point	1 Watt (30 dBm)
	<input checked="" type="checkbox"/>	Client devices	250mW (23.98 dBm)
U-NII-2A	/		250mW (23.98 dBm) or 11 dBm+10 log B*
U-NII-2C	/		250mW (23.98 dBm) or 11 dBm+10 log B*
U-NII-3	/		1 Watt (30 dBm)

Note: Where B is the 26dB emission bandwidth in MHz.

### 6.2 MEASUREMENT PROCEDURE

Method PM is Measurement using an RF average power meter. The procedure for this method is as follows:

1. The testing follows the ANSI C63.10 Section 12.3.3.1
2. Measurements may be performed using a wideband RF power meter with a thermocouple detector or equivalent if all of the following conditions are satisfied:
3. The EUT is configured to transmit continuously, or to transmit with a constant duty cycle.
4. At all times when the EUT is transmitting, it shall be transmitting at its maximum power control level.
5. The integration period of the power meter exceeds the repetition period of the transmitted signal by at least a factor of five.
6. Determine according to the duty cycle of the equipment: when it is less than 98%, follow the steps below.
7. Measure the average power of the transmitter. This measurement is an average over both the ON and OFF periods of the transmitter.
8. Adjust the measurement in dBm by adding  $[10 \log (1 / D)]$ , where D is the duty cycle {e.g.,  $[10 \log (1 / 0.25)]$ , if the duty cycle is 25%}.
9. Record the test results in the report.

Any report having not been signed by authorized approver, or having been altered without authorization, or having not been stamped by the "Dedicated Testing/Inspection Stamp" is deemed to be invalid. Copying or excerpting portion of, or altering the content of the report is not permitted without the written authorization of AGC. The test results presented in the report apply only to the tested sample. Any objections to report issued by AGC should be submitted to AGC within 15days after the issuance of the test report. Further enquiry of validity or verification of the test report should be addressed to AGC by agc01@agccert.com.

### 6.3 MEASUREMENT SETUP (BLOCK DIAGRAM OF CONFIGURATION)

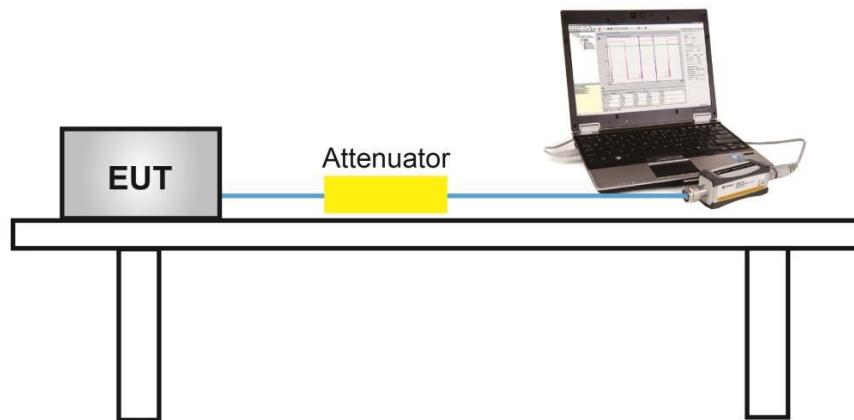

### 6.4 MEASUREMENT RESULT

Test Data of Conducted Output Power for band 5.15-5.25 GHz-ANT 1				
Test Mode	Test Channel (MHz)	Average Power (dBm)	Limits (dBm)	Pass or Fail
802.11a	5180	13.84	23.98	Pass
	5200	13.75	23.98	Pass
	5240	<b>14.08</b>	23.98	Pass
802.11n20	5180	13.40	23.98	Pass
	5200	13.33	23.98	Pass
	5240	<b>13.61</b>	23.98	Pass
802.11n40	5190	<b>13.46</b>	23.98	Pass
	5230	13.17	23.98	Pass
802.11ac20	5180	13.17	23.98	Pass
	5200	12.94	23.98	Pass
	5240	<b>13.22</b>	23.98	Pass
802.11ac40	5190	13.63	23.98	Pass
	5230	<b>13.83</b>	23.98	Pass
802.11ac80	5210	<b>13.55</b>	23.98	Pass
802.11ax20	5180	8.43	23.98	Pass
	5200	9.60	23.98	Pass
	5240	10.95	23.98	Pass
802.11ax40	5190	8.20	23.98	Pass
	5230	10.02	23.98	Pass
802.11ax80	5210	8.04	23.98	Pass

Any report having not been signed by authorized approver, or having been altered without authorization, or having not been stamped by the "Dedicated Testing/Inspection Stamp" is deemed to be invalid. Copying or excerpting portion of, or altering the content of the report is not permitted without the written authorization of AGC. The test results presented in the report apply only to the tested sample. Any objections to report issued by AGC should be submitted to AGC within 15days after the issuance of the test report. Further enquiry of validity or verification of the test report should be addressed to AGC by agc01@agccert.com.

Test Data of Conducted Output Power for band 5.15-5.25 GHz-ANT 2				
Test Mode	Test Channel (MHz)	Average Power (dBm)	Limits (dBm)	Pass or Fail
802.11a	5180	12.19	23.98	Pass
	5200	12.01	23.98	Pass
	5240	11.05	23.98	Pass
802.11n20	5180	12.05	23.98	Pass
	5200	12.03	23.98	Pass
	5240	11.03	23.98	Pass
802.11n40	5190	11.10	23.98	Pass
	5230	10.09	23.98	Pass
802.11ac20	5180	11.02	23.98	Pass
	5200	10.37	23.98	Pass
	5240	9.65	23.98	Pass
802.11ac40	5190	10.04	23.98	Pass
	5230	10.00	23.98	Pass
802.11ac80	5210	8.36	23.98	Pass
802.11ax20	5180	10.00	23.98	Pass
	5200	10.01	23.98	Pass
	5240	8.93	23.98	Pass
802.11ax40	5190	9.20	23.98	Pass
	5230	8.03	23.98	Pass
802.11ax80	5210	7.86	23.98	Pass

Any report having not been signed by authorized approver, or having been altered without authorization, or having not been stamped by the "Dedicated Testing/Inspection Stamp" is deemed to be invalid. Copying or excerpting portion of, or altering the content of the report is not permitted without the written authorization of AGC. The test results presented in the report apply only to the tested sample. Any objections to report issued by AGC should be submitted to AGC within 15days after the issuance of the test report. Further enquiry of validity or verification of the test report should be addressed to AGC by agc01@agccert.com.

Test Data of Conducted Output Power for band 5.25-5.35 GHz-ANT 1				
Test Mode	Test Channel (MHz)	Average Power (dBm)	Limits (dBm)	Pass or Fail
802.11a	5260	11.69	23.98	Pass
	5300	10.20	23.98	Pass
	5320	11.56	23.98	Pass
802.11n20	5260	11.37	23.98	Pass
	5300	9.70	23.98	Pass
	5320	10.38	23.98	Pass
802.11n40	5270	10.53	23.98	Pass
	5310	10.05	23.98	Pass
802.11ac20	5260	10.70	23.98	Pass
	5300	8.91	23.98	Pass
	5320	9.09	23.98	Pass
802.11ac40	5270	10.18	23.98	Pass
	5310	9.09	23.98	Pass
802.11ac80	5290	8.81	23.98	Pass
802.11ax20	5260	9.92	23.98	Pass
	5300	8.15	23.98	Pass
	5320	8.43	23.98	Pass
802.11ax40	5270	8.96	23.98	Pass
	5310	7.16	23.98	Pass
802.11ax80	5290	7.66	23.98	Pass

Any report having not been signed by authorized approver, or having been altered without authorization, or having not been stamped by the "Dedicated Testing/Inspection Stamp" is deemed to be invalid. Copying or excerpting portion of, or altering the content of the report is not permitted without the written authorization of AGC. The test results presented in the report apply only to the tested sample. Any objections to report issued by AGC should be submitted to AGC within 15days after the issuance of the test report. Further enquiry of validity or verification of the test report should be addressed to AGC by agc01@agccert.com.

Test Data of Conducted Output Power for band 5.25-5.35 GHz-ANT 2				
Test Mode	Test Channel (MHz)	Average Power (dBm)	Limits (dBm)	Pass or Fail
802.11a	5260	11.95	23.98	Pass
	5300	11.39	23.98	Pass
	5320	11.14	23.98	Pass
802.11n20	5260	10.71	23.98	Pass
	5300	10.09	23.98	Pass
	5320	9.73	23.98	Pass
802.11n40	5270	10.20	23.98	Pass
	5310	9.45	23.98	Pass
802.11ac20	5260	9.66	23.98	Pass
	5300	9.79	23.98	Pass
	5320	9.33	23.98	Pass
802.11ac40	5270	9.15	23.98	Pass
	5310	9.04	23.98	Pass
802.11ac80	5290	8.53	23.98	Pass
802.11ax20	5260	9.22	23.98	Pass
	5300	8.45	23.98	Pass
	5320	8.43	23.98	Pass
802.11ax40	5270	8.34	23.98	Pass
	5310	7.66	23.98	Pass
802.11ax80	5290	7.37	23.98	Pass

Any report having not been signed by authorized approver, or having been altered without authorization, or having not been stamped by the "Dedicated Testing/Inspection Stamp" is deemed to be invalid. Copying or excerpting portion of, or altering the content of the report is not permitted without the written authorization of AGC. The test results presented in the report apply only to the tested sample. Any objections to report issued by AGC should be submitted to AGC within 15days after the issuance of the test report. Further enquiry of validity or verification of the test report should be addressed to AGC by agc01@agccert.com.

**Test Data of Conducted Output Power for band 5.470-5.725 GHz-ANT 1**

Test Mode	Test Channel (MHz)	Average Power (dBm)	Limits (dBm)	Pass or Fail
802.11a	5500	12.38	23.98	Pass
	5600	10.61	23.98	Pass
	5700	10.63	23.98	Pass
802.11n20	5500	10.68	23.98	Pass
	5600	9.50	23.98	Pass
	5700	9.61	23.98	Pass
802.11n40	5510	10.57	23.98	Pass
	5590	8.83	23.98	Pass
	5670	12.25	23.98	Pass
802.11ac20	5500	10.80	23.98	Pass
	5600	10.06	23.98	Pass
	5700	10.04	23.98	Pass
802.11ac40	5510	9.79	23.98	Pass
	5590	8.86	23.98	Pass
	5670	8.82	23.98	Pass
802.11ac80	5530	8.73	23.98	Pass
	5610	8.49	23.98	Pass
802.11ax20	5500	10.18	23.98	Pass
	5600	9.58	23.98	Pass
	5700	<b>10.96</b>	23.98	Pass
802.11ax40	5510	9.47	23.98	Pass
	5590	9.23	23.98	Pass
	5670	<b>10.12</b>	23.98	Pass
802.11ax80	5530	8.40	23.98	Pass
	5610	<b>8.80</b>	23.98	Pass

Any report having not been signed by authorized approver, or having been altered without authorization, or having not been stamped by the "Dedicated Testing/Inspection Stamp" is deemed to be invalid. Copying or excerpting portion of, or altering the content of the report is not permitted without the written authorization of AGC. The test results presented in the report apply only to the tested sample. Any objections to report issued by AGC should be submitted to AGC within 15days after the issuance of the test report. Further enquiry of validity or verification of the test report should be addressed to AGC by agc01@agccert.com.



Test Data of Conducted Output Power for band 5.470-5.725 GHz-ANT 2				
Test Mode	Test Channel (MHz)	Average Power (dBm)	Limits (dBm)	Pass or Fail
802.11a	5500	12.27	23.98	Pass
	5600	12.17	23.98	Pass
	5700	11.62	23.98	Pass
802.11n20	5500	11.90	23.98	Pass
	5600	11.71	23.98	Pass
	5700	10.38	23.98	Pass
802.11n40	5510	11.26	23.98	Pass
	5590	11.37	23.98	Pass
	5670	10.01	23.98	Pass
802.11ac20	5500	11.26	23.98	Pass
	5600	10.66	23.98	Pass
	5700	9.43	23.98	Pass
802.11ac40	5510	10.26	23.98	Pass
	5590	10.28	23.98	Pass
	5670	9.06	23.98	Pass
802.11ac80	5530	9.24	23.98	Pass
	5610	8.95	23.98	Pass
802.11ax20	5500	10.03	23.98	Pass
	5600	10.32	23.98	Pass
	5700	8.12	23.98	Pass
802.11ax40	5510	8.87	23.98	Pass
	5590	9.57	23.98	Pass
	5670	7.68	23.98	Pass
802.11ax80	5530	8.81	23.98	Pass
	5610	7.73	23.98	Pass

Any report having not been signed by authorized approver, or having been altered without authorization, or having not been stamped by the "Dedicated Testing/Inspection Stamp" is deemed to be invalid. Copying or excerpting portion of, or altering the content of the report is not permitted without the written authorization of AGC. The test results presented in the report apply only to the tested sample. Any objections to report issued by AGC should be submitted to AGC within 15days after the issuance of the test report. Further enquiry of validity or verification of the test report should be addressed to AGC by agc01@agccert.com.

**Test Data of Conducted Output Power for band 5.725-5.850 GHz-ANT 1**

Test Mode	Test Channel (MHz)	Average Power (dBm)	Limits (dBm)	Pass or Fail
802.11a	5745	10.89	30	Pass
	5785	9.87	30	Pass
	5825	9.98	30	Pass
802.11n20	5745	10.99	30	Pass
	5785	9.52	30	Pass
	5825	9.49	30	Pass
802.11n40	5755	10.60	30	Pass
	5795	9.63	30	Pass
802.11ac20	5745	9.57	30	Pass
	5785	8.94	30	Pass
	5825	8.39	30	Pass
802.11ac40	5755	9.56	30	Pass
	5795	8.09	30	Pass
802.11ac80	5775	8.89	30	Pass
802.11ax20	5745	9.32	30	Pass
	5785	8.19	30	Pass
	5825	8.37	30	Pass
802.11ax40	5755	7.69	30	Pass
	5795	6.95	30	Pass
802.11ax80	5775	7.88	30	Pass

Any report having not been signed by authorized approver, or having been altered without authorization, or having not been stamped by the "Dedicated Testing/Inspection Stamp" is deemed to be invalid. Copying or excerpting portion of, or altering the content of the report is not permitted without the written authorization of AGC. The test results presented in the report apply only to the tested sample. Any objections to report issued by AGC should be submitted to AGC within 15days after the issuance of the test report. Further enquiry of validity or verification of the test report should be addressed to AGC by agc01@agccert.com.

**Test Data of Conducted Output Power for band 5.725-5.850 GHz-ANT 2**

Test Mode	Test Channel (MHz)	Average Power (dBm)	Limits (dBm)	Pass or Fail
802.11a	5745	10.00	30	Pass
	5785	10.86	30	Pass
	5825	11.19	30	Pass
802.11n20	5745	10.05	30	Pass
	5785	10.85	30	Pass
	5825	11.03	30	Pass
802.11n40	5755	9.47	30	Pass
	5795	10.19	30	Pass
802.11ac20	5745	9.00	30	Pass
	5785	9.82	30	Pass
	5825	9.47	30	Pass
802.11ac40	5755	8.40	30	Pass
	5795	9.60	30	Pass
802.11ac80	5775	8.06	30	Pass
802.11ax20	5745	8.07	30	Pass
	5785	9.00	30	Pass
	5825	8.85	30	Pass
802.11ax40	5755	7.54	30	Pass
	5795	7.67	30	Pass
802.11ax80	5775	7.93	30	Pass

Any report having not been signed by authorized approver, or having been altered without authorization, or having not been stamped by the "Dedicated Testing/Inspection Stamp" is deemed to be invalid. Copying or excerpting portion of, or altering the content of the report is not permitted without the written authorization of AGC. The test results presented in the report apply only to the tested sample. Any objections to report issued by AGC should be submitted to AGC within 15days after the issuance of the test report. Further enquiry of validity or verification of the test report should be addressed to AGC by agc01@agccert.com.

Test Data of Conducted Output Power for band 5.15-5.25 GHz-MIMO				
Test Mode	Test Channel (MHz)	Average Power (dBm)	Limits (dBm)	Pass or Fail
802.11n20	5180	<b>15.79</b>	23.98	Pass
	5200	15.74	23.98	Pass
	5240	15.52	23.98	Pass
802.11n40	5190	<b>15.45</b>	23.98	Pass
	5230	14.91	23.98	Pass
802.11ac20	5180	<b>15.24</b>	23.98	Pass
	5200	14.85	23.98	Pass
	5240	14.80	23.98	Pass
802.11ac40	5190	15.21	23.98	Pass
	5230	<b>15.33</b>	23.98	Pass
802.11ac80	5210	<b>14.70</b>	23.98	Pass
802.11ax20	5180	12.30	23.98	Pass
	5200	12.82	23.98	Pass
	5240	13.07	23.98	Pass
802.11ax40	5190	11.74	23.98	Pass
	5230	12.15	23.98	Pass
802.11ax80	5210	10.96	23.98	Pass

Any report having not been signed by authorized approver, or having been altered without authorization, or having not been stamped by the "Dedicated Testing/Inspection Stamp" is deemed to be invalid. Copying or excerpting portion of, or altering the content of the report is not permitted without the written authorization of AGC. The test results presented in the report apply only to the tested sample. Any objections to report issued by AGC should be submitted to AGC within 15days after the issuance of the test report. Further enquiry of validity or verification of the test report should be addressed to AGC by agc01@agccert.com.

Test Data of Conducted Output Power for band 5.25-5.35 GHz-MIMO				
Test Mode	Test Channel (MHz)	Average Power (dBm)	Limits (dBm)	Pass or Fail
802.11n20	5260	14.06	23.98	Pass
	5300	12.91	23.98	Pass
	5320	13.08	23.98	Pass
802.11n40	5270	13.38	23.98	Pass
	5310	12.77	23.98	Pass
802.11ac20	5260	13.22	23.98	Pass
	5300	12.38	23.98	Pass
	5320	12.22	23.98	Pass
802.11ac40	5270	12.71	23.98	Pass
	5310	12.08	23.98	Pass
802.11ac80	5290	11.68	23.98	Pass
802.11ax20	5260	12.59	23.98	Pass
	5300	11.31	23.98	Pass
	5320	11.44	23.98	Pass
802.11ax40	5270	11.67	23.98	Pass
	5310	10.43	23.98	Pass
802.11ax80	5290	10.53	23.98	Pass

Any report having not been signed by authorized approver, or having been altered without authorization, or having not been stamped by the "Dedicated Testing/Inspection Stamp" is deemed to be invalid. Copying or excerpting portion of, or altering the content of the report is not permitted without the written authorization of AGC. The test results presented in the report apply only to the tested sample. Any objections to report issued by AGC should be submitted to AGC within 15days after the issuance of the test report. Further enquiry of validity or verification of the test report should be addressed to AGC by agc01@agccert.com.

**Test Data of Conducted Output Power for band 5.470-5.725 GHz-MIMO**

Test Mode	Test Channel (MHz)	Average Power (dBm)	Limits (dBm)	Pass or Fail
802.11n20	5500	14.34	23.98	Pass
	5600	13.75	23.98	Pass
	5700	13.02	23.98	Pass
802.11n40	5510	13.94	23.98	Pass
	5590	13.29	23.98	Pass
	5670	14.28	23.98	Pass
802.11ac20	5500	14.05	23.98	Pass
	5600	13.38	23.98	Pass
	5700	12.76	23.98	Pass
802.11ac40	5510	13.04	23.98	Pass
	5590	12.64	23.98	Pass
	5670	11.95	23.98	Pass
802.11ac80	5530	12.00	23.98	Pass
	5610	11.74	23.98	Pass
802.11ax20	5500	<b>13.12</b>	23.98	Pass
	5600	12.98	23.98	Pass
	5700	12.78	23.98	Pass
802.11ax40	5510	12.19	23.98	Pass
	5590	<b>12.41</b>	23.98	Pass
	5670	12.08	23.98	Pass
802.11ax80	5530	<b>11.62</b>	23.98	Pass
	5610	11.31	23.98	Pass

Any report having not been signed by authorized approver, or having been altered without authorization, or having not been stamped by the "Dedicated Testing/Inspection Stamp" is deemed to be invalid. Copying or excerpting portion of, or altering the content of the report is not permitted without the written authorization of AGC. The test results presented in the report apply only to the tested sample. Any objections to report issued by AGC should be submitted to AGC within 15days after the issuance of the test report. Further enquiry of validity or verification of the test report should be addressed to AGC by agc01@agccert.com.

Test Data of Conducted Output Power for band 5.725-5.85 GHz-MIMO				
Test Mode	Test Channel (MHz)	Average Power (dBm)	Limits (dBm)	Pass or Fail
802.11n20	5745	13.56	30	Pass
	5785	13.25	30	Pass
	5825	13.34	30	Pass
802.11n40	5755	13.08	30	Pass
	5795	12.93	30	Pass
802.11ac20	5745	12.30	30	Pass
	5785	12.41	30	Pass
	5825	11.97	30	Pass
802.11ac40	5755	12.03	30	Pass
	5795	11.92	30	Pass
802.11ac80	5775	11.51	30	Pass
802.11ax20	5745	11.75	30	Pass
	5785	11.62	30	Pass
	5825	11.63	30	Pass
802.11ax40	5755	10.63	30	Pass
	5795	10.34	30	Pass
802.11ax80	5775	10.92	30	Pass

Any report having not been signed by authorized approver, or having been altered without authorization, or having not been stamped by the "Dedicated Testing/Inspection Stamp" is deemed to be invalid. Copying or excerpting portion of, or altering the content of the report is not permitted without the written authorization of AGC. The test results presented in the report apply only to the tested sample. Any objections to report issued by AGC should be submitted to AGC within 15days after the issuance of the test report. Further enquiry of validity or verification of the test report should be addressed to AGC by agc01@agccert.com.



## 7. 6DB&26DB BANDWIDTH MEASUREMENT

### 7.1 MEASUREMENT LIMITS

The minimum 6dB bandwidth shall be at least 500 kHz.

### 7.2 MEASUREMENT PROCEDURE

7.2.1 -6dB bandwidth (DTS bandwidth) Test setting:

1. Connect EUT RF output port to the Spectrum Analyzer through an RF attenuator
2. Set the EUT Work on operation frequency individually.
3. Set RBW = 100kHz.
4. Set the VBW  $\geq 3 \times$  RBW. Detector = Peak. Trace mode = max hold.
5. Measure the maximum width of the emission that is 6 dB down from the peak of the emission.

7.2.2 99% occupied bandwidth test setting:

1. Connect EUT RF output port to the Spectrum Analyzer through an RF attenuator
2. Set the EUT Work on the top, the middle and the bottom operation frequency individually.
3. Set Span = approximately 1.5 to 5 times the OBW, centered on a nominal channel  
The nominal IF filter bandwidth (3 dB RBW) shall be in the range of 1% to 5% of the OBW and video bandwidth (VBW) shall be approximately three times RBW; Sweep = auto; Detector function = peak
4. Set SPA Trace 1 Max hold, then View.

7.2.3 -26dB Bandwidth test setting:

1. Set RBW = approximately 1% of the emission bandwidth.
2. Set the VBW > RBW.
3. Detector = Peak.
4. Trace mode = max hold.
5. Measure the maximum width of the emission that is 26 dB down from the maximum of the emission.  
Compare this with the RBW setting of the analyzer. Readjust RBW and repeat measurement as needed until the RBW/EBW ratio is approximately 1%.

**Note:** The EUT was tested according to KDB 789033 for compliance to FCC 47CFR 15.407 requirements.

### 7.3 MEASUREMENT SETUP (BLOCK DIAGRAM OF CONFIGURATION)

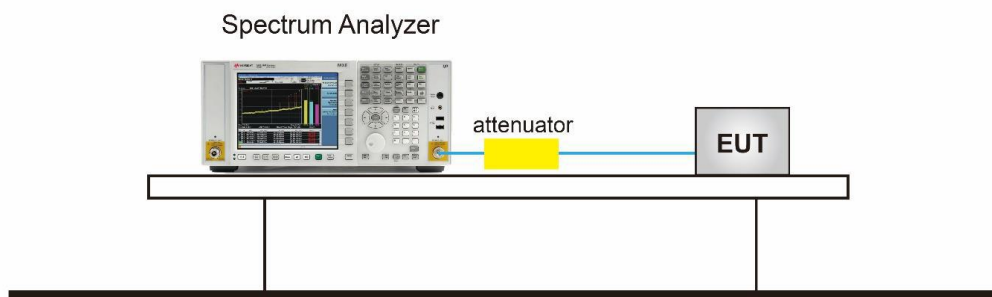

Any report having not been signed by authorized approver, or having been altered without authorization, or having not been stamped by the "Dedicated Testing/Inspection Stamp" is deemed to be invalid. Copying or excerpting portion of, or altering the content of the report is not permitted without the written authorization of AGC. The test results presented in the report apply only to the tested sample. Any objections to report issued by AGC should be submitted to AGC within 15days after the issuance of the test report. Further enquiry of validity or verification of the test report should be addressed to AGC by agc01@agccert.com.

#### 7.4 MEASUREMENT RESULTS

Test Data of Occupied Bandwidth and -26dB Bandwidth for band 5.15-5.25 GHz-ANT 1					
Test Mode	Test Channel (MHz)	99% Occupied Bandwidth (MHz)	-26dB Bandwidth (MHz)	Limits (MHz)	Pass or Fail
802.11a	5180	16.376	24.160	N/A	Pass
	5200	16.601	25.572	N/A	Pass
	5240	16.365	23.615	N/A	Pass
802.11n20	5180	17.502	20.031	N/A	Pass
	5200	17.636	26.231	N/A	Pass
	5240	17.557	22.256	N/A	Pass
802.11n40	5190	35.955	39.626	N/A	Pass
	5230	35.941	42.829	N/A	Pass
802.11ac20	5180	17.506	20.105	N/A	Pass
	5200	17.532	20.368	N/A	Pass
	5240	17.520	20.484	N/A	Pass
802.11ac40	5190	35.947	39.849	N/A	Pass
	5230	35.931	40.802	N/A	Pass
802.11ac80	5210	74.233	80.347	N/A	Pass
802.11ax20	5180	18.835	20.502	N/A	Pass
	5200	18.863	20.502	N/A	Pass
	5240	18.871	20.747	N/A	Pass
802.11ax40	5190	37.650	40.012	N/A	Pass
	5230	37.569	40.541	N/A	Pass
802.11ax80	5210	76.063	83.753	N/A	Pass

Any report having not been signed by authorized approver, or having been altered without authorization, or having not been stamped by the "Dedicated Testing/Inspection Stamp" is deemed to be invalid. Copying or excerpting portion of, or altering the content of the report is not permitted without the written authorization of AGC. The test results presented in the report apply only to the tested sample. Any objections to report issued by AGC should be submitted to AGC within 15days after the issuance of the test report. Further enquiry of validity or verification of the test report should be addressed to AGC by agc01@agccert.com.

Test Data of Occupied Bandwidth and -26dB Bandwidth for band 5.15-5.25 GHz-ANT 2					
Test Mode	Test Channel (MHz)	99% Occupied Bandwidth (MHz)	-26dB Bandwidth (MHz)	Limits (MHz)	Pass or Fail
802.11a	5180	16.250	18.311	N/A	Pass
	5200	16.250	18.347	N/A	Pass
	5240	16.241	18.377	N/A	Pass
802.11n20	5180	17.461	19.848	N/A	Pass
	5200	17.471	19.559	N/A	Pass
	5240	17.459	19.700	N/A	Pass
802.11n40	5190	35.893	39.574	N/A	Pass
	5230	36.391	41.324	N/A	Pass
802.11ac20	5180	17.563	19.550	N/A	Pass
	5200	17.561	19.666	N/A	Pass
	5240	17.572	19.527	N/A	Pass
802.11ac40	5190	35.865	38.666	N/A	Pass
	5230	35.858	38.898	N/A	Pass
802.11ac80	5210	75.029	79.735	N/A	Pass
802.11ax20	5180	18.835	20.502	N/A	Pass
	5200	18.863	20.502	N/A	Pass
	5240	18.871	20.747	N/A	Pass
802.11ax40	5190	37.650	40.012	N/A	Pass
	5230	37.569	40.541	N/A	Pass
802.11ax80	5210	76.063	83.753	N/A	Pass

Any report having not been signed by authorized approver, or having been altered without authorization, or having not been stamped by the "Dedicated Testing/Inspection Stamp" is deemed to be invalid. Copying or excerpting portion of, or altering the content of the report is not permitted without the written authorization of AGC. The test results presented in the report apply only to the tested sample. Any objections to report issued by AGC should be submitted to AGC within 15days after the issuance of the test report. Further enquiry of validity or verification of the test report should be addressed to AGC by agc01@agccert.com.

Test Data of Occupied Bandwidth and -26dB Bandwidth for band 5.25-5.35 GHz-ANT 1					
Test Mode	Test Channel (MHz)	99% Occupied Bandwidth (MHz)	-26dB Bandwidth (MHz)	Limits (MHz)	Pass or Fail
802.11a	5260	16.278	18.621	N/A	Pass
	5300	16.257	18.738	N/A	Pass
	5320	16.258	18.570	N/A	Pass
802.11n20	5260	17.496	20.046	N/A	Pass
	5300	17.490	19.909	N/A	Pass
	5320	17.499	19.841	N/A	Pass
802.11n40	5270	35.908	39.550	N/A	Pass
	5310	35.957	39.584	N/A	Pass
802.11ac20	5260	17.481	19.773	N/A	Pass
	5300	17.489	19.951	N/A	Pass
	5320	17.493	19.647	N/A	Pass
802.11ac40	5270	35.890	38.965	N/A	Pass
	5310	35.949	39.442	N/A	Pass
802.11ac80	5290	75.498	96.366	N/A	Pass
802.11ax20	5260	18.841	20.902	N/A	Pass
	5300	18.825	20.501	N/A	Pass
	5320	18.833	20.539	N/A	Pass
802.11ax40	5270	37.587	39.722	N/A	Pass
	5310	37.610	39.660	N/A	Pass
802.11ax80	5290	77.144	81.385	N/A	Pass

Any report having not been signed by authorized approver, or having been altered without authorization, or having not been stamped by the "Dedicated Testing/Inspection Stamp" is deemed to be invalid. Copying or excerpting portion of, or altering the content of the report is not permitted without the written authorization of AGC. The test results presented in the report apply only to the tested sample. Any objections to report issued by AGC should be submitted to AGC within 15days after the issuance of the test report. Further enquiry of validity or verification of the test report should be addressed to AGC by agc01@agccert.com.

Test Data of Occupied Bandwidth and -26dB Bandwidth for band 5.25-5.35 GHz-ANT 2					
Test Mode	Test Channel (MHz)	99% Occupied Bandwidth (MHz)	-26dB Bandwidth (MHz)	Limits (MHz)	Pass or Fail
802.11a	5260	16.243	18.584	N/A	Pass
	5300	16.244	18.347	N/A	Pass
	5320	16.249	18.529	N/A	Pass
802.11n20	5260	17.480	19.998	N/A	Pass
	5300	17.476	19.833	N/A	Pass
	5320	17.483	19.686	N/A	Pass
802.11n40	5270	35.871	39.209	N/A	Pass
	5310	35.887	39.100	N/A	Pass
802.11ac20	5260	17.487	19.667	N/A	Pass
	5300	17.480	20.063	N/A	Pass
	5320	17.483	19.641	N/A	Pass
802.11ac40	5270	35.884	39.170	N/A	Pass
	5310	35.868	39.396	N/A	Pass
802.11ac80	5290	74.946	80.524	N/A	Pass
802.11ax20	5260	18.815	20.752	N/A	Pass
	5300	18.839	20.584	N/A	Pass
	5320	18.824	20.799	N/A	Pass
802.11ax40	5270	37.624	39.955	N/A	Pass
	5310	37.566	39.680	N/A	Pass
802.11ax80	5290	76.766	80.505	N/A	Pass

Any report having not been signed by authorized approver, or having been altered without authorization, or having not been stamped by the "Dedicated Testing/Inspection Stamp" is deemed to be invalid. Copying or excerpting portion of, or altering the content of the report is not permitted without the written authorization of AGC. The test results presented in the report apply only to the tested sample. Any objections to report issued by AGC should be submitted to AGC within 15days after the issuance of the test report. Further enquiry of validity or verification of the test report should be addressed to AGC by agc01@agccert.com.

Test Data of Occupied Bandwidth and -26dB Bandwidth for band 5.47-5.725 GHz-ANT 1					
Test Mode	Test Channel (MHz)	99% Occupied Bandwidth (MHz)	-26dB Bandwidth (MHz)	Limits (MHz)	Pass or Fail
802.11a	5500	16.387	22.887	N/A	Pass
	5600	16.264	18.464	N/A	Pass
	5700	16.255	18.472	N/A	Pass
802.11n20	5500	17.559	23.955	N/A	Pass
	5600	17.464	19.733	N/A	Pass
	5700	17.478	20.019	N/A	Pass
802.11n40	5510	35.943	40.839	N/A	Pass
	5590	35.899	39.282	N/A	Pass
	5670	35.918	39.755	N/A	Pass
802.11ac20	5500	18.820	20.689	N/A	Pass
	5600	18.854	20.412	N/A	Pass
	5700	18.843	20.372	N/A	Pass
802.11ac40	5510	37.555	39.821	N/A	Pass
	5590	37.531	39.767	N/A	Pass
	5670	37.572	39.796	N/A	Pass
802.11ac80	5530	76.648	80.663	N/A	Pass
	5610	76.962	80.573	N/A	Pass
802.11ax20	5500	18.852	20.738	N/A	Pass
	5600	18.856	20.430	N/A	Pass
	5700	18.827	20.654	N/A	Pass
802.11ax40	5510	37.589	39.947	N/A	Pass
	5590	37.543	39.788	N/A	Pass
	5670	37.568	39.924	N/A	Pass
802.11ac80	5530	76.885	80.685	N/A	Pass
	5610	76.938	81.648	N/A	Pass

Any report having not been signed by authorized approver, or having been altered without authorization, or having not been stamped by the "Dedicated Testing/Inspection Stamp" is deemed to be invalid. Copying or excerpting portion of, or altering the content of the report is not permitted without the written authorization of AGC. The test results presented in the report apply only to the tested sample. Any objections to report issued by AGC should be submitted to AGC within 15days after the issuance of the test report. Further enquiry of validity or verification of the test report should be addressed to AGC by agc01@agccert.com.

Test Data of Occupied Bandwidth and -26dB Bandwidth for band 5.47-5.725 GHz-ANT 2					
Test Mode	Test Channel (MHz)	99% Occupied Bandwidth (MHz)	-26dB Bandwidth (MHz)	Limits (MHz)	Pass or Fail
802.11a	5500	16.247	18.409	N/A	Pass
	5600	16.245	18.488	N/A	Pass
	5700	16.250	18.628	N/A	Pass
802.11n20	5500	17.474	19.658	N/A	Pass
	5600	17.474	19.683	N/A	Pass
	5700	17.476	19.927	N/A	Pass
802.11n40	5510	35.884	39.449	N/A	Pass
	5590	35.878	39.053	N/A	Pass
	5670	35.916	39.273	N/A	Pass
802.11ac20	5500	17.487	19.992	N/A	Pass
	5600	17.479	19.707	N/A	Pass
	5700	17.477	19.965	N/A	Pass
802.11ac40	5510	35.836	38.933	N/A	Pass
	5590	35.890	38.992	N/A	Pass
	5670	35.882	39.514	N/A	Pass
802.11ac80	5530	75.064	80.392	N/A	Pass
	5610	75.062	80.302	N/A	Pass
802.11ax20	5500	18.812	20.416	N/A	Pass
	5600	18.827	20.340	N/A	Pass
	5700	18.843	20.296	N/A	Pass
802.11ax40	5510	37.592	40.063	N/A	Pass
	5590	37.623	39.834	N/A	Pass
	5670	37.537	39.837	N/A	Pass
802.11ax80	5530	76.697	80.686	N/A	Pass
	5610	76.799	80.472	N/A	Pass

Any report having not been signed by authorized approver, or having been altered without authorization, or having not been stamped by the "Dedicated Testing/Inspection Stamp" is deemed to be invalid. Copying or excerpting portion of, or altering the content of the report is not permitted without the written authorization of AGC. The test results presented in the report apply only to the tested sample. Any objections to report issued by AGC should be submitted to AGC within 15days after the issuance of the test report. Further enquiry of validity or verification of the test report should be addressed to AGC by agc01@agccert.com.



Test Data of Occupied Bandwidth and DTS Bandwidth for band 5.725-5.85 GHz-ANT 1					
Test Mode	Test Channel (MHz)	99% Occupied Bandwidth (MHz)	DTS Bandwidth (MHz)	Limits (MHz)	Pass or Fail
802.11a	5745	16.259	15.277	0.5	Pass
	5785	16.245	13.881	0.5	Pass
	5825	16.244	15.098	0.5	Pass
802.11n20	5745	17.477	17.174	0.5	Pass
	5785	17.466	15.130	0.5	Pass
	5825	17.480	15.110	0.5	Pass
802.11n40	5755	35.923	34.055	0.5	Pass
	5795	35.902	35.024	0.5	Pass
802.11ac20	5745	17.480	15.654	0.5	Pass
	5785	17.472	15.862	0.5	Pass
	5825	17.477	17.149	0.5	Pass
802.11ac40	5755	35.911	35.416	0.5	Pass
	5795	35.887	35.022	0.5	Pass
802.11ac80	5775	75.190	69.423	0.5	Pass
802.11ax20	5180	18.823	14.223	0.5	Pass
	5200	18.825	13.736	0.5	Pass
	5240	18.809	15.227	0.5	Pass
802.11ax40	5190	37.578	35.065	0.5	Pass
	5230	37.567	35.068	0.5	Pass
802.11ax80	5210	76.845	73.868	0.5	Pass

Any report having not been signed by authorized approver, or having been altered without authorization, or having not been stamped by the "Dedicated Testing/Inspection Stamp" is deemed to be invalid. Copying or excerpting portion of, or altering the content of the report is not permitted without the written authorization of AGC. The test results presented in the report apply only to the tested sample. Any objections to report issued by AGC should be submitted to AGC within 15days after the issuance of the test report. Further enquiry of validity or verification of the test report should be addressed to AGC by agc01@agccert.com.

Test Data of Occupied Bandwidth and DTS Bandwidth for band 5.725-5.85 GHz-ANT 2					
Test Mode	Test Channel (MHz)	99% Occupied Bandwidth (MHz)	DTS Bandwidth (MHz)	Limits (MHz)	Pass or Fail
802.11a	5745	16.243	15.091	0.5	Pass
	5785	16.251	15.084	0.5	Pass
	5825	16.241	15.100	0.5	Pass
802.11n20	5745	17.475	15.687	0.5	Pass
	5785	17.487	15.664	0.5	Pass
	5825	17.464	13.881	0.5	Pass
802.11n40	5755	35.869	35.033	0.5	Pass
	5795	35.888	31.400	0.5	Pass
802.11ac20	5745	17.471	15.099	0.5	Pass
	5785	17.472	15.125	0.5	Pass
	5825	17.464	13.855	0.5	Pass
802.11ac40	5755	35.849	35.131	0.5	Pass
	5795	35.876	35.025	0.5	Pass
802.11ac80	5775	74.937	46.263	0.5	Pass
802.11ax20	5180	18.823	14.223	0.5	Pass
	5200	18.825	13.736	0.5	Pass
	5240	18.809	15.227	0.5	Pass
802.11ax40	5190	37.578	35.065	0.5	Pass
	5230	37.567	35.068	0.5	Pass
802.11ax80	5210	76.845	73.868	0.5	Pass

Any report having not been signed by authorized approver, or having been altered without authorization, or having not been stamped by the "Dedicated Testing/Inspection Stamp" is deemed to be invalid. Copying or excerpting portion of, or altering the content of the report is not permitted without the written authorization of AGC. The test results presented in the report apply only to the tested sample. Any objections to report issued by AGC should be submitted to AGC within 15days after the issuance of the test report. Further enquiry of validity or verification of the test report should be addressed to AGC by agc01@agccert.com.

**Test Graphs of Occupied Bandwidth and -26dB Bandwidth for band 5.15-5.25 GHz**

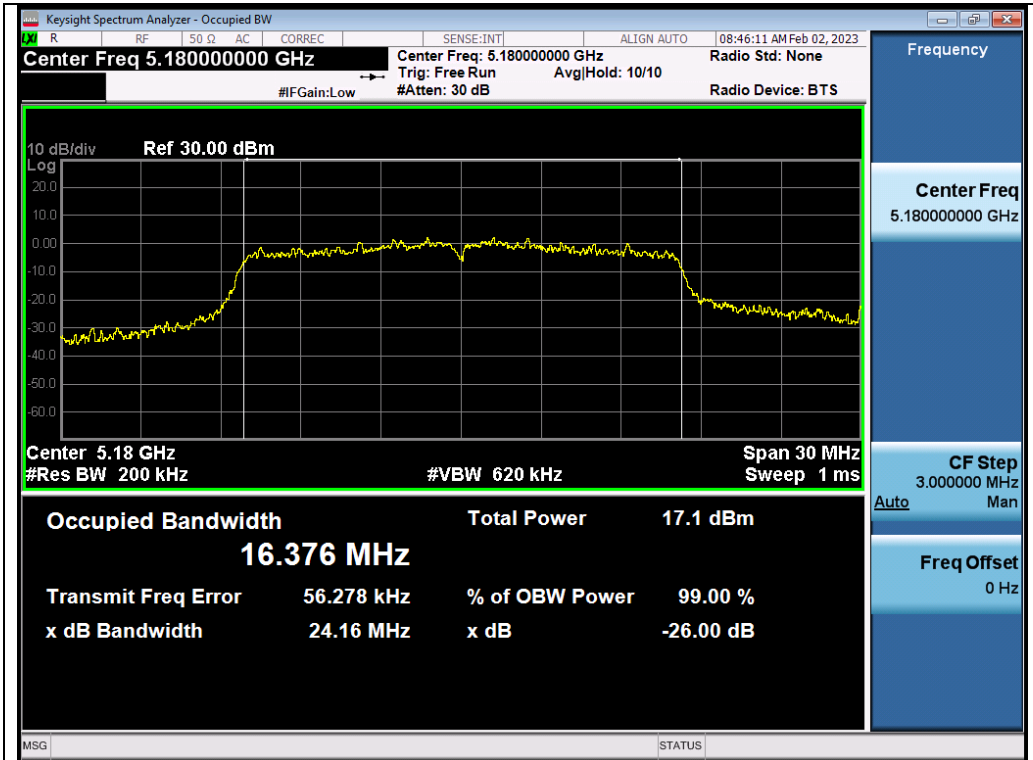

Test\_Graph\_802.11a\_ANT1\_5180\_6Mbps\_OBW

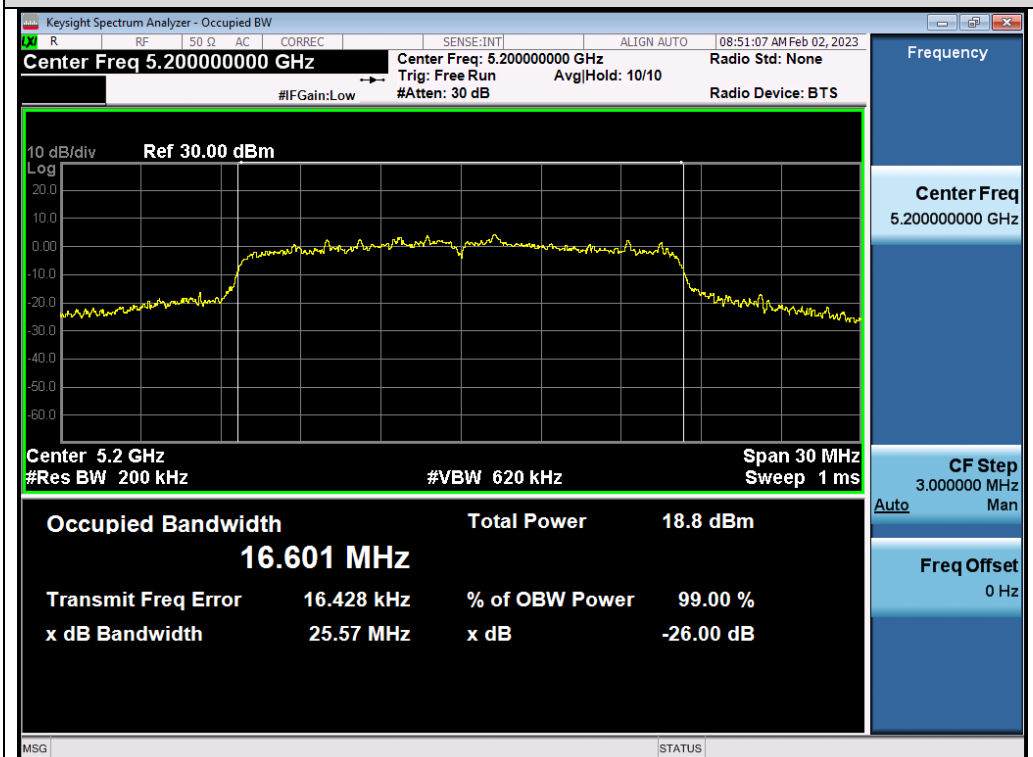

Test\_Graph\_802.11a\_ANT1\_5200\_6Mbps\_OBW

Any report having not been signed by authorized approver, or having been altered without authorization, or having not been stamped by the "Dedicated Testing/Inspection Stamp" is deemed to be invalid. Copying or excerpting portion of, or altering the content of the report is not permitted without the written authorization of AGC. The test results presented in the report apply only to the tested sample. Any objections to report issued by AGC should be submitted to AGC within 15days after the issuance of the test report. Further enquiry of validity or verification of the test report should be addressed to AGC by agc01@agccert.com.

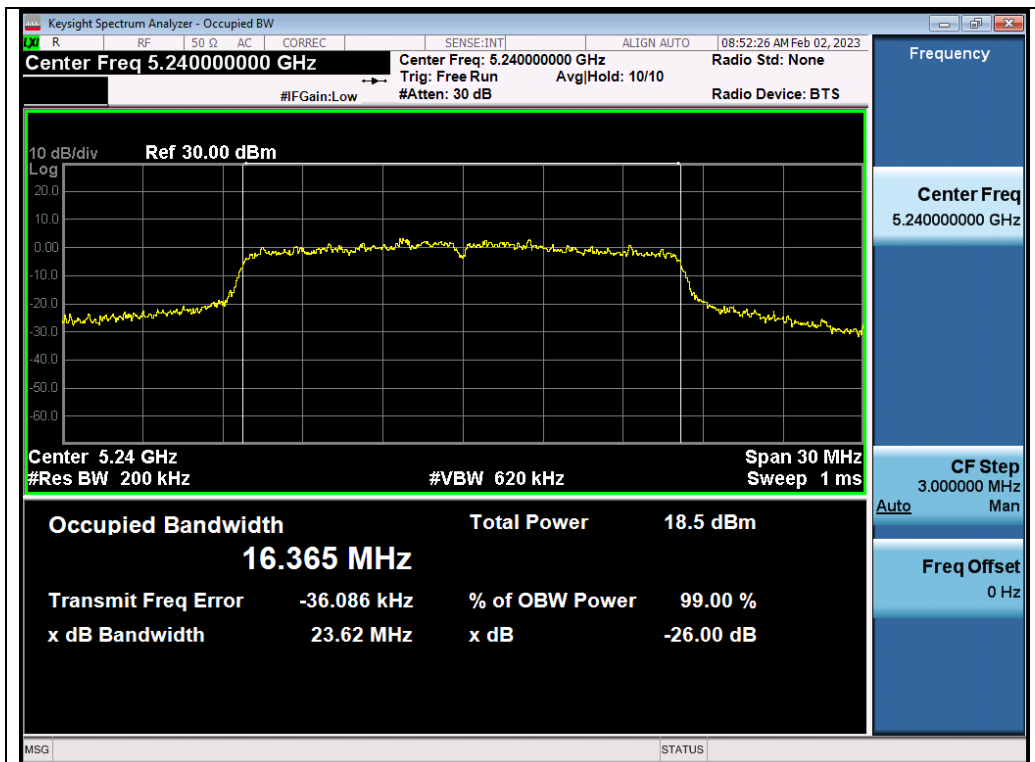

Test\_Graph\_802.11a\_ANT1\_5240\_6Mbps\_OBW

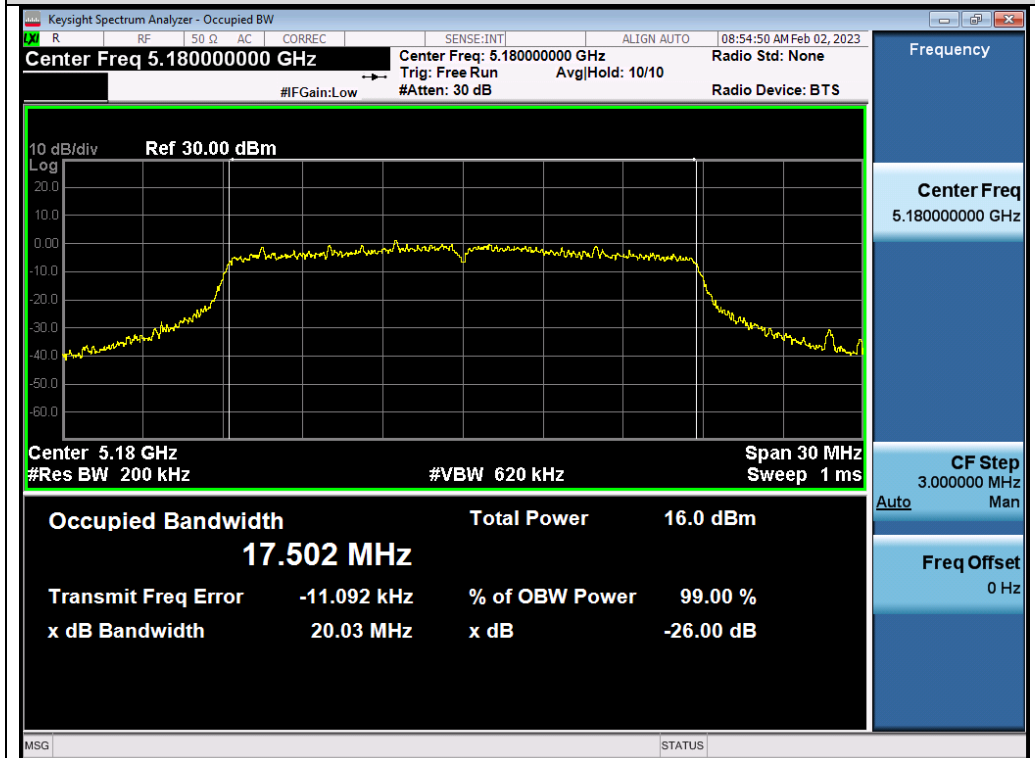

Test\_Graph\_802.11n20\_ANT1\_5180\_MCS0\_OBW

Any report having not been signed by authorized approver, or having been altered without authorization, or having not been stamped by the "Dedicated Testing/Inspection Stamp" is deemed to be invalid. Copying or excerpting portion of, or altering the content of the report is not permitted without the written authorization of AGC. The test results presented in the report apply only to the tested sample. Any objections to report issued by AGC should be submitted to AGC within 15days after the issuance of the test report. Further enquiry of validity or verification of the test report should be addressed to AGC by agc01@agccert.com.

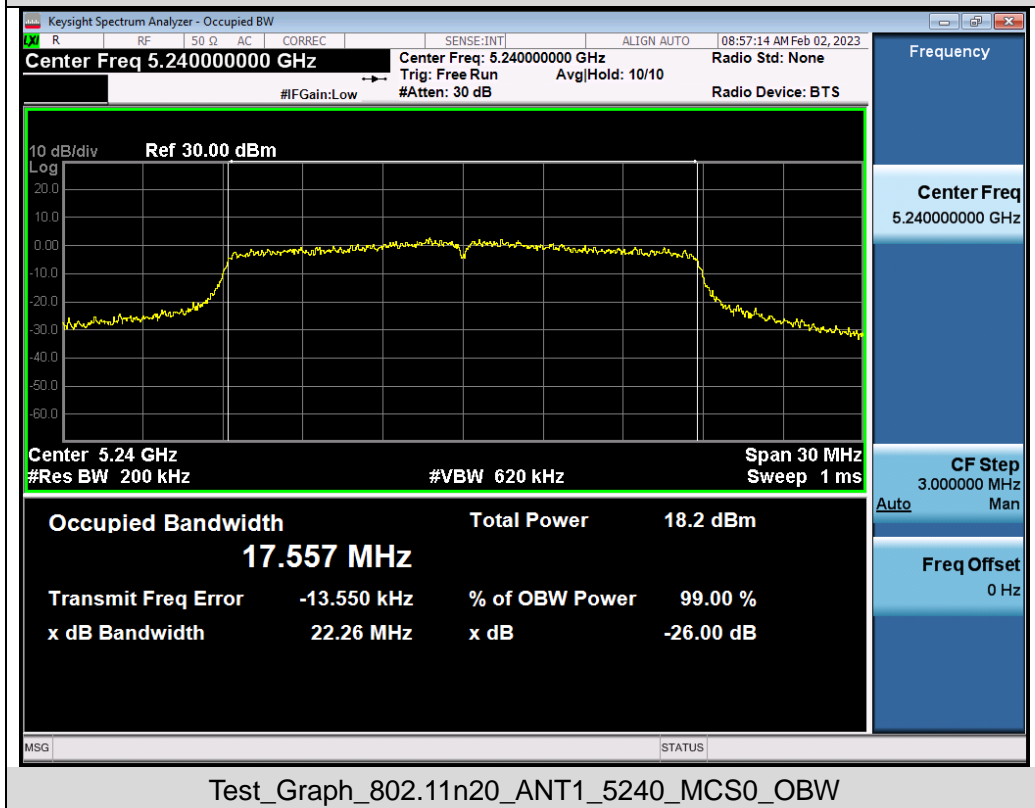
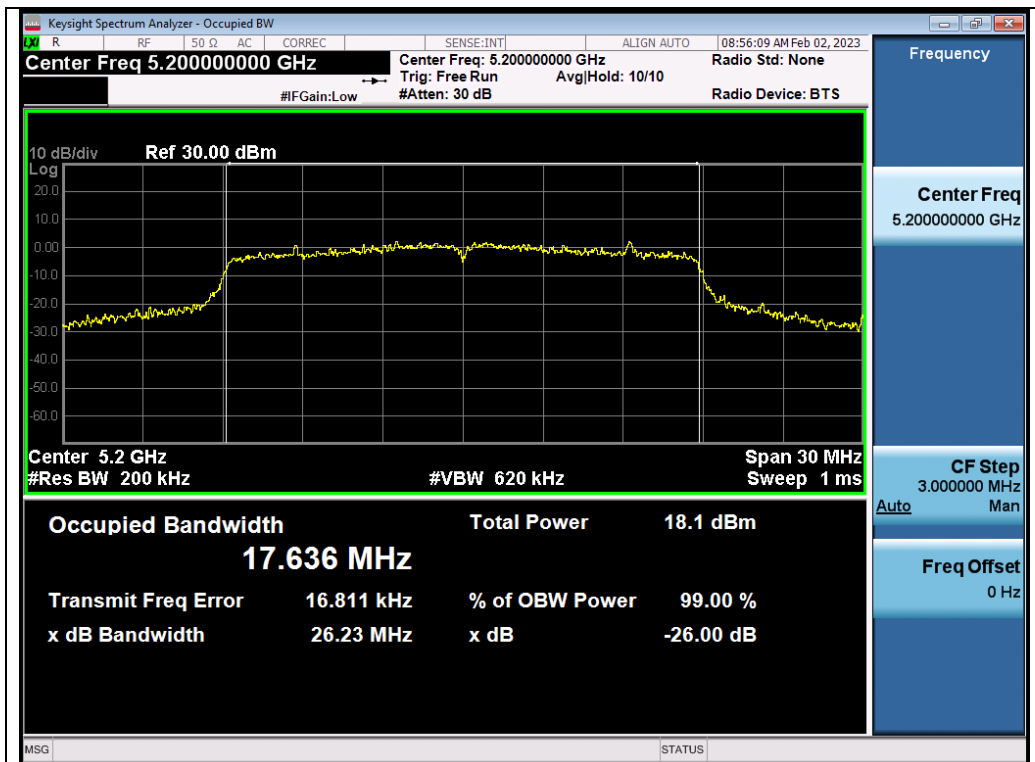

Any report having not been signed by authorized approver, or having been altered without authorization, or having not been stamped by the "Dedicated Testing/Inspection Stamp" is deemed to be invalid. Copying or excerpting portion of, or altering the content of the report is not permitted without the written authorization of AGC. The test results presented in the report apply only to the tested sample. Any objections to report issued by AGC should be submitted to AGC within 15days after the issuance of the test report. Further enquiry of validity or verification of the test report should be addressed to AGC by agc01@agccert.com.

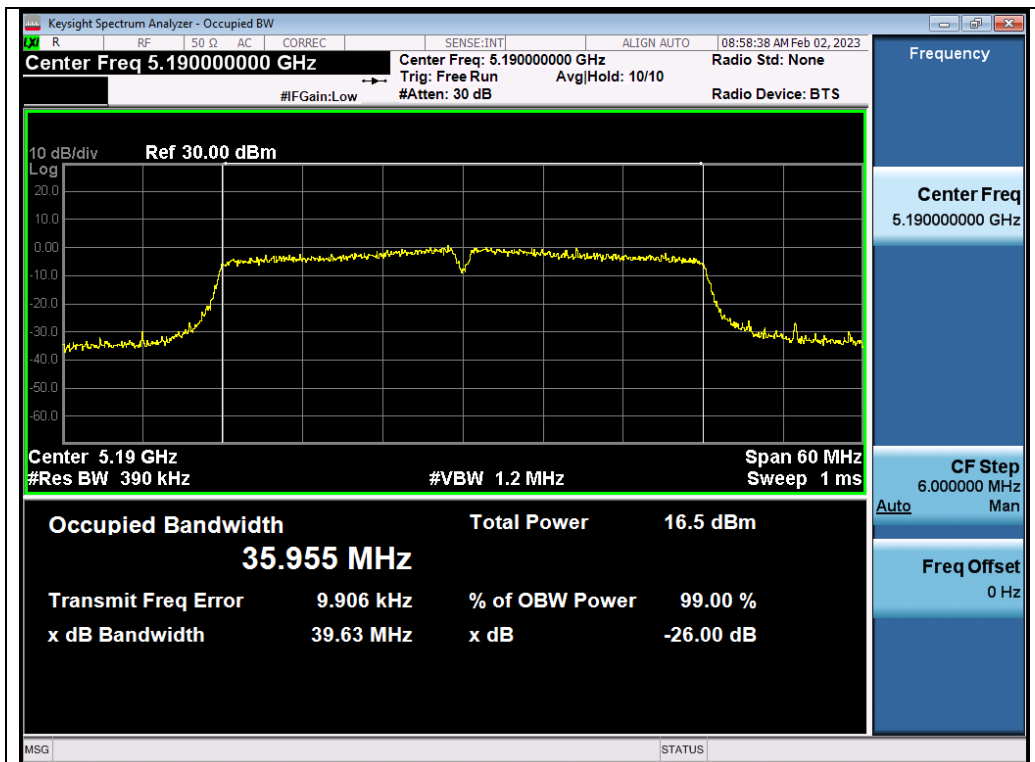

Test\_Graph\_802.11n40\_ANT1\_5190\_MCS0\_OBW

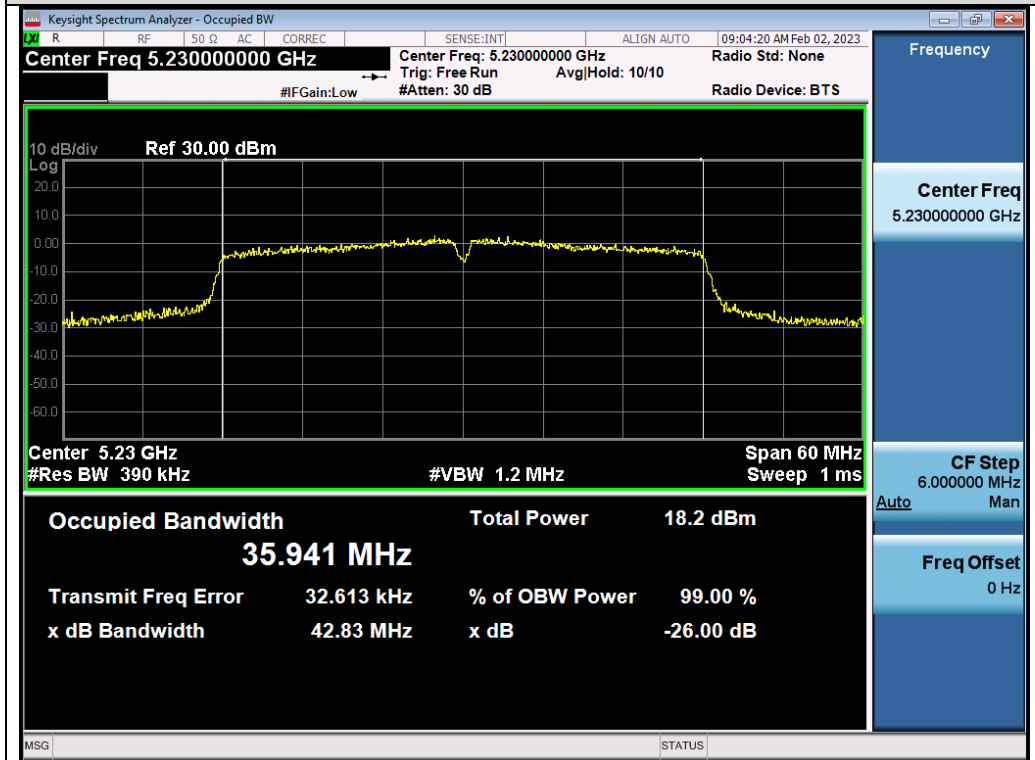

Test\_Graph\_802.11n40\_ANT1\_5230\_MCS0\_OBW

Any report having not been signed by authorized approver, or having been altered without authorization, or having not been stamped by the "Dedicated Testing/Inspection Stamp" is deemed to be invalid. Copying or excerpting portion of, or altering the content of the report is not permitted without the written authorization of AGC. The test results presented in the report apply only to the tested sample. Any objections to report issued by AGC should be submitted to AGC within 15days after the issuance of the test report. Further enquiry of validity or verification of the test report should be addressed to AGC by agc01@agccert.com.



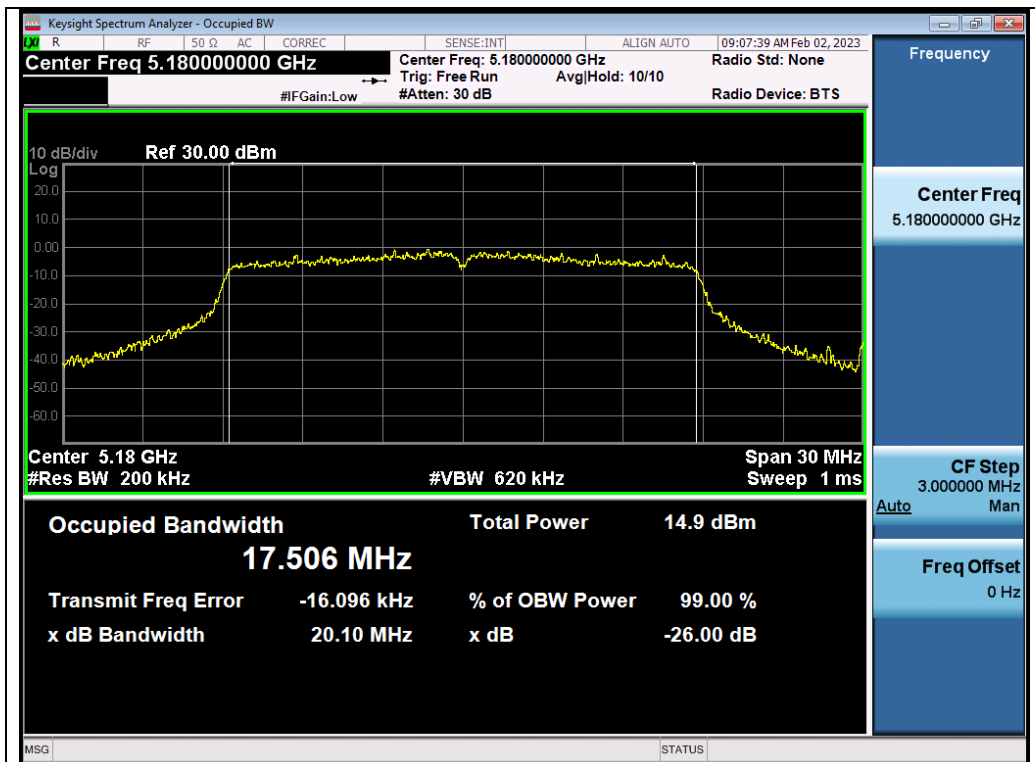

Test\_Graph\_802.11ac20\_ANT1\_5180\_MCS0\_OBW

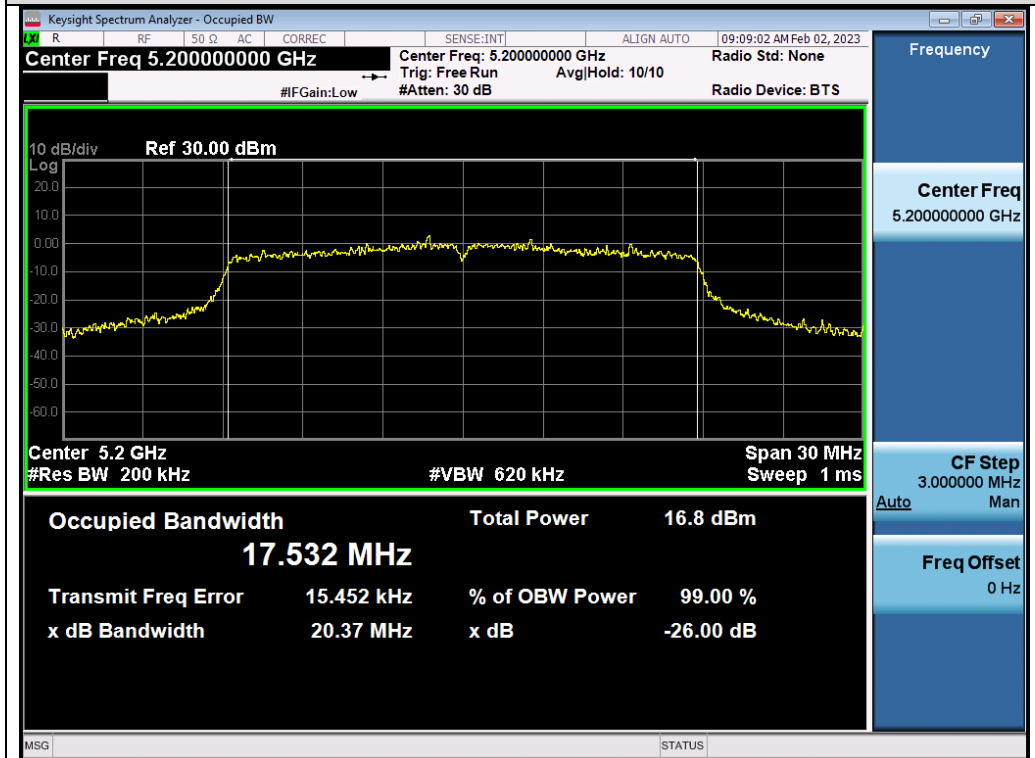

Test\_Graph\_802.11ac20\_ANT1\_5200\_MCS0\_OBW

Any report having not been signed by authorized approver, or having been altered without authorization, or having not been stamped by the "Dedicated Testing/Inspection Stamp" is deemed to be invalid. Copying or excerpting portion of, or altering the content of the report is not permitted without the written authorization of AGC. The test results presented in the report apply only to the tested sample. Any objections to report issued by AGC should be submitted to AGC within 15days after the issuance of the test report. Further enquiry of validity or verification of the test report should be addressed to AGC by agc01@agccert.com.



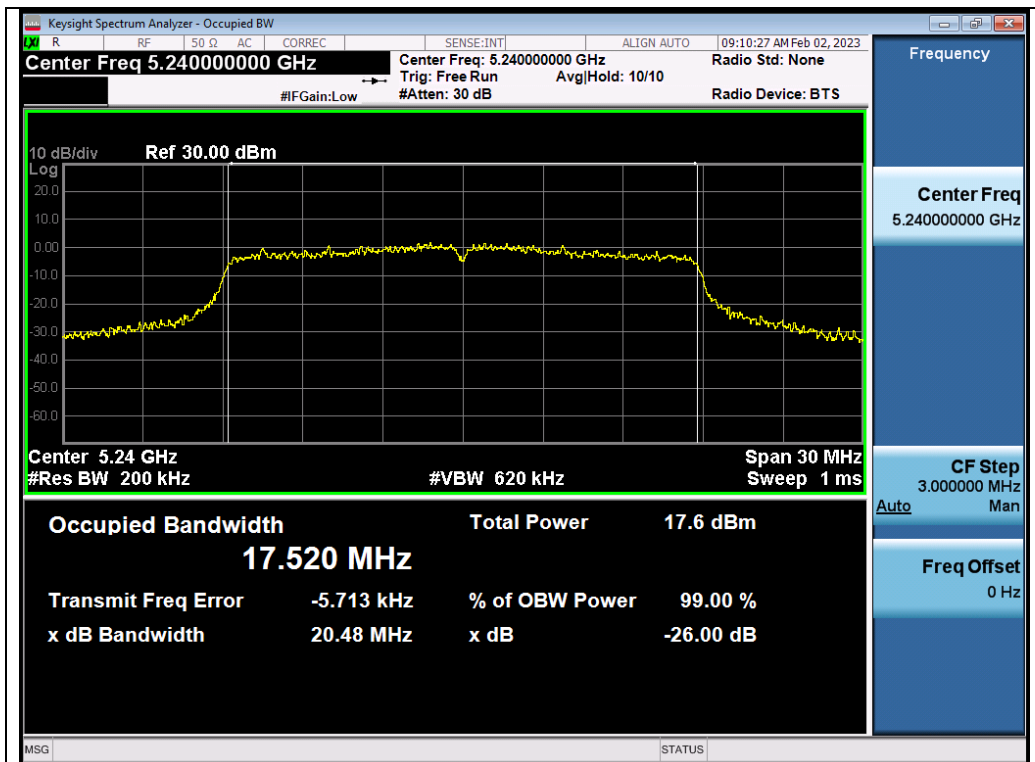

Test\_Graph\_802.11ac20\_ANT1\_5240\_MCS9\_OBW

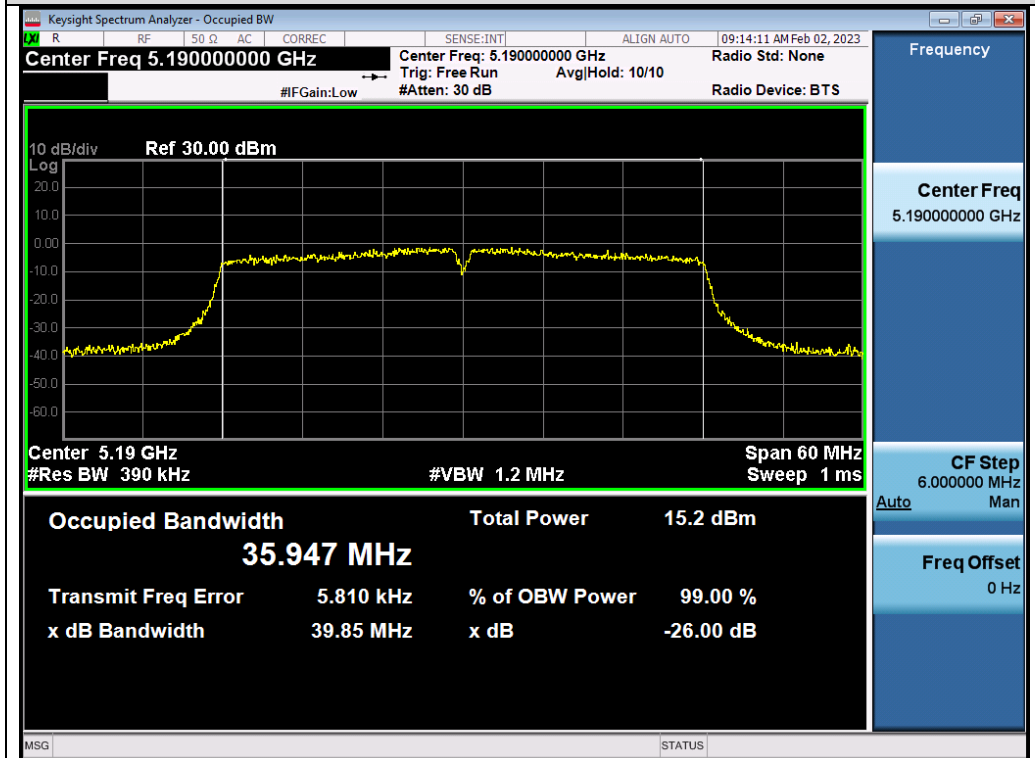

Test\_Graph\_802.11ac40\_ANT1\_5190\_MCS9\_OBW

Any report having not been signed by authorized approver, or having been altered without authorization, or having not been stamped by the "Dedicated Testing/Inspection Stamp" is deemed to be invalid. Copying or excerpting portion of, or altering the content of the report is not permitted without the written authorization of AGC. The test results presented in the report apply only to the tested sample. Any objections to report issued by AGC should be submitted to AGC within 15days after the issuance of the test report. Further enquiry of validity or verification of the test report should be addressed to AGC by agc01@agccert.com.

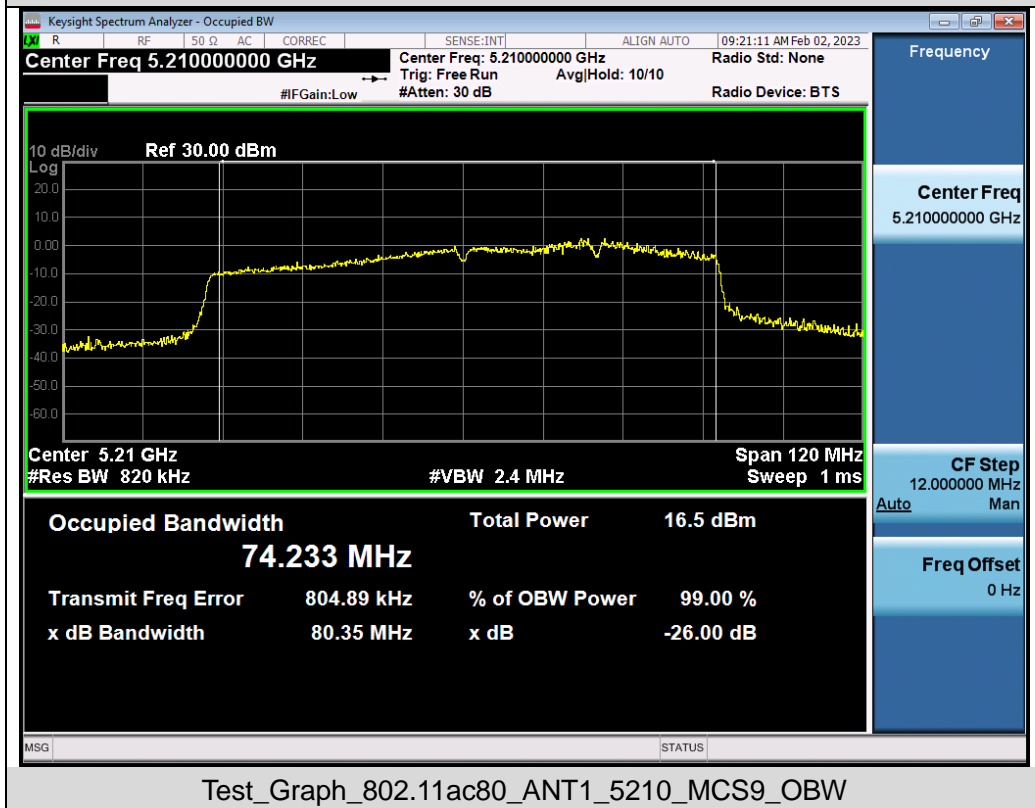
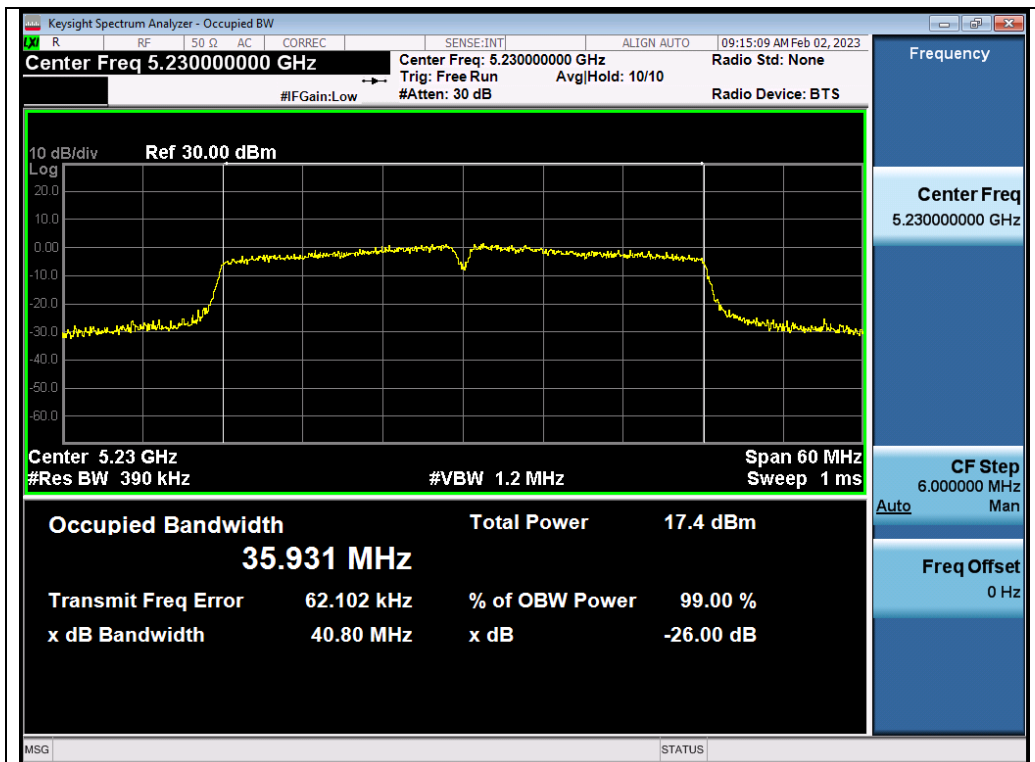

Any report having not been signed by authorized approver, or having been altered without authorization, or having not been stamped by the "Dedicated Testing/Inspection Stamp" is deemed to be invalid. Copying or excerpting portion of, or altering the content of the report is not permitted without the written authorization of AGC. The test results presented in the report apply only to the tested sample. Any objections to report issued by AGC should be submitted to AGC within 15days after the issuance of the test report. Further enquiry of validity or verification of the test report should be addressed to AGC by agc01@agccert.com.

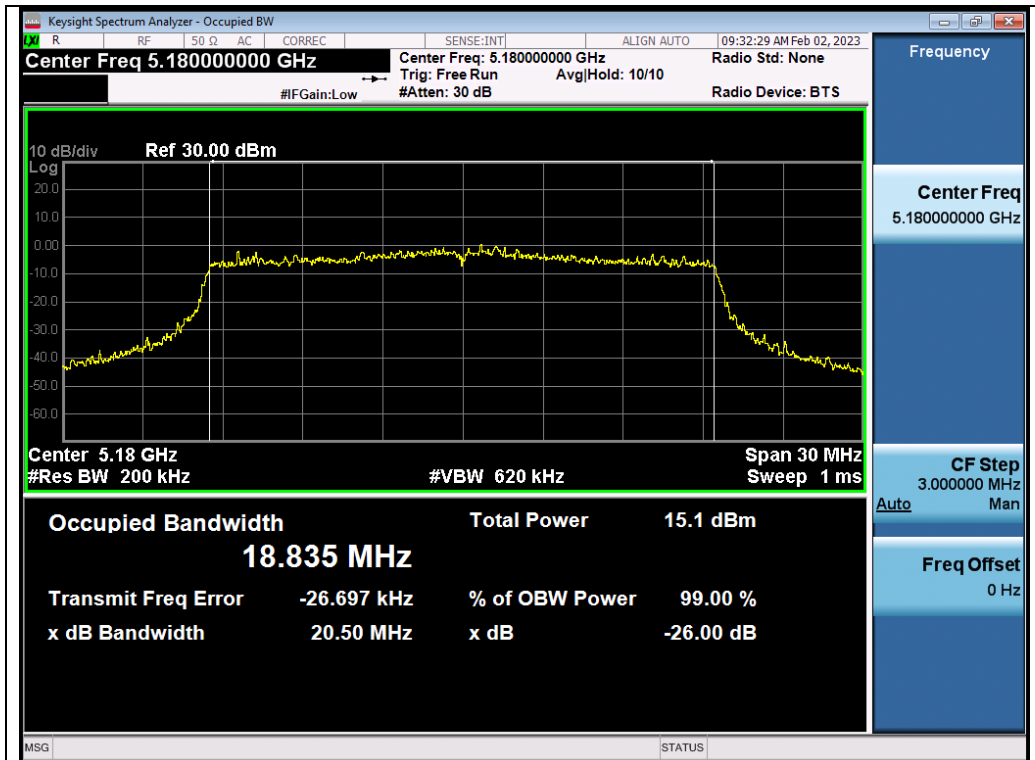

Test\_Graph\_802.11ax20\_ANT1\_5180\_MCS0\_OBW

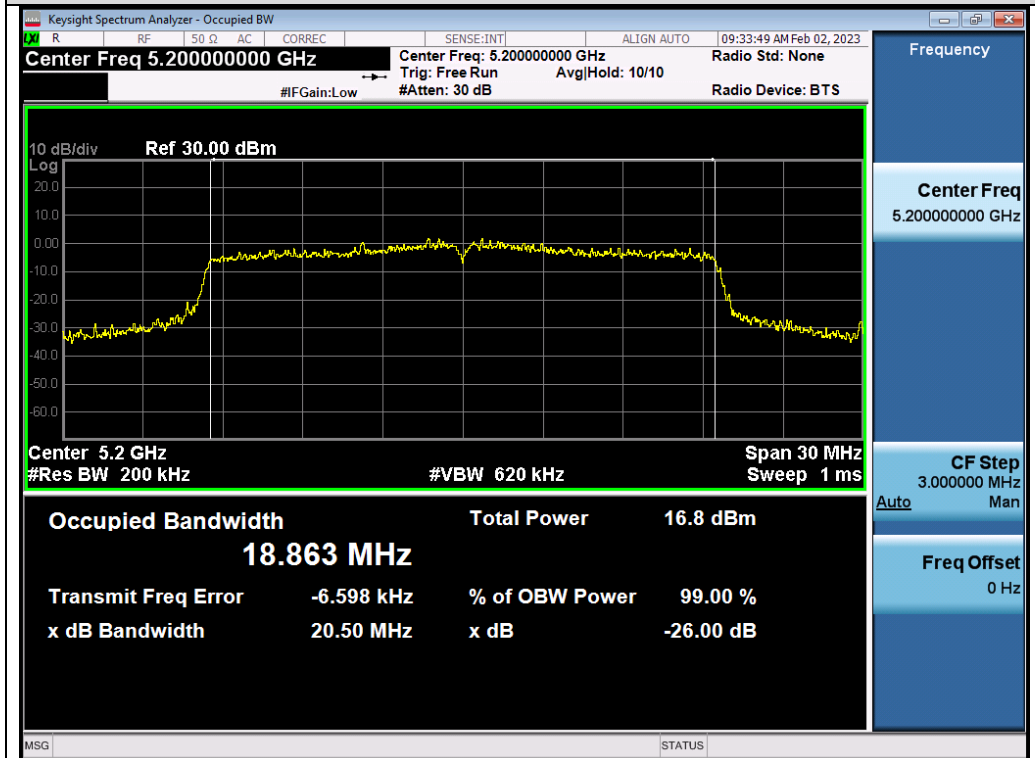

Test\_Graph\_802.11ax20\_ANT1\_5200\_MCS0\_OBW

Any report having not been signed by authorized approver, or having been altered without authorization, or having not been stamped by the "Dedicated Testing/Inspection Stamp" is deemed to be invalid. Copying or excerpting portion of, or altering the content of the report is not permitted without the written authorization of AGC. The test results presented in the report apply only to the tested sample. Any objections to report issued by AGC should be submitted to AGC within 15days after the issuance of the test report. Further enquiry of validity or verification of the test report should be addressed to AGC by agc01@agccert.com.

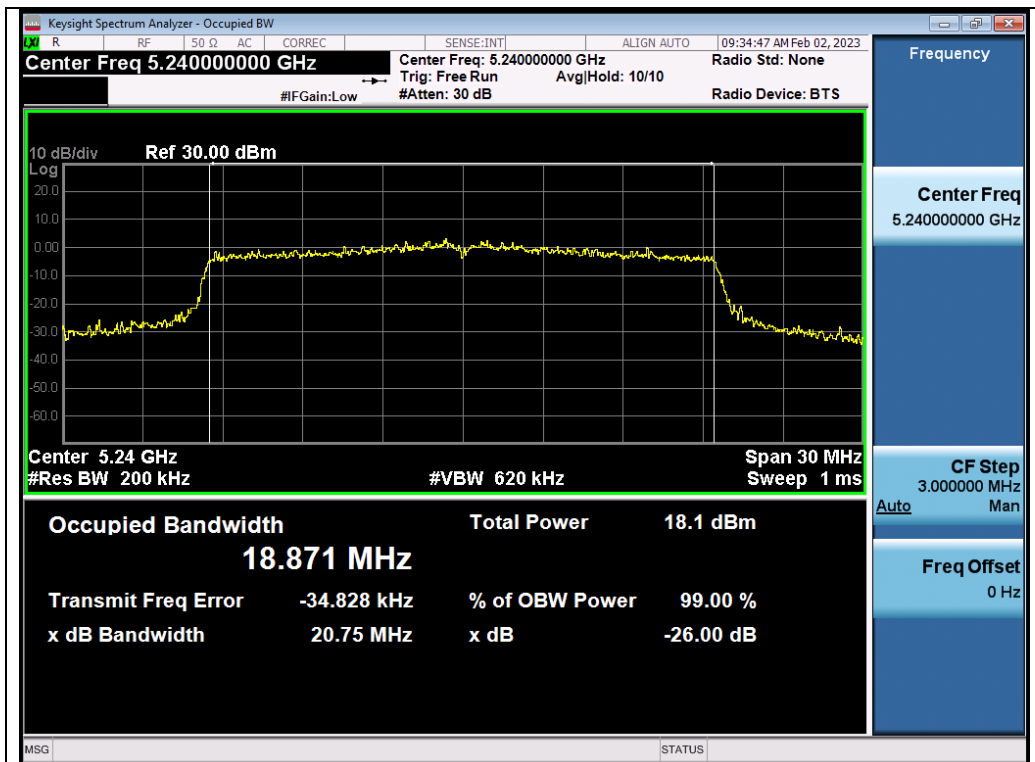

Test\_Graph\_802.11ax20\_ANT1\_5240\_MCS0\_OBW

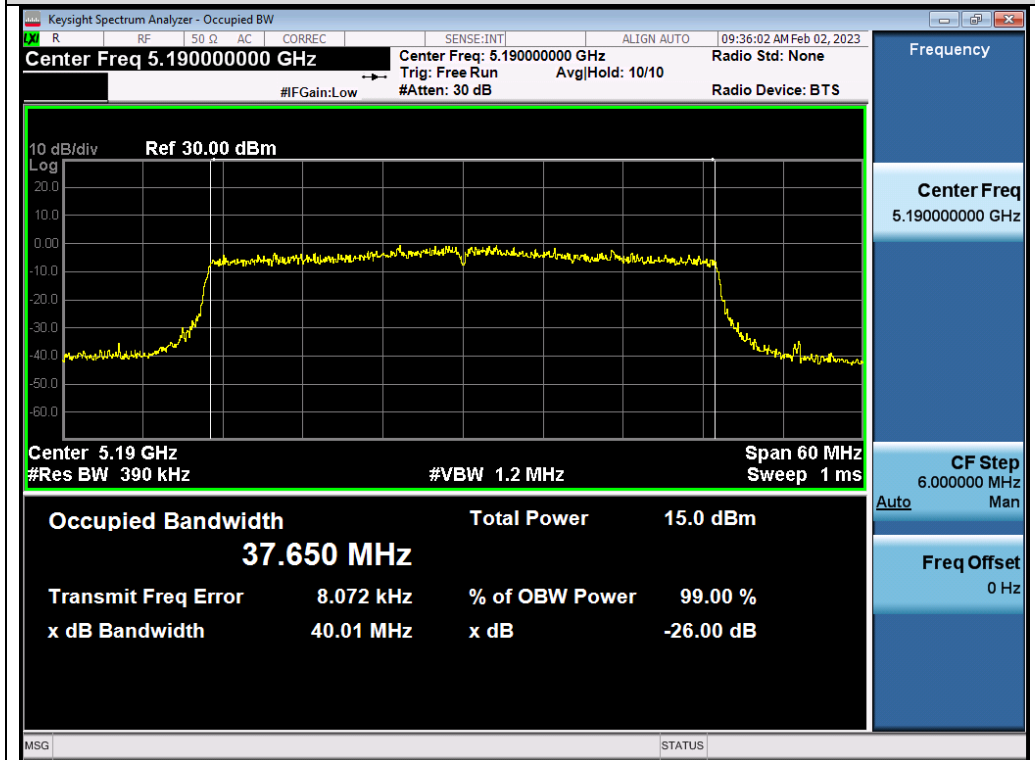

Test\_Graph\_802.11ax40\_ANT1\_5190\_MCS0\_OBW

Any report having not been signed by authorized approver, or having been altered without authorization, or having not been stamped by the "Dedicated Testing/Inspection Stamp" is deemed to be invalid. Copying or excerpting portion of, or altering the content of the report is not permitted without the written authorization of AGC. The test results presented in the report apply only to the tested sample. Any objections to report issued by AGC should be submitted to AGC within 15days after the issuance of the test report. Further enquiry of validity or verification of the test report should be addressed to AGC by agc01@agccert.com.

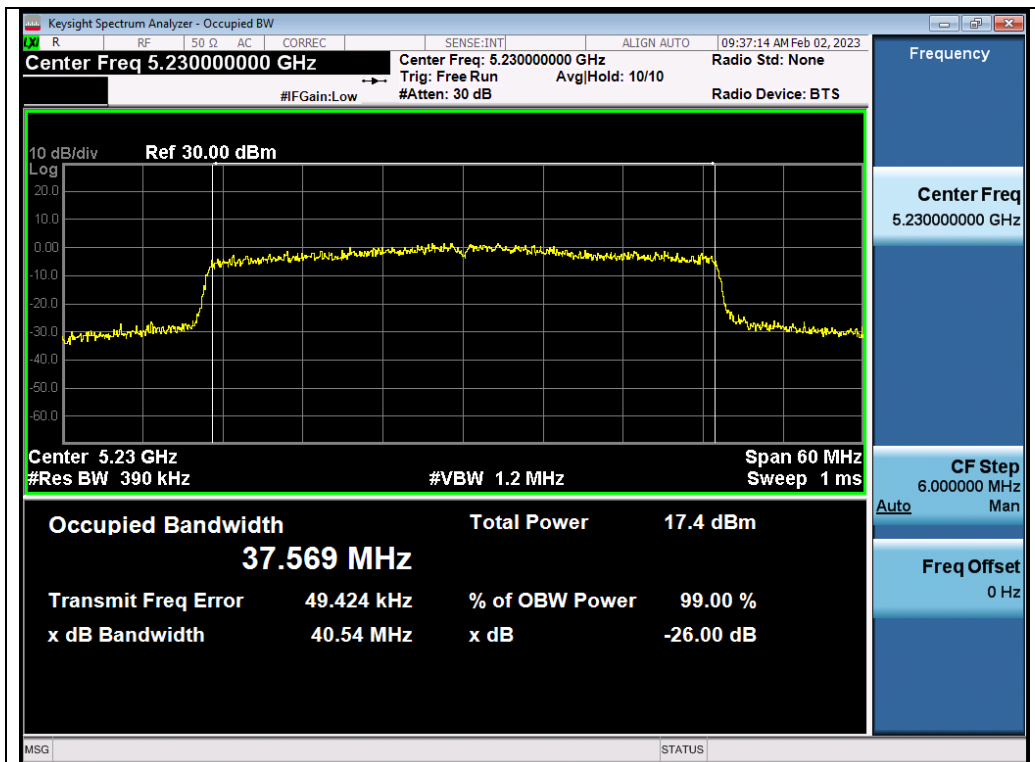

Test\_Graph\_802.11ax40\_ANT1\_5230\_MCS0\_OBW

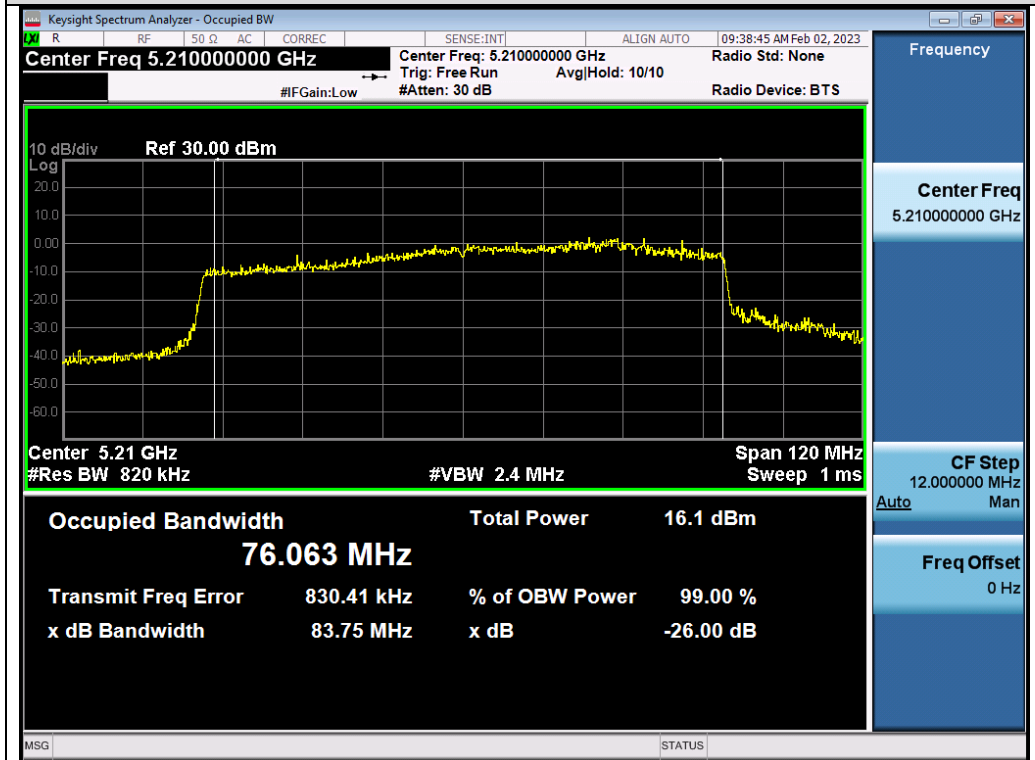

Test\_Graph\_802.11ax80\_ANT1\_5210\_MCS0\_OBW

Any report having not been signed by authorized approver, or having been altered without authorization, or having not been stamped by the "Dedicated Testing/Inspection Stamp" is deemed to be invalid. Copying or excerpting portion of, or altering the content of the report is not permitted without the written authorization of AGC. The test results presented in the report apply only to the tested sample. Any objections to report issued by AGC should be submitted to AGC within 15days after the issuance of the test report. Further enquiry of validity or verification of the test report should be addressed to AGC by agc01@agccert.com.



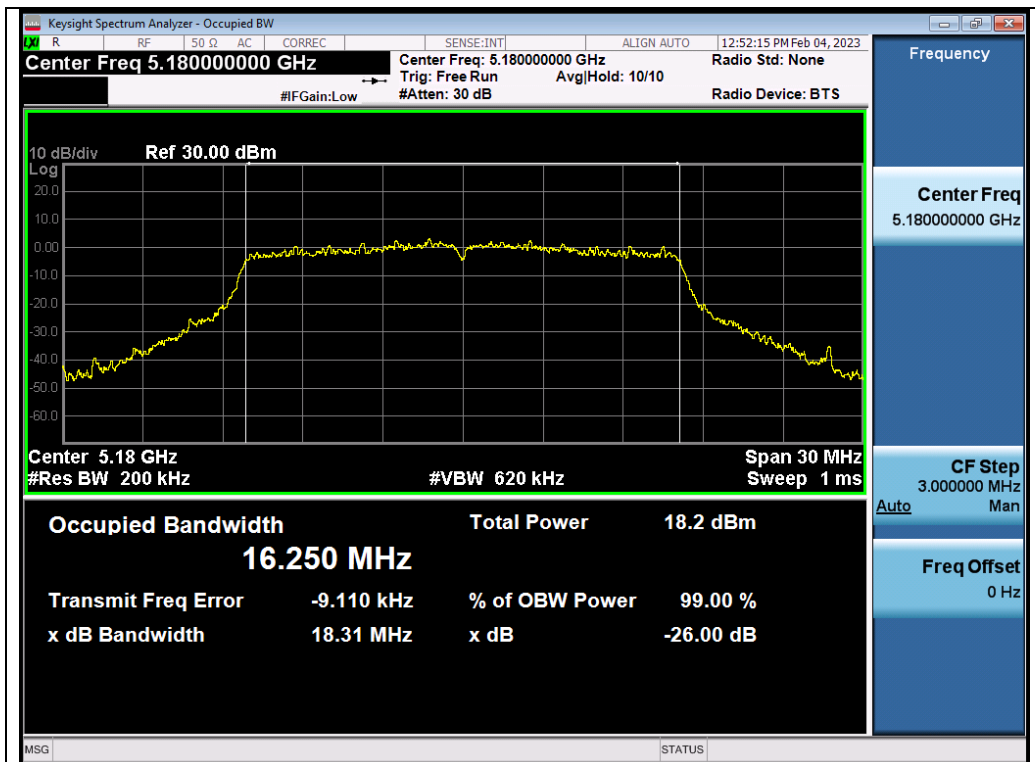

Test\_Graph\_802.11a\_ANT2\_5180\_6Mbps\_OBW

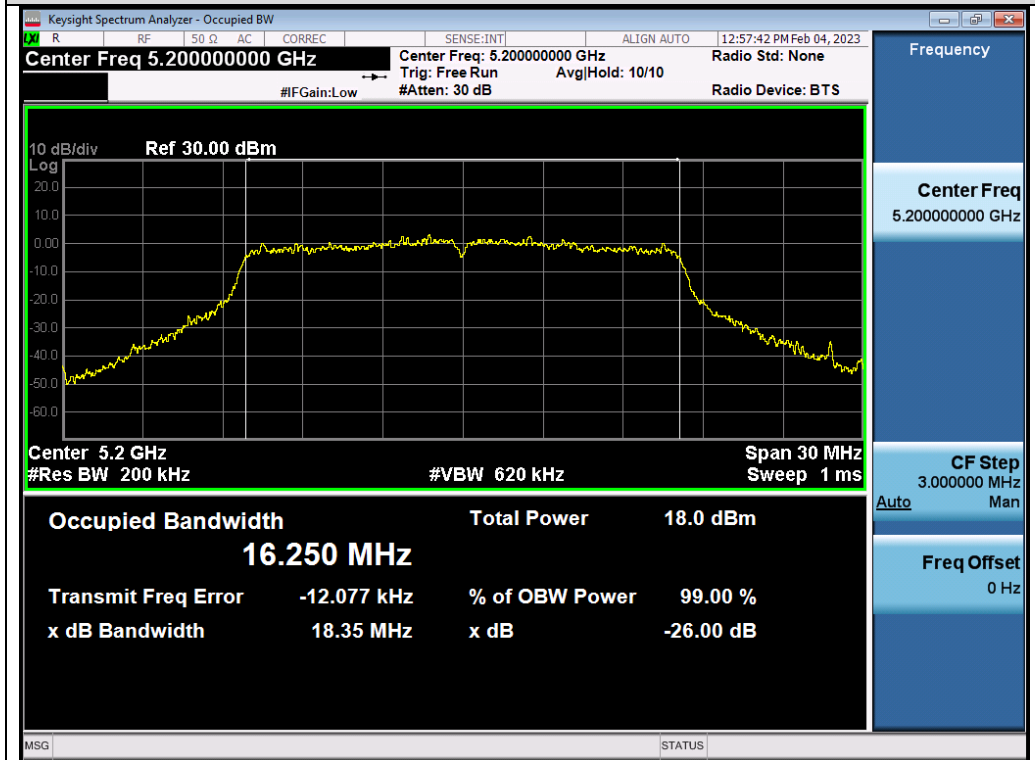

Test\_Graph\_802.11a\_ANT2\_5200\_6Mbps\_OBW

Any report having not been signed by authorized approver, or having been altered without authorization, or having not been stamped by the "Dedicated Testing/Inspection Stamp" is deemed to be invalid. Copying or excerpting portion of, or altering the content of the report is not permitted without the written authorization of AGC. The test results presented in the report apply only to the tested sample. Any objections to report issued by AGC should be submitted to AGC within 15days after the issuance of the test report. Further enquiry of validity or verification of the test report should be addressed to AGC by agc01@agccert.com.

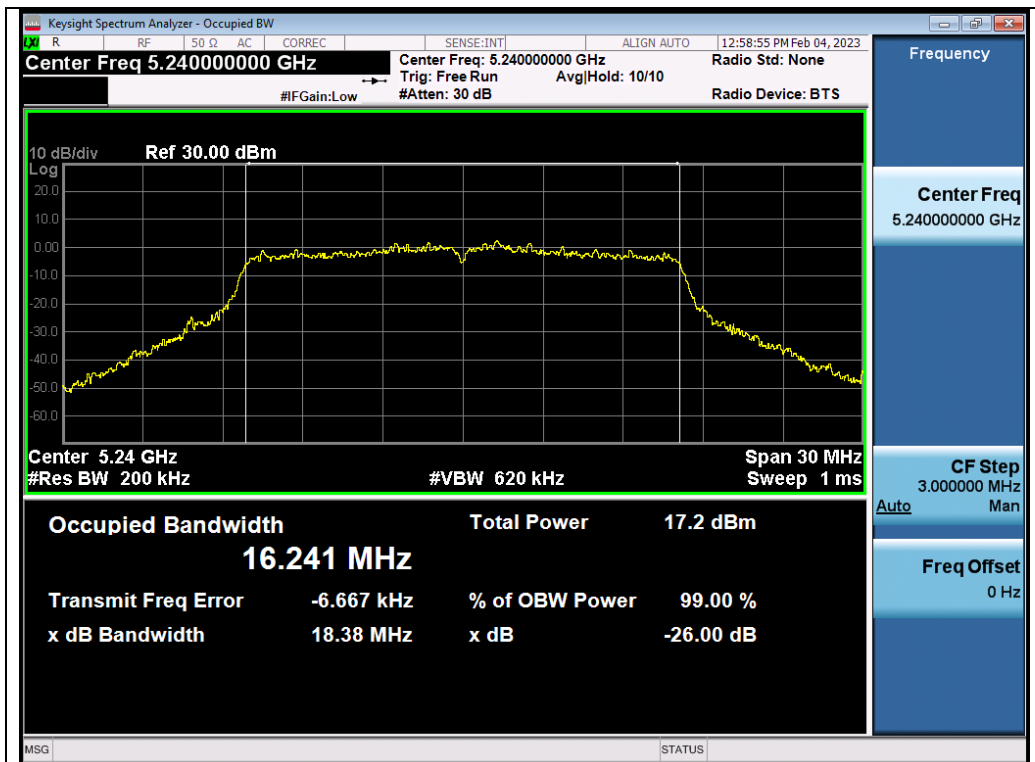

Test\_Graph\_802.11a\_ANT2\_5240\_6Mbps\_OBW

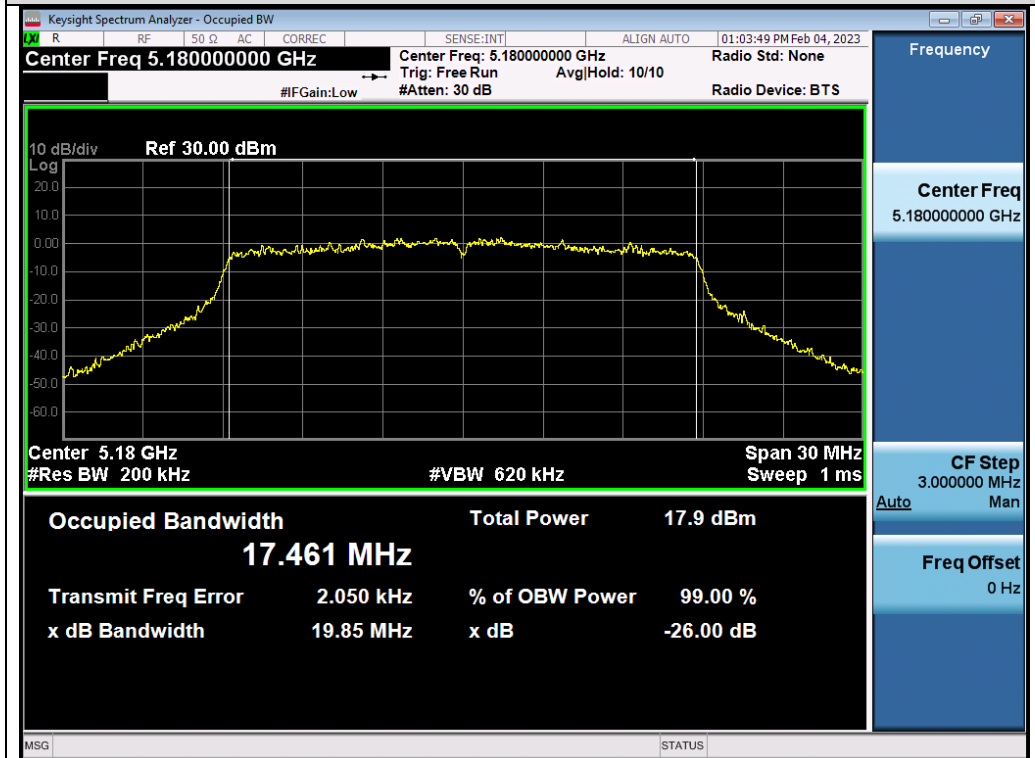

Test\_Graph\_802.11n20\_ANT2\_5180\_MCS0\_OBW

Any report having not been signed by authorized approver, or having been altered without authorization, or having not been stamped by the "Dedicated Testing/Inspection Stamp" is deemed to be invalid. Copying or excerpting portion of, or altering the content of the report is not permitted without the written authorization of AGC. The test results presented in the report apply only to the tested sample. Any objections to report issued by AGC should be submitted to AGC within 15days after the issuance of the test report. Further enquiry of validity or verification of the test report should be addressed to AGC by agc01@agccert.com.



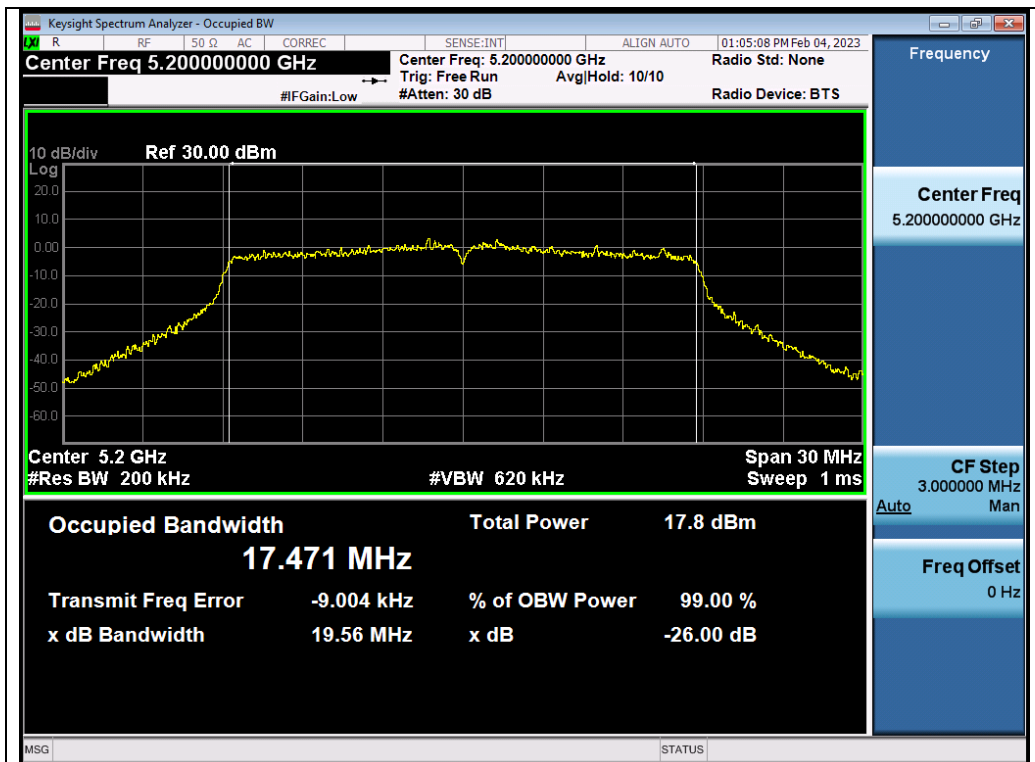

Test\_Graph\_802.11n20\_ANT2\_5200\_MCS0\_OBW

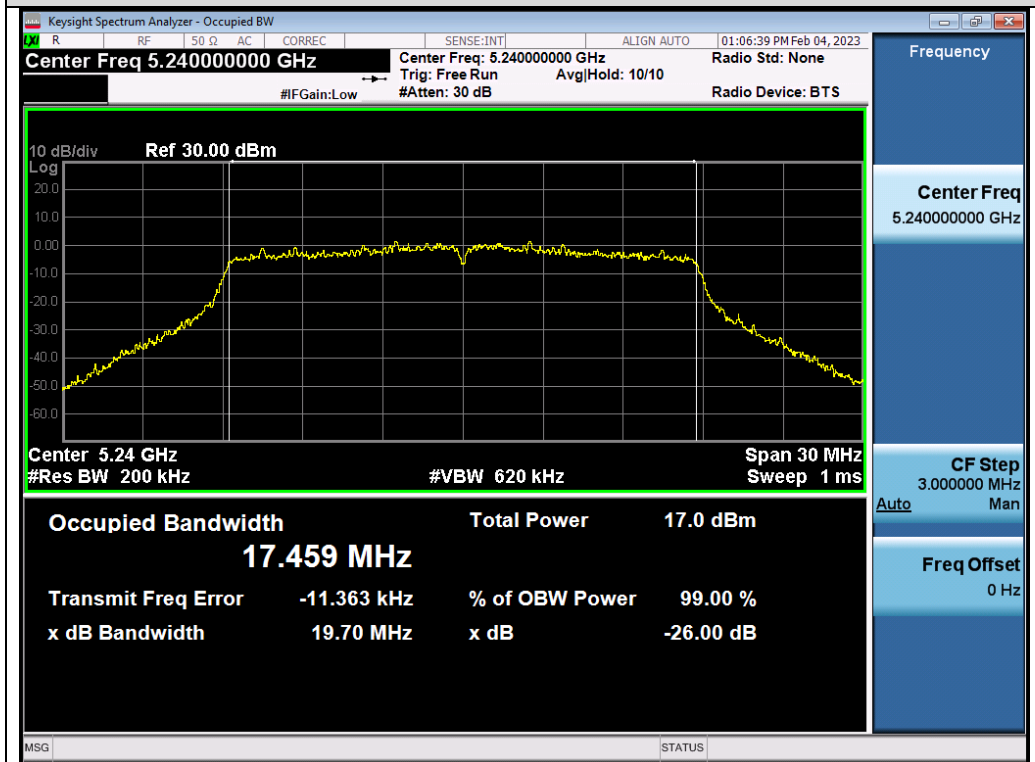

Test\_Graph\_802.11n20\_ANT2\_5240\_MCS0\_OBW

Any report having not been signed by authorized approver, or having been altered without authorization, or having not been stamped by the "Dedicated Testing/Inspection Stamp" is deemed to be invalid. Copying or excerpting portion of, or altering the content of the report is not permitted without the written authorization of AGC. The test results presented in the report apply only to the tested sample. Any objections to report issued by AGC should be submitted to AGC within 15days after the issuance of the test report. Further enquiry of validity or verification of the test report should be addressed to AGC by agc01@agccert.com.

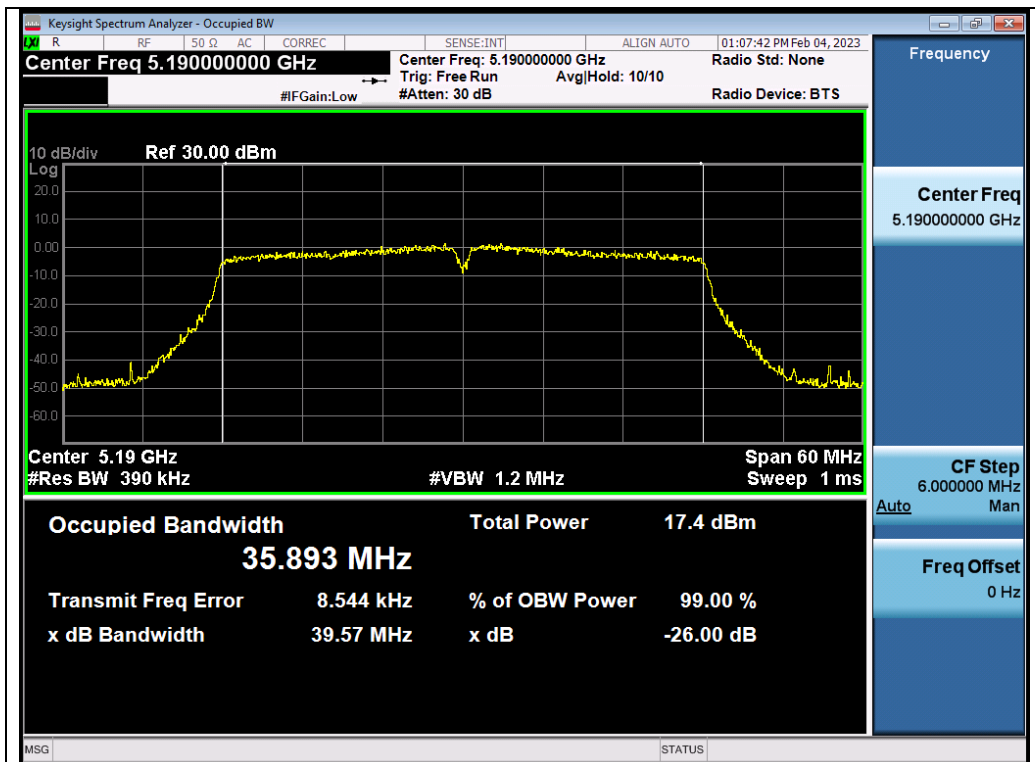

Test\_Graph\_802.11n40\_ANT2\_5190\_MCS0\_OBW

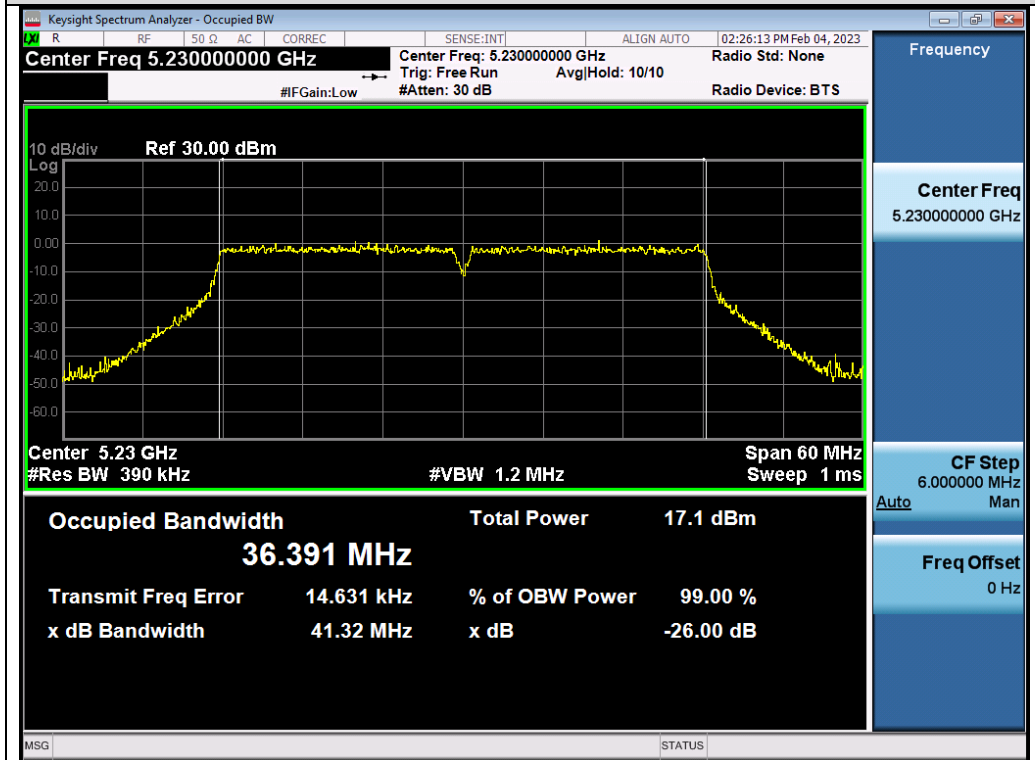

Test\_Graph\_802.11n40\_ANT2\_5230\_MCS0\_OBW

Any report having not been signed by authorized approver, or having been altered without authorization, or having not been stamped by the "Dedicated Testing/Inspection Stamp" is deemed to be invalid. Copying or excerpting portion of, or altering the content of the report is not permitted without the written authorization of AGC. The test results presented in the report apply only to the tested sample. Any objections to report issued by AGC should be submitted to AGC within 15days after the issuance of the test report. Further enquiry of validity or verification of the test report should be addressed to AGC by agc01@agccert.com.

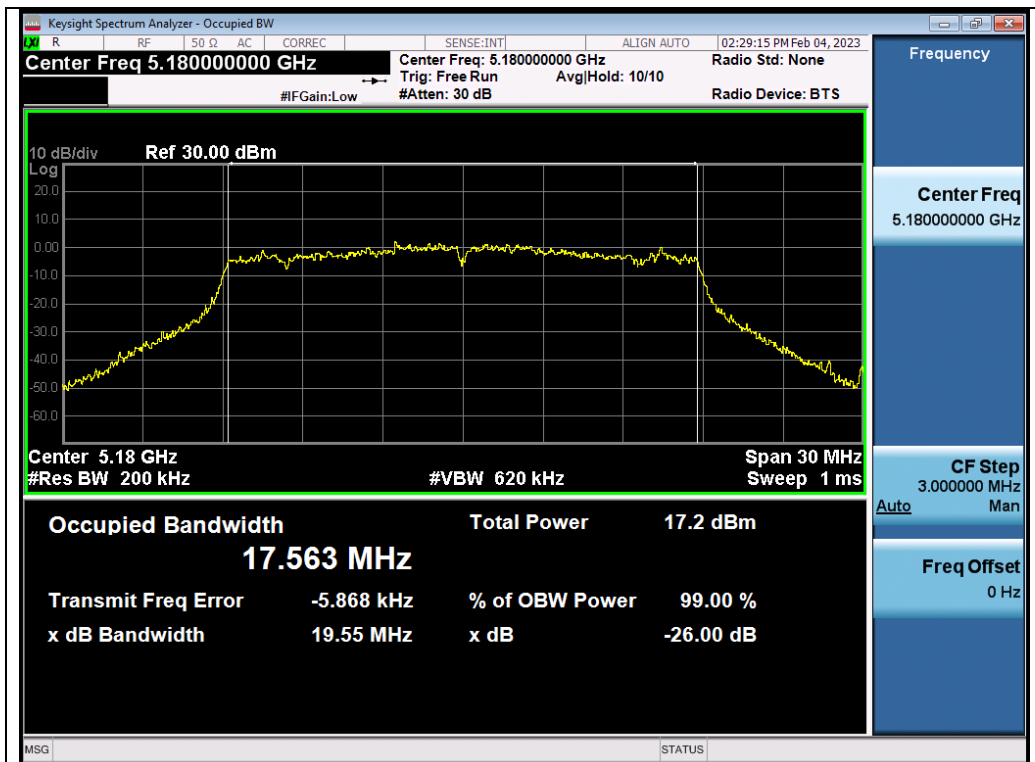

Test\_Graph\_802.11ac20\_ANT2\_5180\_MCS0\_OBW

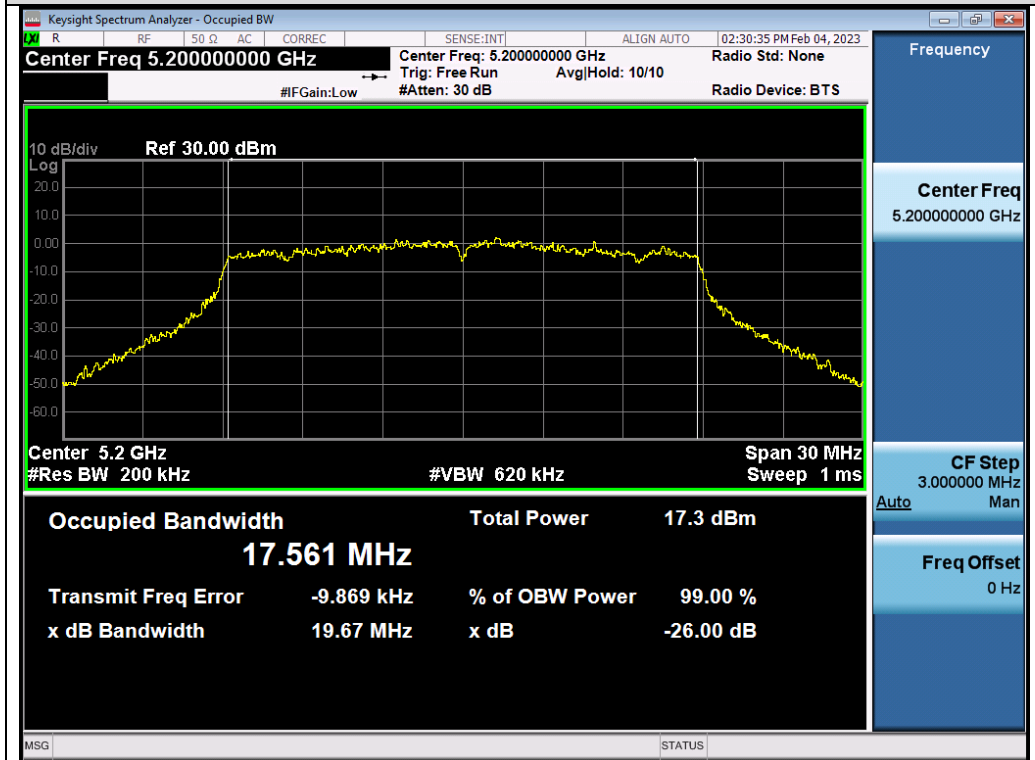

Test\_Graph\_802.11ac20\_ANT2\_5200\_MCS0\_OBW

Any report having not been signed by authorized approver, or having been altered without authorization, or having not been stamped by the "Dedicated Testing/Inspection Stamp" is deemed to be invalid. Copying or excerpting portion of, or altering the content of the report is not permitted without the written authorization of AGC. The test results presented in the report apply only to the tested sample. Any objections to report issued by AGC should be submitted to AGC within 15days after the issuance of the test report. Further enquiry of validity or verification of the test report should be addressed to AGC by agc01@agccert.com.

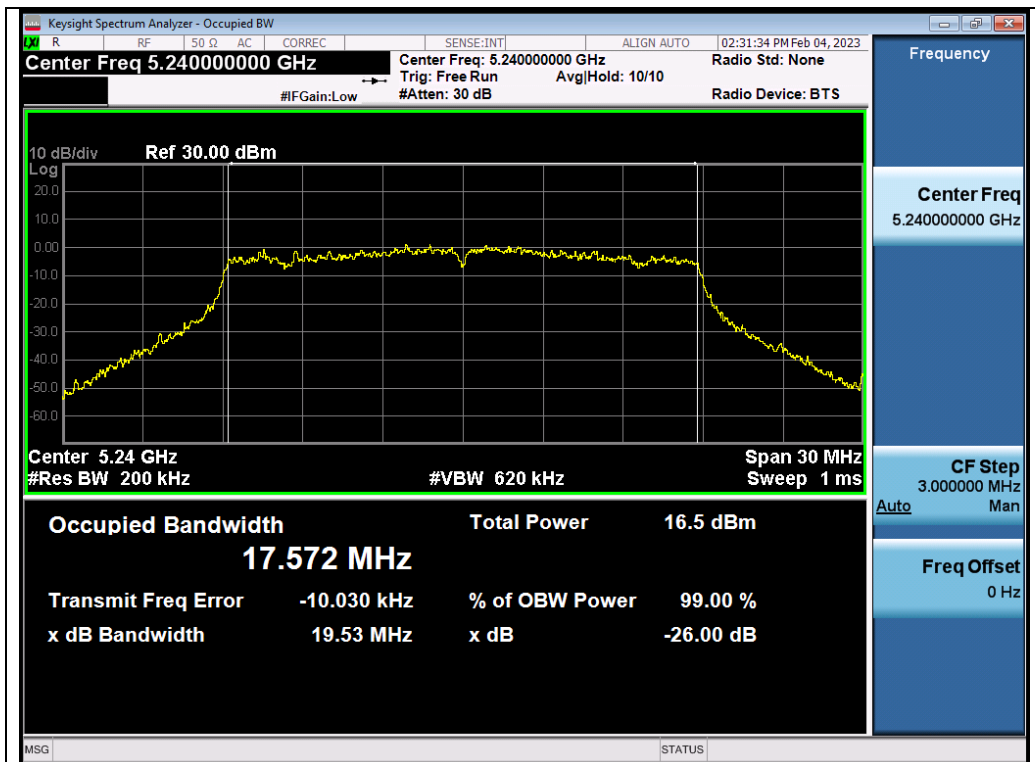

Test\_Graph\_802.11ac20\_ANT2\_5240\_MCS9\_OBW

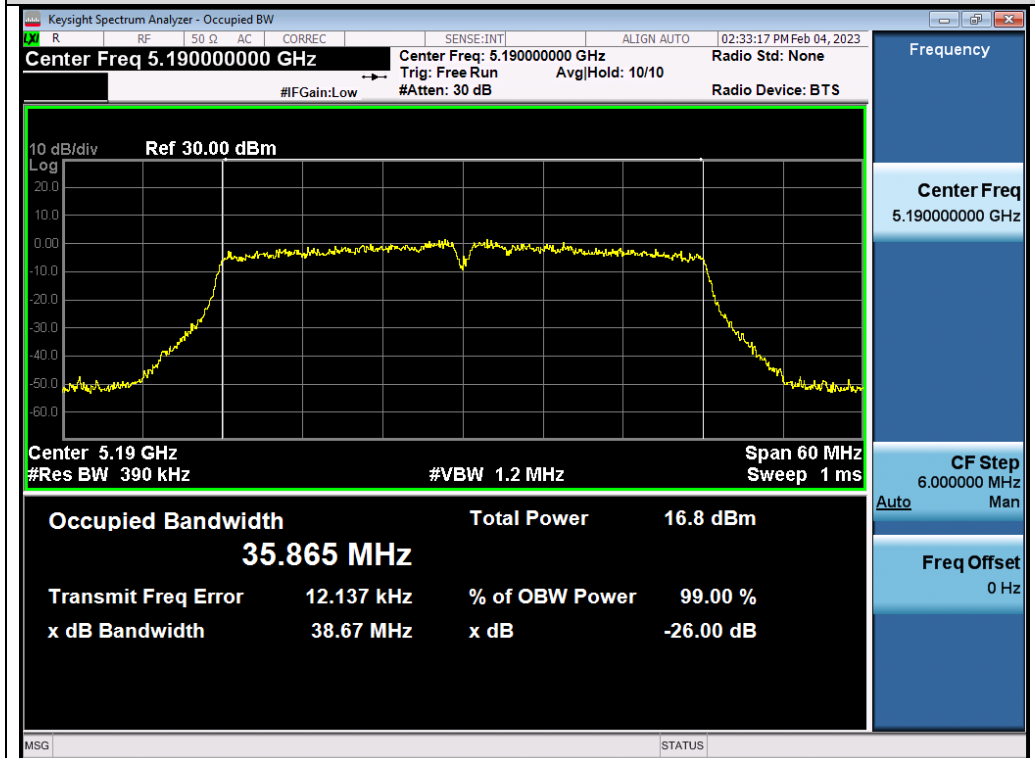

Test\_Graph\_802.11ac40\_ANT2\_5190\_MCS9\_OBW

Any report having not been signed by authorized approver, or having been altered without authorization, or having not been stamped by the "Dedicated Testing/Inspection Stamp" is deemed to be invalid. Copying or excerpting portion of, or altering the content of the report is not permitted without the written authorization of AGC. The test results presented in the report apply only to the tested sample. Any objections to report issued by AGC should be submitted to AGC within 15days after the issuance of the test report. Further enquiry of validity or verification of the test report should be addressed to AGC by agc01@agccert.com.

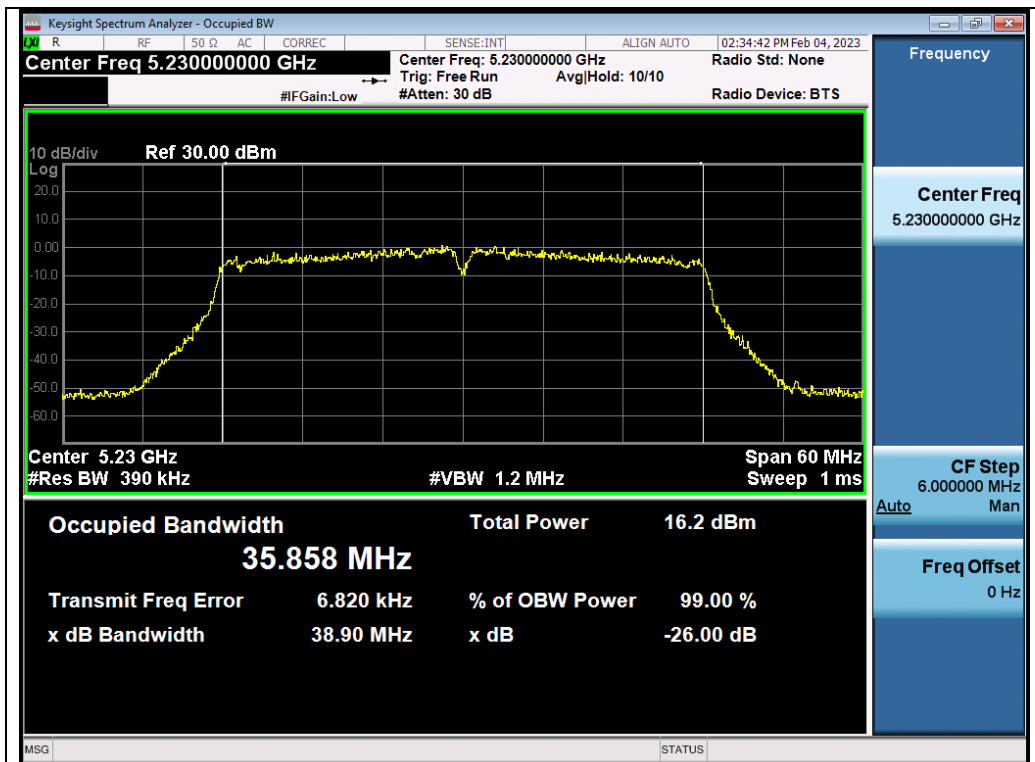

Test\_Graph\_802.11ac40\_ANT2\_5230\_MCS9\_OBW

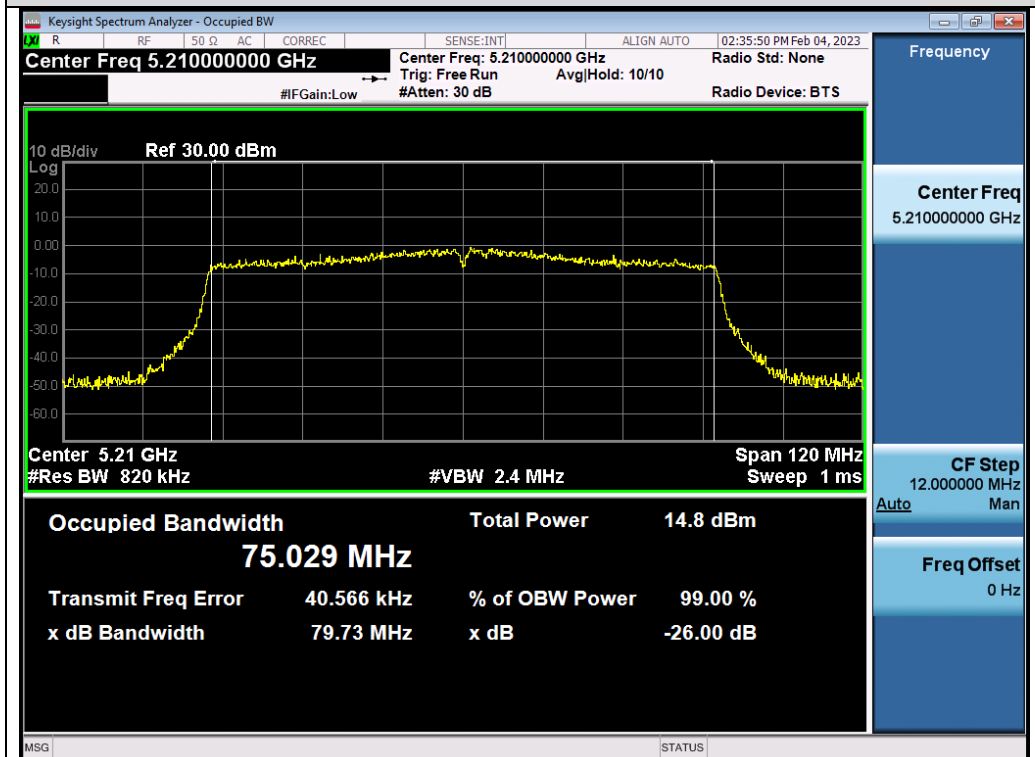

Test\_Graph\_802.11ac80\_ANT2\_5210\_MCS9\_OBW

Any report having not been signed by authorized approver, or having been altered without authorization, or having not been stamped by the "Dedicated Testing/Inspection Stamp" is deemed to be invalid. Copying or excerpting portion of, or altering the content of the report is not permitted without the written authorization of AGC. The test results presented in the report apply only to the tested sample. Any objections to report issued by AGC should be submitted to AGC within 15days after the issuance of the test report. Further enquiry of validity or verification of the test report should be addressed to AGC by agc01@agccert.com.



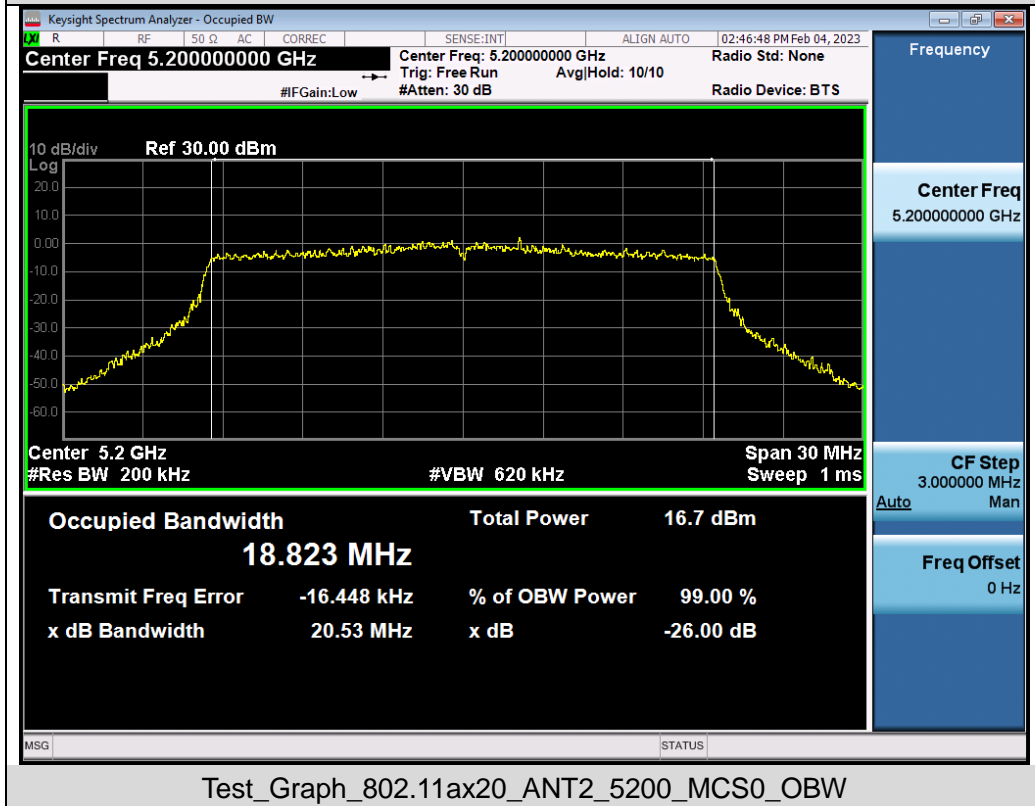
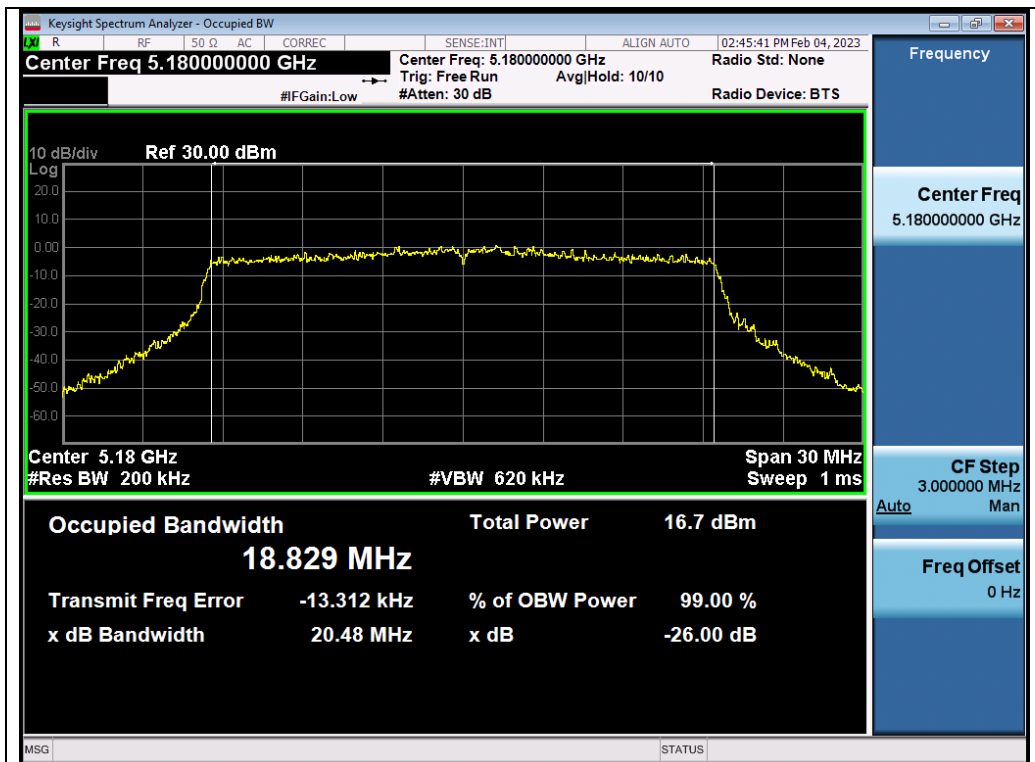

Any report having not been signed by authorized approver, or having been altered without authorization, or having not been stamped by the "Dedicated Testing/Inspection Stamp" is deemed to be invalid. Copying or excerpting portion of, or altering the content of the report is not permitted without the written authorization of AGC. The test results presented in the report apply only to the tested sample. Any objections to report issued by AGC should be submitted to AGC within 15days after the issuance of the test report. Further enquiry of validity or verification of the test report should be addressed to AGC by agc01@agccert.com.

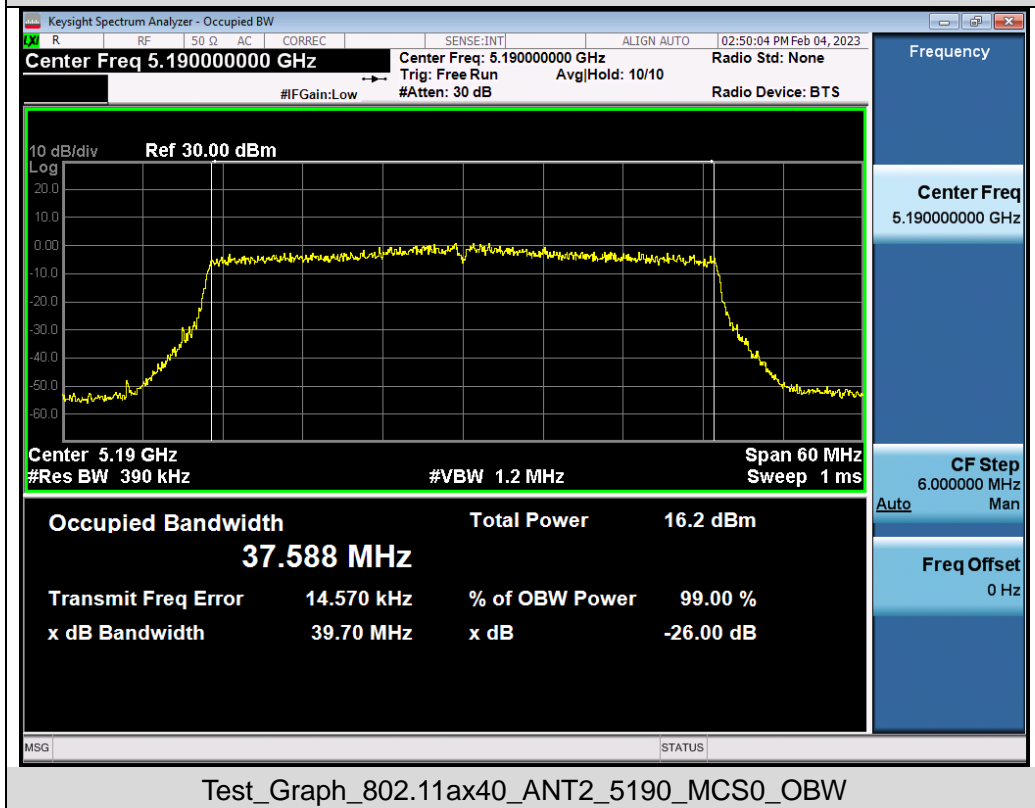
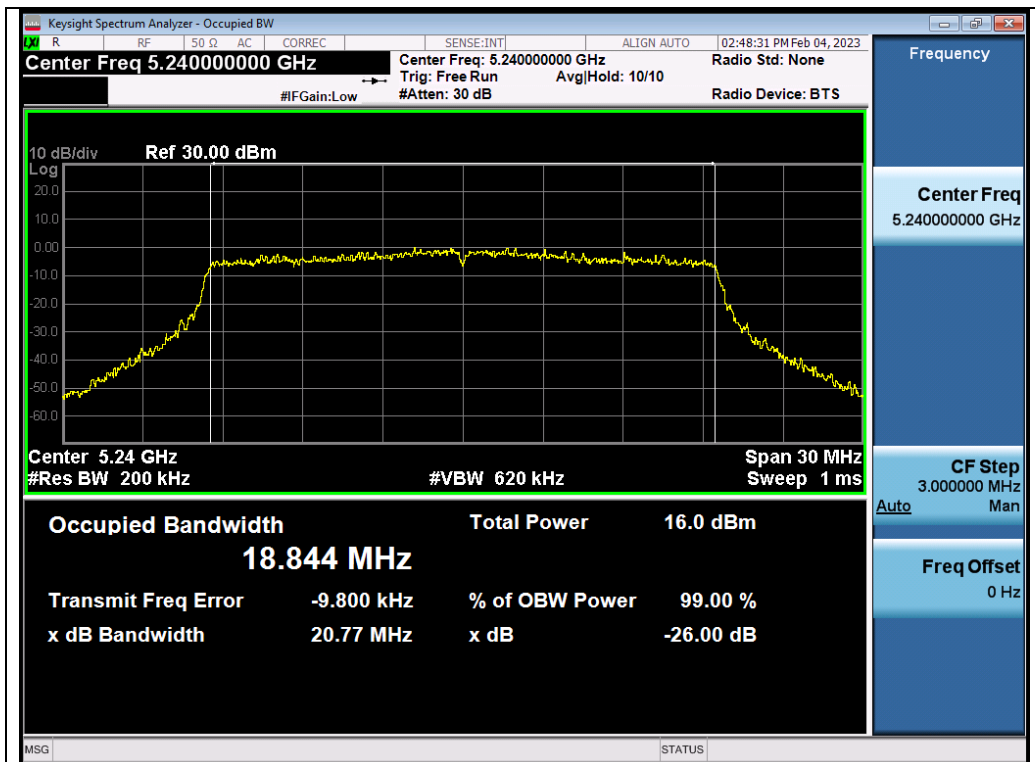

Any report having not been signed by authorized approver, or having been altered without authorization, or having not been stamped by the "Dedicated Testing/Inspection Stamp" is deemed to be invalid. Copying or excerpting portion of, or altering the content of the report is not permitted without the written authorization of AGC. The test results presented in the report apply only to the tested sample. Any objections to report issued by AGC should be submitted to AGC within 15days after the issuance of the test report. Further enquiry of validity or verification of the test report should be addressed to AGC by agc01@agccert.com.



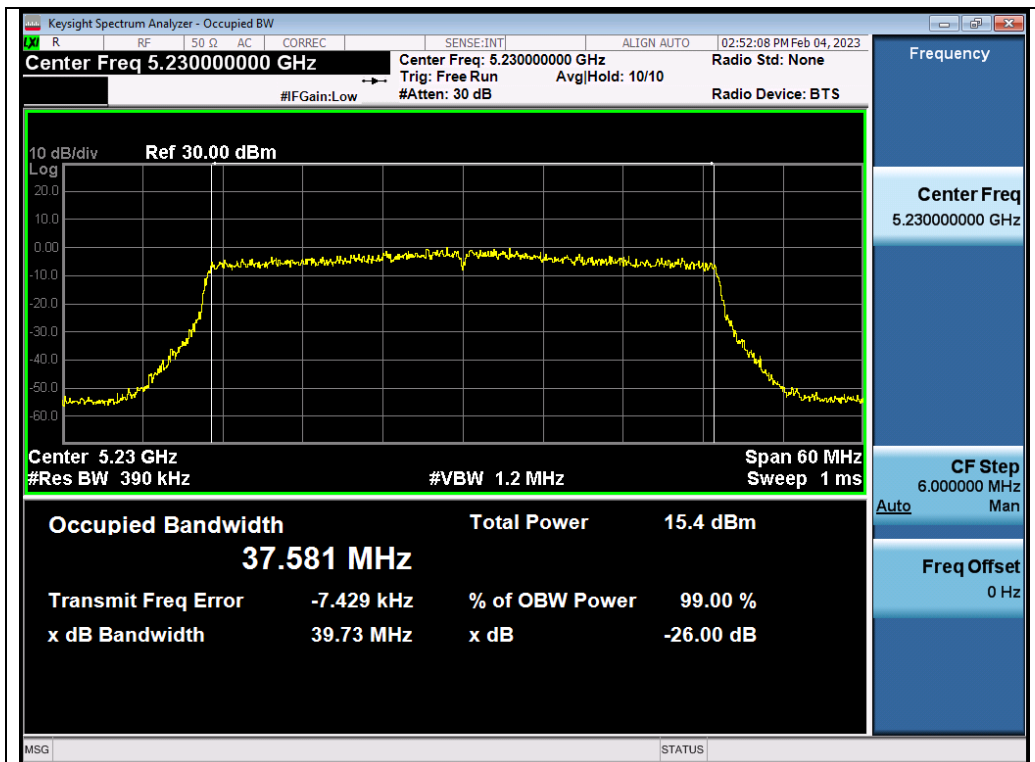

Test\_Graph\_802.11ax40\_ANT2\_5230\_MCS0\_OBW

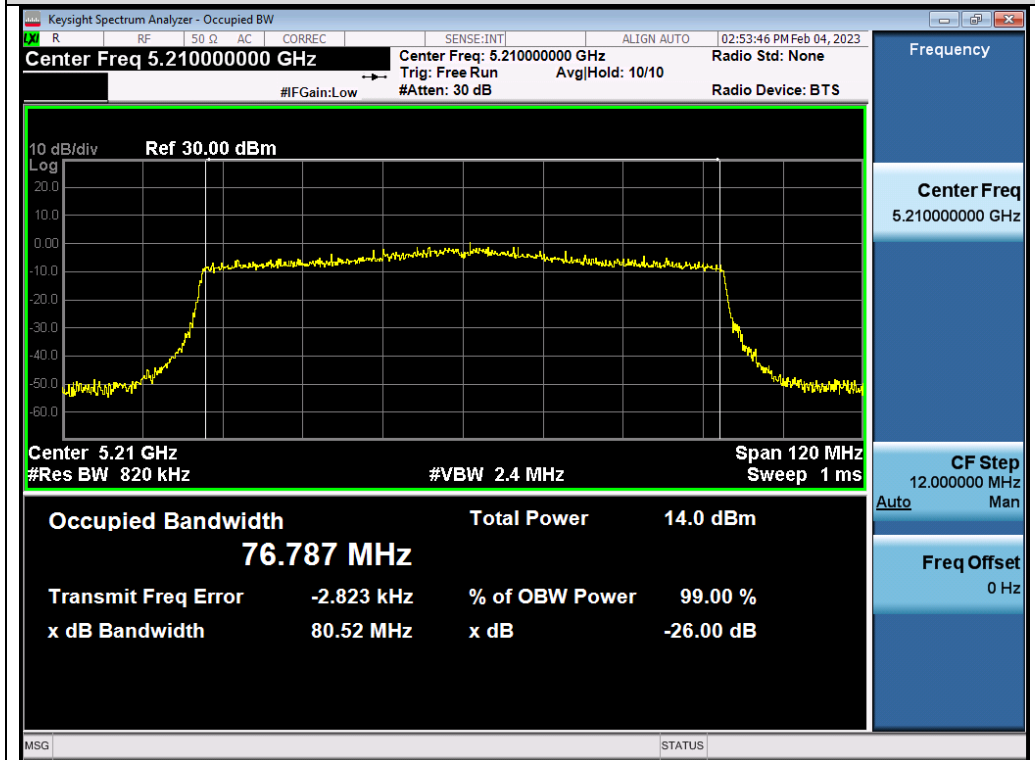

Test\_Graph\_802.11ax80\_ANT2\_5210\_MCS0\_OBW

Any report having not been signed by authorized approver, or having been altered without authorization, or having not been stamped by the "Dedicated Testing/Inspection Stamp" is deemed to be invalid. Copying or excerpting portion of, or altering the content of the report is not permitted without the written authorization of AGC. The test results presented in the report apply only to the tested sample. Any objections to report issued by AGC should be submitted to AGC within 15days after the issuance of the test report. Further enquiry of validity or verification of the test report should be addressed to AGC by agc01@agccert.com.

### Test Graphs of Occupied Bandwidth for band 5.25-5.35 GHz

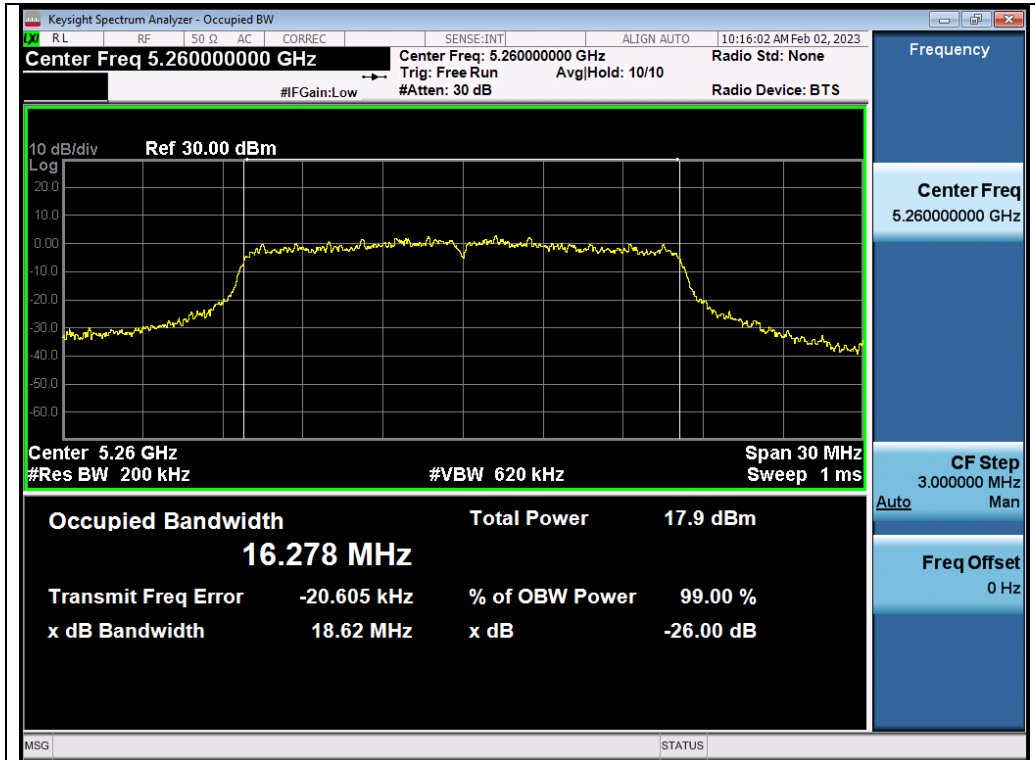

Test\_Graph\_802.11a\_ANT1\_5260\_6Mbps\_OBW

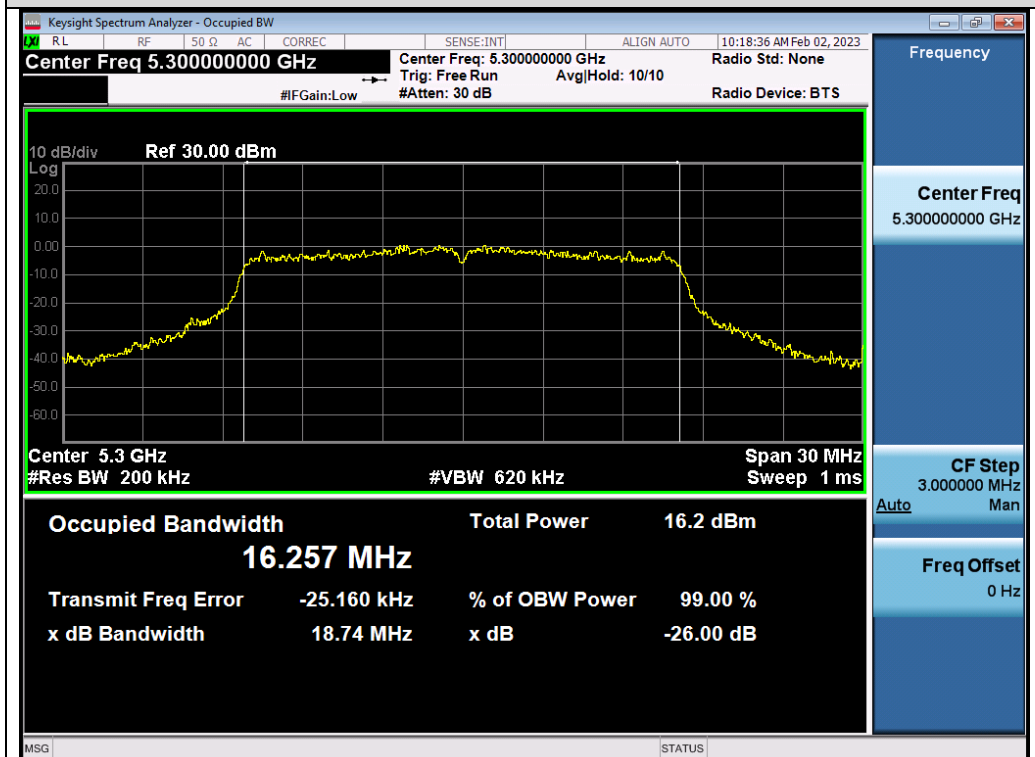

Test\_Graph\_802.11a\_ANT1\_5300\_6Mbps\_OBW

Any report having not been signed by authorized approver, or having been altered without authorization, or having not been stamped by the "Dedicated Testing/Inspection Stamp" is deemed to be invalid. Copying or excerpting portion of, or altering the content of the report is not permitted without the written authorization of AGC. The test results presented in the report apply only to the tested sample. Any objections to report issued by AGC should be submitted to AGC within 15 days after the issuance of the test report. Further enquiry of validity or verification of the test report should be addressed to AGC by agc01@agccert.com.

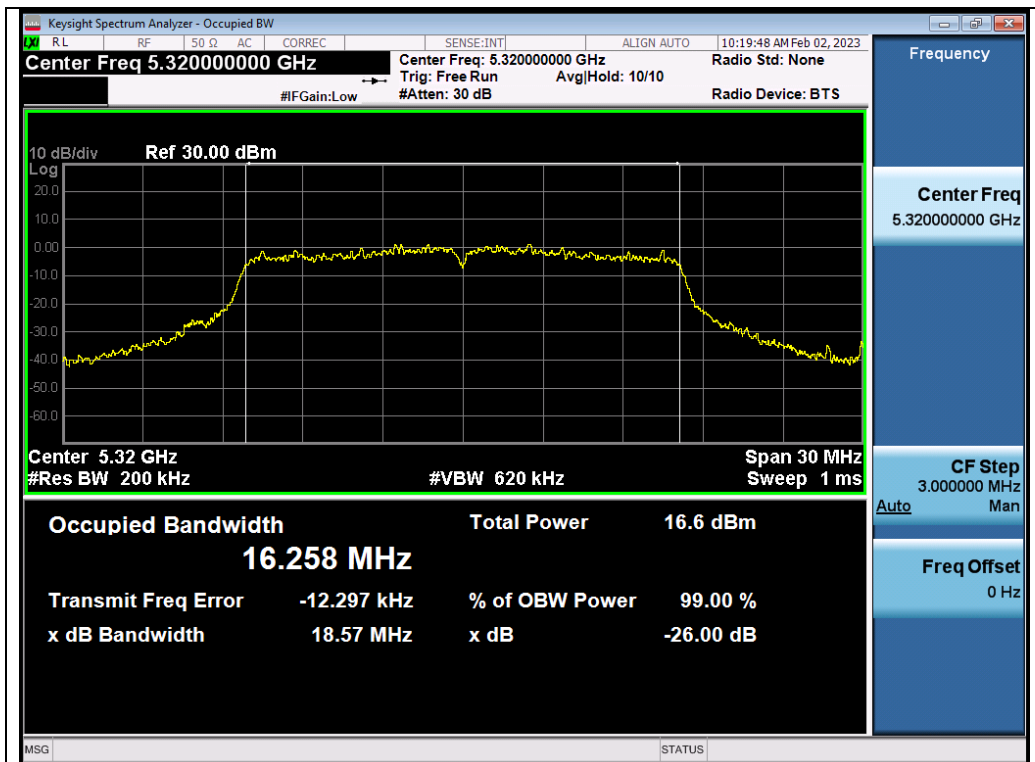

Test\_Graph\_802.11a\_ANT1\_5320\_6Mbps\_OBW

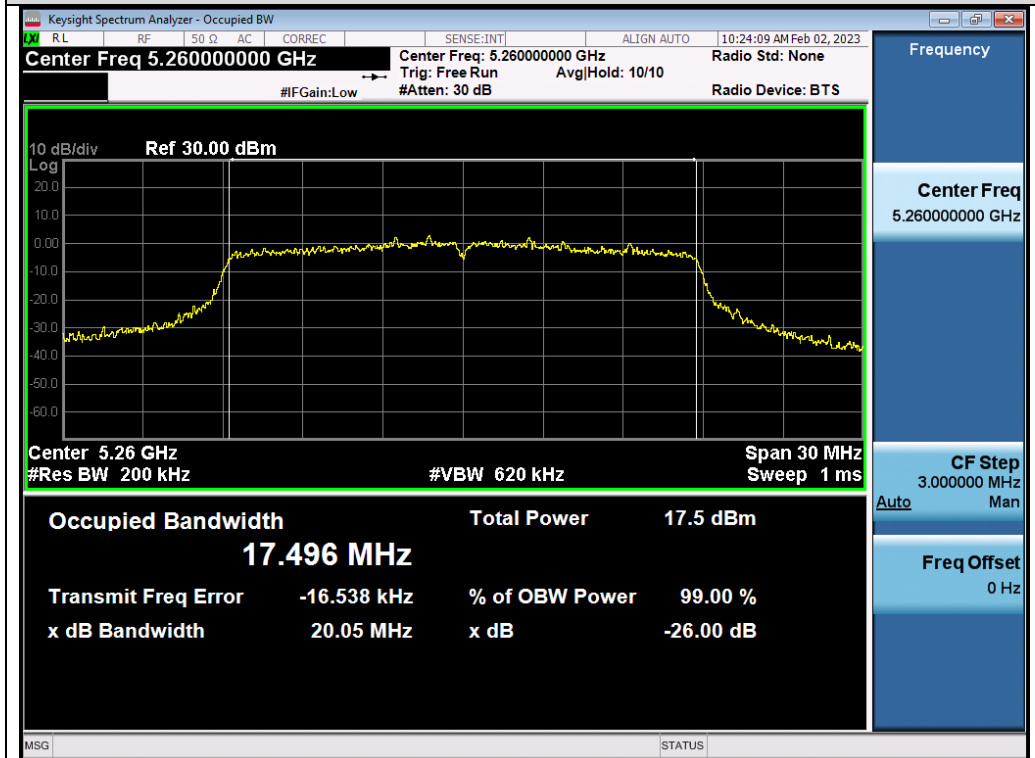

Test\_Graph\_802.11n20\_ANT1\_5260\_MCS0\_OBW

Any report having not been signed by authorized approver, or having been altered without authorization, or having not been stamped by the "Dedicated Testing/Inspection Stamp" is deemed to be invalid. Copying or excerpting portion of, or altering the content of the report is not permitted without the written authorization of AGC. The test results presented in the report apply only to the tested sample. Any objections to report issued by AGC should be submitted to AGC within 15days after the issuance of the test report. Further enquiry of validity or verification of the test report should be addressed to AGC by agc01@agccert.com.

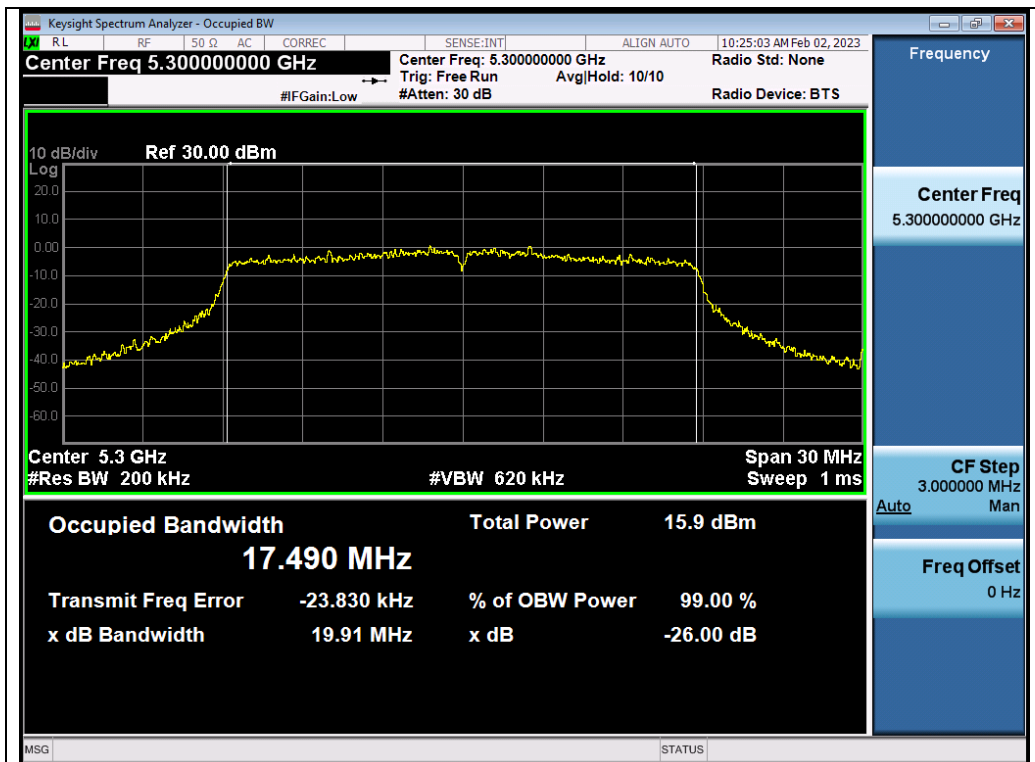

Test\_Graph\_802.11n20\_ANT1\_5300\_MCS0\_OBW

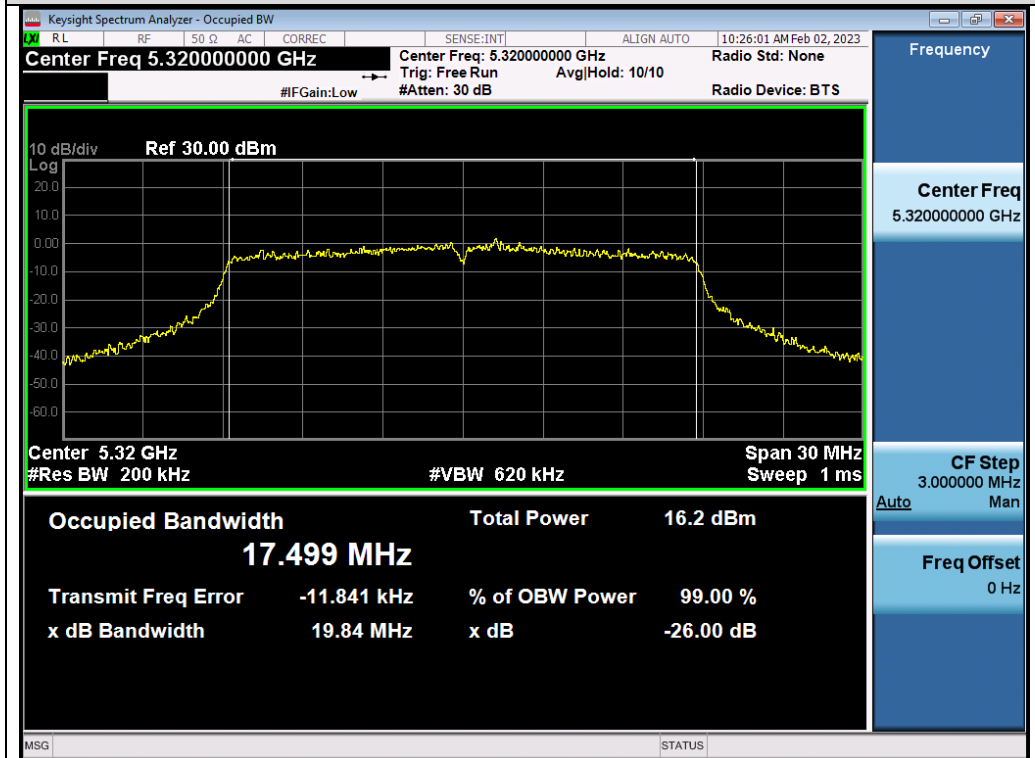

Test\_Graph\_802.11n20\_ANT1\_5320\_MCS0\_OBW

Any report having not been signed by authorized approver, or having been altered without authorization, or having not been stamped by the "Dedicated Testing/Inspection Stamp" is deemed to be invalid. Copying or excerpting portion of, or altering the content of the report is not permitted without the written authorization of AGC. The test results presented in the report apply only to the tested sample. Any objections to report issued by AGC should be submitted to AGC within 15days after the issuance of the test report. Further enquiry of validity or verification of the test report should be addressed to AGC by agc01@agccert.com.

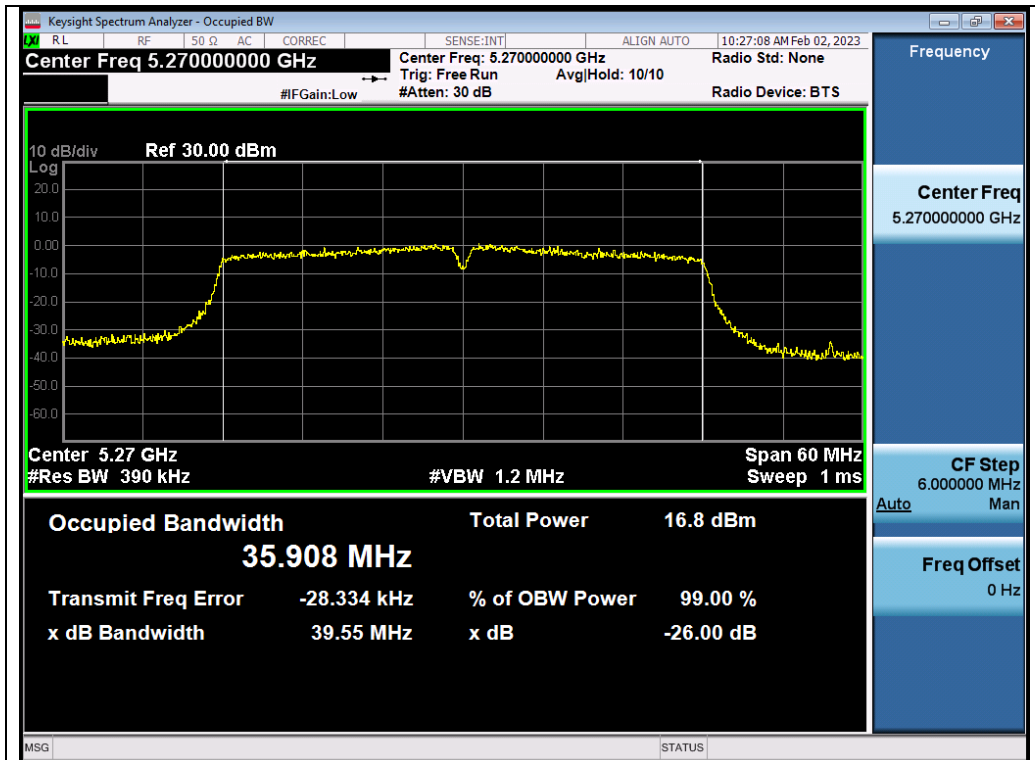

Test\_Graph\_802.11n40\_ANT1\_5270\_MCS0\_OBW

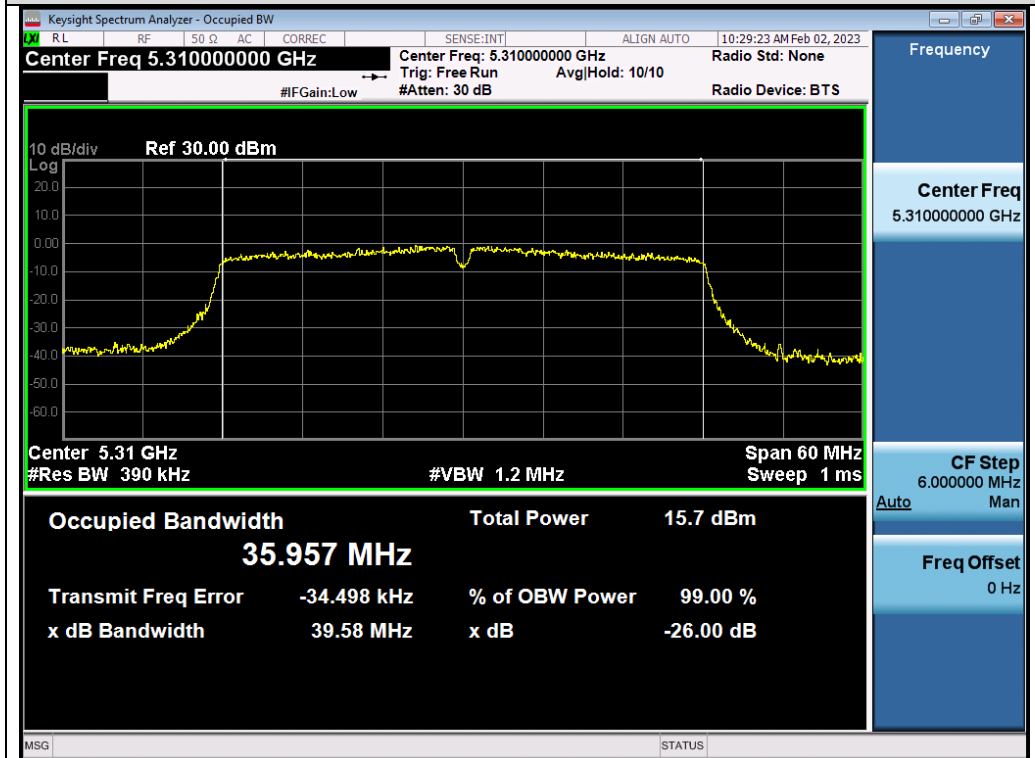

Test\_Graph\_802.11n40\_ANT1\_5310\_MCS0\_OBW

Any report having not been signed by authorized approver, or having been altered without authorization, or having not been stamped by the "Dedicated Testing/Inspection Stamp" is deemed to be invalid. Copying or excerpting portion of, or altering the content of the report is not permitted without the written authorization of AGC. The test results presented in the report apply only to the tested sample. Any objections to report issued by AGC should be submitted to AGC within 15days after the issuance of the test report. Further enquiry of validity or verification of the test report should be addressed to AGC by agc01@agccert.com.



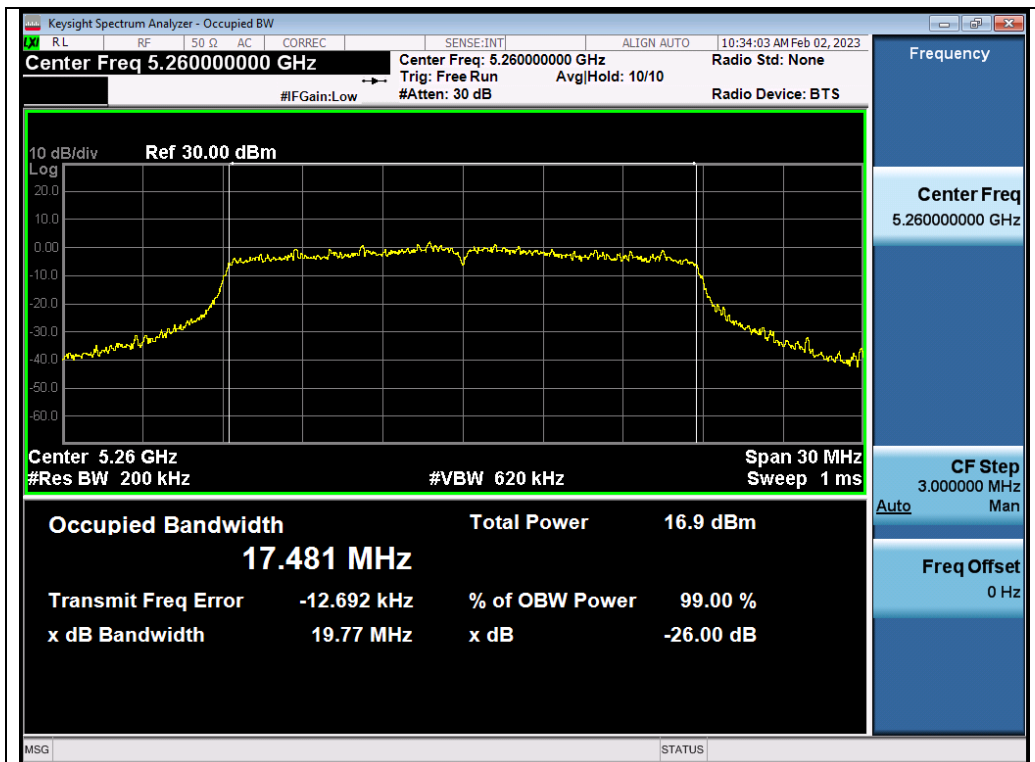

Test\_Graph\_802.11ac20\_ANT1\_5260\_MCS0\_OBW

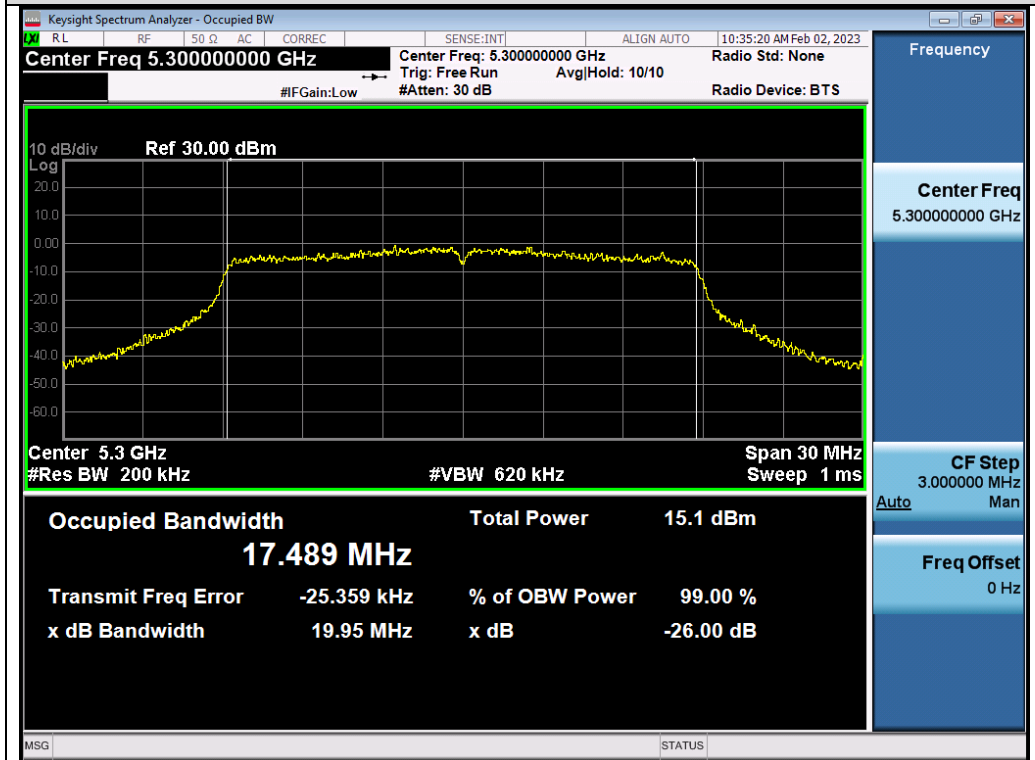

Test\_Graph\_802.11ac20\_ANT1\_5300\_MCS0\_OBW

Any report having not been signed by authorized approver, or having been altered without authorization, or having not been stamped by the "Dedicated Testing/Inspection Stamp" is deemed to be invalid. Copying or excerpting portion of, or altering the content of the report is not permitted without the written authorization of AGC. The test results presented in the report apply only to the tested sample. Any objections to report issued by AGC should be submitted to AGC within 15days after the issuance of the test report. Further enquiry of validity or verification of the test report should be addressed to AGC by agc01@agccert.com.

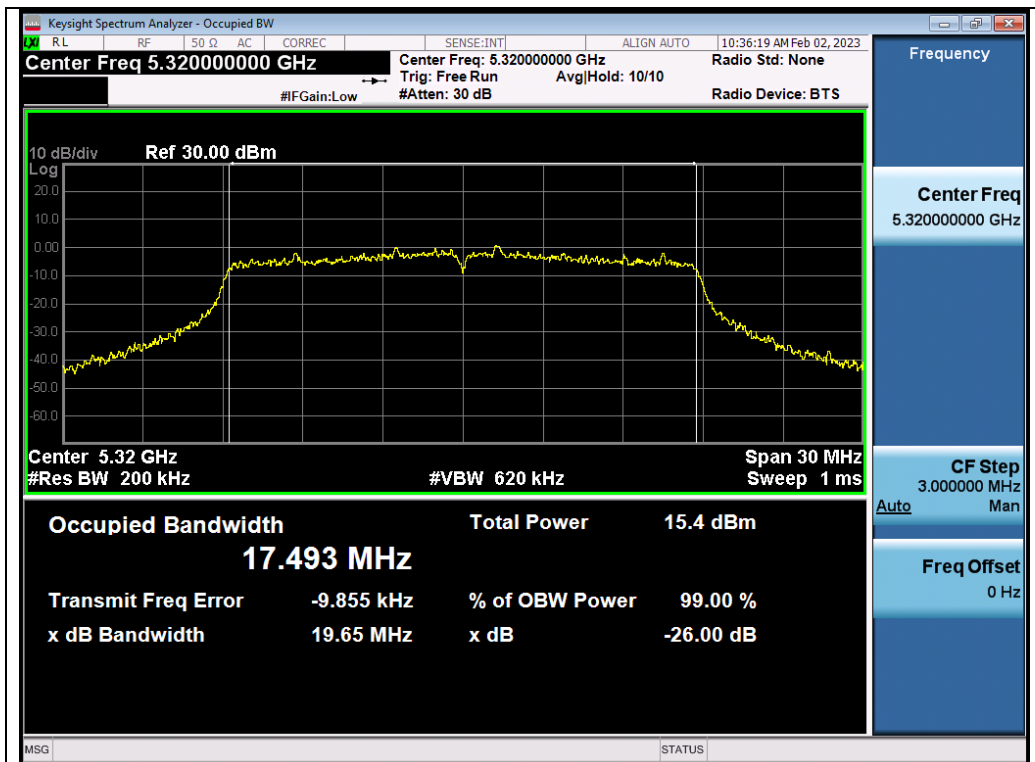

Test\_Graph\_802.11ac20\_ANT1\_5320\_MCS9\_OBW

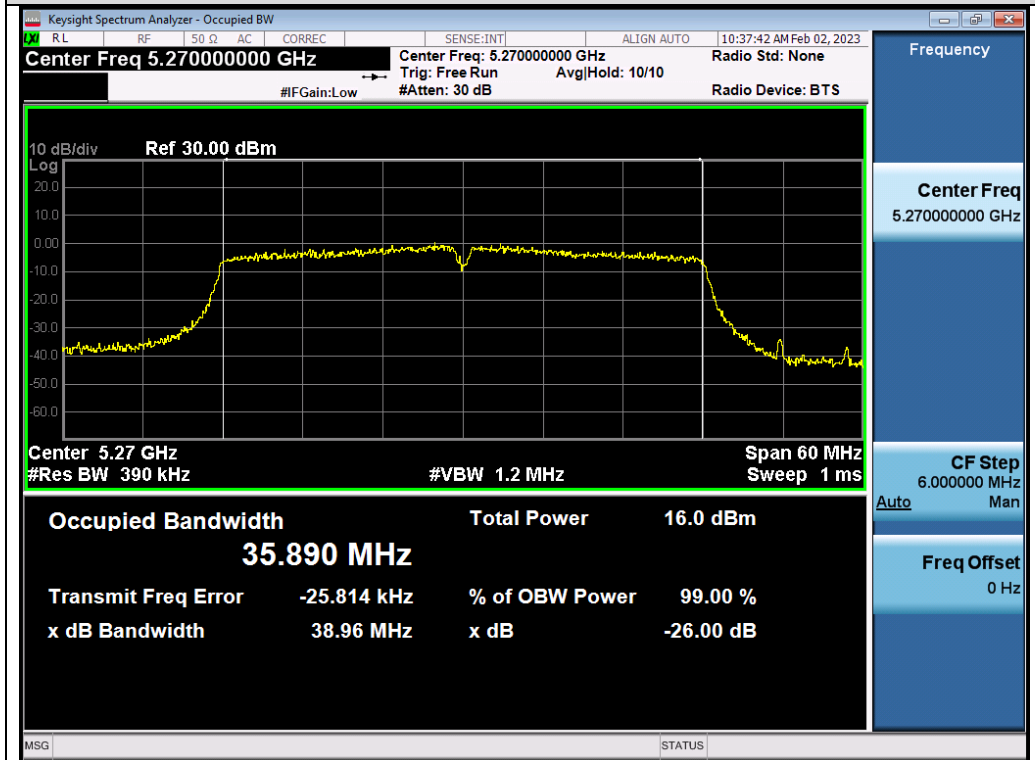

Test\_Graph\_802.11ac40\_ANT1\_5270\_MCS9\_OBW

Any report having not been signed by authorized approver, or having been altered without authorization, or having not been stamped by the "Dedicated Testing/Inspection Stamp" is deemed to be invalid. Copying or excerpting portion of, or altering the content of the report is not permitted without the written authorization of AGC. The test results presented in the report apply only to the tested sample. Any objections to report issued by AGC should be submitted to AGC within 15days after the issuance of the test report. Further enquiry of validity or verification of the test report should be addressed to AGC by agc01@agccert.com.



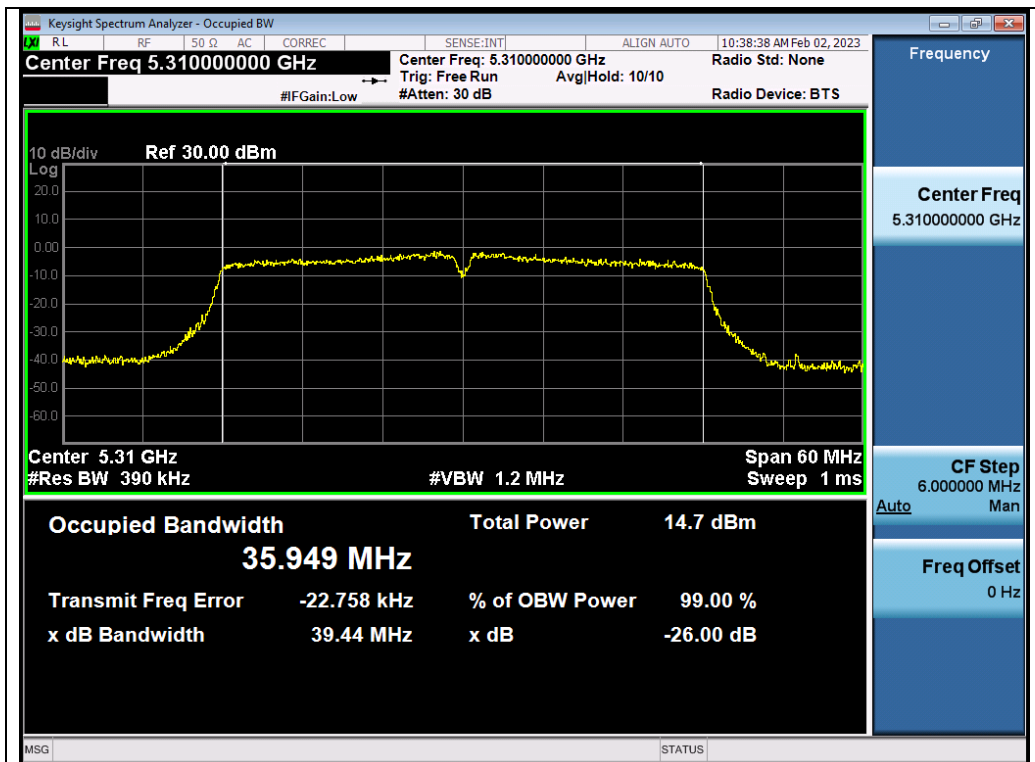

Test\_Graph\_802.11ac40\_ANT1\_5310\_MCS9\_OBW

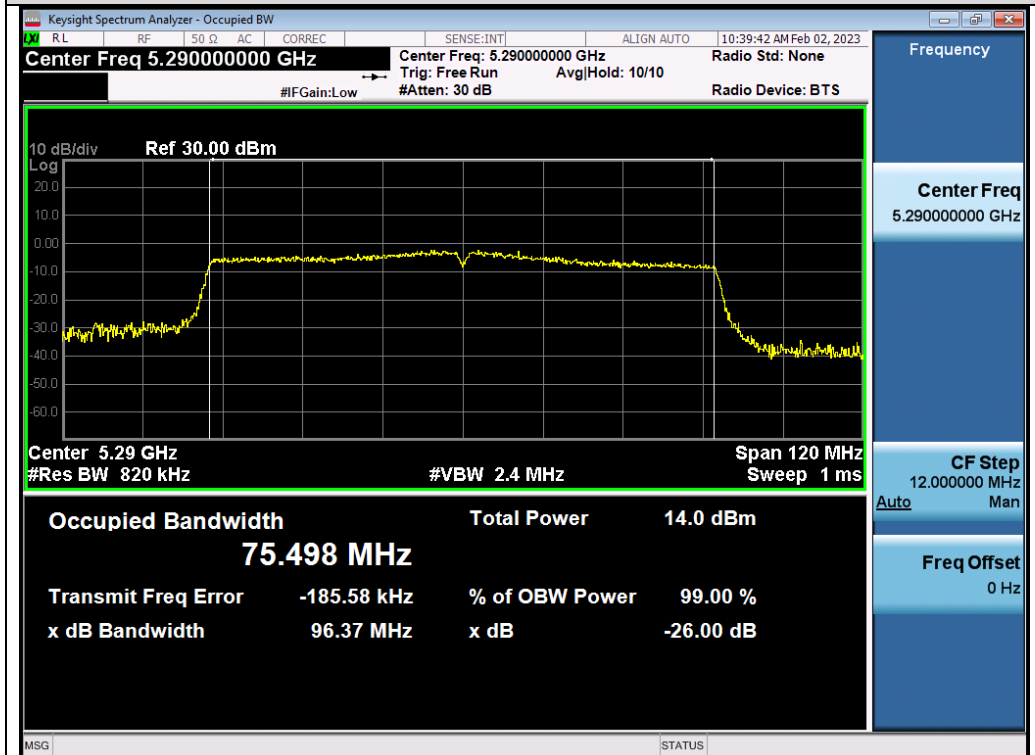

Test\_Graph\_802.11ac80\_ANT1\_5290\_MCS9\_OBW

Any report having not been signed by authorized approver, or having been altered without authorization, or having not been stamped by the "Dedicated Testing/Inspection Stamp" is deemed to be invalid. Copying or excerpting portion of, or altering the content of the report is not permitted without the written authorization of AGC. The test results presented in the report apply only to the tested sample. Any objections to report issued by AGC should be submitted to AGC within 15days after the issuance of the test report. Further enquiry of validity or verification of the test report should be addressed to AGC by agc01@agccert.com.

Attestation of Global Compliance(Shenzhen)Co., Ltd  
Attestation of Global Compliance(Shenzhen)Std & Tech Co., Ltd  
Tel: +86-755 2523 4088 E-mail: agc@agccert.com Web: http://www.agccert.com/

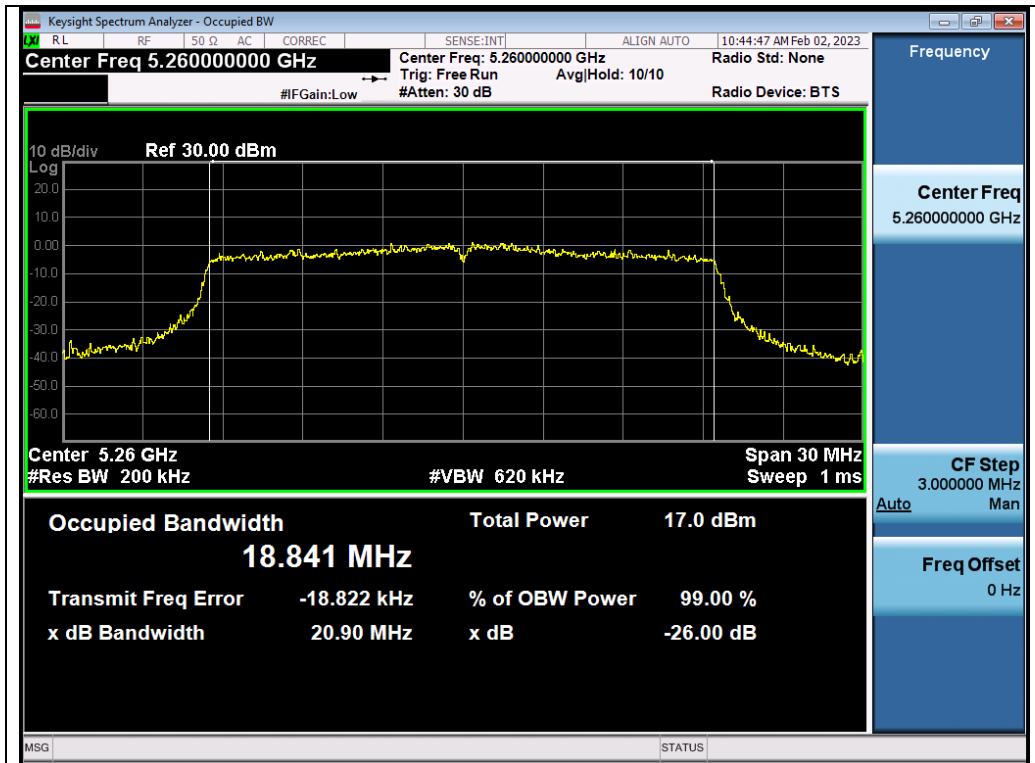

Test\_Graph\_802.11ax20\_ANT1\_5260\_MCS0\_OBW

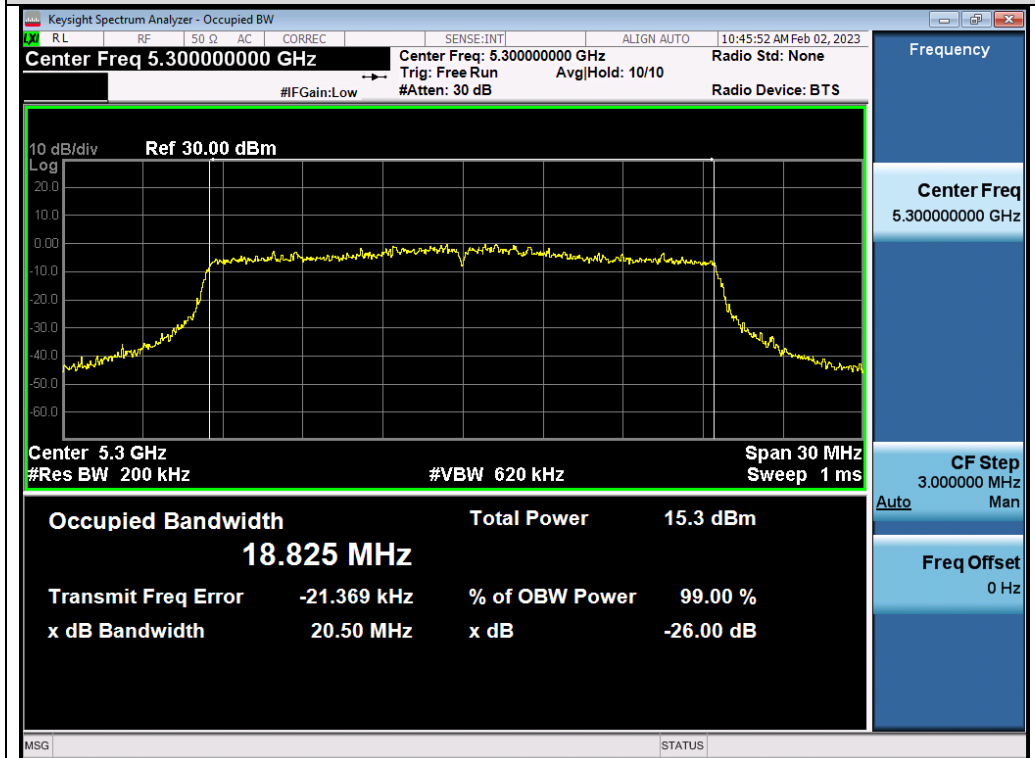

Test\_Graph\_802.11ax20\_ANT1\_5300\_MCS0\_OBW

Any report having not been signed by authorized approver, or having been altered without authorization, or having not been stamped by the "Dedicated Testing/Inspection Stamp" is deemed to be invalid. Copying or excerpting portion of, or altering the content of the report is not permitted without the written authorization of AGC. The test results presented in the report apply only to the tested sample. Any objections to report issued by AGC should be submitted to AGC within 15days after the issuance of the test report. Further enquiry of validity or verification of the test report should be addressed to AGC by agc01@agccert.com.

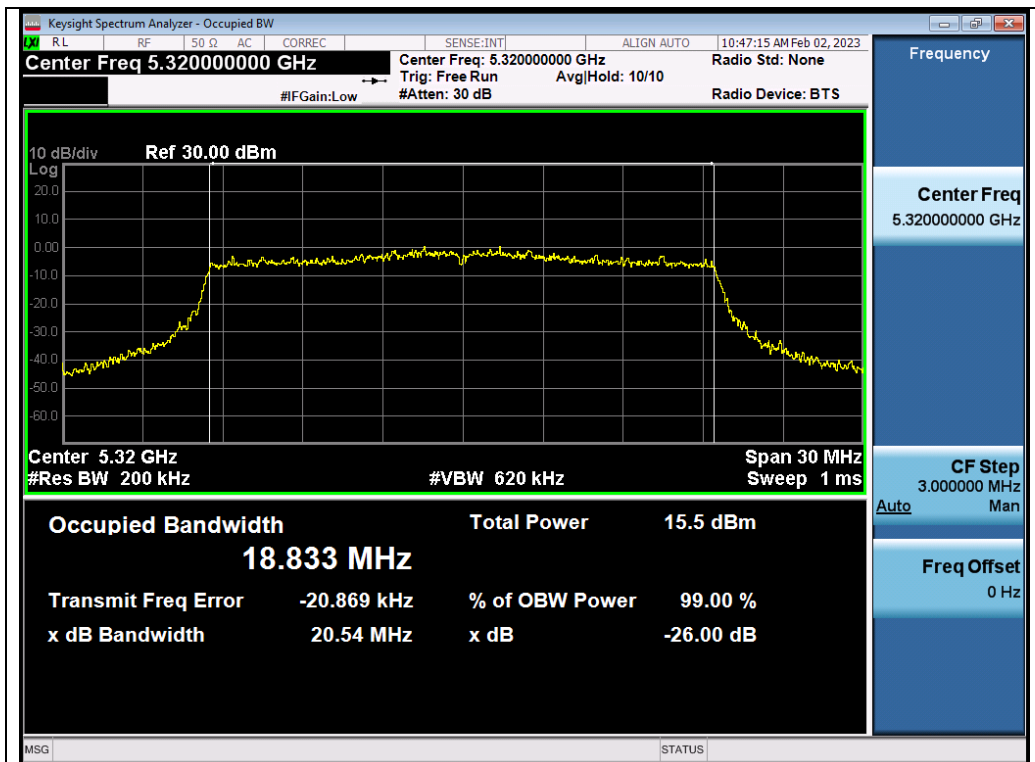

Test\_Graph\_802.11ax20\_ANT1\_5320\_MCS0\_OBW

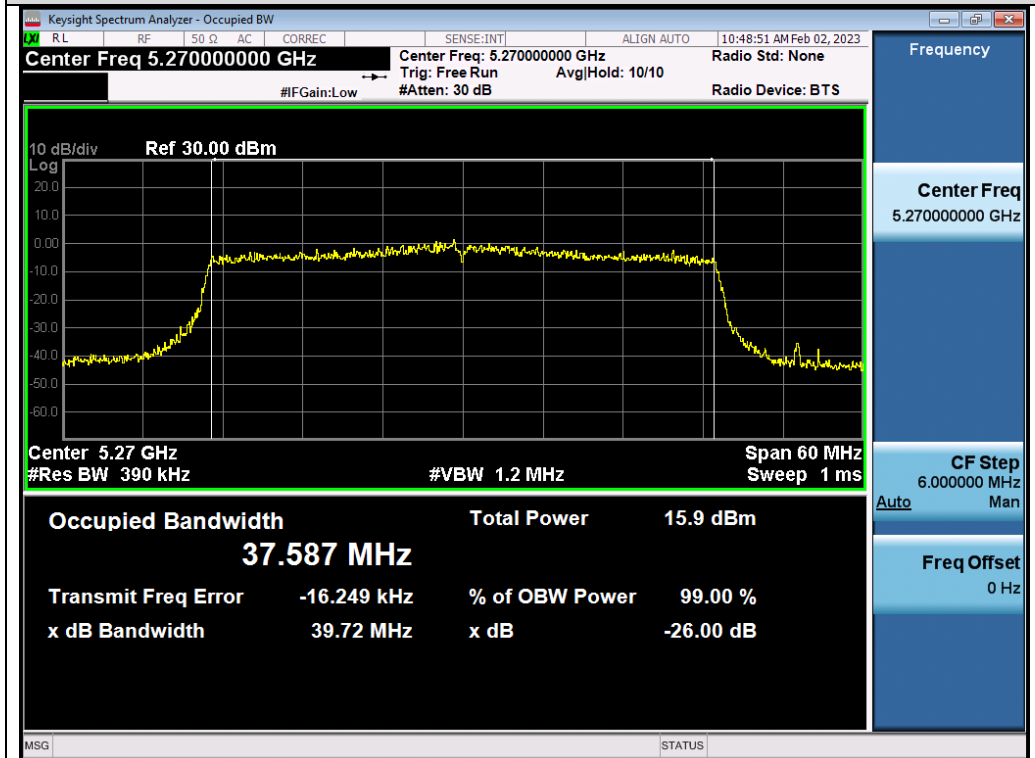

Test\_Graph\_802.11ax40\_ANT1\_5270\_MCS0\_OBW

Any report having not been signed by authorized approver, or having been altered without authorization, or having not been stamped by the "Dedicated Testing/Inspection Stamp" is deemed to be invalid. Copying or excerpting portion of, or altering the content of the report is not permitted without the written authorization of AGC. The test results presented in the report apply only to the tested sample. Any objections to report issued by AGC should be submitted to AGC within 15days after the issuance of the test report. Further enquiry of validity or verification of the test report should be addressed to AGC by agc01@agccert.com.

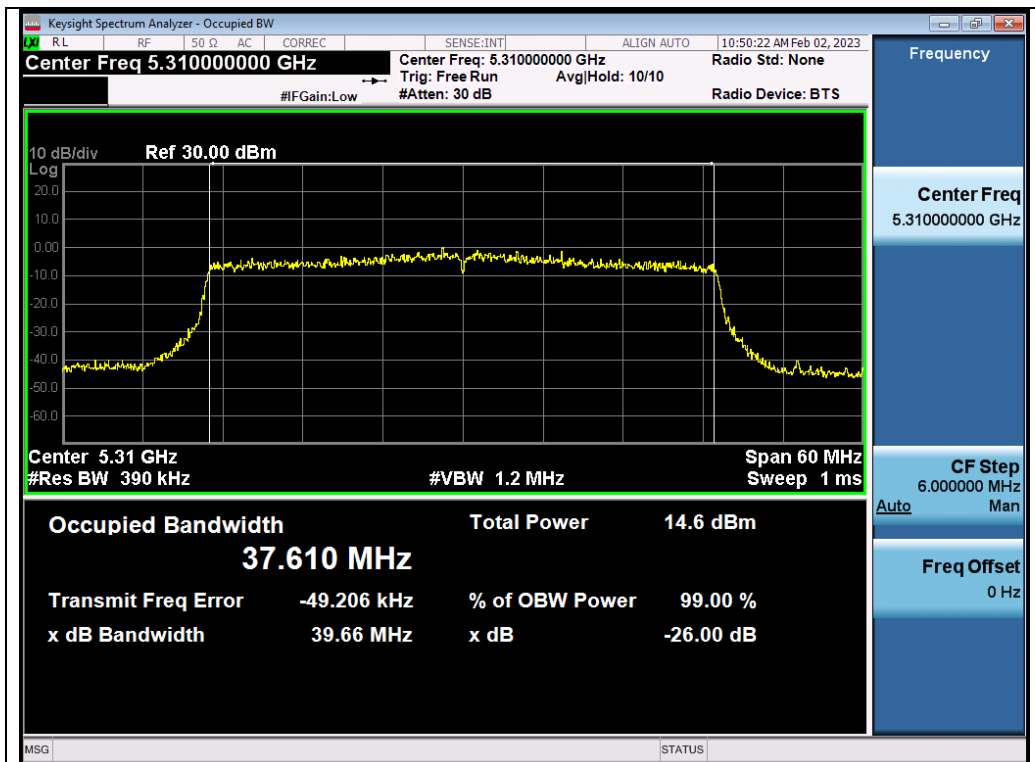

Test\_Graph\_802.11ax40\_ANT1\_5310\_MCS0\_OBW

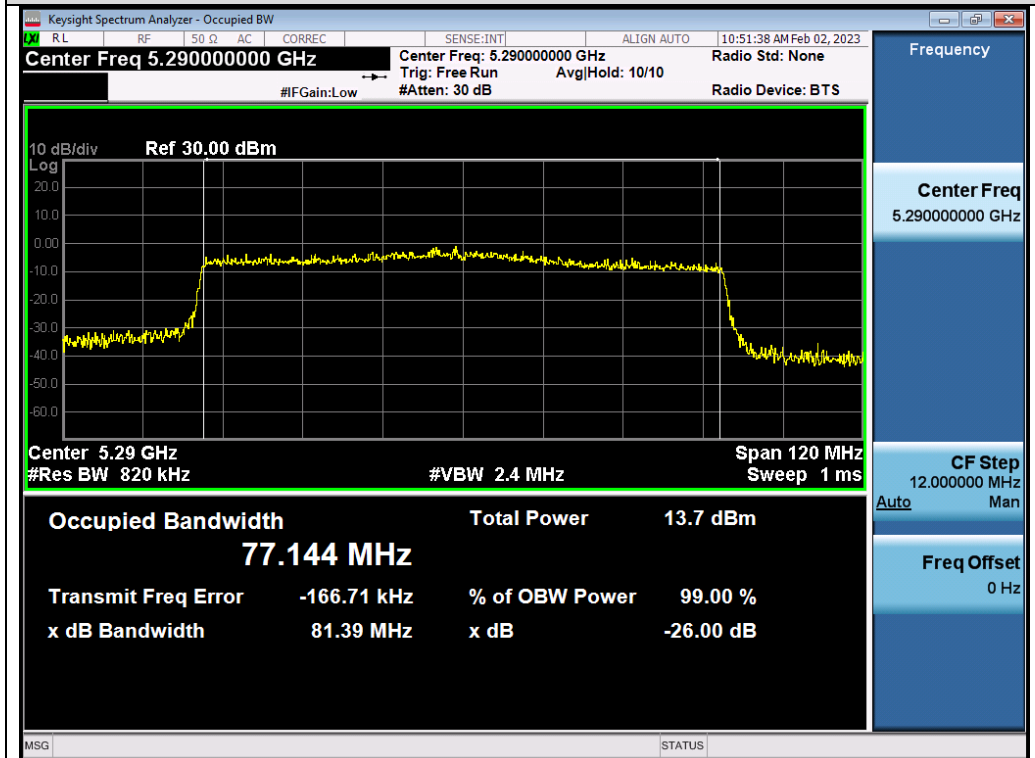

Test\_Graph\_802.11ax80\_ANT1\_5290\_MCS0\_OBW

Any report having not been signed by authorized approver, or having been altered without authorization, or having not been stamped by the "Dedicated Testing/Inspection Stamp" is deemed to be invalid. Copying or excerpting portion of, or altering the content of the report is not permitted without the written authorization of AGC. The test results presented in the report apply only to the tested sample. Any objections to report issued by AGC should be submitted to AGC within 15days after the issuance of the test report. Further enquiry of validity or verification of the test report should be addressed to AGC by agc01@agccert.com.

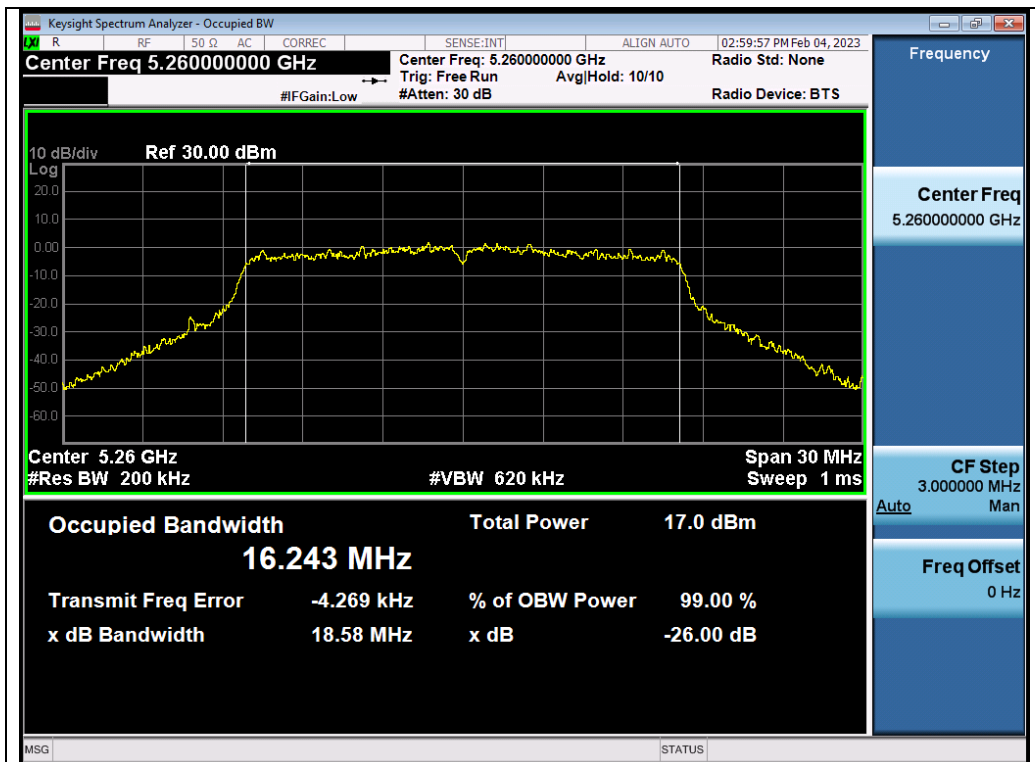

Test\_Graph\_802.11a\_ANT2\_5260\_6Mbps\_OBW

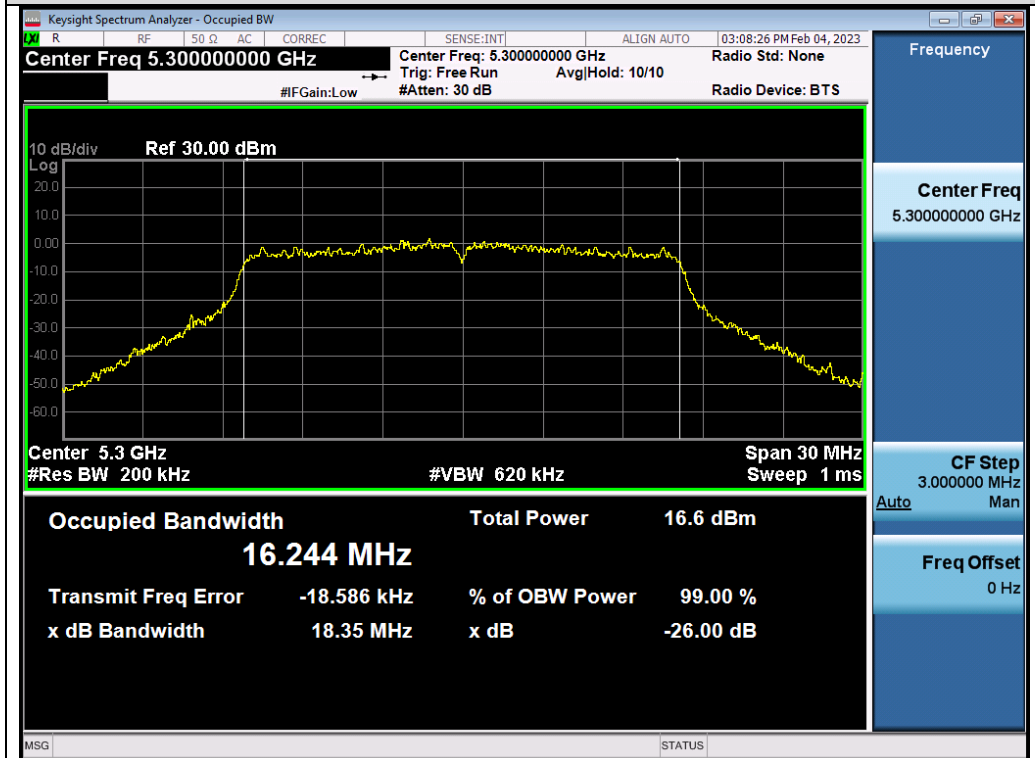

Test\_Graph\_802.11a\_ANT2\_5300\_6Mbps\_OBW

Any report having not been signed by authorized approver, or having been altered without authorization, or having not been stamped by the "Dedicated Testing/Inspection Stamp" is deemed to be invalid. Copying or excerpting portion of, or altering the content of the report is not permitted without the written authorization of AGC. The test results presented in the report apply only to the tested sample. Any objections to report issued by AGC should be submitted to AGC within 15days after the issuance of the test report. Further enquiry of validity or verification of the test report should be addressed to AGC by agc01@agccert.com.



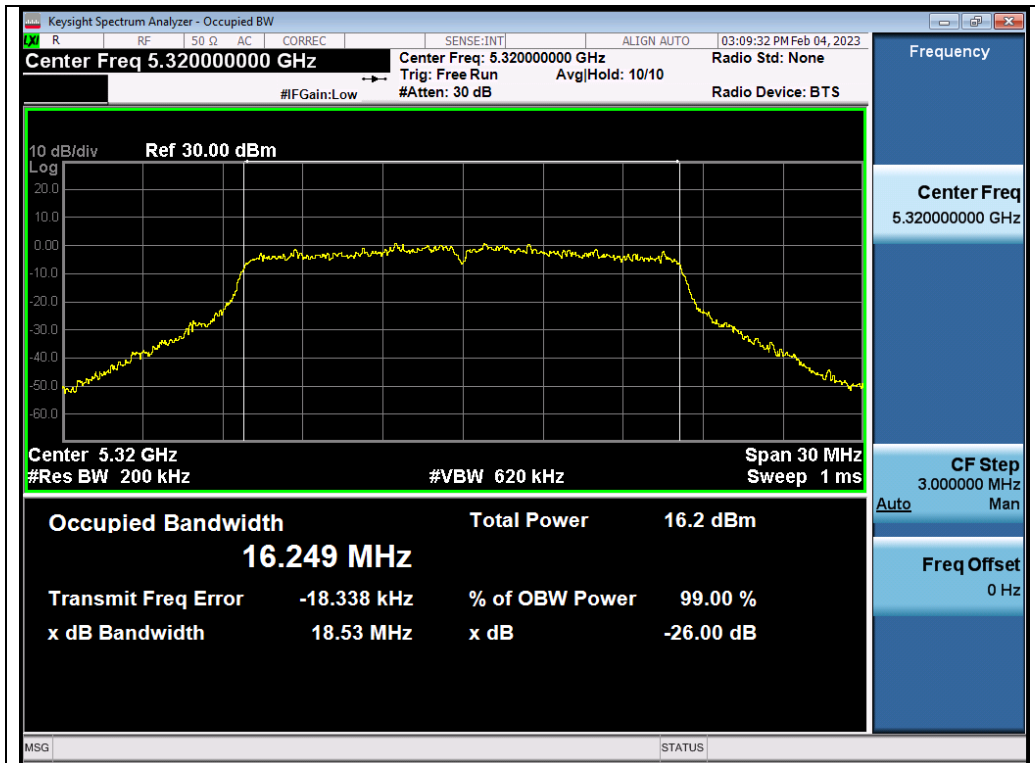

Test\_Graph\_802.11a\_ANT2\_5320\_6Mbps\_OBW

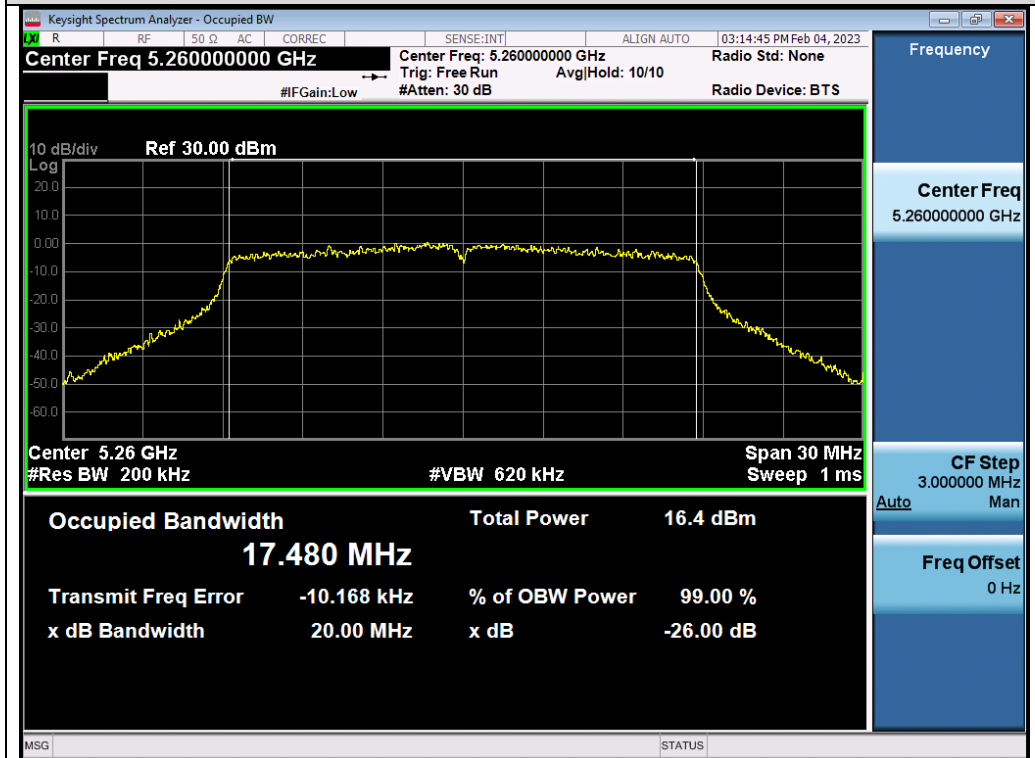

Test\_Graph\_802.11n20\_ANT2\_5260\_MCS0\_OBW

Any report having not been signed by authorized approver, or having been altered without authorization, or having not been stamped by the "Dedicated Testing/Inspection Stamp" is deemed to be invalid. Copying or excerpting portion of, or altering the content of the report is not permitted without the written authorization of AGC. The test results presented in the report apply only to the tested sample. Any objections to report issued by AGC should be submitted to AGC within 15days after the issuance of the test report. Further enquiry of validity or verification of the test report should be addressed to AGC by agc01@agccert.com.



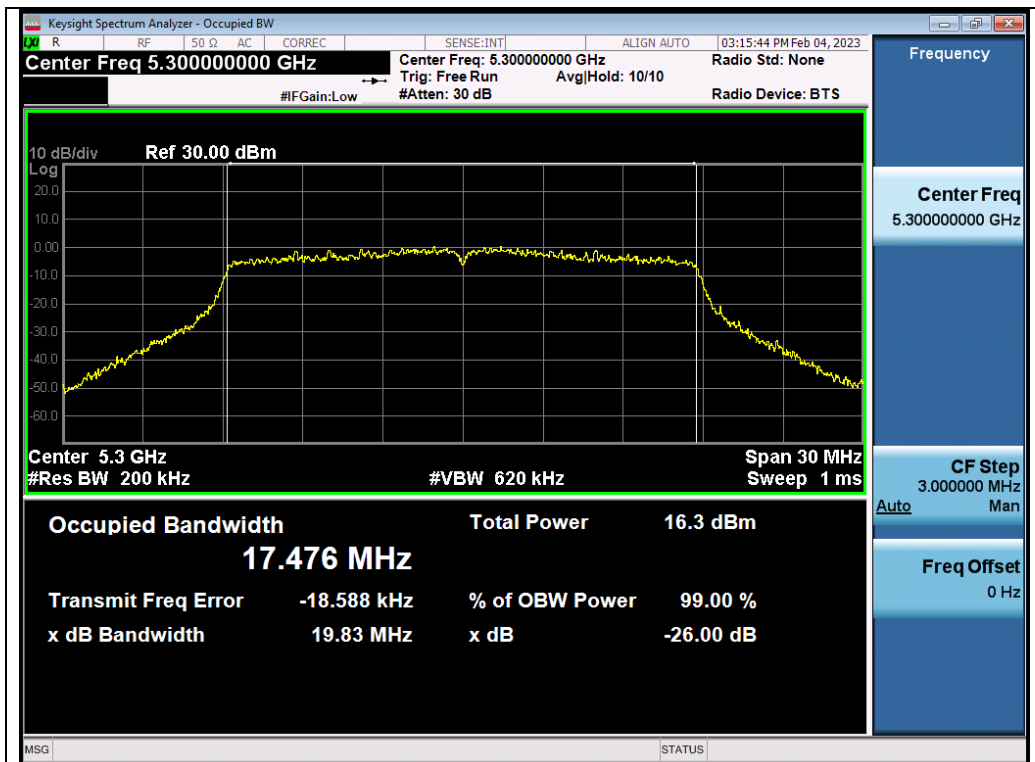

Test\_Graph\_802.11n20\_ANT2\_5300\_MCS0\_OBW

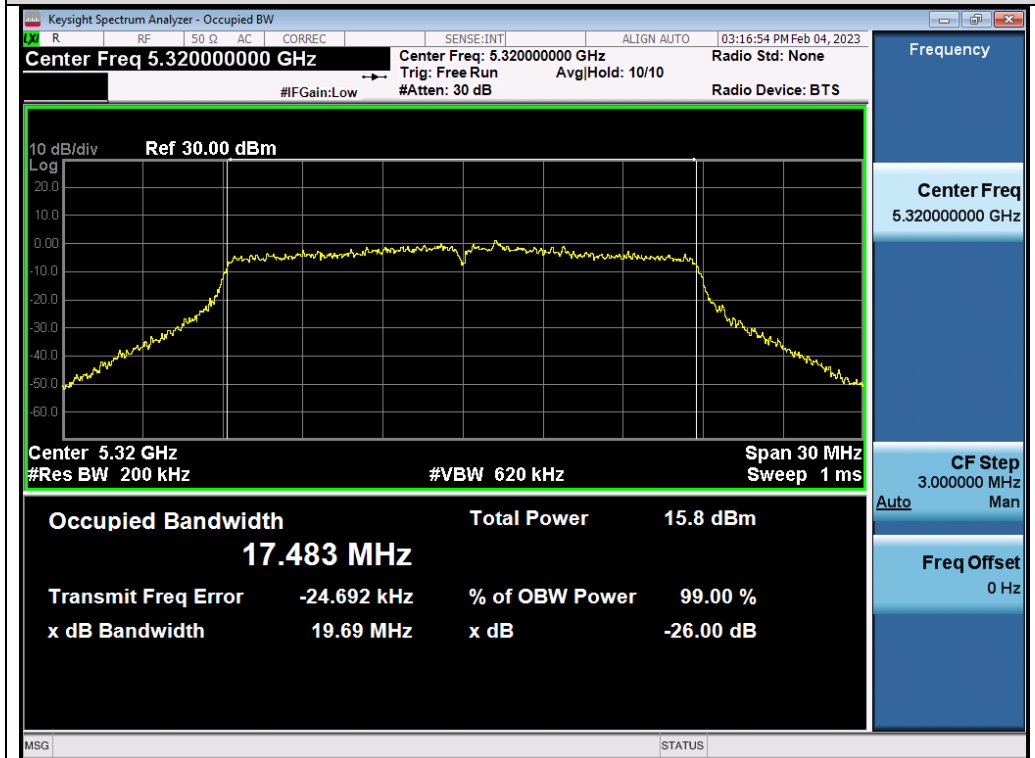

Test\_Graph\_802.11n20\_ANT2\_5320\_MCS0\_OBW

Any report having not been signed by authorized approver, or having been altered without authorization, or having not been stamped by the "Dedicated Testing/Inspection Stamp" is deemed to be invalid. Copying or excerpting portion of, or altering the content of the report is not permitted without the written authorization of AGC. The test results presented in the report apply only to the tested sample. Any objections to report issued by AGC should be submitted to AGC within 15days after the issuance of the test report. Further enquiry of validity or verification of the test report should be addressed to AGC by agc01@agccert.com.

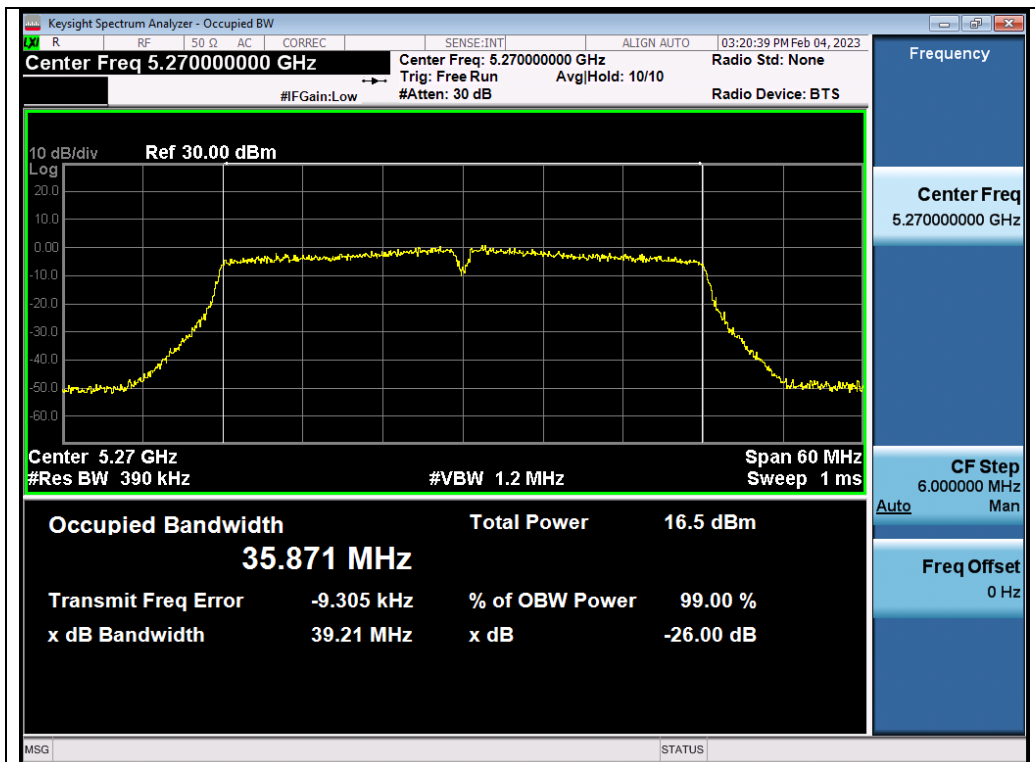

Test\_Graph\_802.11n40\_ANT2\_5270\_MCS0\_OBW

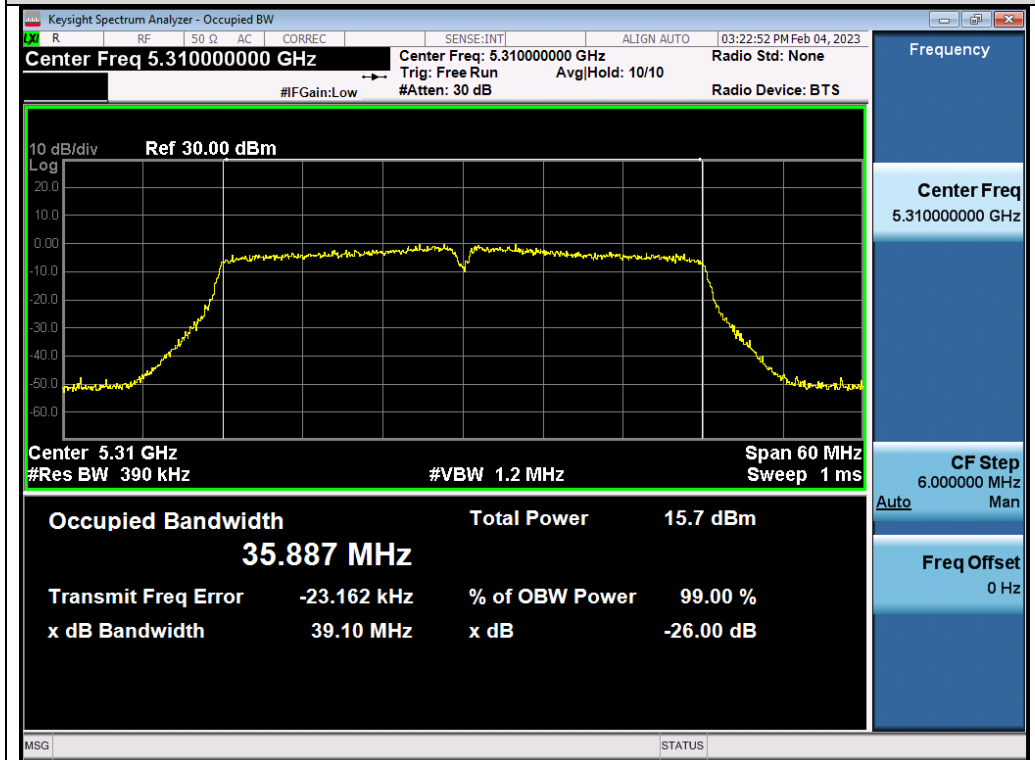

Test\_Graph\_802.11n40\_ANT2\_5310\_MCS0\_OBW

Any report having not been signed by authorized approver, or having been altered without authorization, or having not been stamped by the "Dedicated Testing/Inspection Stamp" is deemed to be invalid. Copying or excerpting portion of, or altering the content of the report is not permitted without the written authorization of AGC. The test results presented in the report apply only to the tested sample. Any objections to report issued by AGC should be submitted to AGC within 15days after the issuance of the test report. Further enquiry of validity or verification of the test report should be addressed to AGC by agc01@agccert.com.