



■ Report No.: DDT-RE23081405-1E01

■ Issued Date: Sep. 08, 2023

# FCC CERTIFICATION TEST REPORT

## FOR

<b>Applicant</b>	:	Dongguan ITC Lighting Manufacturing Co., Ltd
<b>Address</b>	:	No 245 ShiHeng Avenue, XiaSha Village, Shipai Town, DongGuan City, GuanDong Province, China
<b>Equipment under Test</b>	:	Phone Holder
<b>Model No.</b>	:	VPH-AC9-BK-T, VPH-AC9-WH-T, VPH-AC9-BK-D, VPH-AC9-WH-D, VPH-AC9-BK-W, VPH-AC9-WH-W
<b>Trade Mark</b>	:	NA
<b>FCC ID</b>	:	2A3DLA00811
<b>Manufacturer</b>	:	Dongguan ITC Lighting Manufacturing Co., Ltd
<b>Address</b>	:	No 245 ShiHeng Avenue, XiaSha Village, Shipai Town, DongGuan City, GuanDong Province, China

**Issued By: Dongguan Dongdian Testing Service Co., Ltd.**

**Add.:** No. 17, Zongbu Road 2, Songshan Lake Sci&Tech, Industry Park,  
Dongguan City, Guangdong Province, China, 523808

**Tel.:** +86-0769-38826678, **E-mail:** ddt@dgddt.com, <http://www.dgddt.com>

# REPORT

## Table of Contents

	Test report declares.....	3
1	Summary of Test Results.....	5
2	General Test Information .....	6
2.1.	Description of EUT .....	6
2.2.	Accessories of EUT.....	6
2.3.	Assistant equipment used for test.....	6
2.4.	Block diagram of EUT configuration for test .....	6
2.5.	Deviations of test standard.....	7
2.6.	Test environment conditions .....	7
2.7.	Test laboratory .....	7
2.8.	Measurement uncertainty.....	8
3	Equipment Used During Test.....	9
4	20 dB Bandwidth .....	11
4.1.	Block diagram of test setup.....	11
4.2.	Limits .....	11
4.3.	Test procedure .....	11
4.4.	Test result.....	12
4.5.	Original test data .....	12
5	Radiated Emission .....	13
5.1.	Block diagram of test setup.....	13
5.2.	Limit.....	14
5.3.	Test procedure .....	14
5.4.	Test result.....	15
6	Power Line Conducted Emission.....	36
6.1.	Block diagram of test setup.....	36
6.2.	Power line conducted emission limits .....	36
6.3.	Test procedure .....	36
6.4.	Test result.....	37
7	Antenna Requirements .....	40
7.1.	Limit.....	40
7.2.	Result .....	40
8	Test Setup Photograph .....	41
9	Photos of the EUT .....	43

## Test Report Declare

<b>Applicant</b>	:	Dongguan ITC Lighting Manufacturing Co., Ltd
<b>Address</b>	:	No 245 ShiHeng Avenue, XiaSha Village, Shipai Town, DongGuan City, GuanDong Province, China
<b>Equipment under Test</b>	:	Phone Holder
<b>Model No.</b>	:	VPH-AC9-BK-T, VPH-AC9-WH-T, VPH-AC9-BK-D, VPH-AC9-WH-D, VPH-AC9-BK-W, VPH-AC9-WH-W
<b>Trade Mark</b>	:	NA
<b>Manufacturer</b>	:	Dongguan ITC Lighting Manufacturing Co., Ltd
<b>Address</b>	:	No 245 ShiHeng Avenue, XiaSha Village, Shipai Town, DongGuan City, GuanDong Province, China

### Test Standard Used:

FCC Rules and Regulations Part 15 Subpart C

### Test procedure used:

ANSI C63.10:2013

### We Declare:

The equipment described above is tested by Dongguan Dongdian Testing Service Co., Ltd and in the configuration tested the equipment complied with the standards specified above. The test results are contained in this test report and Dongguan Dongdian Testing Service Co., Ltd is assumed of full responsibility for the accuracy and completeness of these tests.

**After test and evaluation, our opinion is that the equipment provided for test compliance with the requirement of the above FCC standards.**

<b>Report No.:</b>	DDT-RE23081405-1E01		
<b>Date of Receipt:</b>	Aug. 24, 2023	<b>Date of Test:</b>	Aug. 24, 2023 ~ Sep. 05, 2023

**Prepared By:**

*Jacky Huang*

**Jacky Huang/Engineer**

**Approved By:**

*Damon Hu*

**Damon Hu/EMC Manager**

Note: This report applies to above tested sample only. This report shall not be reproduced in parts without written approval of Dongguan Dongdian Testing Service Co., Ltd.

### Revision History

Rev.	Revisions	Issue Date	Revised By
---	Initial issue	Sep. 08, 2023	

## 1 Summary of Test Results

Description of Test Item	Standard	Results
20 dB Bandwidth	FCC Part 15: 15.215	Pass
Radiated Emission	FCC Part 15: 15.209	Pass
Power Line Conducted Emissions	FCC Part 15: 15.207	Pass
Antenna Requirement	FCC Part 15: 15.203	Pass

## 2 General Test Information

### 2.1. Description of EUT

EUT Name	: Phone Holder
Model Number	: VPH-AC9-BK-T, VPH-AC9-WH-T, VPH-AC9-BK-D, VPH-AC9-WH-D, VPH-AC9-BK-W, VPH-AC9-WH-W
Model Difference	: It's the same except for the size, shell structure, and color of the exterior. The structure of the coil, the number of turns and the position are the same. The test model is VPH-AC9-BK-W.
EUT function description	: Please reference user manual of this device
Power Supply	: Input: 24V=4.0A Output: 5W, 7.5W, 10W
Wireless charging Operation frequency	: 110KHz-148KHz
Antenna Type	: Inductive loop coil antenna
Sample Number	: S23081405-03

Note: EUT is the abbreviation of equipment under test.

In section FCC PART 15.31(m), regards to the operating frequency range less than 1 MHz, only one of channel was selected to perform the test.

Channel	Frequency (kHz)
Testing channel	127.855

### 2.2. Accessories of EUT

Description of Accessories	Manufacturer	Model number	Description	Remark
AC DC Adapter	Shenzhenshi Zhenhuan Electronic Co., Ltd.	ZF-120a-2404000	INPUT: 100-240V~50/60Hz 2.0A, OUTPUT: 24V/4.0A	N/A

### 2.3. Assistant equipment used for test

Assistant equipment	Manufacturer	Model number	EMC Compliance	Other
Dummy Load	N/A	N/A	N/A	5W/7.5W/10W Load

### 2.4. Block diagram of EUT configuration for test

For mode 1: Tx mode:

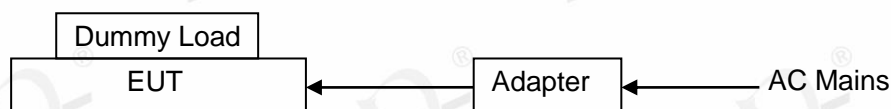

For mode 2: Standby mode:

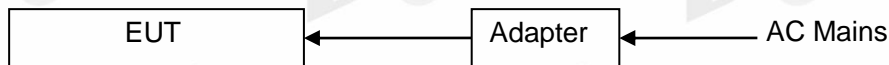

Note: Scan with mode 1 and mode 2, the worst case is mode 1 Tx mode and recorded in this report.

## 2.5. Deviations of test standard

No deviation.

## 2.6. Test environment conditions

During the measurement the environmental conditions were within the listed ranges:

Temperature range:	15-35 °C
Humidity range:	20-75%
Pressure range:	86-106 kPa

## 2.7. Test laboratory

Dongguan Dongdian Testing Service Co., Ltd

Add.: No. 17, Zongbu Road 2, Songshan Lake Sci&Tech, Industry Park, Dongguan City, Guangdong Province, China, 523808

Tel.: +86-0769-38826678, <http://www.dgddt.com>, Email: [ddt@dgddt.com](mailto:ddt@dgddt.com)

CNAS Accreditation No. L6451; A2LA Accreditation Number: 3870.01

FCC Designation Number: CN1182, Test Firm Registration Number: 540522

Innovation, Science and Economic Development Canada Site Registration Number: 10288A

Conformity Assessment Body identifier: CN0048

VCCI facility registration number: C-20087, T-20088, R-20123, G-20118



## 2.8. Measurement uncertainty

Test Item	Uncertainty
Uncertainty for Conduction emission test	3.32 dB (150 kHz - 30 MHz)
	3.72 dB (9 kHz - 150 kHz)
Uncertainty for Radiation Emission Test (9 kHz – 30 MHz)	3.44 dB
Uncertainty for Radiation Emission test (30 MHz - 1 GHz)	4.70 dB (Antenna Polarize: V)
	4.84 dB (Antenna Polarize: H)
Uncertainty for Radiation Emission test (1 GHz to 18 GHz)	4.10 dB (1-6 GHz)
	4.40 dB (6 GHz - 18 GHz)
Bandwidth	1.1%

Note: This uncertainty represents an expanded uncertainty expressed at approximately the 95% confidence level using a coverage factor of k=2.



### 3 Equipment Used During Test

Equipment	Manufacturer	Model No.	Serial No.	Last Cal.	Cal. Interval
<b>☑RF Connected Test (Tonscend RF Measurement System 3#)</b>					
Signal &Spectrum analyzer	R&S	FSV40	101407	Jun. 12, 2023	1 Year
Wideband Radio Communication tester	R&S	CMW500	117491	Apr. 27, 2023	1 Year
Vector Signal Generator	Agilent	N5182A	MY48180912	Apr. 23, 2023	1 Year
RF Control Unit	Tonscend	JS0806-2	20C8060230	Apr. 27, 2023	1 Year
Temp&Humi Programmable	ZHIXIANG	ZXGDJS-150L	ZX170110-A	May 15, 2023	1 Year
Test Software	JS Tonscend	JS1120-3	Ver.3.2.22	N/A	N/A
<b>☑Radiation 3#chamber</b>					
EMI Test Receiver	R&S	ESU26	100472	Apr. 23, 2023	1 Year
Spectrum analyzer	Agilent	E4447A	MY50180031	Apr. 23, 2023	1 Year
Active Loop antenna	Schwarzbeck	FMZB-1519	1519-038	Sep. 29, 2022	1 Year
Trilog Broadband Antenna	Schwarzbeck	VULB 9163	01429	Jul. 12, 2023	2 Year
Double Ridged Horn Antenna	Schwarzbeck	BBHA9120 D	02468	Sep. 29, 2022	1 Year
Broad Band Horn Antenna	Schwarzbeck	BBHA 9170	790	Apr. 26, 2023	1 Year
Pre-amplifier	COM-POWER	PAM-118A	18040084	Jul. 15, 2023	1 Year
Pre-amplifier	COM-POWER	PAM-840A	461369	Apr. 27, 2023	1 Year
RE Cable	N/A	W23.02 CP1-X2 + W23.09 AP1-X8+ JCT26S-NJ-NJ- 1.5M	4.5M+8M+1.5M	Apr. 21, 2023	1 Year
RF Cable	Yuhu Technology	JCTB810-NJ-N J-9M+ ZT26S-SMAJ-S MAJ-1M	21123964	Apr. 23, 2023	1 Year
Micro-Tronics filters	REBES	BRM50702	G555	N/A	N/A
Micro-Tronics filters	REBES	BRM50716	G392	N/A	N/A
High Pass filter	XB	XBLBQ-GTA67	210820-2-3	N/A	N/A
Test software	Tonscend	JS32-RE	V 5.0.0.1	N/A	N/A

<input checked="" type="checkbox"/> Power Line Conducted Emissions Test 1#					
Test Receiver	R&S	ESCI	100551	Jul. 11, 2023	1 Year
LISN 1	R&S	ENV216	101109	Jul. 11, 2023	1 Year
LISN 2	R&S	ESH2-Z5	100309	Jul. 12, 2023	1 Year
Pulse Limiter	R&S	ESH3-Z2	101242	Jul. 15, 2023	1 Year
CE Cable 1	HUBSER	N/A	W10.01	Jul. 15, 2023	1 Year
Test software	Audix <sup>®</sup>	E3	V 6.11111b	N/A	N/A

## 4 20 dB Bandwidth

### 4.1. Block diagram of test setup

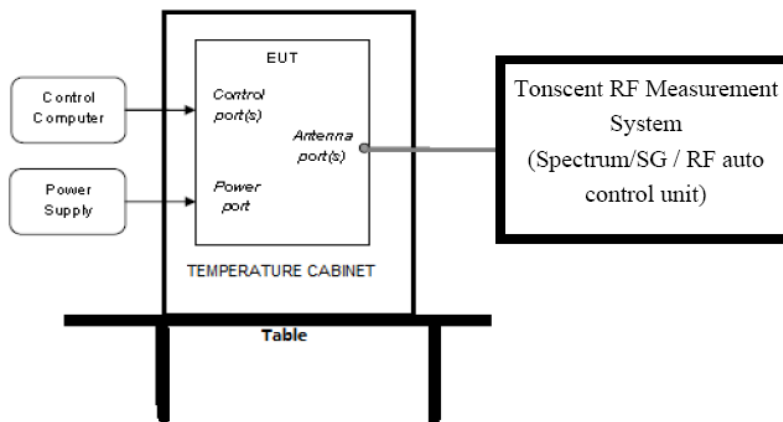

### 4.2. Limits

Intentional radiators operating under the alternative provisions to the general emission limits, as contained in § 15.217 through 15.257 and in Subpart E of this part, must be designed to ensure that the 20 dB bandwidth of the emission, or whatever bandwidth may otherwise be specified in the specific rule section under which the equipment operates, is contained within the frequency band designated in the rule section under which the equipment is operated.

### 4.3. Test procedure

(1) Connect EUT to spectrum analyzer and use the following settings:

Centre Frequency	The centre frequency of the channel under test
Detector	Peak
RBW	1% to 5% of the occupied bandwidth
VBW	Approximately 3xRBW
Trace	Max hold
Sweep	Auto

(2) The 20 dB bandwidth is defined as the total spectrum the power of which is higher than peak power minus 20 dB.

#### 4.4. Test result

Frequency (kHz)	20 dB bandwidth Result (Hz)	Conclusion
127.856	240.231	Pass

#### 4.5. Original test data

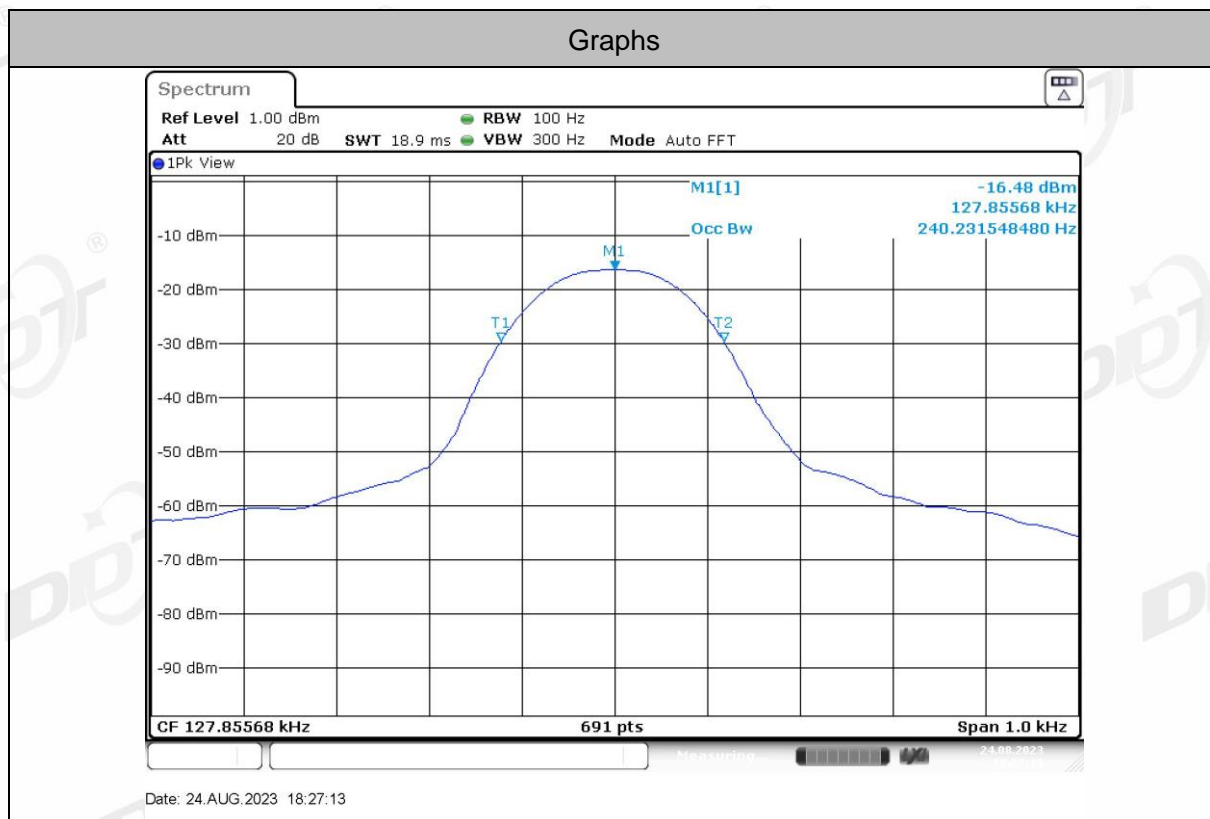

## 5 Radiated Emission

### 5.1. Block diagram of test setup

In 3 m Anechoic Chamber, test setup diagram for 9 kHz - 30 MHz:

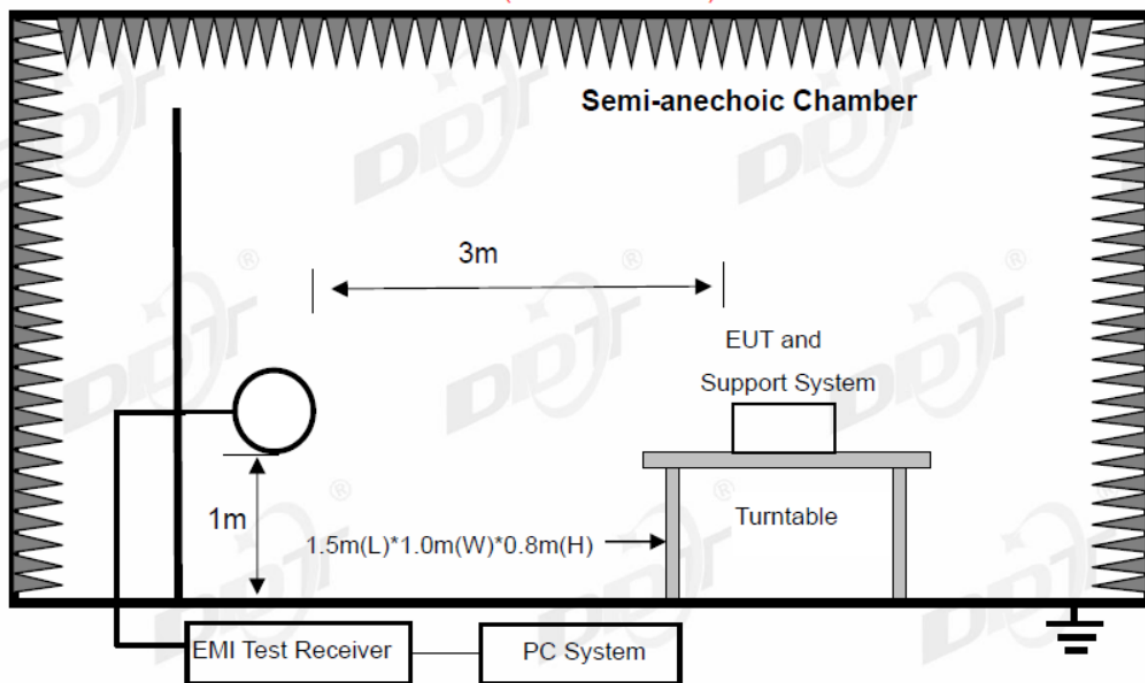

In 3 m Anechoic Chamber, test setup diagram for 30 MHz - 1 GHz:

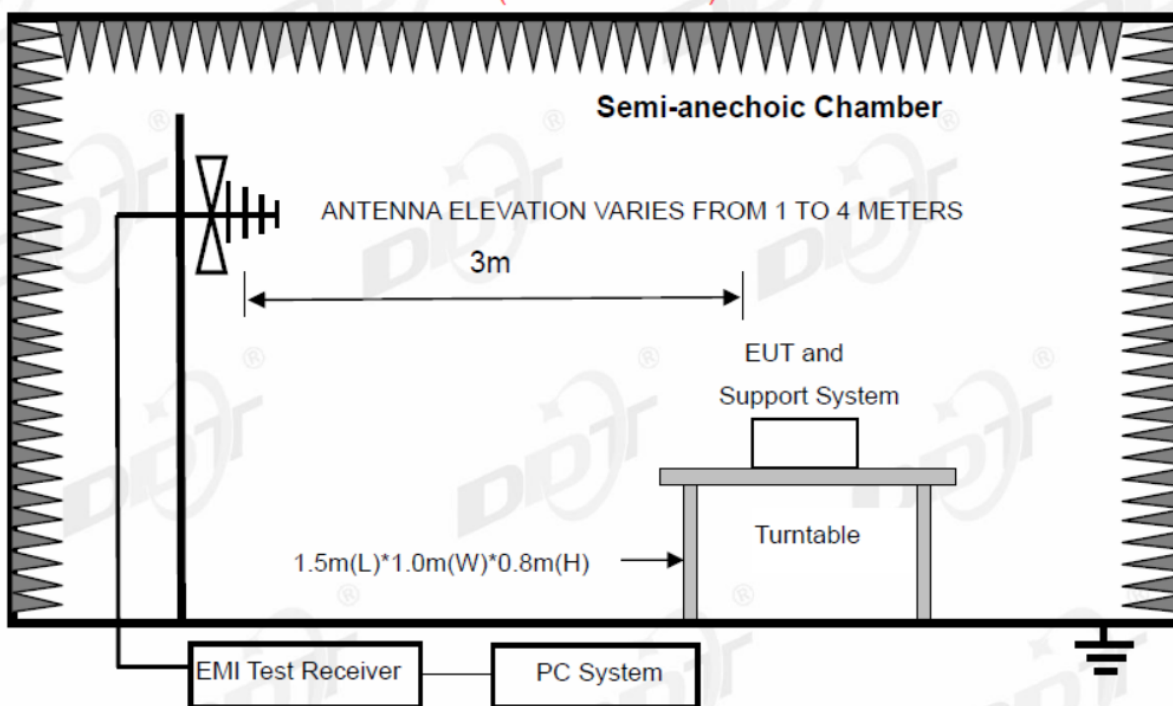



## 5.2. Limit

FREQUENCY MHz	DISTANCE Meters	FIELD STRENGTHS LIMIT	
		$\mu\text{V}/\text{m}$	$\text{dB}(\mu\text{V})/\text{m}$
0.009 ~ 0.490	300	2400/F(kHz)	67.6-20log(F)
0.490 ~ 1.705	30	24000/F(kHz)	87.6-20log(F)
1.705 ~ 30.0	30	30	29.54
30 ~ 88	3	100	40.0
88 ~ 216	3	150	43.5
216 ~ 960	3	200	46.0
960 ~ 1000	3	500	54.0

Note: (1) The emission limits shown in the above table are based on measurements employing a CISPR QP detector except for the frequency bands 9-90 kHz, 110-490 kHz and above 1000 MHz. Radiated emissions limits in these three bands are based on measurements employing an average detector.

(2) At frequencies below 30 MHz, measurement may be performed at a distance closer than that specified, and the limit at closer measurement distance can be extrapolated by below formula:

$$\text{Limit}_{3\text{m}}(\text{dBuV}/\text{m}) = \text{Limit}_{300\text{m}}(\text{dBuV}/\text{m}) + 40\text{Log}(300\text{m}/3\text{m}) = \text{Limit}_{300\text{m}}(\text{dBuV}/\text{m}) + 80$$

$$\text{Limit}_{3\text{m}}(\text{dBuV}/\text{m}) = \text{Limit}_{30\text{m}}(\text{dBuV}/\text{m}) + 40\text{Log}(30\text{m}/3\text{m}) = \text{Limit}_{30\text{m}}(\text{dBuV}/\text{m}) + 40$$

## 5.3. Test procedure

(1) EUT was placed on a non-metallic table, 80 cm above the ground plane inside a semi-anechoic chamber.

(2) Test antenna was located 3m from the EUT on an adjustable mast, and the antenna used as below table.

Test frequency range	Test antenna used	Test antenna distance
9 kHz - 30 MHz	Active Loop antenna	3 m
30 MHz - 1 GHz	Trilog Broadband Antenna	3 m

According ANSI C63.10:2013 clause 6.4.6 and 6.5.3, for measurements below 30 MHz, Antenna was located 3 m from EUT, the loop antenna was positioned in three antenna orientations (parallel, perpendicular, and round-parallel), for each measurement antenna alignment, the EUT shall be rotated through 0° to 360° on a turntable, and the lowest height of the magnetic antenna shall be 1 m above the ground. For measurement above 30 MHz, the Trilog Broadband Antenna or Horn Antenna was located 3 m from EUT, Measurements were made with the antenna positioned in both the horizontal and vertical planes of Polarization, and the measurement antenna was varied from 1 m to 4 m. in height above the reference ground plane to obtain the maximum signal strength.

(3) Below pre-scan procedure was first performed in order to find prominent frequency spectrum radiated emissions from 9 kHz to 1 GHz:

(a) Scanning the peak frequency spectrum with the antenna specified in step (3), and the EUT was rotated 360 degree, the antenna height was varied from 1 m to 4 m (Except loop antenna, it's

fixed 1 m above ground) .

(b) Change work frequency or channel of device if practicable.

(c) Change modulation type of device if practicable.

(d) Rotated EUT though three orthogonal axes to determine the attitude of EUT arrangement produce highest emissions. Spectrum frequency from 9 kHz to 1 GHz (tenth harmonic of fundamental frequency) was investigated.

(4) For final emissions measurements at each frequency of interest, the EUT was rotated and the antenna height was varied between 1 m and 4 m in order to maximize the emission.

Measurements in both horizontal and vertical polarities were made and the data was recorded. In order to find the maximum emission, the relative positions of equipments and all of the interface cables were changed according to ANSI C63.10:2013 on Radiated Emission test.

(5) The emissions from 9 kHz to 1 GHz were measured based on CISPR QP detector except for the frequency bands 9-90 kHz, 110-490 kHz, for emissions from 9 kHz - 90 kHz, 110 kHz - 490 kHz and above 1 GHz were measured based on average detector.

(6) The emissions from 9 kHz to 1 GHz, QP or average values were measured with EMI receiver with below RBW.

Frequency band	RBW
9 kHz - 150 kHz	200 Hz
150 kHz - 30 MHz	9 kHz
30 MHz - 1 GHz	120 kHz

#### 5.4. Test result

**Pass. (See below detailed test result)**

Note: For emission above 30MHz, only record the worst case: 10W Load.



Below 30 MHz:

# TR-4-E-009 Radiated Emission Test Result

**Test Date:** 2023-08-26      **Tested By:** Johnson Huang  
**EUT:** Phone Holder      **Model Number:** VPH-AC9-BK-W  
**Test Mode:** TX Mode      **Power Supply:** 120V/60Hz  
**Condition:** Temp:22.5°C;Humi:64.5%      **Test Site:** DDT 3# Chamber  
**File Path:** d:\ts\2023 report data\Q23081405 VPH-AC9-BK-W\FCC BELOW 1G  
 9K-30M\20230826-225930\_V  
**Memo:** 5W X

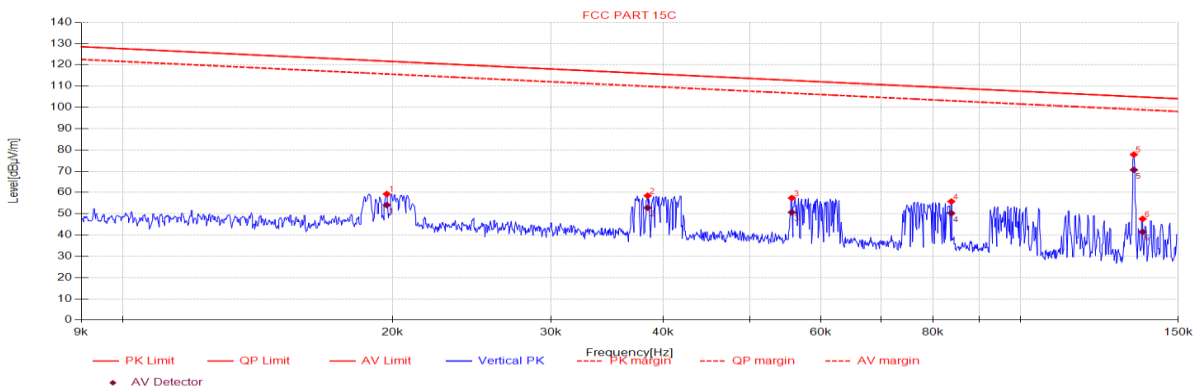

Suspected Data List										
NO.	Freq. [MHz]	Reading [dBµV/m]	Antenna Factor [dB]	Cable loss [dB]	AMP [dB]	Level [dBµV/m]	Limit [dBµV/m]	Margin [dB]	Detector	Polarity
1	0.02	68.73	19.80	0.07	-29.32	59.28	121.71	62.43	PK	X
2	0.04	68.02	19.74	0.07	-29.35	58.48	115.90	57.42	PK	X
3	0.06	66.89	19.82	0.07	-29.38	57.40	112.69	55.29	PK	X
4	0.08	65.23	19.90	0.07	-29.43	55.77	109.13	53.36	PK	X
5	0.13	87.43	19.83	0.07	-29.51	77.82	105.07	27.25	PK	X
6	0.14	57.21	19.83	0.07	-29.52	47.59	104.87	57.28	PK	X

Final Data List										
NO.	Freq. [MHz]	Reading [dBµV/m]	Antenna Factor [dB]	Cable loss [dB]	AMP [dB]	Level [dBµV/m]	Limit [dBµV/m]	Margin [dB]	Detector	Polarity
1	0.02	63.54	19.80	0.07	-29.32	54.09	121.71	67.62	AV	X
2	0.04	62.35	19.74	0.07	-29.35	52.81	115.89	63.08	AV	X
3	0.06	60.14	19.82	0.07	-29.38	50.65	112.68	62.03	AV	X
4	0.08	59.68	19.90	0.07	-29.43	50.22	109.14	58.92	AV	X
5	0.13	80.23	19.83	0.07	-29.51	70.62	105.07	34.45	AV	X
6	0.14	51.06	19.83	0.07	-29.52	41.44	104.87	63.43	AV	X

Note:

- Level = Reading + Cable Loss + Antenna Factor + AMP
- If Peak Result complies with QP limit, QP Result is deemed to comply with QP limit.
- Test setup: 9kHz-150kHz RBW: 300Hz, VBW: 1 kHz, Sweep time: auto.  
150kHz-30MHz RBW: 10kHz, VBW: 30kHz, Sweep time: auto.

## TR-4-E-009 Radiated Emission Test Result

<b>Test Date:</b>	2023-08-26	<b>Tested By:</b>	Johnson Huang
<b>EUT:</b>	Phone Holder	<b>Model Number:</b>	VPH-AC9-BK-W
<b>Test Mode:</b>	TX Mode	<b>Power Supply:</b>	120V/60Hz
<b>Condition:</b>	Temp:22.5°C;Humi:64.5%	<b>Test Site:</b>	DDT 3# Chamber
<b>File Path:</b>	d:\ts\2023 report data\Q23081405 VPH-AC9-BK-W\FCC BELOW 1G 9K-30M\20230826-230300_V		
<b>Memo:</b>	5W Y		

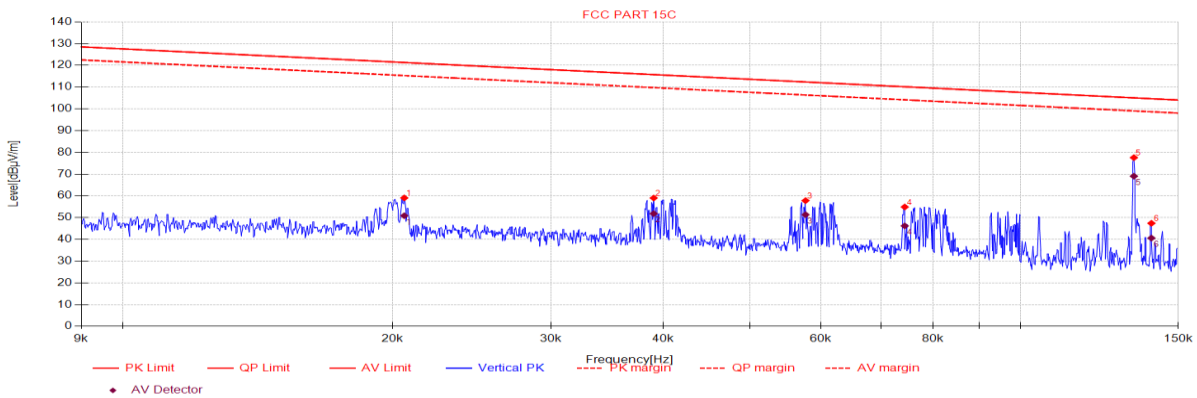

Suspected Data List										
NO.	Freq. [MHz]	Reading [dBμV/m]	Antenna Factor [dB]	Cable loss [dB]	AMP [dB]	Level [dBμV/m]	Limit [dBμV/m]	Margin [dB]	Detector	Polarity
1	0.02	68.52	19.79	0.07	-29.32	59.06	121.32	62.26	PK	Y
2	0.04	68.54	19.75	0.07	-29.35	59.01	115.76	56.75	PK	Y
3	0.06	67.28	19.83	0.07	-29.38	57.80	112.38	54.58	PK	Y
4	0.07	64.34	19.90	0.07	-29.41	54.90	110.17	55.27	PK	Y
5	0.13	87.20	19.83	0.07	-29.51	77.59	105.07	27.48	PK	Y
6	0.14	57.04	19.82	0.07	-29.53	47.40	104.68	57.28	PK	Y

Final Data List										
NO.	Freq. [MHz]	Reading [dBμV/m]	Antenna Factor [dB]	Cable loss [dB]	AMP [dB]	Level [dBμV/m]	Limit [dBμV/m]	Margin [dB]	Detector	Polarity
1	0.02	60.32	19.79	0.07	-29.32	50.86	121.32	70.46	AV	Y
2	0.04	61.35	19.75	0.07	-29.35	51.82	115.75	63.93	AV	Y
3	0.06	60.82	19.83	0.07	-29.38	51.34	112.38	61.04	AV	Y
4	0.07	55.62	19.90	0.07	-29.41	46.18	110.17	63.99	AV	Y
5	0.13	78.65	19.83	0.07	-29.51	69.04	105.07	36.03	AV	Y
6	0.14	50.24	19.82	0.07	-29.53	40.60	104.68	64.08	AV	Y

Note:

1. Level = Reading + Cable Loss + Antenna Factor + AMP
2. If Peak Result complies with QP limit, QP Result is deemed to comply with QP limit.
3. Test setup: 9kHz-150kHz RBW: 300Hz, VBW: 1 kHz, Sweep time: auto.  
150kHz-30MHz RBW: 10kHz, VBW: 30kHz, Sweep time: auto.

## TR-4-E-009 Radiated Emission Test Result

<b>Test Date:</b>	2023-08-26	<b>Tested By:</b>	Johnson Huang
<b>EUT:</b>	Phone Holder	<b>Model Number:</b>	VPH-AC9-BK-W
<b>Test Mode:</b>	TX Mode	<b>Power Supply:</b>	120V/60Hz
<b>Condition:</b>	Temp:22.5°C;Humi:64.5%	<b>Test Site:</b>	DDT 3# Chamber
<b>File Path:</b>	d:\ts\2023 report data\Q23081405 VPH-AC9-BK-W\FCC BELOW 1G 9K-30M\20230826-230347_V		
<b>Memo:</b>	5W Z		

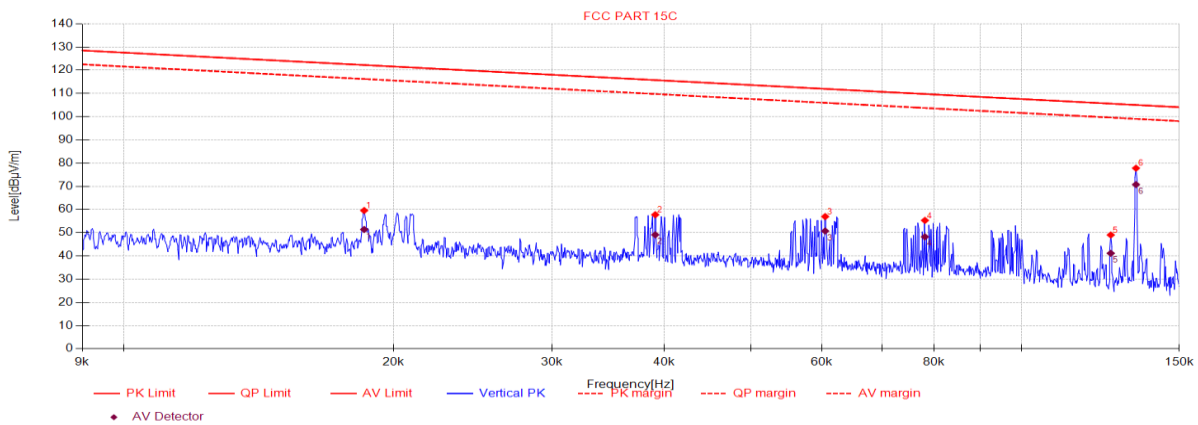

Suspected Data List										
NO.	Freq. [MHz]	Reading [dBµV/m]	Antenna Factor [dB]	Cable loss [dB]	AMP [dB]	Level [dBµV/m]	Limit [dBµV/m]	Margin [dB]	Detector	Polarity
1	0.02	69.02	19.81	0.07	-29.32	59.58	122.23	62.65	PK	Z
2	0.04	67.28	19.75	0.07	-29.35	57.75	115.75	58.00	PK	Z
3	0.06	66.45	19.84	0.07	-29.39	56.97	111.97	55.00	PK	Z
4	0.08	64.76	19.90	0.07	-29.42	55.31	109.74	54.43	PK	Z
5	0.13	58.61	19.85	0.07	-29.50	49.03	105.61	56.58	PK	Z
6	0.13	87.43	19.83	0.07	-29.52	77.81	105.04	27.23	PK	Z

Final Data List										
NO.	Freq. [MHz]	Reading [dBµV/m]	Antenna Factor [dB]	Cable loss [dB]	AMP [dB]	Level [dBµV/m]	Limit [dBµV/m]	Margin [dB]	Detector	Polarity
1	0.02	60.84	19.82	0.07	-29.32	51.41	122.25	70.84	AV	Z
2	0.04	58.65	19.75	0.07	-29.35	49.12	115.75	66.63	AV	Z
3	0.06	60.21	19.84	0.07	-29.39	50.73	111.96	61.23	AV	Z
4	0.08	57.69	19.90	0.07	-29.42	48.24	109.75	61.51	AV	Z
5	0.13	50.72	19.85	0.07	-29.50	41.14	105.61	64.47	AV	Z
6	0.13	80.36	19.83	0.07	-29.52	70.74	105.05	34.31	AV	Z

Note:

1. Level = Reading + Cable Loss + Antenna Factor + AMP
2. If Peak Result complies with QP limit, QP Result is deemed to comply with QP limit.
3. Test setup: 9kHz-150kHz RBW: 300Hz, VBW: 1 kHz, Sweep time: auto.  
150kHz-30MHz RBW: 10kHz, VBW: 30kHz, Sweep time: auto.

# TR-4-E-009 Radiated Emission Test Result

**Test Date:** 2023-08-26 **Tested By:** Johnson Huang  
**EUT:** Phone Holder **Model Number:** VPH-AC9-BK-W  
**Test Mode:** TX Mode **Power Supply:** 120V/60Hz  
**Condition:** Temp:22.5°C;Humi:64.5% **Test Site:** DDT 3# Chamber  
**File Path:** d:\ts\2023 report data\Q23081405 VPH-AC9-BK-W\FCC BELOW 1G  
 9K-30M\20230826-230509\_V  
**Memo:** 5W X

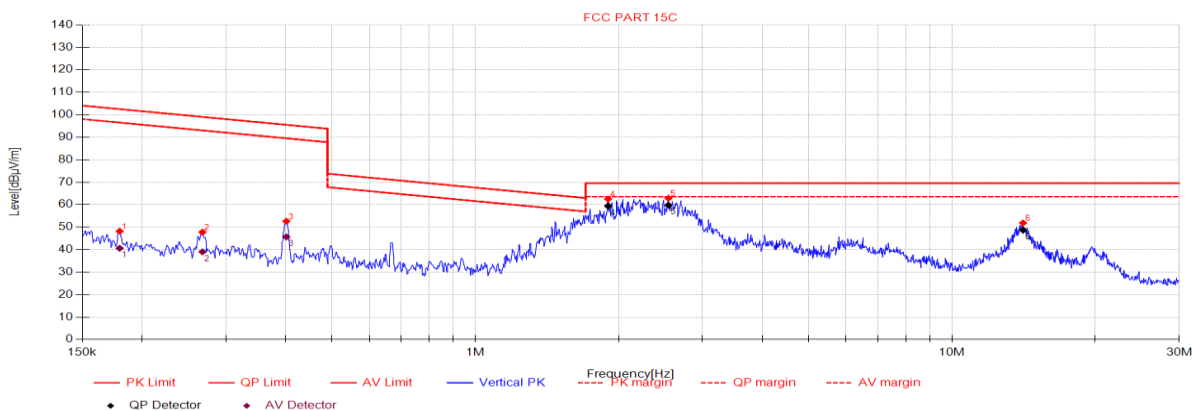

Suspected Data List										
NO.	Freq. [MHz]	Reading [dBμV/m]	Antenna Factor [dB]	Cable loss [dB]	AMP [dB]	Level [dBμV/m]	Limit [dBμV/m]	Margin [dB]	Detector	Polarity
1	0.18	57.97	19.77	0.07	-29.59	48.22	102.52	54.30	PK	X
2	0.27	57.75	19.71	0.08	-29.74	47.80	99.04	51.24	PK	X
3	0.40	62.85	19.76	0.08	-30.05	52.64	95.53	42.89	PK	X
4	1.90	73.87	20.02	0.13	-31.48	62.54	69.54	7.00	PK	X
5	2.54	74.45	19.78	0.13	-31.47	62.89	69.54	6.65	PK	X
6	14.11	62.89	19.94	0.28	-31.24	51.87	69.54	17.67	PK	X

Final Data List										
NO.	Freq. [MHz]	Reading [dBμV/m]	Antenna Factor [dB]	Cable loss [dB]	AMP [dB]	Level [dBμV/m]	Limit [dBμV/m]	Margin [dB]	Detector	Polarity
1	0.18	50.36	19.77	0.07	-29.59	40.61	102.52	61.91	AV	X
2	0.27	48.98	19.71	0.08	-29.74	39.03	99.04	60.01	AV	X
3	0.40	55.89	19.76	0.08	-30.05	45.68	95.53	49.85	AV	X
4	1.90	70.75	20.02	0.13	-31.48	59.42	69.54	10.12	QP	X
5	2.54	71.33	19.78	0.13	-31.47	59.77	69.54	9.77	QP	X
6	14.11	59.77	19.94	0.28	-31.24	48.75	69.54	20.79	QP	X

Note:

- Level = Reading + Cable Loss + Antenna Factor + AMP
- If Peak Result complies with QP limit, QP Result is deemed to comply with QP limit.
- Test setup: 9kHz-150kHz RBW: 300Hz, VBW: 1 kHz, Sweep time: auto.  
 150kHz-30MHz RBW: 10kHz, VBW: 30kHz, Sweep time: auto.

# TR-4-E-009 Radiated Emission Test Result

**Test Date:** 2023-08-26 **Tested By:** Johnson Huang  
**EUT:** Phone Holder **Model Number:** VPH-AC9-BK-W  
**Test Mode:** TX Mode **Power Supply:** 120V/60Hz  
**Condition:** Temp:22.5°C;Humi:64.5% **Test Site:** DDT 3# Chamber  
**File Path:** d:\ts\2023 report data\Q23081405 VPH-AC9-BK-W\FCC BELOW 1G 9K-30M\20230826-230555\_V  
**Memo:** 5W Y

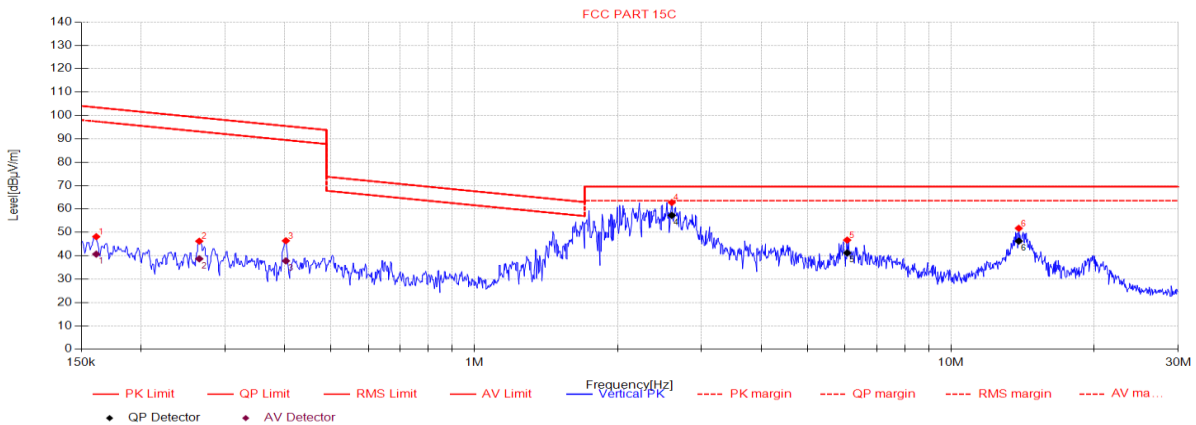

Suspected Data List										
NO.	Freq. [MHz]	Reading [dBµV/m]	Antenna Factor [dB]	Cable loss [dB]	AMP [dB]	Level [dBµV/m]	Limit [dBµV/m]	Margin [dB]	Detector	Polarity
1	0.16	57.85	19.79	0.07	-29.56	48.15	103.46	55.31	PK	Y
2	0.27	56.18	19.71	0.08	-29.74	46.23	99.14	52.91	PK	Y
3	0.40	56.62	19.76	0.08	-30.05	46.41	95.50	49.09	PK	Y
4	2.60	74.34	19.76	0.13	-31.46	62.77	69.54	6.77	PK	Y
5	6.06	57.74	20.18	0.16	-31.39	46.69	69.54	22.85	PK	Y
6	13.88	62.77	19.94	0.28	-31.24	51.75	69.54	17.79	PK	Y

Final Data List										
NO.	Freq. [MHz]	Reading [dBµV/m]	Antenna Factor [dB]	Cable loss [dB]	AMP [dB]	Level [dBµV/m]	Limit [dBµV/m]	Margin [dB]	Detector	Polarity
1	0.16	50.36	19.79	0.07	-29.56	40.66	103.46	62.80	AV	Y
2	0.27	48.63	19.71	0.08	-29.74	38.68	99.13	60.45	AV	Y
3	0.40	47.99	19.76	0.08	-30.05	37.78	95.50	57.72	AV	Y
4	2.60	68.84	19.76	0.13	-31.46	57.27	69.54	12.27	QP	Y
5	6.06	52.24	20.18	0.16	-31.39	41.19	69.54	28.35	QP	Y
6	13.88	57.27	19.94	0.28	-31.24	46.25	69.54	23.29	QP	Y

Note:

- Level = Reading + Cable Loss + Antenna Factor + AMP
- If Peak Result complies with QP limit, QP Result is deemed to comply with QP limit.
- Test setup: 9kHz-150kHz RBW: 300Hz, VBW: 1 kHz, Sweep time: auto.  
150kHz-30MHz RBW: 10kHz, VBW: 30kHz, Sweep time: auto.





## TR-4-E-009 Radiated Emission Test Result

**Test Date:** 2023-08-26 **Tested By:** Johnson Huang  
**EUT:** Phone Holder **Model Number:** VPH-AC9-BK-W  
**Test Mode:** TX Mode **Power Supply:** 120V/60Hz  
**Condition:** Temp:22.5°C;Humi:64.5% **Test Site:** DDT 3# Chamber  
**File Path:** d:\ts\2023 report data\Q23081405 VPH-AC9-BK-W\FCC BELOW 1G  
 9K-30M\20230826-230850\_V  
**Memo:** 7.5W X

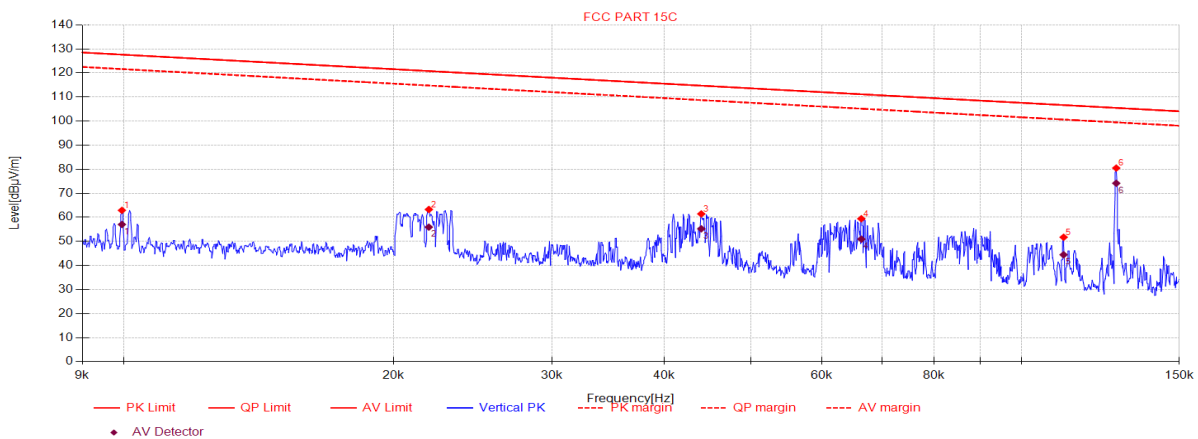

### Suspected Data List

NO.	Freq. [MHz]	Reading [dBµV/m]	Antenna Factor [dB]	Cable loss [dB]	AMP [dB]	Level [dBµV/m]	Limit [dBµV/m]	Margin [dB]	Detector	Polarity
1	0.01	72.23	19.90	0.07	-29.30	62.90	127.63	64.73	PK	X
2	0.02	72.74	19.78	0.07	-29.32	63.27	120.79	57.52	PK	X
3	0.04	70.94	19.77	0.07	-29.36	61.42	114.73	53.31	PK	X
4	0.07	68.88	19.87	0.07	-29.40	59.42	111.16	51.74	PK	X
5	0.11	61.25	19.88	0.07	-29.48	51.72	106.66	54.94	PK	X
6	0.13	90.07	19.84	0.07	-29.50	80.48	105.48	25.00	PK	X

### Final Data List

NO.	Freq. [MHz]	Reading [dBµV/m]	Antenna Factor [dB]	Cable loss [dB]	AMP [dB]	Level [dBµV/m]	Limit [dBµV/m]	Margin [dB]	Detector	Polarity
1	0.01	66.36	19.90	0.07	-29.30	57.03	127.60	70.57	AV	X
2	0.02	65.39	19.78	0.07	-29.32	55.92	120.79	64.87	AV	X
3	0.04	64.75	19.77	0.07	-29.36	55.23	114.73	59.50	AV	X
4	0.07	60.39	19.87	0.07	-29.40	50.93	111.16	60.23	AV	X
5	0.11	53.97	19.88	0.07	-29.48	44.44	106.66	62.22	AV	X
6	0.13	83.74	19.84	0.07	-29.50	74.15	105.48	31.33	AV	X

Note:

- Level = Reading + Cable Loss + Antenna Factor + AMP
- If Peak Result complies with QP limit, QP Result is deemed to comply with QP limit.
- Test setup: 9kHz-150kHz RBW: 300Hz, VBW: 1 kHz, Sweep time: auto.  
150kHz-30MHz RBW: 10kHz, VBW: 30kHz, Sweep time: auto.



# TR-4-E-009 Radiated Emission Test Result

**Test Date:** 2023-08-26      **Tested By:** Johnson Huang  
**EUT:** Phone Holder      **Model Number:** VPH-AC9-BK-W  
**Test Mode:** TX Mode      **Power Supply:** 120V/60Hz  
**Condition:** Temp:22.5°C;Humi:64.5%      **Test Site:** DDT 3# Chamber  
**File Path:** d:\ts\2023 report data\Q23081405 VPH-AC9-BK-W\FCC BELOW 1G  
 9K-30M\20230826-230958\_V  
**Memo:** 7.5W Y

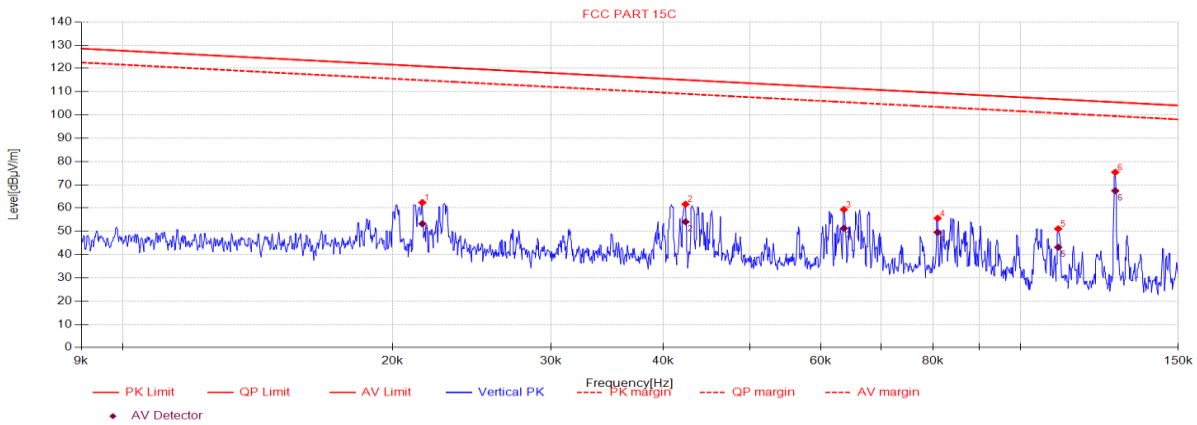

Suspected Data List										
NO.	Freq. [MHz]	Reading [dBµV/m]	Antenna Factor [dB]	Cable loss [dB]	AMP [dB]	Level [dBµV/m]	Limit [dBµV/m]	Margin [dB]	Detector	Polarity
1	0.02	71.83	19.78	0.07	-29.32	62.36	120.92	58.56	PK	Y
2	0.04	71.16	19.76	0.07	-29.36	61.63	115.06	53.43	PK	Y
3	0.06	68.83	19.85	0.07	-29.39	59.36	111.53	52.17	PK	Y
4	0.08	65.06	19.90	0.07	-29.42	55.61	109.44	53.83	PK	Y
5	0.11	60.57	19.88	0.07	-29.47	51.05	106.75	55.70	PK	Y
6	0.13	84.94	19.84	0.07	-29.50	75.35	105.48	30.13	PK	Y

Final Data List										
NO.	Freq. [MHz]	Reading [dBµV/m]	Antenna Factor [dB]	Cable loss [dB]	AMP [dB]	Level [dBµV/m]	Limit [dBµV/m]	Margin [dB]	Detector	Polarity
1	0.02	62.69	19.78	0.07	-29.32	53.22	120.91	67.69	AV	Y
2	0.04	63.58	19.76	0.07	-29.36	54.05	115.05	61.00	AV	Y
3	0.06	60.74	19.85	0.07	-29.39	51.27	111.53	60.26	AV	Y
4	0.08	58.99	19.90	0.07	-29.42	49.54	109.44	59.90	AV	Y
5	0.11	52.66	19.88	0.07	-29.47	43.14	106.76	63.62	AV	Y
6	0.13	76.98	19.84	0.07	-29.50	67.39	105.48	38.09	AV	Y

Note:

- Level = Reading + Cable Loss + Antenna Factor + AMP
- If Peak Result complies with QP limit, QP Result is deemed to comply with QP limit.
- Test setup: 9kHz-150kHz RBW: 300Hz, VBW: 1 kHz, Sweep time: auto.  
150kHz-30MHz RBW: 10kHz, VBW: 30kHz, Sweep time: auto.

# TR-4-E-009 Radiated Emission Test Result

**Test Date:** 2023-08-26      **Tested By:** Johnson Huang  
**EUT:** Phone Holder      **Model Number:** VPH-AC9-BK-W  
**Test Mode:** TX Mode      **Power Supply:** 120V/60Hz  
**Condition:** Temp:22.5°C;Humi:64.5%      **Test Site:** DDT 3# Chamber  
**File Path:** d:\ts\2023 report data\Q23081405 VPH-AC9-BK-W\FCC BELOW 1G  
                   9K-30M\20230826-231033\_V  
**Memo:** 7.5W Z

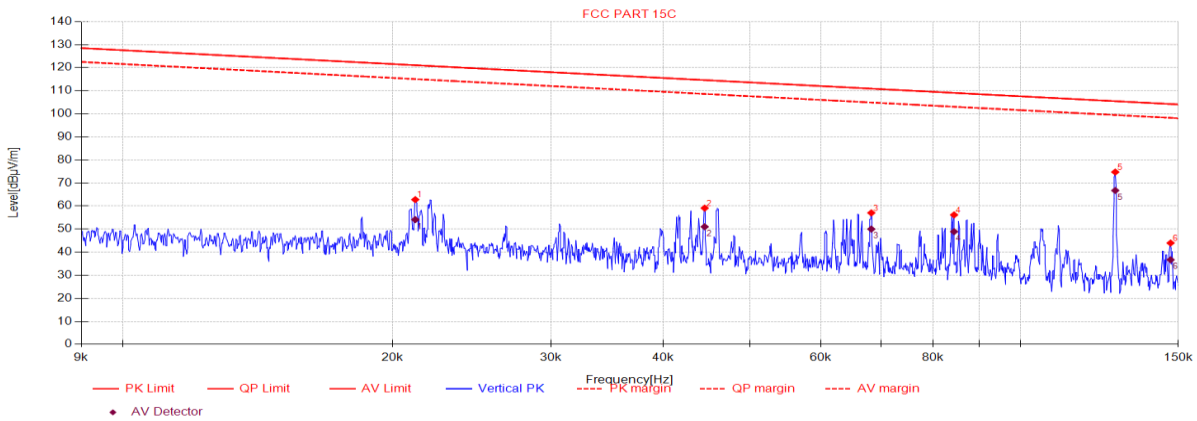

Suspected Data List										
NO.	Freq. [MHz]	Reading [dBµV/m]	Antenna Factor [dB]	Cable loss [dB]	AMP [dB]	Level [dBµV/m]	Limit [dBµV/m]	Margin [dB]	Detector	Polarity
1	0.02	72.25	19.79	0.07	-29.32	62.79	121.07	58.28	PK	Z
2	0.04	68.63	19.77	0.07	-29.36	59.11	114.63	55.52	PK	Z
3	0.07	66.49	19.87	0.07	-29.40	57.03	110.92	53.89	PK	Z
4	0.08	65.62	19.90	0.07	-29.43	56.16	109.07	52.91	PK	Z
5	0.13	84.34	19.84	0.07	-29.50	74.75	105.48	30.73	PK	Z
6	0.15	53.63	19.81	0.07	-29.54	43.97	104.25	60.28	PK	Z

Final Data List										
NO.	Freq. [MHz]	Reading [dBµV/m]	Antenna Factor [dB]	Cable loss [dB]	AMP [dB]	Level [dBµV/m]	Limit [dBµV/m]	Margin [dB]	Detector	Polarity
1	0.02	63.56	19.79	0.07	-29.32	54.10	121.07	66.97	AV	Z
2	0.04	60.54	19.77	0.07	-29.36	51.02	114.63	63.61	AV	Z
3	0.07	59.47	19.87	0.07	-29.40	50.01	110.91	60.90	AV	Z
4	0.08	58.36	19.90	0.07	-29.43	48.90	109.07	60.17	AV	Z
5	0.13	76.33	19.84	0.07	-29.50	66.74	105.48	38.74	AV	Z
6	0.15	46.36	19.81	0.07	-29.54	36.70	104.25	67.55	AV	Z

Note:

- Level = Reading + Cable Loss + Antenna Factor + AMP
- If Peak Result complies with QP limit, QP Result is deemed to comply with QP limit.
- Test setup: 9kHz-150kHz RBW: 300Hz, VBW: 1 kHz, Sweep time: auto.  
 150kHz-30MHz RBW: 10kHz, VBW: 30kHz, Sweep time: auto.

## TR-4-E-009 Radiated Emission Test Result

**Test Date:** 2023-08-26      **Tested By:** Johnson Huang  
**EUT:** Phone Holder      **Model Number:** VPH-AC9-BK-W  
**Test Mode:** TX Mode      **Power Supply:** 120V/60Hz  
**Condition:** Temp:22.5°C;Humi:64.5%      **Test Site:** DDT 3# Chamber  
**File Path:** d:\ts\2023 report data\Q23081405 VPH-AC9-BK-W\FCC BELOW 1G  
 9K-30M\20230826-231142\_V  
**Memo:** 7.5W X

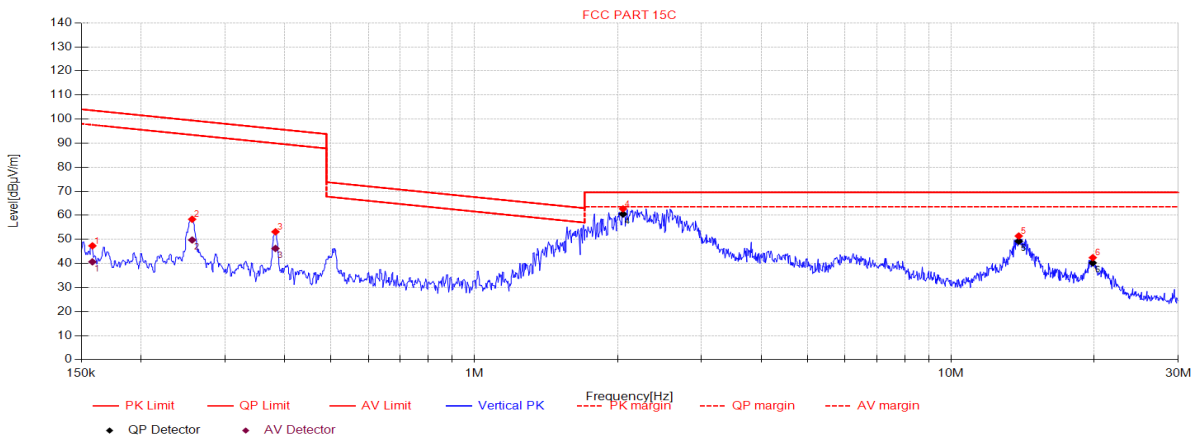

Suspected Data List										
NO.	Freq. [MHz]	Reading [dBµV/m]	Antenna Factor [dB]	Cable loss [dB]	AMP [dB]	Level [dBµV/m]	Limit [dBµV/m]	Margin [dB]	Detector	Polarity
1	0.16	57.02	19.79	0.07	-29.56	47.32	103.62	56.30	PK	X
2	0.26	68.30	19.70	0.08	-29.72	58.36	99.43	41.07	PK	X
3	0.38	63.33	19.75	0.08	-30.00	53.16	95.94	42.78	PK	X
4	2.05	74.06	19.98	0.13	-31.48	62.69	69.54	6.85	PK	X
5	13.88	62.42	19.94	0.28	-31.24	51.40	69.54	18.14	PK	X
6	19.85	52.96	20.19	0.40	-31.15	42.40	69.54	27.14	PK	X

Final Data List										
NO.	Freq. [MHz]	Reading [dBµV/m]	Antenna Factor [dB]	Cable loss [dB]	AMP [dB]	Level [dBµV/m]	Limit [dBµV/m]	Margin [dB]	Detector	Polarity
1	0.16	50.36	19.79	0.07	-29.56	40.66	103.62	62.96	AV	X
2	0.26	59.68	19.70	0.08	-29.72	49.74	99.43	49.69	AV	X
3	0.38	56.39	19.75	0.08	-30.00	46.22	95.94	49.72	AV	X
4	2.05	71.9	19.98	0.13	-31.48	60.53	69.54	9.01	QP	X
5	13.88	60.26	19.94	0.28	-31.24	49.24	69.54	20.30	QP	X
6	19.85	50.8	20.19	0.40	-31.15	40.24	69.54	29.30	QP	X

Note:

1. Level = Reading + Cable Loss + Antenna Factor + AMP
2. If Peak Result complies with QP limit, QP Result is deemed to comply with QP limit.
3. Test setup: 9kHz-150kHz RBW: 300Hz, VBW: 1 kHz, Sweep time: auto.  
150kHz-30MHz RBW: 10kHz, VBW: 30kHz, Sweep time: auto.

# TR-4-E-009 Radiated Emission Test Result

**Test Date:** 2023-08-26 **Tested By:** Johnson Huang  
**EUT:** Phone Holder **Model Number:** VPH-AC9-BK-W  
**Test Mode:** TX Mode **Power Supply:** 120V/60Hz  
**Condition:** Temp:22.5°C;Humi:64.5% **Test Site:** DDT 3# Chamber  
**File Path:** d:\ts\2023 report data\Q23081405 VPH-AC9-BK-W\FCC BELOW 1G  
9K-30M\20230826-231210\_V  
**Memo:** 7.5W Y

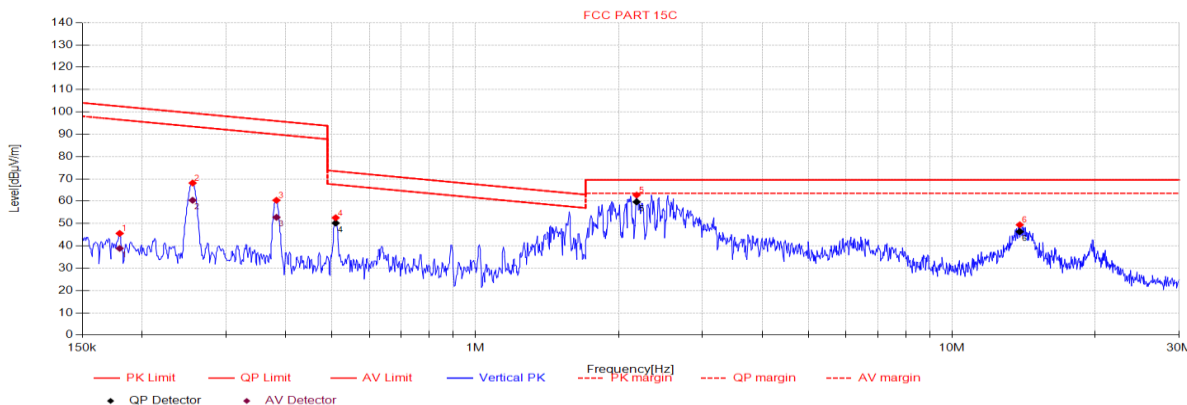

NO.	Freq. [MHz]	Reading [dBµV/m]	Antenna Factor [dB]	Cable loss [dB]	AMP [dB]	Level [dBµV/m]	Limit [dBµV/m]	Margin [dB]	Detector	Polarity
1	0.18	55.33	19.77	0.07	-29.59	45.58	102.52	56.94	PK	Y
2	0.26	78.10	19.70	0.08	-29.72	68.16	99.46	31.30	PK	Y
3	0.38	70.59	19.75	0.08	-30.00	60.42	95.94	35.52	PK	Y
4	0.51	63.04	19.80	0.08	-30.31	52.61	73.46	20.85	PK	Y
5	2.18	74.18	19.93	0.13	-31.47	62.77	69.54	6.77	PK	Y
6	13.88	60.45	19.94	0.28	-31.24	49.43	69.54	20.11	PK	Y

NO.	Freq. [MHz]	Reading [dBµV/m]	Antenna Factor [dB]	Cable loss [dB]	AMP [dB]	Level [dBµV/m]	Limit [dBµV/m]	Margin [dB]	Detector	Polarity
1	0.18	48.62	19.77	0.07	-29.59	38.87	102.52	63.65	AV	Y
2	0.26	70.36	19.70	0.08	-29.72	60.42	99.46	39.04	AV	Y
3	0.38	62.96	19.75	0.08	-30.00	52.79	95.94	43.15	AV	Y
4	0.51	60.63	19.80	0.08	-30.31	50.20	73.46	23.26	QP	Y
5	2.18	71.12	19.93	0.13	-31.47	59.71	69.54	9.83	QP	Y
6	13.88	57.39	19.94	0.28	-31.24	46.37	69.54	23.17	QP	Y

Note:

- Level = Reading + Cable Loss + Antenna Factor + AMP
- If Peak Result complies with QP limit, QP Result is deemed to comply with QP limit.
- Test setup: 9kHz-150kHz RBW: 300Hz, VBW: 1 kHz, Sweep time: auto.  
150kHz-30MHz RBW: 10kHz, VBW: 30kHz, Sweep time: auto.

# TR-4-E-009 Radiated Emission Test Result

**Test Date:** 2023-08-26 **Tested By:** Johnson Huang  
**EUT:** Phone Holder **Model Number:** VPH-AC9-BK-W  
**Test Mode:** TX Mode **Power Supply:** 120V/60Hz  
**Condition:** Temp:22.5°C;Humi:64.5% **Test Site:** DDT 3# Chamber  
**File Path:** d:\ts\2023 report data\Q23081405 VPH-AC9-BK-WFCC BELOW 1G  
 9K-30M\20230826-231223\_V  
**Memo:** 7.5W Z

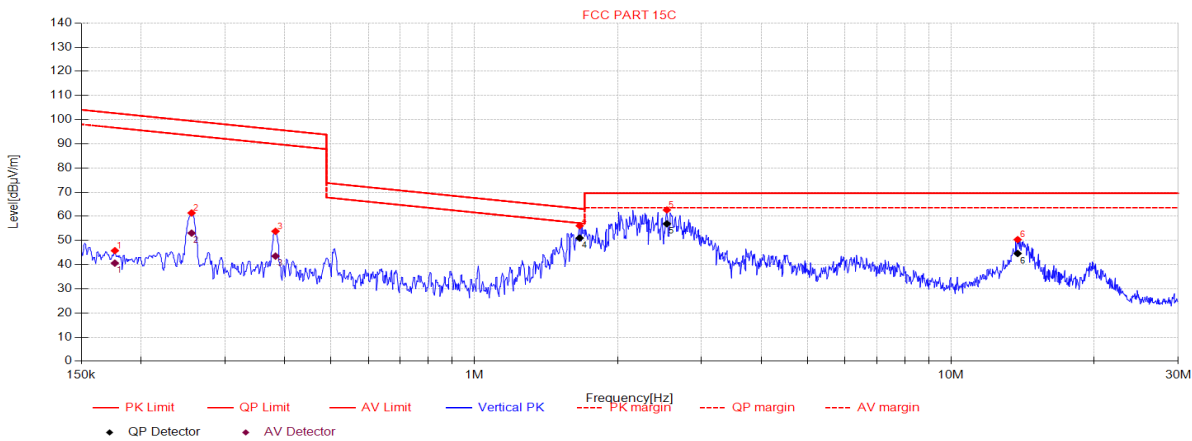

Suspected Data List										
NO.	Freq. [MHz]	Reading [dBµV/m]	Antenna Factor [dB]	Cable loss [dB]	AMP [dB]	Level [dBµV/m]	Limit [dBµV/m]	Margin [dB]	Detector	Polarity
1	0.18	55.52	19.77	0.07	-29.59	45.77	102.68	56.91	PK	Z
2	0.26	71.32	19.70	0.08	-29.72	61.38	99.46	38.08	PK	Z
3	0.38	63.95	19.75	0.08	-30.00	53.78	95.94	42.16	PK	Z
4	1.66	67.36	20.07	0.13	-31.49	56.07	63.18	7.11	PK	Z
5	2.54	74.18	19.79	0.13	-31.47	62.63	69.54	6.91	PK	Z
6	13.81	61.35	19.95	0.28	-31.24	50.34	69.54	19.20	PK	Z

Final Data List										
NO.	Freq. [MHz]	Reading [dBµV/m]	Antenna Factor [dB]	Cable loss [dB]	AMP [dB]	Level [dBµV/m]	Limit [dBµV/m]	Margin [dB]	Detector	Polarity
1	0.18	50.36	19.77	0.07	-29.59	40.61	102.68	62.07	AV	Z
2	0.26	62.98	19.70	0.08	-29.72	53.04	99.46	46.42	AV	Z
3	0.38	53.69	19.75	0.08	-30.00	43.52	95.94	52.42	AV	Z
4	1.66	62.28	20.07	0.13	-31.49	50.99	63.18	12.19	QP	Z
5	2.54	68.45	19.79	0.13	-31.47	56.90	69.54	12.64	QP	Z
6	13.81	55.62	19.95	0.28	-31.24	44.61	69.54	24.93	QP	Z

Note:

1. Level = Reading + Cable Loss + Antenna Factor + AMP
2. If Peak Result complies with QP limit, QP Result is deemed to comply with QP limit.
3. Test setup: 9kHz-150kHz RBW: 300Hz, VBW: 1 kHz, Sweep time: auto.  
150kHz-30MHz RBW: 10kHz, VBW: 30kHz, Sweep time: auto.



# TR-4-E-009 Radiated Emission Test Result

**Test Date:** 2023-08-26 **Tested By:** Johnson Huang  
**EUT:** Phone Holder **Model Number:** VPH-AC9-BK-W  
**Test Mode:** TX Mode **Power Supply:** 120V/60Hz  
**Condition:** Temp:22.5°C;Humi:64.5% **Test Site:** DDT 3# Chamber  
**File Path:** d:\ts\2023 report data\Q23081405 VPH-AC9-BK-W\FCC BELOW 1G  
 9K-30M\20230826-232819\_V  
**Memo:** 10W X

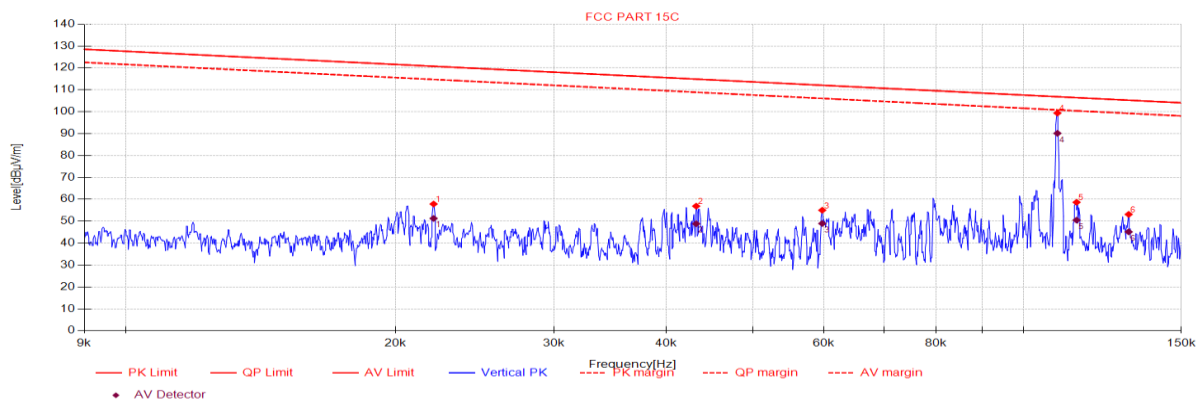

### Suspected Data List

NO.	Freq. [MHz]	Reading [dBµV/m]	Antenna Factor [dB]	Cable loss [dB]	AMP [dB]	Level [dBµV/m]	Limit [dBµV/m]	Margin [dB]	Detector	Polarity
1	0.02	67.33	19.78	0.07	-29.32	57.86	120.73	62.87	PK	X
2	0.04	66.41	19.77	0.07	-29.36	56.89	114.88	57.99	PK	X
3	0.06	64.51	19.84	0.07	-29.39	55.03	112.08	57.05	PK	X
4	0.11	108.92	19.88	0.07	-29.47	99.40	106.84	7.44	PK	X
5	0.11	68.19	19.87	0.07	-29.48	58.65	106.41	47.76	PK	X
6	0.13	62.74	19.84	0.07	-29.51	53.14	105.25	52.11	PK	X

### Final Data List

NO.	Freq. [MHz]	Reading [dBµV/m]	Antenna Factor [dB]	Cable loss [dB]	AMP [dB]	Level [dBµV/m]	Limit [dBµV/m]	Margin [dB]	Detector	Polarity
1	0.02	60.74	19.78	0.07	-29.32	51.27	120.75	69.48	AV	X
2	0.04	58.36	19.77	0.07	-29.36	48.84	114.89	66.05	AV	X
3	0.06	58.44	19.84	0.07	-29.39	48.96	112.08	63.12	AV	X
4	0.11	99.65	19.88	0.07	-29.47	90.13	106.84	16.71	AV	X
5	0.11	60.04	19.87	0.07	-29.48	50.50	106.41	55.91	AV	X
6	0.13	54.75	19.84	0.07	-29.51	45.15	105.25	60.10	AV	X

Note:

- Level = Reading + Cable Loss + Antenna Factor + AMP
- If Peak Result complies with QP limit, QP Result is deemed to comply with QP limit.
- Test setup: 9kHz-150kHz RBW: 300Hz, VBW: 1 kHz, Sweep time: auto.  
150kHz-30MHz RBW: 10kHz, VBW: 30kHz, Sweep time: auto.

## TR-4-E-009 Radiated Emission Test Result

**Test Date:** 2023-08-26      **Tested By:** Johnson Huang  
**EUT:** Phone Holder      **Model Number:** VPH-AC9-BK-W  
**Test Mode:** TX Mode      **Power Supply:** 120V/60Hz  
**Condition:** Temp:22.5°C;Humi:64.5%      **Test Site:** DDT 3# Chamber  
**File Path:** d:\ts\2023 report data\Q23081405 VPH-AC9-BK-W\FCC BELOW 1G  
 9K-30M\20230826-232845\_V  
**Memo:** 10W Y

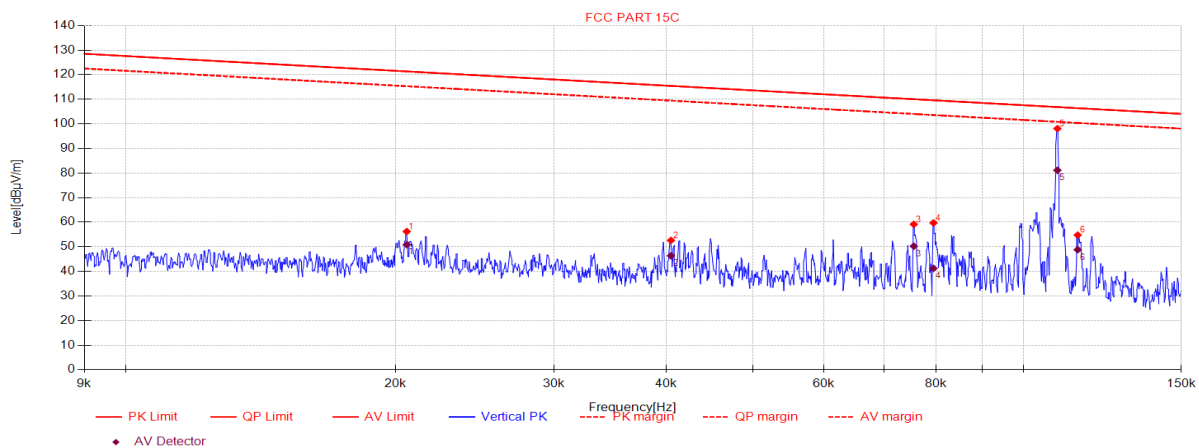

### Suspected Data List

NO.	Freq. [MHz]	Reading [dBμV/m]	Antenna Factor [dB]	Cable loss [dB]	AMP [dB]	Level [dBμV/m]	Limit [dBμV/m]	Margin [dB]	Detector	Polarity
1	0.02	65.67	19.79	0.07	-29.32	56.21	121.33	65.12	PK	Y
2	0.04	62.13	19.75	0.07	-29.35	52.60	115.45	62.85	PK	Y
3	0.08	68.57	19.90	0.07	-29.41	59.13	110.04	50.91	PK	Y
4	0.08	69.19	19.90	0.07	-29.42	59.74	109.60	49.86	PK	Y
5	0.11	107.58	19.88	0.07	-29.47	98.06	106.84	8.78	PK	Y
6	0.11	64.30	19.87	0.07	-29.48	54.76	106.39	51.63	PK	Y

### Final Data List

NO.	Freq. [MHz]	Reading [dBμV/m]	Antenna Factor [dB]	Cable loss [dB]	AMP [dB]	Level [dBμV/m]	Limit [dBμV/m]	Margin [dB]	Detector	Polarity
1	0.02	60.35	19.79	0.07	-29.32	50.89	121.32	70.43	AV	Y
2	0.04	55.89	19.75	0.07	-29.35	46.36	115.45	69.09	AV	Y
3	0.08	59.67	19.90	0.07	-29.41	50.23	110.04	59.81	AV	Y
4	0.08	50.68	19.90	0.07	-29.42	41.23	109.59	68.36	AV	Y
5	0.11	90.65	19.88	0.07	-29.47	81.13	106.84	25.71	AV	Y
6	0.11	58.33	19.87	0.07	-29.48	48.79	106.39	57.60	AV	Y

Note:

- Level = Reading + Cable Loss + Antenna Factor + AMP
- If Peak Result complies with QP limit, QP Result is deemed to comply with QP limit.
- Test setup: 9kHz-150kHz RBW: 300Hz, VBW: 1 kHz, Sweep time: auto.  
150kHz-30MHz RBW: 10kHz, VBW: 30kHz, Sweep time: auto.





# TR-4-E-009 Radiated Emission Test Result

**Test Date:** 2023-08-26 **Tested By:** Johnson Huang  
**EUT:** Phone Holder **Model Number:** VPH-AC9-BK-W  
**Test Mode:** TX Mode **Power Supply:** 120V/60Hz  
**Condition:** Temp:22.5°C;Humi:64.5% **Test Site:** DDT 3# Chamber  
**File Path:** d:\ts\2023 report data\Q23081405 VPH-AC9-BK-W\FCC BELOW 1G 9K-30M\20230826-233002\_V  
**Memo:** 10W X

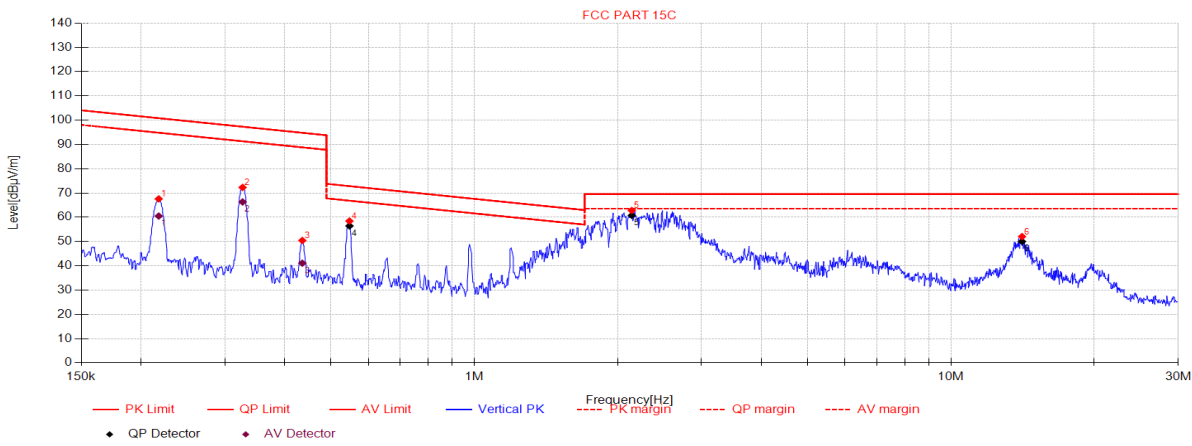

Suspected Data List										
NO.	Freq. [MHz]	Reading [dBµV/m]	Antenna Factor [dB]	Cable loss [dB]	AMP [dB]	Level [dBµV/m]	Limit [dBµV/m]	Margin [dB]	Detector	Polarity
1	0.22	77.44	19.73	0.07	-29.66	67.58	100.84	33.26	PK	X
2	0.33	82.35	19.73	0.08	-29.86	72.30	97.32	25.02	PK	X
3	0.44	60.71	19.77	0.08	-30.13	50.43	94.81	44.38	PK	X
4	0.55	68.95	19.82	0.08	-30.40	58.45	72.84	14.39	PK	X
5	2.14	74.19	19.94	0.13	-31.47	62.79	69.54	6.75	PK	X
6	14.11	63.06	19.94	0.28	-31.24	52.04	69.54	17.50	PK	X

Final Data List										
NO.	Freq. [MHz]	Reading [dBµV/m]	Antenna Factor [dB]	Cable loss [dB]	AMP [dB]	Level [dBµV/m]	Limit [dBµV/m]	Margin [dB]	Detector	Polarity
1	0.22	70.36	19.73	0.07	-29.66	60.50	100.84	40.34	AV	X
2	0.33	76.36	19.73	0.08	-29.86	66.31	97.32	31.01	AV	X
3	0.44	51.36	19.77	0.08	-30.13	41.08	94.81	53.73	AV	X
4	0.55	66.92	19.82	0.08	-30.40	56.42	72.84	16.42	QP	X
5	2.14	72.16	19.94	0.13	-31.47	60.76	69.54	8.78	QP	X
6	14.11	61.03	19.94	0.28	-31.24	50.01	69.54	19.53	QP	X

Note:

- Level = Reading + Cable Loss + Antenna Factor + AMP
- If Peak Result complies with QP limit, QP Result is deemed to comply with QP limit.
- Test setup: 9kHz-150kHz RBW: 300Hz, VBW: 1 kHz, Sweep time: auto.  
150kHz-30MHz RBW: 10kHz, VBW: 30kHz, Sweep time: auto.

# TR-4-E-009 Radiated Emission Test Result

**Test Date:** 2023-08-26 **Tested By:** Johnson Huang  
**EUT:** Phone Holder **Model Number:** VPH-AC9-BK-W  
**Test Mode:** TX Mode **Power Supply:** 120V/60Hz  
**Condition:** Temp:22.5°C;Humi:64.5% **Test Site:** DDT 3# Chamber  
**File Path:** d:\ts\2023 report data\Q23081405 VPH-AC9-BK-W\FCC BELOW 1G 9K-30M\20230826-233032\_V  
**Memo:** 10W Y

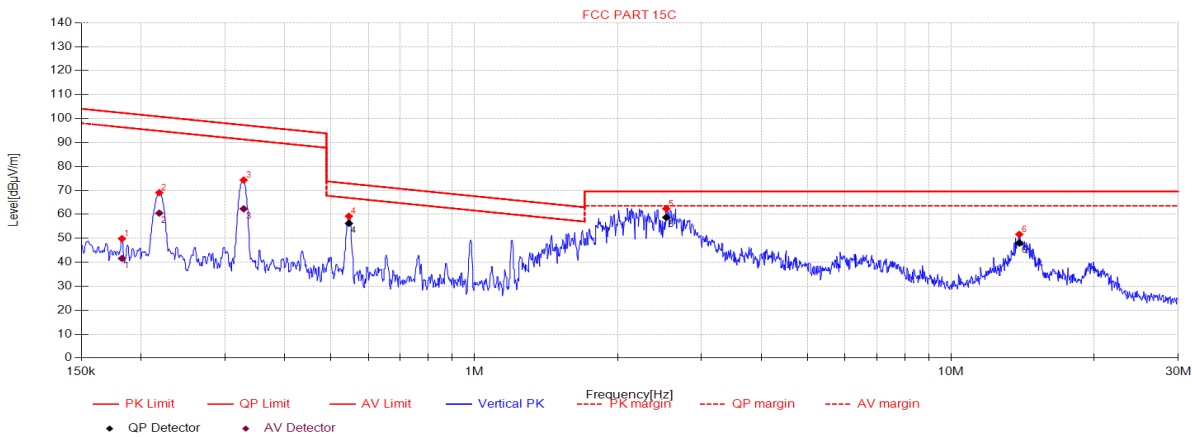

Suspected Data List										
NO.	Freq. [MHz]	Reading [dBµV/m]	Antenna Factor [dB]	Cable loss [dB]	AMP [dB]	Level [dBµV/m]	Limit [dBµV/m]	Margin [dB]	Detector	Polarity
1	0.18	59.61	19.77	0.07	-29.60	49.85	102.38	52.53	PK	Y
2	0.22	78.91	19.73	0.07	-29.66	69.05	100.81	31.76	PK	Y
3	0.33	84.37	19.73	0.08	-29.87	74.31	97.27	22.96	PK	Y
4	0.55	69.72	19.82	0.08	-30.40	59.22	72.86	13.64	PK	Y
5	2.53	73.91	19.79	0.13	-31.47	62.36	69.54	7.18	PK	Y
6	13.92	62.67	19.94	0.28	-31.24	51.65	69.54	17.89	PK	Y

Final Data List										
NO.	Freq. [MHz]	Reading [dBµV/m]	Antenna Factor [dB]	Cable loss [dB]	AMP [dB]	Level [dBµV/m]	Limit [dBµV/m]	Margin [dB]	Detector	Polarity
1	0.18	51.36	19.77	0.07	-29.60	41.60	102.38	60.78	AV	Y
2	0.22	70.36	19.73	0.07	-29.66	60.50	100.81	40.31	AV	Y
3	0.33	72.36	19.73	0.08	-29.87	62.30	97.27	34.97	AV	Y
4	0.55	66.74	19.82	0.08	-30.40	56.24	72.86	16.62	QP	Y
5	2.53	70.27	19.79	0.13	-31.47	58.72	69.54	10.82	QP	Y
6	13.92	59.03	19.94	0.28	-31.24	48.01	69.54	21.53	QP	Y

Note:

- Level = Reading + Cable Loss + Antenna Factor + AMP
- If Peak Result complies with QP limit, QP Result is deemed to comply with QP limit.
- Test setup: 9kHz-150kHz RBW: 300Hz, VBW: 1 kHz, Sweep time: auto.  
150kHz-30MHz RBW: 10kHz, VBW: 30kHz, Sweep time: auto.









## 6 Power Line Conducted Emission

### 6.1. Block diagram of test setup

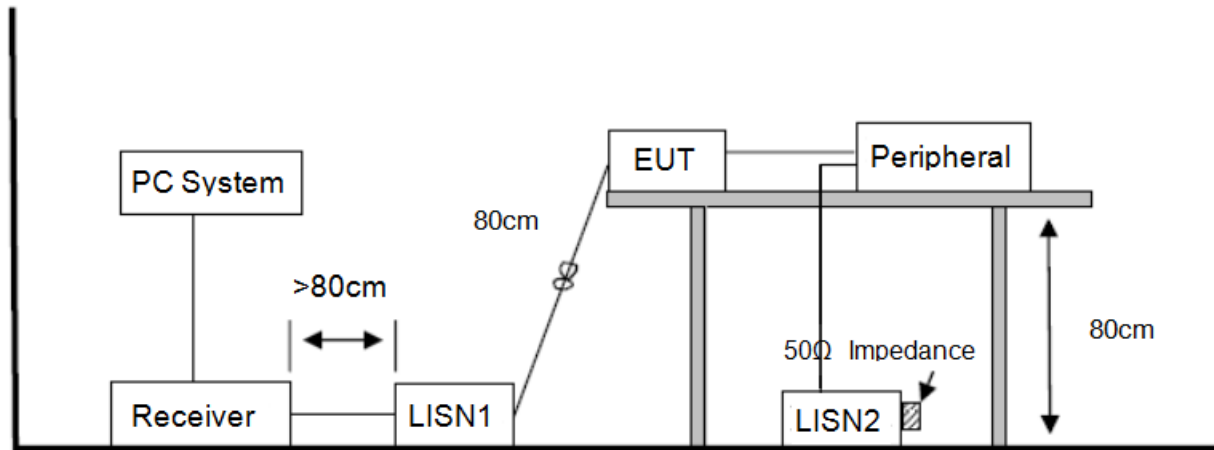

### 6.2. Power line conducted emission limits

Frequency	Quasi-Peak Level dB( $\mu$ V)	Average Level dB( $\mu$ V)
150 kHz ~ 500 kHz	66 ~ 56*	56 ~ 46*
500 kHz ~ 5 MHz	56	46
5 MHz ~ 30 MHz	60	50

Note 1: \* Decreasing linearly with logarithm of frequency.

Note 2: The lower limit shall apply at the transition frequencies.

### 6.3. Test procedure

The EUT and Support equipment, if needed, were put placed on a non-metallic table, 80 cm above the ground plane.

- Configuration EUT to simulate typical usage as described in clause 2.4 and test equipment as described in clause 6.1 of this report.

All I/O cables were positioned to simulate typical actual usage as per ANSI C63.10.

All support equipment power received from a second LISN.

Emissions were measured on each current carrying line of the EUT using an EMI Test Receiver connected to the LISN powering the EUT.

The Receiver scanned from 150 kHz to 30 MHz for emissions in each of the test modes.

During the above scans, the emissions were maximized by cable manipulation.

The test mode(s) described in clause 2.4 were scanned during the preliminary test.

After the preliminary scan, we found the test mode producing the highest emission level.



The EUT configuration and worse cable configuration of the above highest emission levels were recorded for reference of the final test.

EUT and support equipment were set up on the test bench as per the configuration with highest emission level in the preliminary test.

A scan was taken on both power lines, Neutral and Line, recording at least the six highest emissions.

Emission frequency and amplitude were recorded into a computer in which correction factors were used to calculate the emission level and compare reading to the applicable limit.

The test data of the worst-case condition(s) was recorded.

The bandwidth of test receiver is set at 9 kHz.

#### **6.4. Test result**

##### **Pass. (See below detailed test result)**

Note1: All emissions not reported below are too low against the prescribed limits.

Note2: “----” means Peak detection; “- - - -” means Average detection.

Note3: Pre-test AC conducted emission at both voltage AC 120V/60Hz and AC 240V/60Hz, recorded worse case (AC 120V/60Hz).

# TR-4-E-010 Conducted Emission Test Result

**Test Site** : DDT 1# Shield Room D:\2023 CE report data\Q23081405-2E\FCC.EM6  
**Test Date** : 2023-08-28 **Tested By** : Johnson Huang  
**EUT** : Phone Holder **Model Number** : VPH-AC9-BK-W  
**Power Supply** : AC 120V/60Hz **Test Mode** : TX mode  
**Condition** : TEMP:22.6°C, RH:56.7% **LISN** : 2022 1# ENV216/LINE  
**Memo** :

Data: 2

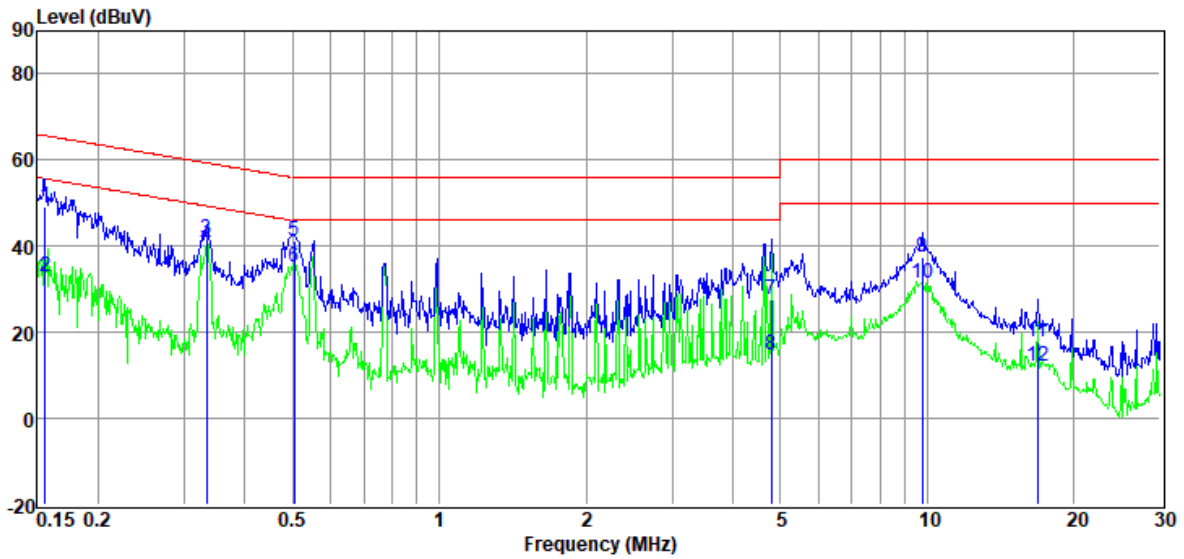

Item	Freq.	Read Level	LISN Factor	Cable Loss	Pulse Limiter Factor	Result Level	Limit Line	Over Limit	Detector	Phase
(Mark)	(MHz)	(dBuV)	(dB)	(dB)	(dB)	(dBuV)	(dBuV)	(dB)		
1	0.16	29.48	9.63	0.01	9.93	49.05	65.69	-16.64	QP	LINE
2	0.16	13.34	9.63	0.01	9.93	32.91	55.69	-22.78	Average	LINE
3	0.33	21.78	9.74	0.01	9.91	41.44	59.35	-17.91	QP	LINE
4	0.33	20.59	9.74	0.01	9.91	40.25	49.35	-9.10	Average	LINE
5	0.50	21.59	9.70	0.01	9.92	41.22	56.00	-14.78	QP	LINE
6	0.50	15.48	9.70	0.01	9.92	35.11	46.00	-10.89	Average	LINE
7	4.80	8.25	9.53	0.05	9.91	27.74	56.00	-28.26	QP	LINE
8	4.80	-4.87	9.53	0.05	9.91	14.62	46.00	-31.38	Average	LINE
9	9.76	18.00	9.51	0.09	9.96	37.56	60.00	-22.44	QP	LINE
10	9.76	11.80	9.51	0.09	9.96	31.36	50.00	-18.64	Average	LINE
11	16.84	-1.93	9.68	0.13	9.95	17.83	60.00	-42.17	QP	LINE
12	16.84	-7.49	9.68	0.13	9.95	12.27	50.00	-37.73	Average	LINE

Note:

1. Result Level = Read Level + LISN Factor + Pulse Limiter Factor + Cable loss.
2. If QP Result complies with AV limit, AV Result is deemed to comply with AV limit.
3. Test setup: RBW: 200 Hz (9 kHz—150 kHz), 9 kHz (150 kHz—30 MHz).
4. Step size: 80Hz (0.009MHz-0.15MHz), 4 kHz (0.15MHz-30MHz), Scan time: auto.

# TR-4-E-010 Conducted Emission Test Result

**Test Site** : DDT 1# Shield Room D:\2023 CE report data\Q23081405-2\FCC.EM6  
**Test Date** : 2023-08-28 **Tested By** : Johnson Huang  
**EUT** : Phone Holder **Model Number** : VPH-AC9-BK-W  
**Power Supply** : AC 120V/60Hz **Test Mode** : TX mode  
**Condition** : TEMP:22.6°C, RH:56.7% **LISN** : 2022 1# ENV216/NEUTRAL  
**Memo** :

Data: 4

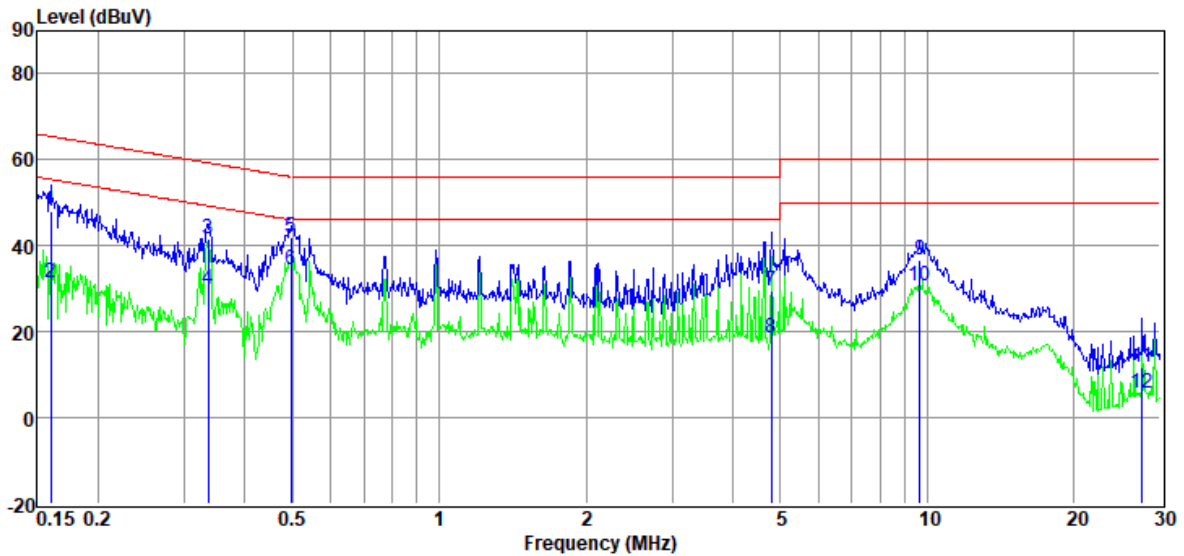

Item (Mark)	Freq. (MHz)	Read Level (dBμV)	LISN Factor (dB)	Cable Loss (dB)	Pulse Limiter Factor (dB)	Result Level (dBμV)	Limit Line (dBμV)	Over Limit (dB)	Detector	Phase
1	0.16	28.29	9.82	0.01	9.93	48.05	65.47	-17.42	QP	NEUTRAL
2	0.16	11.49	9.82	0.01	9.93	31.25	55.47	-24.22	Average	NEUTRAL
3	0.34	22.02	9.73	0.01	9.91	41.67	59.31	-17.64	QP	NEUTRAL
4	0.34	10.32	9.73	0.01	9.91	29.97	49.31	-19.34	Average	NEUTRAL
5	0.50	22.53	9.60	0.01	9.92	42.06	56.05	-13.99	QP	NEUTRAL
6	0.50	15.06	9.60	0.01	9.92	34.59	46.05	-11.46	Average	NEUTRAL
7	4.80	9.83	9.67	0.05	9.91	29.46	56.00	-26.54	QP	NEUTRAL
8	4.80	-1.02	9.67	0.05	9.91	18.61	46.00	-27.39	Average	NEUTRAL
9	9.65	16.74	9.78	0.09	9.96	36.57	60.00	-23.43	QP	NEUTRAL
10	9.65	10.75	9.78	0.09	9.96	30.58	50.00	-19.42	Average	NEUTRAL
11	27.56	-8.16	9.80	0.16	10.00	11.80	60.00	-48.20	QP	NEUTRAL
12	27.56	-14.33	9.80	0.16	10.00	5.63	50.00	-44.37	Average	NEUTRAL

Note:

1. Result Level = Read Level + LISN Factor + Pulse Limiter Factor + Cable loss.
2. If QP Result complies with AV limit, AV Result is deemed to comply with AV limit.
3. Test setup: RBW: 200 Hz (9 kHz—150 kHz), 9 kHz (150 kHz—30 MHz).
4. Step size: 80Hz (0.009MHz-0.15MHz), 4 kHz (0.15MHz-30MHz), Scan time: auto.

## **7 Antenna Requirements**

### **7.1. Limit**

For intentional device, according to FCC 47 CFR Section 15.203, an intentional radiator shall be designed to ensure that no antenna other than that furnished by the responsible party shall be used with the device. The use of a permanently attached antenna or of an antenna that uses a unique coupling to the intentional radiator shall be considered sufficient to comply with the provisions of this section. The manufacturer may design the unit so that a broken antenna can be replaced by the user, but the use of a standard antenna jack or electrical connector is prohibited.

### **7.2. Result**

The antenna used for this product is inductive loop coil antenna and that no antenna other than that furnished by the responsible party shall be used with the device.

## 9 Photos of the EUT

Please refer to the Appendix I.

**END OF REPORT**