

成品尺寸：120*160mm

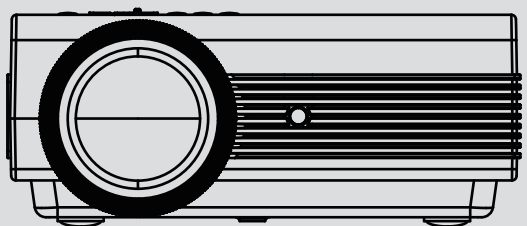

MULTIMEDIA PROJECTOR

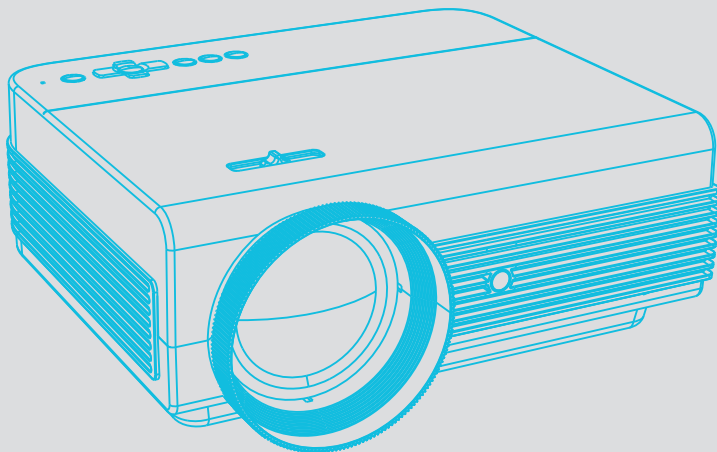

User Manual

Model: V6

FCC ID: 2A3DJ-V6

FC RoHS CE    Made in China

 Help@projector-direct.com

 Help@projector-direct.com

CONTENTS

Notice and Package List -----	01
Remote Control -----	02
Installation -----	03~06
1.Installation method-----	03
2.Projector distance and size-----	03
3.Install on the ceiling-----	04
Projector Overview -----	07
Image Adjustment	
1.Manual keystone correction-----	08
2.Focus adjustment-----	08
3.ZOOM function-----	09
How to Connect Smartphone?	
1.Wireless connection-----	10~15
2.Bluetooth connection-----	16
User Operating Guidance	
1.How to connect VGA?-----	17
2.How to connect USB?-----	18
3.How to connect HDMI?-----	19
4.How to connect TF?-----	20
5.How to connect AV?-----	21
6.How to connect 3.5mm audio interface?-----	22
How to Connect Other Devices?	
1.Computer-----	23
2.MacBook / MacBook Air-----	24
3.Amazon Fire TV Stick-----	24
Menu Setting -----	25~28
Product Specs and Tech -----	28
FCC Statement -----	29-30
Warranty & Contact us -----	31

Notice and Package List

Notice

1. Please read the user manual carefully before using the projector.
2. Please use the standard power cord with ground wire, to ensure a stable power supply.
3. Please use the same power voltage as marked on the projector.
- 4 Please do not disassemble the projector by yourself, otherwise, the warranty will be void.
5. Please do not look into the lens when the projector is working, otherwise it may hurt your eyes.
6. Please do not cover the projector ventilation holes with any material.
7. Please keep the projector away from water or any other liquid as it is not waterproof.
8. Please don't put the projector in wet or moist conditions to prevent electric shock.
9. Please turn off and unplug from the power supply if not using the projector for a long time.
10. Please use the original packing foam or other anti-shock material when relocating the projector.
11. Please contact our customer support if you encounter any problem with the projector.

Package List

Projector	Power Lead	AV Singal Cable	Remote Control (Battery not included)	HDMI Cable
1 PCS	1 PCS	1 PCS	1 PCS	1 PCS

Remote Control

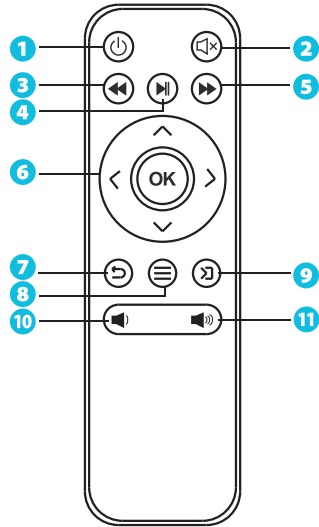

- 1 Power On / Off
- 2 Mute
- 3 Rewind
- 4 Play / Pause / Full Screen
- 5 Fast Forward
- 6 Arrow Keys
- 7 Back
- 8 Menu Setting
- 9 Interfaces selection
- 10 Volume -
- 11 Volume +

Cautions:

- Do not submerge the remote control in the water.
- Do not put the remote control near fire or in wet / hot places.
- Do not use old and new batteries together in the remote control.
- Please take the batteries out if not using the remote control for a long time to avoid battery leakage.
- Please point the remote control at the projector while use, cause it contains an IR receiver.
- Please use the remote control within 6 meters distance and 30 degree angle.

Installation

1.Install method

The projector can be hanged on the ceiling with a special hanger frame, and keep the projector at a height where its lens is axial symmetry to the screen. If this is not possible, use the keystone correction function to adjust the image.

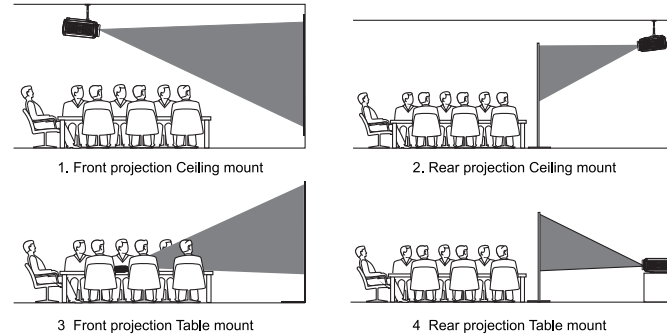

2.Projector distance and size

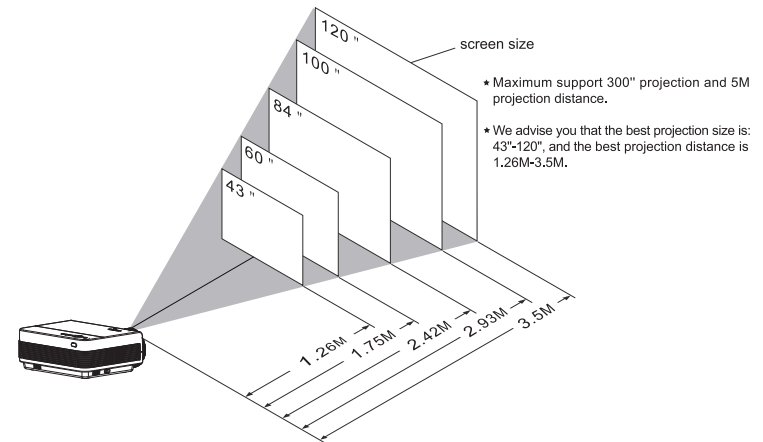

Installation

3.Install on the ceiling

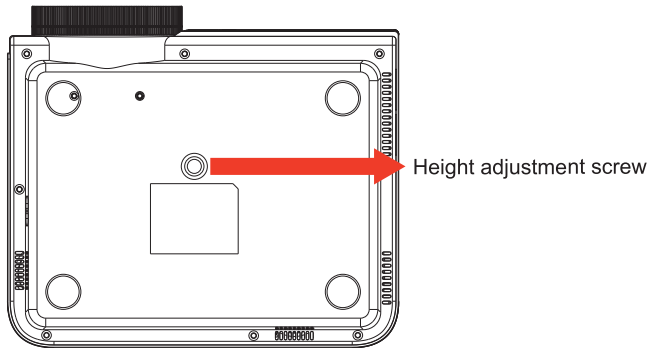
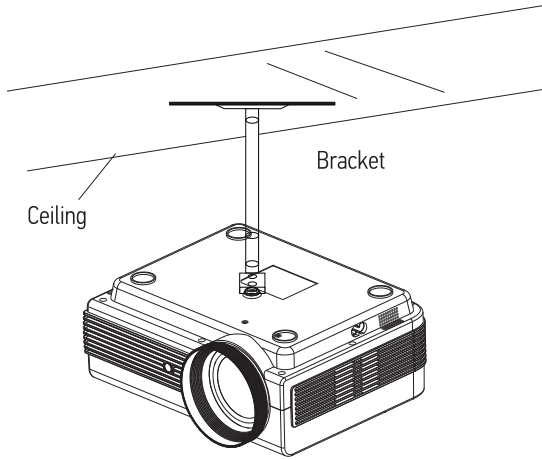

Installation

1. Connect the power cable to the projector.

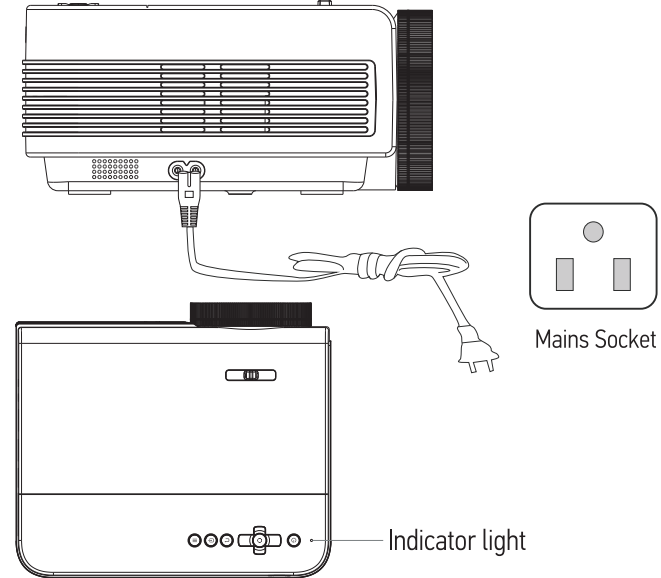

2. Turn On: After connecting the power, please wait for 3-5 seconds, the indicator light turns red to green, and then green to red again, at this time you can press the power on / off button once and the projector will start normally.
3. Turn Off: Press the power on / off button once and it will display whether to make it off. If you want to turn it off, just press the power button again, and the projector will be off immediately. Otherwise, there is no need to press the power button a second time.

Installation

Different Interfaces Introduce

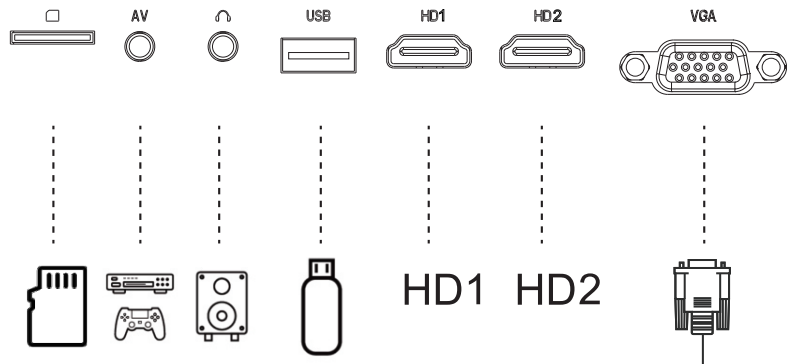

Connect multiple devices and applications.

Projector Overview

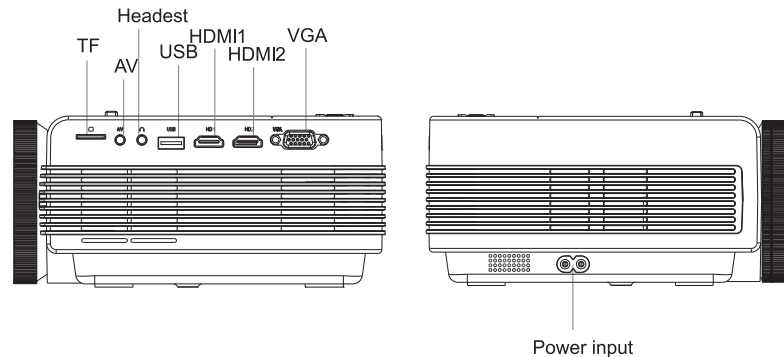
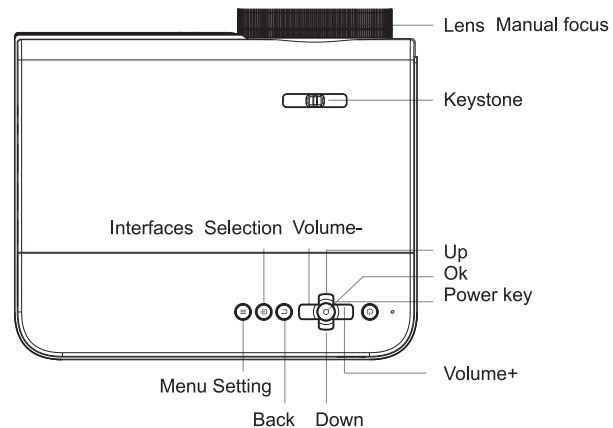
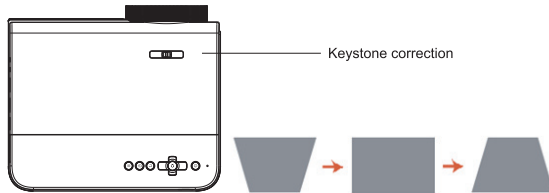

Image Adjustment

1. Manual keystone correction(Maximum: $\pm 15^\circ$)

Slowly move the keystone correction ring on the top of the projector until the image change to be a rectangle. The keystone correction can be adjusted up to $\pm 15^\circ$ (vertical).



2. Focus adjustment

Rotate the focus ring slowly, at the same time check the focus point carefully. The best focus point for the lens would be where the image is most clear.

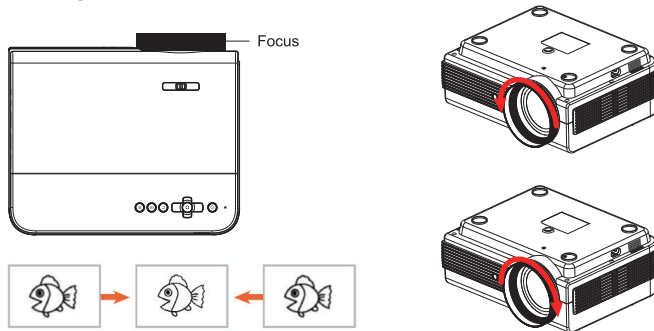

Note:

If it is still blurry, please try to adjust the projection distance.

Image Adjustment

3.ZOOM function

- 1 Press the "Menu Setting" and choose "PICTURE", then click the function of " Reduce Display Size 100%".

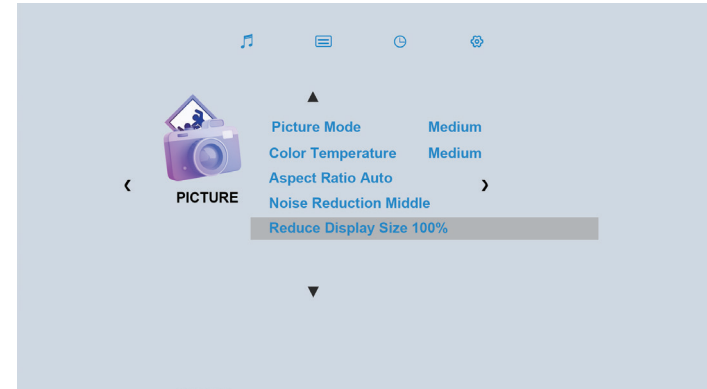

- 2 Then you can adjust the picture ratio 75-100%, just choose your favorite mode, you can enjoy the ZOOM function's fun.

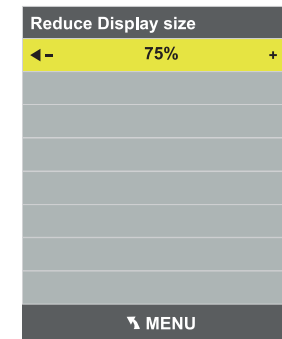
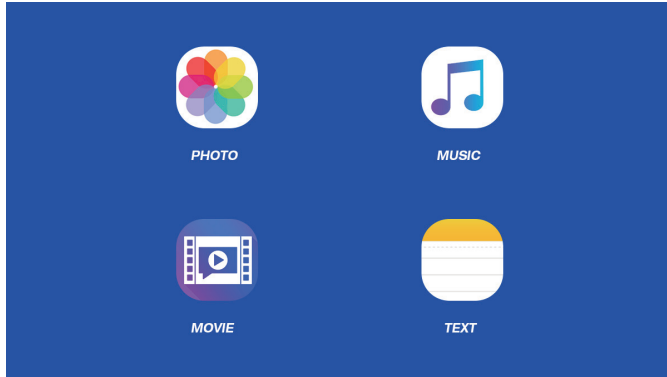

Image Adjustment

Multimedia boot screen

The projector's normal start-up screen is as follows:



How to Connect Smartphone?

Wireless Connection

① iOS screen (ios devices have 3 methods to connect)

1) Wireless connection without Wi-Fi router(for iOS devices)

Input Source
VGA
HDMI 1
HDMI 2
Screen Mirroring
AV
USB
TF
OK

Step1: Projector doesn't need to connect to the Wi-Fi router.

How to Connect Smartphone?

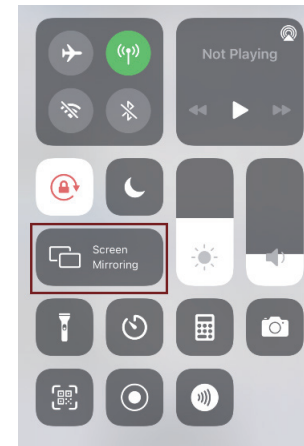
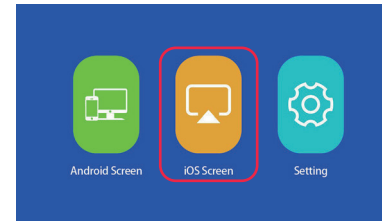

Step 2: Click the "Interfaces Option" button and choose the "Screen Mirroring" with "ios Screen"(you can see the projector's name and password when you choose ios screen mirroring on the projector).

Step 3: Turn on Wi-Fi on your iOS device and search for the network name of the projector and put the password into connecting, it will show connect successfully.

Step 4: Turn on the "Screen Mirroring" function on your iOS device, select the device name of the projector.

Step 5: After the above steps, you can play the video of your mobile phone synchronously as

How to Connect Smartphone?

2) Wireless connection with WiFi router(for iOS devices)

Step1: Click "Interfaces Selection" and choose "Screen Mirroring", enter the "Setting" mode and select the "Wi-Fi search" function, connect the router that you wanted and put in passwords.

Step2: Open your smartphone's Wi-Fi and connect to the same router.

Step3: At the same time, make your smartphone turn on the "screen mirroring" function, in this way, you can start to operate as you like.

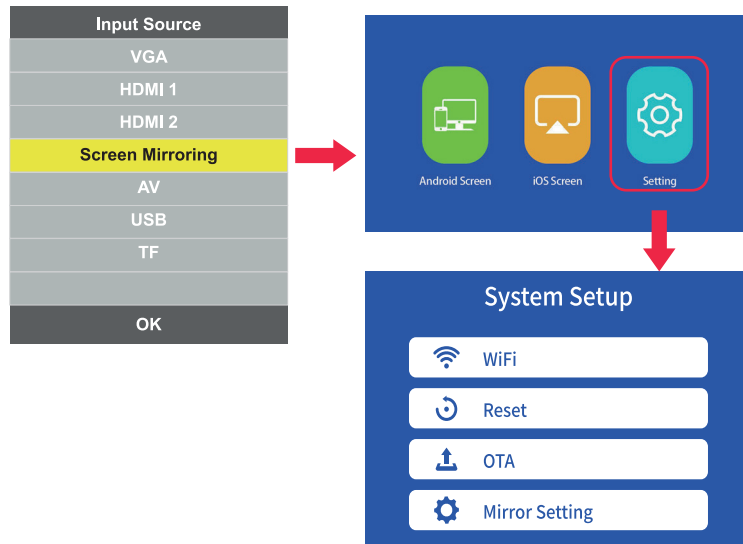

How to Connect Smartphone?

WiFi	Connect the projector to Wi-Fi router
Reset	Restore the Screen Mirroring function factory Settings
OTA	Online upgrade
Mirror Setting	Mirror mode/Airplay mode



3) Wired connection(for iOS devices)

Step1: Step1: Click the "Interfaces Selection" button and select the "Screen Mirroring" function.

Step2: Connect your iOS device to the projector USB port with a USB cable.

Step3: For the first time, your iOS device will pop up a trust prompt. Confirm "Trust", then the screen mirroring will start.

Trust This Computer?

Your settings and data will be accessible from this computer when connected wirelessly or using a cable.

Trust

Don't Trust

How to Connect Smartphone?

② Android screen (Android devices have 2 methods to connect)

1) Wireless connection(for Android devices)

Step 1: Click the "Interfaces Option" button and choose the "Screen Mirroring" function. (enter "Android Screen" and you can see the projector's name and password when you choose screen mirroring).

Step 2: Turn on Wi-Fi on your Android device and search for the network name of the projector and put the password into connecting.

Step 3: Turn on the "Wireless Projection" function on your Android smartphone, select and connect that device name of the projector.

Step 4: Now you can start to use the screen mirroring function with your phone.

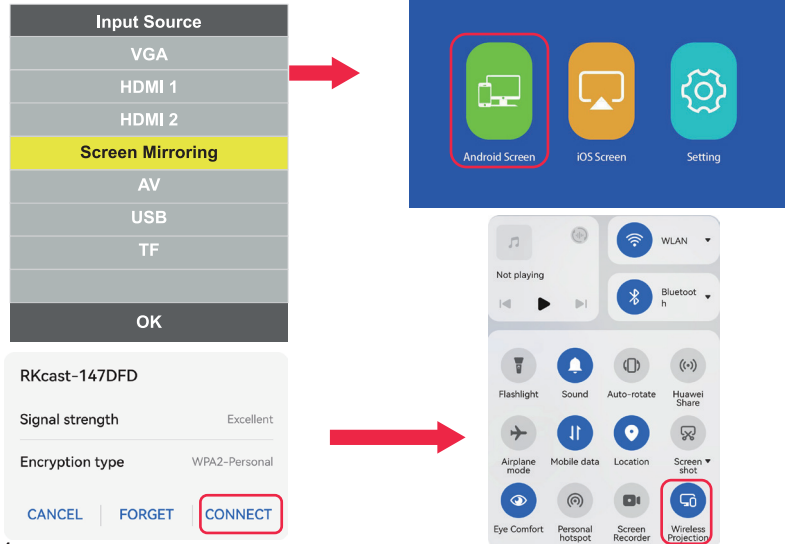

How to Connect Smartphone?

Note:

-Some Android devices may not support screen mirroring due to the compatibility."

-Some Android devices may only transfer the display without audio due to the protocol restrictions

2) Wired connection (for Android devices)

Step 1: Click the "Interfaces Option" button and choose the "Screen Mirroring" function.

Step 2: According to the prompt, download and install the "ByteFlymirror" APP.

Step 3: Allow ByteFlymirror to record / project the screen.

Step 4: Now you can start to use the wired connection function with your phone.

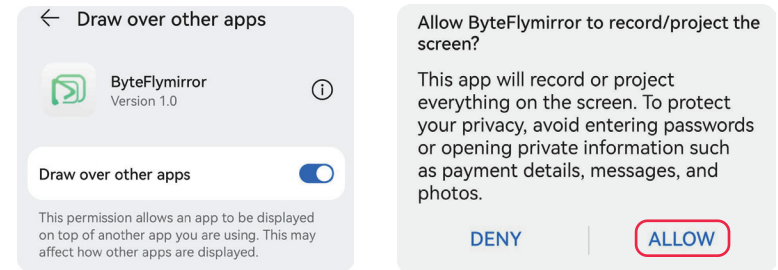

How to Connect Smartphone?

3 Bluetooth connection

1. Press the " Menu Setting" and choose "SOUND" & Bluetooth On", start to search the device and try to connect.

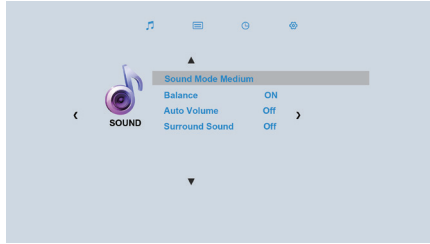

2. When it shows the connection is successful, you could use your device.

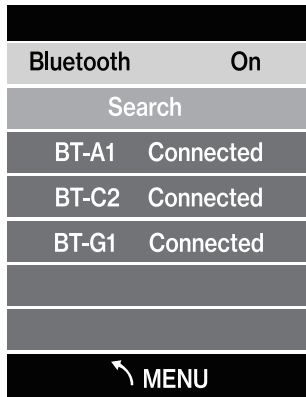

Please Kindly Know That:

It is suitable for devices such as Bluetooth headsets, Bluetooth speakers, various Bluetooth devices, etc... Wireless connect function which is more convenient for your daily life!

User Operating Guidance

How to connect VGA?

Step 1: Click interfaces selection button and select VGA.

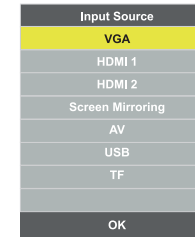
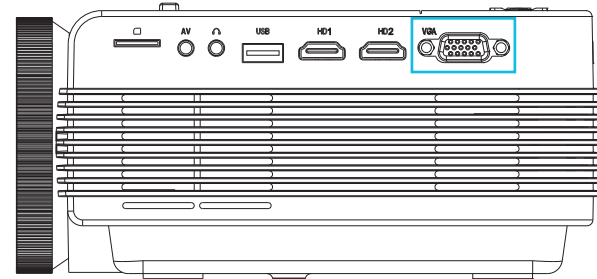

Notice:

When using the VGA interface to connect the computer and the projector, the VGA signal cable must be tightened, otherwise, the projected image may have a color cast problem. If the problem is not solved after tightening, you can try to replace the cable.

User Operating Guidance

How to Connect USB?

Step 1: Click the interfaces selection button and select USB.

Step 2: Insert the USB flash into the USB slot.

Supported multimedia formats

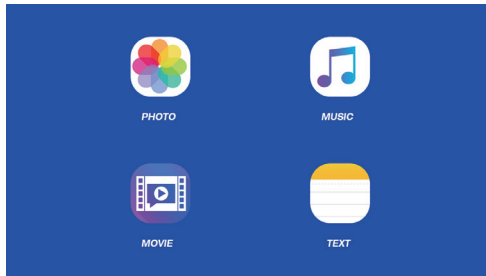
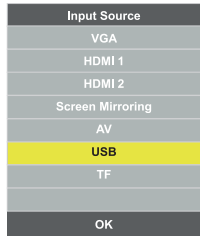
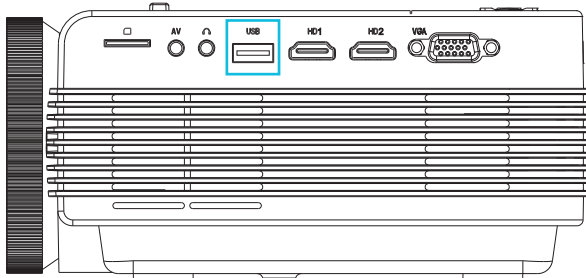

Click and choose the content that you want to show:

VIDEO / MUSIC / PHOTOS / TEXT

Note: click “▶||” to view in full screen.

User Operating Guidance

How to connect HDMI?

Step 1: Click the interfaces selection button and select HDMI.

Step 2: Use the HDMI slot to connect computers and HDMI-compatible devices.

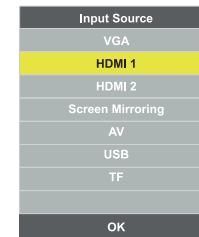
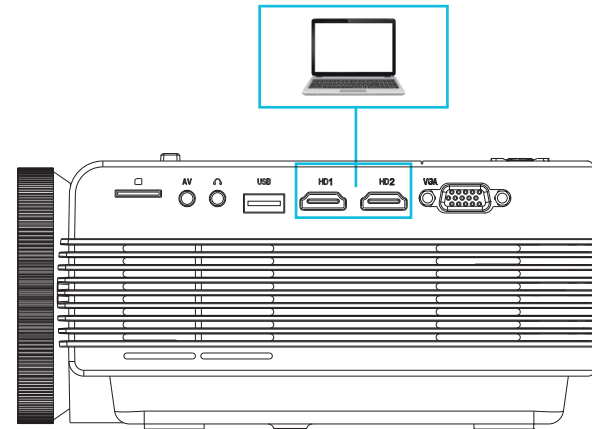

User Operating Guidance

How to connect TF?

Insert the Micro SD card into the TF slot.

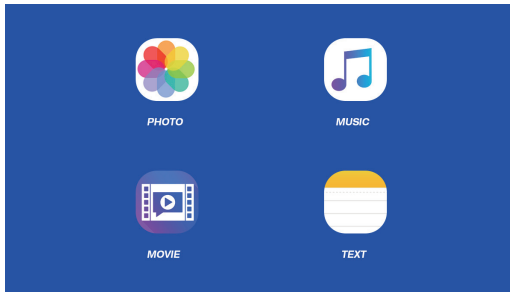
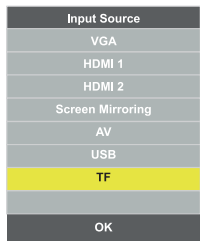
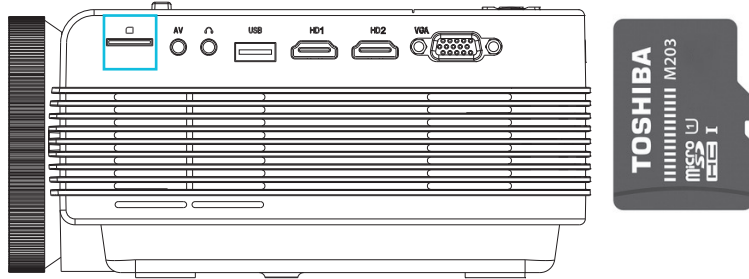

Click and choose the content that you want to show:
VIDEO / MUSIC / PHOTOS / TEXT

Notice:

Support most files format (picture / video / text Word & Excel & PPT)

Click “▶||” to view in full screen.

User Operating Guidance

How to connect AV?

Step 1: Click the interfaces selection button and select AV.

Step 2: Use a 3-in-1 AV cable to connect to the projector as shown below.

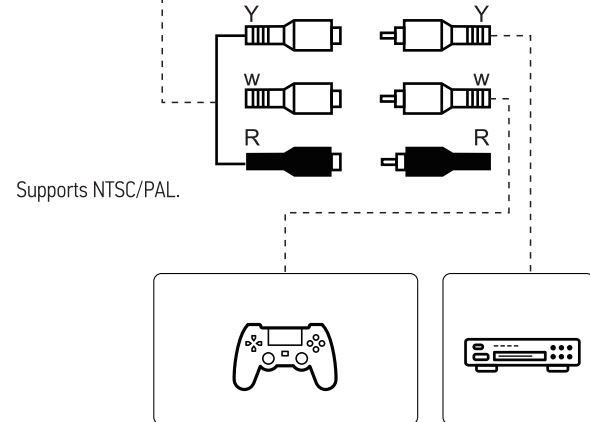
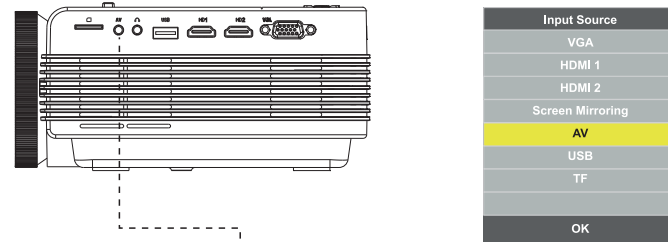

User Operating Guidance

① How to connect 3.5mm audio interface?

Use headphones or speaker equipment to connect the 3.5mm audio interface.

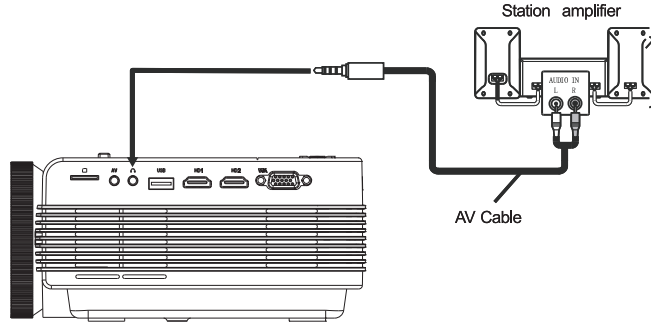

Note: This projector does not support Dolby sound.

② Connect to the soundbar / Speaker

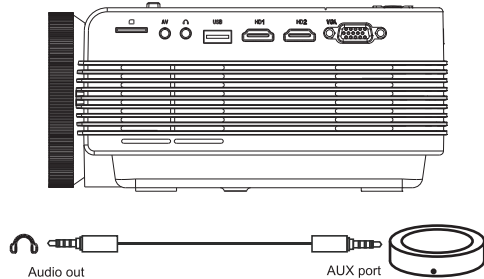

If your speaker has an AUX port, please use your 3.5mm audio cable to connect the projector and your speaker as the picture shows, enter the interfaces selection page to select(AV) as the signal source.

How to Connect Other Devices?

① Connect to Computer

Using the HDMI cable in the package to connect with projector. (An HDMI connection is recommended for projecting movies, videos, and other files which need to be HD.)

- 1). Turn on your computer and the projector.
- 2). Connect the HDMI cable to your computer's HDMI port.
- 3). Connect the other end to any available HDMI port on your projector.
- 4). Press the "Interfaces Select" button to enter the interface of the input source.
- 5). Select HDMI source to project any files on your computer.
- 6). On your laptop, hold down the keyboard keys "Win+P" button to change your display mode.

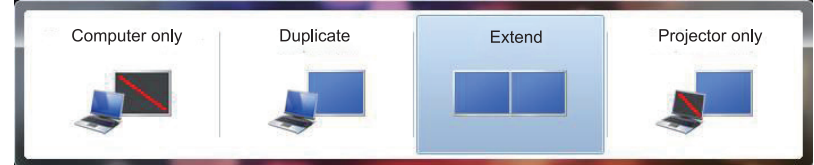

The computer only: Is the default option - only displays on the main monitor.

Duplicate: Make all of the monitors display the same things duplicating the desktop on each monitor.

Extend: Make all of your monitors act like one big monitor extending the desktop across all of them.

Projector only: Displays only on the secondary monitor like a projector.

How to Connect Other Devices?

You can change your screen resolution:

Choose Star-Control Panel-Appearance and Personalization-Adjust Screen Resolution

Choose Start→Control Panel→Appearance and Personalization→Adjust Screen Resolution.

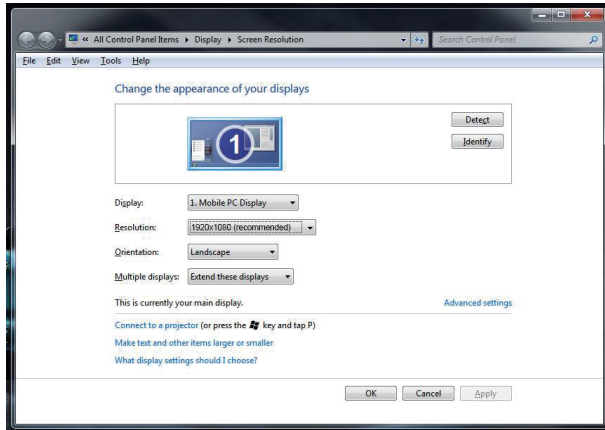

2 Connect to MacBook / MacBook Air

- 1). Choose the media signal channel "HDMI".
- 2). Use a Type-C to HDMI adapter to connect your MacBook, or a Mini Display to HDMI adapter to connect with your Macbook Air(Our Package did not include the adapter, you can purchase it on Amazon store)"

3 Connect to Amazon Fire TV Stick

- 1). Plug the TV stick into the HDMI port of the projector.
- 2). Choose the media signal channel "HDMI".

Menu Setting

4 Menu setting options include : **Picture / Sound / Time / Option Menu**
1 **Picture Menu**

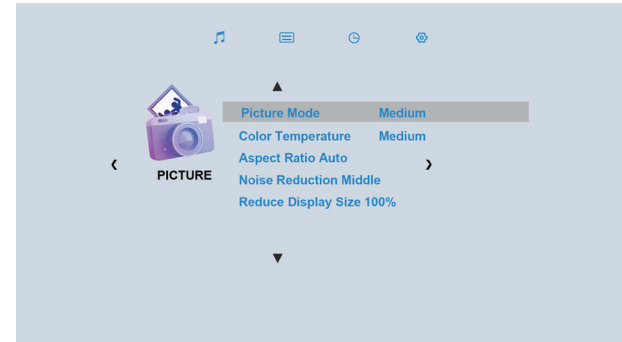

Menu	Content
Picture Mode	Medium / Soft / User / Vivid
Color Temperature	Medium / Warm / User / Cool
Aspect	Auto / 4:3 / 16:9
Noise Reduction	Off / Low / Middle / High / Default
Reduce Display Size	0-100

Menu Setting

2 Connect to the soundbar / Speaker

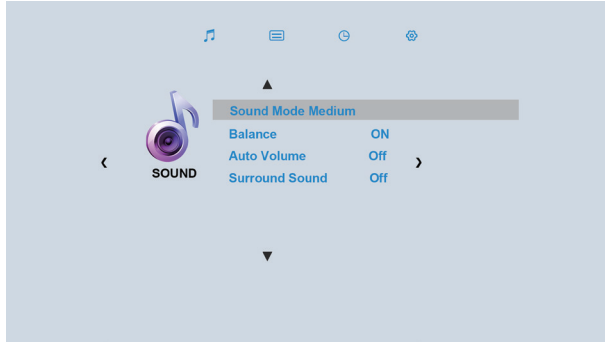

Menu	Content
Sound Mode	Medium / Music / Home / Sport / User
Balance	-50~0~50
Auto Volume	On / Off
Surround Sound	SRS TruSurround XT / OFF / Surround
Bluetooth	On / Off

For Airpods: Open Airpods and press and hold the back button for 3-4 seconds to search for and connect to Airpods.

Menu Setting

3 Time Set

Step 1: Click the interfaces selection button and select AV.

Step 2: Use a 3-in-1 AV cable to connect to the projector as shown below.

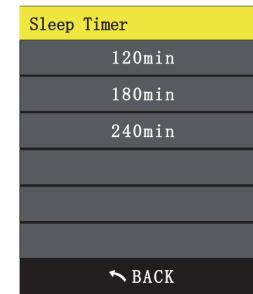
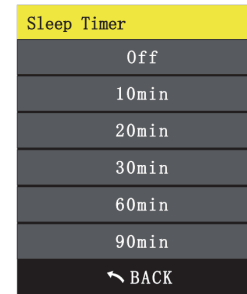
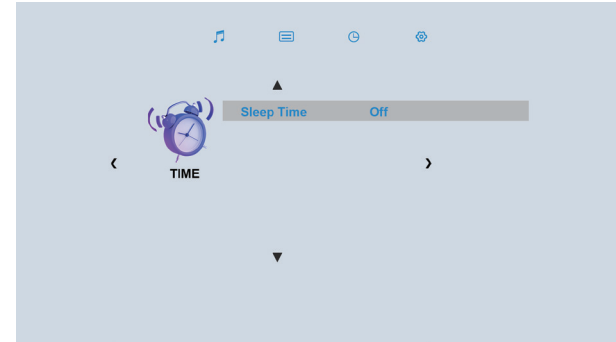

Menu	Content
Time	Off / 10min / 20min / 30min / 60min / 90min / 120min / 180min / 240min

Menu Setting

4 Option Menu

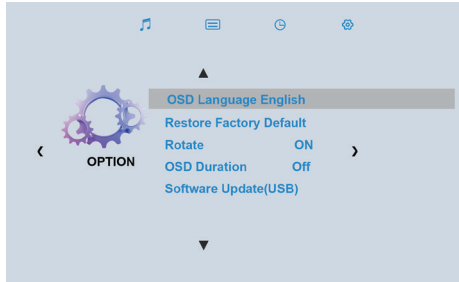

Menu	Content
OSD Language	23 languages available
Restore Factory Default	Restore factory default
Rotate	Adjusting the projection direction mode: Front / Rear / Front / Ceiling / Rear / Ceilin
OSD Duration	OFF / 5 sec / 10 sec / 15 sec
SoftWare Update (USB)	Software upgrade

Product Specs and Tech

Display	LCD
Light Source	LED
Native Resolution	1920*1080 DPI
Display Colors	16.7 Million
Power Voltafe	100-240V~
Keystone	±15°

FCC Statement

This equipment has been tested and found to comply with the limits for a Class B digital device, pursuant to part 15 of the FCC Rules. These limits are designed to provide reasonable protection against harmful interference in a residential installation. This equipment generates, uses and can radiate radio frequency energy and, if not installed and used in accordance with the instructions, may cause harmful interference to radio communications. However, there is no guarantee that interference will not occur in a particular installation. If this equipment does cause harmful interference to radio or television reception, which can be determined by turning the equipment off and on, the user is encouraged to try to correct the interference by one or more of the following measures:

- Reorient or relocate the receiving antenna.
- Increase the separation between the equipment and receiver.
- Connect the equipment into an outlet on a circuit different from that to which the receiver is connected.
- Consult the dealer or an experienced radio/TV technician for help.

Caution: Any changes or modifications to this device not explicitly approved by the manufacturer could void your authority to operate this equipment.

FCC Statement

This device complies with part 15 of the FCC Rules. Operation is subject to the following two conditions: (1) This device may not cause harmful interference, and (2) this device must accept any interference received, including interference that may cause undesired operation.

RF Exposure Information

This equipment complies with FCC radiation exposure limits set forth for an uncontrolled environment. This equipment should be installed and operated with a minimum distance of 20cm between the radiator and your body.

Warranty & Contact Us

EXTRA 5 YEARS WARRANTY

Fill in your order number and Scan QR or Email us to register for the Extra 5 Years Warranty: ✉ Help@projector-direct.com



Scan Me to Register

Under the framework of the Extra 5-Years Warranty, we will provide free technical & maintenance guidance, replacement accessories in a special situation, and timely and effective response, ensure the normal operation of the product and the performance of the product always reaches the best condition.

⚠ Note

1. Only suitable for home entertainment in a dark environment. During the daytime, please draw the curtains.
2. Dolby audio is NOT supported.
3. Do not obstruct the air vents when using.
UNPLUG & PREVENT DUST from entering when not in use.