

FCC RADIO TEST REPORT

FCC ID:2A3DJ-Q6

Product: PROJECTOR

Trade Mark: N/A

Model No.: Q6-2

Family Model: Q6-5,Q6-6,Q6-8,Q6-9

Report No.: S22062206002004

Issue Date: 11 Jul. 2022

Prepared for

ShenZhen Powerful Photoelectron Co., Ltd
5th Floor, Building 3, Zone B, Hongfa Science and Technology
Industrial Park, Tangtou Community, Shiyan Street, Baoan District,
Shenzhen

Prepared by

Shenzhen NTEK Testing Technology Co., Ltd.
1/F, Building E, Fenda Science Park, Sanwei Community,
Xixiang Street Bao'an District, Shenzhen 518126 P.R. China
Tel. 400-800-6106, 0755-2320 0050, 0755-2320 0090
Website: <http://www.ntek.org.cn>

TEST RESULT CERTIFICATION

Applicant's name : ShenZhen Powerful Photoelectron Co., Ltd
Address : 5th Floor, Building 3, Zone B, Hongfa Science and Technology Industrial Park, Tangtou Community, Shiyan Street, Baoan District, Shenzhen
Manufacturer's Name..... : ShenZhen Powerful Photoelectron Co., Ltd
Address : 5th Floor, Building 3, Zone B, Hongfa Science and Technology Industrial Park, Tangtou Community, Shiyan Street, Baoan District, Shenzhen

Product description

Product name..... : PROJECTOR
Model and/or type reference : Q6-2
Family Model..... : Q6-5,Q6-6,Q6-8,Q6-9

Standards..... : FCC Part15.407

Test procedure ANSI C63.10-2013 and KDB 789033 D02 General UNII Test Procedures
New Rules v02r01
FCC KDB 662911 D01 Multiple Transmitter Output v02r01

This device described above has been tested by NTEK, and the test results show that the equipment under test (EUT) is in compliance with the FCC requirements. And it is applicable only to the tested sample identified in the report.

This report shall not be reproduced except in full, without the written approval of NTEK, this document may be altered or revised by NTEK, personnel only, and shall be noted in the revision of the document.

Date of Test

Date (s) of performance of tests 22 Jun. 2022 ~ 10 Jul. 2022

Date of Issue 11 Jul. 2022

Test Result..... Pass

Testing Engineer : Susan Li
(Susan Li.)

Authorized Signatory : Alex Li
(Alex Li)

Table of Contents

	Page
1. SUMMARY OF TEST RESULTS	6
1.1 FACILITIES AND ACCREDITATIONS	7
1.2 MEASUREMENT UNCERTAINTY	7
1 . GENERAL INFORMATION	8
1.1 GENERAL DESCRIPTION OF EUT	8
1.2 DESCRIPTION OF TEST MODES	10
1.3 BLOCK DIGRAM SHOWING THE CONFIGURATION OF SYSTEM TESTED	11
1.4 DESCRIPTION OF SUPPORT UNITS(CONDUCTED MODE)	12
1.5 EQUIPMENTS LIST FOR ALL TEST ITEMS	13
2 . EMC EMISSION TEST	15
2.1 CONDUCTED EMISSION MEASUREMENT	15
2.1.1 APPLICABLE STANDARD	15
2.1.2 CONFORMANCE LIMIT	15
2.1.3 TEST CONFIGURATION	15
2.1.4 TEST PROCEDURE	15
2.2 RADIATED EMISSION MEASUREMENT	18
2.2.1 APPLICABLE STANDARD	18
2.2.2 CONFORMANCE LIMIT	18
2.2.3 MEASURING INSTRUMENTS	18
2.2.4 TEST CONFIGURATION	19
2.2.5 TEST PROCEDURE	20
2.2.6 TEST RESULTS (9KHZ – 30 MHZ)	21
2.2.7 TEST RESULTS (30MHZ – 1GHZ)	22
2.2.8 TEST RESULTS (1GHZ-18GHZ)	24
2.2.10 TEST RESULTS (18GHZ-40GHZ)	26
3 . POWER SPECTRAL DENSITY TEST	29
3.1 APPLIED PROCEDURES / LIMIT	29
3.2 TEST PROCEDURE	30
3.3 DEVIATION FROM STANDARD	30
3.4 TEST SETUP	30
3.5 EUT OPERATION CONDITIONS	30
3.6 TEST RESULTS	31
4 . 26DB & 99% EMISSION BANDWIDTH	32
4.1 APPLIED PROCEDURES / LIMIT	32
4.2 TEST PROCEDURE	32
4.3 EUT OPERATION CONDITIONS	33
4.4 TEST RESULTS	33

Table of Contents

	Page
5 . MINIMUM 6 DB BANDWIDTH	34
5.1 APPLIED PROCEDURES / LIMIT	34
5.2 TEST PROCEDURE	34
5.3 DEVIATION FROM STANDARD	34
5.4 TEST SETUP	34
5.5 EUT OPERATION CONDITIONS	34
5.6 TEST RESULTS	35
6 . MAXIMUM CONDUCTED OUTPUT POWER	36
6.1 PPLIED PROCEDURES / LIMIT	36
6.2 TEST RESULTS	38
7 . OUT OF BAND EMISSIONS	39
7.1 APPLICABLE STANDARD	39
7.2 TEST PROCEDURE	40
7.3 DEVIATION FROM STANDARD	40
7.4 TEST SETUP	40
7.5 EUT OPERATION CONDITIONS	40
7.6 TEST RESULTS	41
8. FREQUENCY STABILITY MEASUREMENT	42
8.1 LIMIT	42
8.2 TEST PROCEDURES	42
8.3 TEST SETUP LAYOUT	42
8.4 EUT OPERATION DURING TEST	42
8.5 TEST RESULTS	43
9. ANTENNA REQUIREMENT	46
9.1 STANDARD REQUIREMENT	46
9.2 EUT ANTENNA	46
10. TEST RESULTS	47
10.1 DUTY CYCLE	47
10.2 MAXIMUM CONDUCTED OUTPUT POWER	52
10.3 OCCUPIED CHANNEL BANDWIDTH	53
10.4 MAXIMUM POWER SPECTRAL DENSITY LEVEL	62
10.5 BAND EDGE	67
10.5 CONDUCTED RF SPURIOUS EMISSION	70

Revision History

Report No.	Version	Description	Issued Date
S22062206002004	Rev.01	Initial issue of report	11 Jul. 2022

1. SUMMARY OF TEST RESULTS

Test procedures according to the technical standards:

FCC Part15 (15.407) , Subpart E			
Standard Section	Test Item	Judgment	Remark
15.207	AC Power Line Conducted Emissions	PASS	
15.209(a), 15.407 (b)(1) 15.407 (b)(4) 15.407 (b)(6)	Spurious Radiated Emissions	PASS	
15.407 (a)(1) 15.407 (a)(3)	26 dB and 99% Emission Bandwidth	PASS	
15.407(e)	Minimum 6 dB bandwidth	N/A	
15.407 (a)(1) 15.407 (a)(3)	Maximum Conducted Output Power	PASS	
15.407(b)(1) 15.407(b)(4)	Band Edge	PASS	
15.407 (a)(1) 15.407 (a)(3)	Power Spectral Density	PASS	
15.407(b)	Spurious Emissions at Antenna Terminals	PASS	
15.203	Antenna Requirement	PASS	
15.407(c)	Automatically discontinue transmission	PASS	

NOTE:

(1) "N/A" denotes test is not applicable in this Test Report

1.1 FACILITIES AND ACCREDITATIONS

FACILITIES

All measurement facilities used to collect the measurement data are located at 1/F, Building E, Fenda Science Park Sanwei, Xixiang, Bao'an District Shenzhen, Guangdong, China

The sites are constructed in conformance with the requirements of ANSI C63.7, ANSI C63.10 and CISPR Publication 22.

LABORATORY ACCREDITATIONS AND LISTINGS

Site Description

CNAS-Lab. : The Certificate Registration Number is L5516.

IC-Registration : The Certificate Registration Number is 9270A.
CAB identifier:CN0074

FCC- Accredited : Test Firm Registration Number: 463705.
Designation Number: CN1184

A2LA-Lab. : The Certificate Registration Number is 4298.01

Name of Firm : Shenzhen NTEK Testing Technology Co., Ltd.

Site Location : 1/F, Building E, Fenda Science Park Sanwei, Xixiang, Bao'an District
Shenzhen, Guangdong, China

1.2 MEASUREMENT UNCERTAINTY

The reported uncertainty of measurement $y \pm U$, where expended uncertainty U is based on a standard uncertainty multiplied by a coverage factor of $k=2$, providing a level of confidence of approximately 95 %.

No.	Item	Uncertainty
1	Conducted Emission Test	$\pm 2.80\text{dB}$
2	RF power, conducted	$\pm 0.16\text{dB}$
3	Spurious emissions, conducted	$\pm 0.21\text{dB}$
4	All emissions, radiated(30MHz~1GHz)	$\pm 2.64\text{dB}$
5	All emissions, radiated(1GHz~6GHz)	$\pm 2.40\text{dB}$
6	All emissions, radiated(> 6GHz)	$\pm 2.52\text{dB}$
7	Temperature	$\pm 0.5^\circ\text{C}$
8	Humidity	$\pm 2\%$

1. GENERAL INFORMATION

1.1 GENERAL DESCRIPTION OF EUT

Equipment	PROJECTOR														
Trade Mark	N/A														
Model Name	Q6-2														
Family Model	Q6-5,Q6-6,Q6-8,Q6-9														
Model Difference	All models are the same circuit and RF module, except the Model name.														
FCC ID	2A3DJ-Q6														
Product Description	<table border="1"> <tr> <td>Mode Supported</td> <td> <input checked="" type="checkbox"/>802.11a <input checked="" type="checkbox"/>802.11n(HT20) <input checked="" type="checkbox"/>802.11n(HT40) </td> </tr> <tr> <td>Data Rate</td> <td>802.11a: 6,9,12,18,24,36,48,54Mbps; 802.11n(HT20/HT40):MCS0-MCS15;</td> </tr> <tr> <td>Modulation</td> <td>OFDM with BPSK/QPSK/16QAM/64QAM</td> </tr> <tr> <td>Operating Frequency Range</td> <td> <input checked="" type="checkbox"/> U-NII-1: 5150 MHz ~5250MHz <input type="checkbox"/> U-NII-2A: 5250MHz~5350MHz <input type="checkbox"/> U-NII-2C: 5470MHz~5725MHz <input type="checkbox"/> U-NII-3: 5725 MHz ~5850 MHz </td> </tr> <tr> <td>Function:</td> <td> <input type="checkbox"/>Outdoor AP <input type="checkbox"/>Indoor AP <input type="checkbox"/>Fixed P2P(for U-NII-1, U-NII-3) <input checked="" type="checkbox"/>Client(for U-NII-1, U-NII-3) </td> </tr> <tr> <td>Antenna Type</td> <td>FPCB Antenna</td> </tr> <tr> <td>Antenna Gain</td> <td>2dBi</td> </tr> </table> <p>Based on the application, features, or specification exhibited in User's Manual, More details of EUT technical specification, please refer to the User's Manual.</p>	Mode Supported	<input checked="" type="checkbox"/> 802.11a <input checked="" type="checkbox"/> 802.11n(HT20) <input checked="" type="checkbox"/> 802.11n(HT40)	Data Rate	802.11a: 6,9,12,18,24,36,48,54Mbps; 802.11n(HT20/HT40):MCS0-MCS15;	Modulation	OFDM with BPSK/QPSK/16QAM/64QAM	Operating Frequency Range	<input checked="" type="checkbox"/> U-NII-1: 5150 MHz ~5250MHz <input type="checkbox"/> U-NII-2A: 5250MHz~5350MHz <input type="checkbox"/> U-NII-2C: 5470MHz~5725MHz <input type="checkbox"/> U-NII-3: 5725 MHz ~5850 MHz	Function:	<input type="checkbox"/> Outdoor AP <input type="checkbox"/> Indoor AP <input type="checkbox"/> Fixed P2P(for U-NII-1, U-NII-3) <input checked="" type="checkbox"/> Client(for U-NII-1, U-NII-3)	Antenna Type	FPCB Antenna	Antenna Gain	2dBi
	Mode Supported	<input checked="" type="checkbox"/> 802.11a <input checked="" type="checkbox"/> 802.11n(HT20) <input checked="" type="checkbox"/> 802.11n(HT40)													
	Data Rate	802.11a: 6,9,12,18,24,36,48,54Mbps; 802.11n(HT20/HT40):MCS0-MCS15;													
	Modulation	OFDM with BPSK/QPSK/16QAM/64QAM													
	Operating Frequency Range	<input checked="" type="checkbox"/> U-NII-1: 5150 MHz ~5250MHz <input type="checkbox"/> U-NII-2A: 5250MHz~5350MHz <input type="checkbox"/> U-NII-2C: 5470MHz~5725MHz <input type="checkbox"/> U-NII-3: 5725 MHz ~5850 MHz													
	Function:	<input type="checkbox"/> Outdoor AP <input type="checkbox"/> Indoor AP <input type="checkbox"/> Fixed P2P(for U-NII-1, U-NII-3) <input checked="" type="checkbox"/> Client(for U-NII-1, U-NII-3)													
	Antenna Type	FPCB Antenna													
	Antenna Gain	2dBi													
	Power supply	AC 100-240V, 50/60Hz, 75W Max.													
	Adapter	N/A													
Connecting I/O Port(s)	Please refer to the User's Manual														
HW Version	2800-A53F03-01 V6														
SW Version	V6BK530431080P20211118														

Note:

1. For a more detailed features description, please refer to the manufacturer's specifications or the User's Manual.
2. Frequency and Channel list:

Band	20MHz		40MHz	
	Channel	Frequency	Channel	Frequency
U-NII-1	36	5180 MHz	38	5190 MHz
	40	5200 MHz	46	5230 MHz
	44	5220 MHz		
	48	5240 MHz		

1.2 DESCRIPTION OF TEST MODES

To investigate the maximum EMI emission characteristics generates from EUT, the test system was pre-scanning tested base on the consideration of following EUT operation mode or test configuration mode which possible have effect on EMI emission level. Each of these EUT operation mode(s) or test configuration mode(s) mentioned above was evaluated respectively.

For Radiated Emission	
Final Test Mode	Description
Mode 1	Normal Link Mode
Mode 2	802.11a / n CH36/ CH40/CH48
Mode 3	802.11n40 CH38/CH46

For Conducted Emission	
Final Test Mode	Description
Mode 1	Normal Link Mode
Mode 2	802.11a / n CH36/ CH40/CH48
Mode 3	802.11n40 CH38/CH46

Note:

- (1) The measurements are performed at the highest, middle, lowest available channels.
- (2) The measurements are performed at all Bit Rate of Transmitter, the worst data was reported

1.3 BLOCK DIGRAM SHOWING THE CONFIGURATION OF SYSTEM TESTED

For AC Conducted Emission Mode



For Radiated Test Cases



For Conducted Test Cases

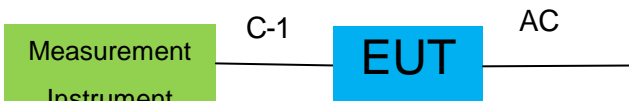

Note: 1. The temporary antenna connector is soldered on the PCB board in order to perform conducted tests and this temporary antenna connector is listed in the equipment list.

1.4 DESCRIPTION OF SUPPORT UNITS(CONDUCTED MODE)

The EUT has been tested as an independent unit together with other necessary accessories or support units. The following support units or accessories were used to form a representative test configuration during the tests.

Item	Equipment	Model/Type No.	Series No.	Note

Item	Cable Type	Shielded Type	Ferrite Core	Length
C-1	RF Cable	YES	NO	0.1m

Note:

- (1) The support equipment was authorized by Declaration of Confirmation.
- (2) For detachable type I/O cable should be specified the length in cm in 『Length』 column.
- (3) During the battery power test, the battery is fully charged.

1.5 EQUIPMENTS LIST FOR ALL TEST ITEMS

Radiation& Conducted Test equipment

Item	Kind of Equipment	Manufacturer	Type No.	Serial No.	Last calibration	Calibrated until	Calibration period
1	Spectrum Analyzer	Agilent	E4407B	MY45108040	2022.04.06	2023.04.05	1 year
2	Spectrum Analyzer	Agilent	N9020A	MY49100060	2021.07.01 2022.06.16	2022.06.30 2023.06.15	1 year
3	Spectrum Analyzer	R&S	FSV40	101417	2021.07.01 2022.06.16	2022.06.30 2023.06.15	1 year
4	Test Receiver	R&S	ESPI7	101318	2022.04.06	2023.04.05	1 year
5	Bilog Antenna	TESEQ	CBL6111D	31216	2022.03.30	2023.03.29	1 year
6	50Ω Coaxial Switch	Anritsu	MP59B	6200983705	2020.05.11	2023.05.10	3 year
7	Horn Antenna	EM	EM-AH-1018 0	2011071402	2022.03.31	2023.03.30	1 year
8	Broadband Horn Antenna	SCHWARZBECK	BBHA 9170	803	2021.11.07	2022.11.06	1 year
9	Amplifier	EMC	EMC051835 SE	980246	2021.07.01 2022.06.17	2022.06.30 2023.06.16	1 year
10	Active Loop Antenna	SCHWARZBECK	FMZB 1519 B	055	2021.11.07	2022.11.06	1 year
11	Power Meter	DARE	RPR3006W	15100041SN O84	2021.07.01 2022.06.16	2022.06.30 2023.06.15	1 year
12	Test Cable (9KHz-30MHz)	N/A	R-01	N/A	2019.08.06	2022.08.05	3 year
13	Test Cable (30MHz-1GHz)	N/A	R-02	N/A	2019.08.06	2022.08.05	3 year
14	High Test Cable(1G-40G Hz)	N/A	R-03	N/A	2019.06.28 2022.06.17	2022.06.27 2023.06.16	3 year
15	High Test Cable(1G-40G Hz)	N/A	R-04	N/A	2019.08.06	2022.08.05	3 year
16	Filter	TRILTHIC	2400MHz	29	2020.04.07	2023.04.06	1 year
17	temporary antenna connector (Note)	NTS	R001	N/A	N/A	N/A	N/A

Note:

We will use the temporary antenna connector (soldered on the PCB board) When conducted test
And this temporary antenna connector is listed within the instrument list

AC Conduction Test equipment

Item	Kind of Equipment	Manufacturer	Type No.	Serial No.	Last calibration	Calibrated until	Calibration period
1	Test Receiver	R&S	ESCI	101160	2022.04.06	2023.04.05	1 year
2	LISN	R&S	ENV216	101313	2022.04.06	2023.04.05	1 year
3	LISN	SCHWARZBECK	NNLK 8129	8129245	2022.04.06	2023.04.05	1 year
4	50Ω Coaxial Switch	ANRITSU CORP	MP59B	6200983704	2020.05.11	2023.05.10	3 year
5	Test Cable (9KHz-30MHz)	N/A	C01	N/A	2020.05.11	2023.05.10	3 year
6	Test Cable (9KHz-30MHz)	N/A	C02	N/A	2020.05.11	2023.05.10	3 year
7	Test Cable (9KHz-30MHz)	N/A	C03	N/A	2020.05.11	2023.05.10	3 year

Note: Each piece of equipment is scheduled for calibration once a year except the Test Cable& Aux Equipment which is scheduled for calibration every 3 years.

2. EMC EMISSION TEST

2.1 CONDUCTED EMISSION MEASUREMENT

2.1.1 APPLICABLE STANDARD

According to FCC Part 15.207(a)

2.1.2 CONFORMANCE LIMIT

Frequency(MHz)	Conducted Emission Limit	
	Quasi-peak	Average
0.15-0.5	66-56*	56-46*
0.5-5.0	56	46
5.0-30.0	60	50

Note: 1. *Decreases with the logarithm of the frequency
 2. The lower limit shall apply at the transition frequencies
 3. The limit decreases in line with the logarithm of the frequency in the range of 0.15 to 0.50MHz.

2.1.3 TEST CONFIGURATION

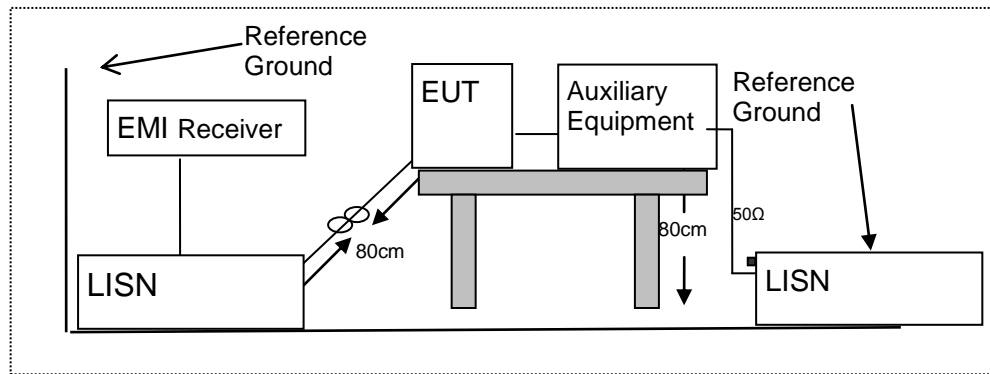

2.1.4 TEST PROCEDURE

According to the requirements in Section 13.1.4.1 of ANSI C63.10-2013 Conducted emissions the EUT measured in the frequency range between 0.15 MHz and 30 MHz using CISPR Quasi-Peak and average detector mode.

1. The EUT was placed 0.4 meter from the conducting wall of the shielding room.
2. The EUT was placed on a table which is 0.8m above ground plane.
3. Connect EUT to the power mains through a line impedance stabilization network (LISN). All other support equipments powered from additional LISN(s). The LISN provide 50 Ohm/ 50uH of coupling impedance for the measuring instrument.
4. Interconnecting cables that hang closer than 40 cm to the ground plane shall be folded back and forth in the center forming a bundle 30 to 40cm long.
5. I/O cables that are not connected to a peripheral shall be bundled in the center. The end of the cable may be terminated, if required, using the correct terminating impedance. The overall length shall not exceed 1 m.
6. LISN at least 80 cm from nearest part of EUT chassis.
7. The frequency range from 150KHz to 30MHz was searched.
8. Set the test-receiver system to Peak Detect Function and specified bandwidth(IF bandwidth=9KHz) with Maximum Hold Mode
9. For the actual test configuration, please refer to the related Item –EUT Test Photos.

EUT :	PROJECTOR	Model Name. :	Q6-2
Temperature :	26 °C	Relative Humidity :	56%
Pressure :	1010hPa	Phase :	L
Test Voltage :	AC 120V/60Hz	Test Mode :	Mode 1(5.2G)

Frequency (MHz)	Reading Level (dBμV)	Correct Factor (dB)	Measure-ment (dBμV)	Limits (dBμV)	Margin (dB)	Remark
0.1539	47.94	9.60	57.54	65.78	-8.24	QP
0.1539	30.66	9.60	40.26	55.78	-15.52	AVG
0.1780	46.34	9.61	55.95	64.57	-8.62	QP
0.1780	28.85	9.61	38.46	54.57	-16.11	AVG
0.5580	35.60	9.67	45.27	56.00	-10.73	QP
0.5580	21.00	9.67	30.67	46.00	-15.33	AVG
0.8420	35.52	9.68	45.20	56.00	-10.80	QP
0.8420	20.09	9.68	29.77	46.00	-16.23	AVG
1.3180	35.55	9.68	45.23	56.00	-10.77	QP
1.3180	20.14	9.68	29.82	46.00	-16.18	AVG
25.6980	29.61	10.30	39.91	60.00	-20.09	QP
25.6980	15.59	10.30	25.89	50.00	-24.11	AVG

Remark:

1. All readings are Quasi-Peak and Average values.
2. Factor = Insertion Loss + Cable Loss.

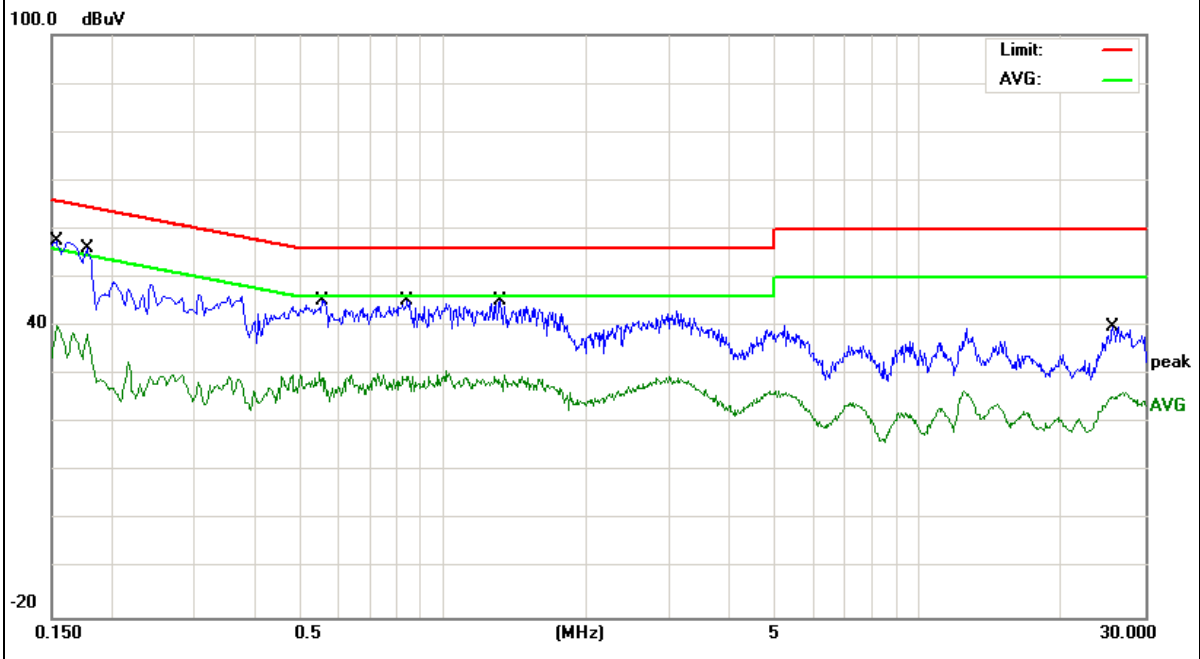

EUT :	PROJECTOR	Model Name. :	Q6-2
Temperature :	26 °C	Relative Humidity :	56%
Pressure :	1010hPa	Phase :	N
Test Voltage :	AC 120V/60Hz	Test Mode :	Mode 1(5.2G)

Frequency (MHz)	Reading Level (dBμV)	Correct Factor (dB)	Measure-ment (dBμV)	Limits (dBμV)	Margin (dB)	Remark
0.1539	48.94	9.65	58.59	65.78	-7.19	QP
0.1539	31.41	9.65	41.06	55.78	-14.72	AVG
0.1700	46.82	9.65	56.47	64.96	-8.49	QP
0.1700	26.31	9.65	35.96	54.96	-19.00	AVG
0.3780	37.55	9.66	47.21	58.32	-11.11	QP
0.3780	21.95	9.66	31.61	48.32	-16.71	AVG
0.5620	37.08	9.67	46.75	56.00	-9.25	QP
0.5620	22.33	9.67	32.00	46.00	-14.00	AVG
1.0220	37.35	9.69	47.04	56.00	-8.96	QP
1.0220	22.32	9.69	32.01	46.00	-13.99	AVG
29.5300	30.92	10.26	41.18	60.00	-18.82	QP
29.5300	16.66	10.26	26.92	50.00	-23.08	AVG

Remark:

1. All readings are Quasi-Peak and Average values.
2. Factor = Insertion Loss + Cable Loss.

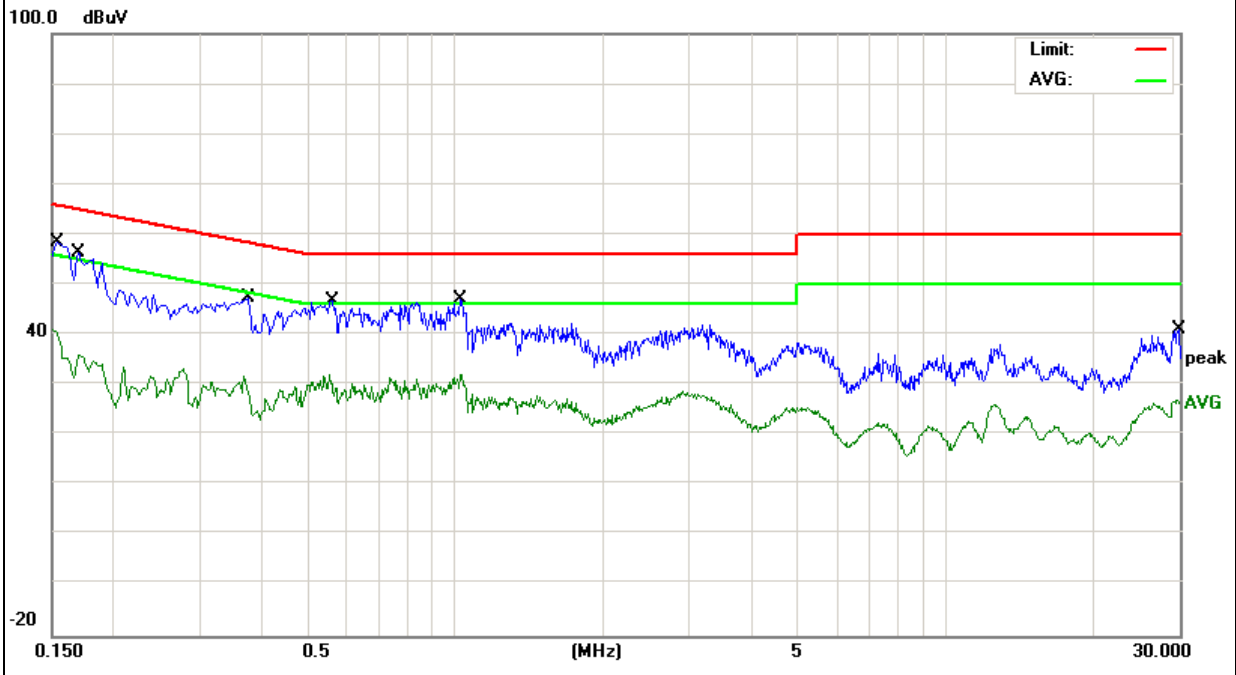

2.2 RADIATED EMISSION MEASUREMENT

2.2.1 APPLICABLE STANDARD

According to FCC Part 15.407(d) and 15.209

2.2.2 CONFORMANCE LIMIT

According to FCC Part 15.407(b)(7): radiated emissions which fall in the restricted bands, as defined in §15.205(a), must also comply with the radiated emission limits specified in §15.209(a) (see §15.205(c)). According to FCC Part 15.205, Restricted bands

MHz	MHz	MHz	GHz
0.090-0.110	16.42-16.423	399.9-410	4.5-5.15
0.495-0.505	16.69475-16.69525	608-614	5.35-5.46
2.1735-2.1905	16.80425-16.80475	960-1240	7.25-7.75
4.125-4.128	25.5-25.67	1300-1427	8.025-8.5
4.17725-4.17775	37.5-38.25	1435-1626.5	9.0-9.2
4.20725-4.20775	73-74.6	1645.5-1646.5	9.3-9.5
6.215-6.218	74.8-75.2	1660-1710	10.6-12.7
6.26775-6.26825	123-138	2200-2300	14.47-14.5
8.291-8.294	149.9-150.05	2310-2390	15.35-16.2
8.362-8.366	156.52475-156.52525	2483.5-2500	17.7-21.4
8.37625-8.38675	156.7-156.9	2690-2900	22.01-23.12
8.41425-8.41475	162.0125-167.17	3260-3267	23.6-24.0
12.29-12.293	167.72-173.2	3332-3339	31.2-31.8
12.51975-12.52025	240-285	3345.8-3358	36.43-36.5
12.57675-12.57725	322-335.4	3600-4400	(2)
13.36-13.41			

20dBc in any 100 kHz bandwidth outside the operating frequency band. In case the emission fall within the restricted band specified on 15.205(a), then the 15.209(a) limit in the table below has to be followed.

Restricted Frequency(MHz)	Field Strength ($\mu\text{V/m}$)	Field Strength ($\text{dB}\mu\text{V/m}$)	Measurement Distance
0.009~0.490	2400/F(KHz)	20 log ($\mu\text{V/m}$)	300
0.490~1.705	24000/F(KHz)	20 log ($\mu\text{V/m}$)	30
1.705~30.0	30	29.5	30
30-88	100	40	3
88-216	150	43.5	3
216-960	200	46	3
Above 960	500	54	3

Limits of Radiated Emission Measurement(Above 1000MHz)

Frequency(MHz)	Class B ($\text{dB}\mu\text{V/m}$) (at 3M)	
	PEAK	AVERAGE
Above 1000	74	54

Remark :1. Emission level in $\text{dB}\mu\text{V/m}=20 \log (\mu\text{V/m})$
 2. Measurement was performed at an antenna to the closed point of EUT distance of meters.
 3. For Frequency 9kHz~30MHz:
 Distance extrapolation factor = $40\log(\text{Specific distance/ test distance})(\text{dB})$;
 Limit line=Specific limits($\text{dB}\mu\text{V}$) + distance extrapolation factor.
 For Frequency above 30MHz:
 Distance extrapolation factor = $20\log(\text{Specific distance/ test distance})(\text{dB})$;
 Limit line=Specific limits($\text{dB}\mu\text{V}$) + distance extrapolation factor.

2.2.3 MEASURING INSTRUMENTS

The Measuring equipment is listed in the section 6.3 of this test report.

2.2.4 TEST CONFIGURATION

(a) For radiated emissions below 30MHz

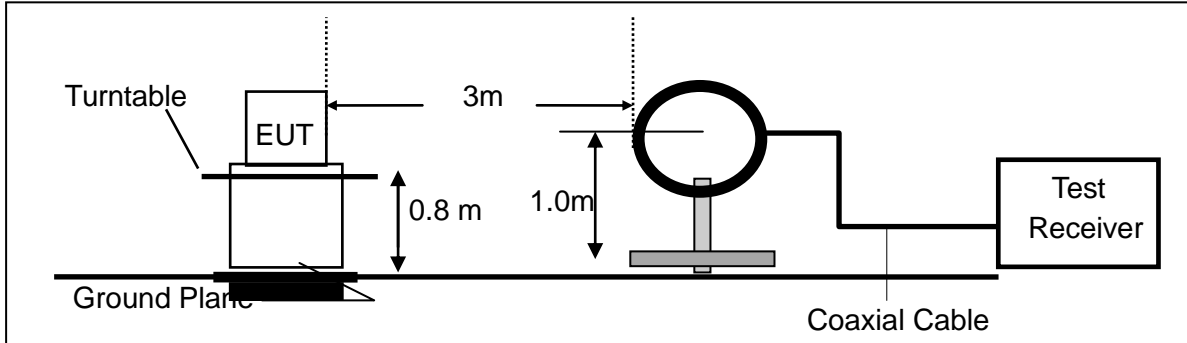

(b) For radiated emissions from 30MHz to 1000MHz

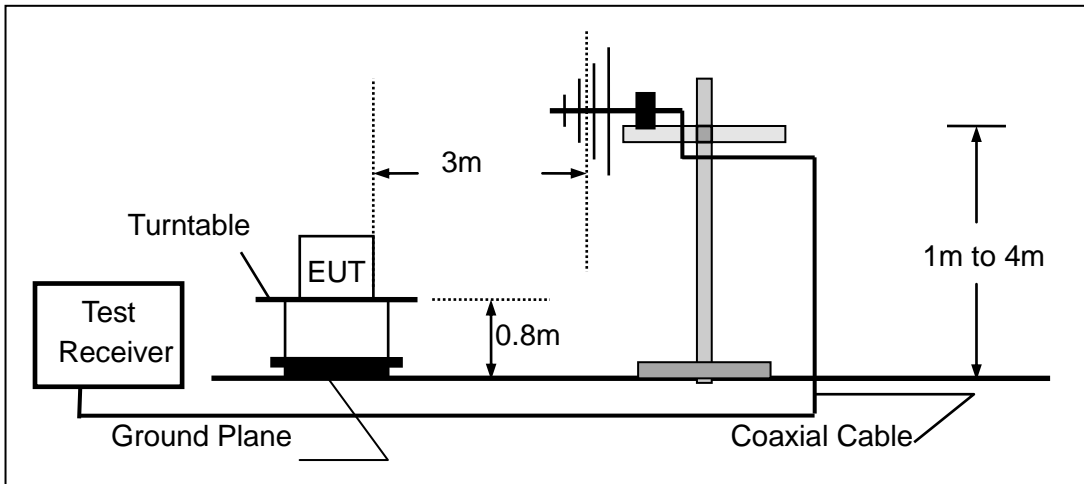

(c) For radiated emissions above 1000MHz

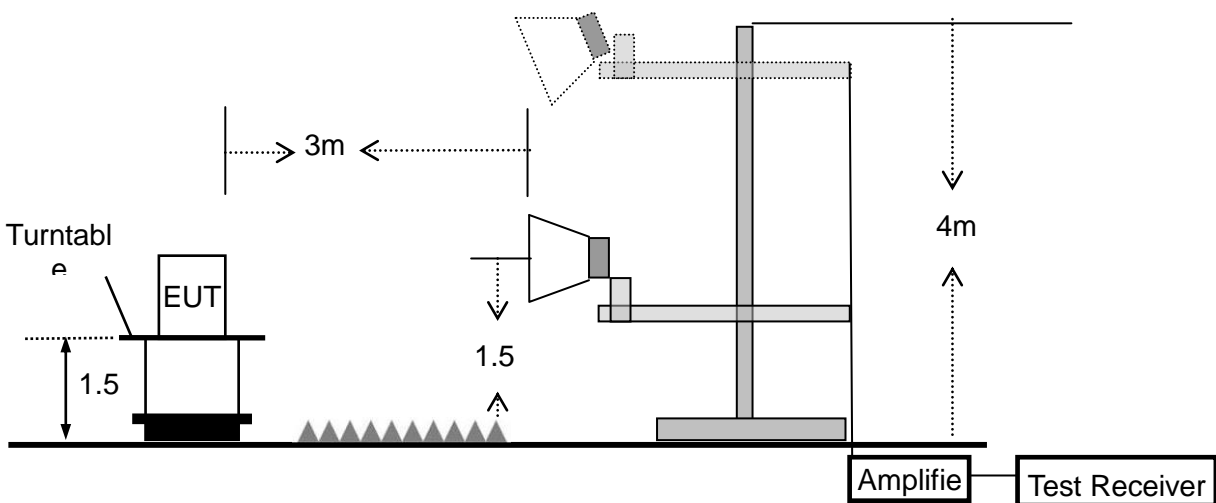

2.2.5 TEST PROCEDURE

The test site semi-anechoic chamber has met the requirement of NSA tolerance 4 dB according to the standards: ANSI C63.10-2013. The test distance is 3m. The setup is according to the requirements in Section 13.1.4.1 of ANSI C63.10-2013 and CAN/CSA-CEI/IEC CISPR 22.

This test is required for any spurious emission that falls in a Restricted Band, as defined in Section 15.205. It must be performed with the highest gain of each type of antenna proposed for use with the EUT.

Use the following spectrum analyzer settings:

Spectrum Parameter	Setting
Attenuation	Auto
Start Frequency	1000 MHz
Stop Frequency	10th carrier harmonic
RB / VB (emission in restricted band)	1 MHz / 1 MHz for Peak, 1 MHz / 10Hz for Average

Receiver Parameter	Setting
Attenuation	Auto
Start ~ Stop Frequency	9kHz~150kHz / RB 200Hz for QP
Start ~ Stop Frequency	150kHz~30MHz / RB 9kHz for QP
Start ~ Stop Frequency	30MHz~1000MHz / RB 120kHz for QP

- The measuring distance of at 3 m shall be used for measurements at frequency up to 1GHz. For frequencies above 1GHz, any suitable measuring distance may be used.
- The EUT was placed on the top of a rotating table 0.8 m for below 1GHz and 1.5m for above 1GHz the ground at a 3 meter. The table was rotated 360 degrees to determine the position of the highest radiation.
- The height of the equipment or of the substitution antenna shall be 0.8 m for below 1GHz and 1.5m for above 1GHz; the height of the test antenna shall vary between 1 m to 4 m. Both horizontal and vertical polarizations of the antenna are set to make the measurement.
- The initial step in collecting conducted emission data is a spectrum analyzer peak detector mode pre-scanning the measurement frequency range. Significant peaks are then marked and then Quasi Peak detector mode re-measured.
- If the Peak Mode measured value compliance with and lower than Quasi Peak Mode Limit, the EUT shall be deemed to meet QP Limits and then no additional QP Mode measurement performed.
- For the actual test configuration, please refer to the related Item –EUT Test Photos.

Note:

Both horizontal and vertical antenna polarities were tested and performed pretest to three orthogonal axis. The worst case emissions were reported

During the radiated emission test, the Spectrum Analyzer was set with the following configurations:

Frequency Band (MHz)	Function	Resolution bandwidth	Video Bandwidth
30 to 1000	QP	120 kHz	300 kHz
Above 1000	Peak	1 MHz	1 MHz
	Average	1 MHz	10 Hz

Note: for the frequency ranges below 30 MHz, a narrower RBW is used for these ranges but the measured value should add a RBW correction factor (RBWCF) where $RBWCF [dB] = 10 \cdot \lg(100 [kHz] / \text{narrower RBW [kHz]})$. , the narrower RBW is 1 kHz and RBWCF is 20 dB for the frequency 9 kHz to 150 kHz, and the narrower RBW is 10 kHz and RBWCF is 10 dB for the frequency 150 kHz to 30 MHz.

2.2.6 TEST RESULTS (9KHZ – 30 MHZ)

EUT :	PROJECTOR	Model Name :	Q6-2
Temperature :	26 °C	Relative Humidity :	54%
Pressure:	1010 hPa	Test Voltage :	AC 120V/60Hz
Test Mode :	TX	Polarization :	--

Freq.	Reading	Limit	Margin	State
(MHz)	(dBuV/m)	(dBuV/m)	(dB)	P/F
--	--	--	--	N/A
--	--	--	--	N/A

NOTE:

The amplitude of spurious emissions which are attenuated by more than 20dB below the permissible value has no need to be reported.

2.2.7 TEST RESULTS (30MHZ – 1GHZ)

EUT :	PROJECTOR	Model Name :	Q6-2
Temperature :	26 °C	Relative Humidity :	54%
Pressure :	1010 hPa	Test Voltage :	AC 120V/60Hz
Test Mode :	TX(5.2G)- 802.11a (Low CH)		

Polar (H/V)	Frequency	Meter Reading	Factor	Emission Level	Limits	Margin	Remark
	(MHz)	(dBuV)	(dB)	(dBuV/m)	(dBuV/m)	(dB)	
V	30.4237	13.28	26.11	39.39	40.00	-0.61	QP
V	38.2120	17.23	22.07	39.30	40.00	-0.70	QP
V	42.6000	19.30	19.15	38.45	40.00	-1.55	QP
V	166.6514	24.30	17.25	41.55	43.50	-1.95	QP
V	396.2414	19.78	22.75	42.53	46.00	-3.47	QP
V	771.4486	12.66	27.86	40.52	46.00	-5.48	QP

Remark:

Emission Level= ReadingLevel+ Factor, Margin= Emission Level - Limit

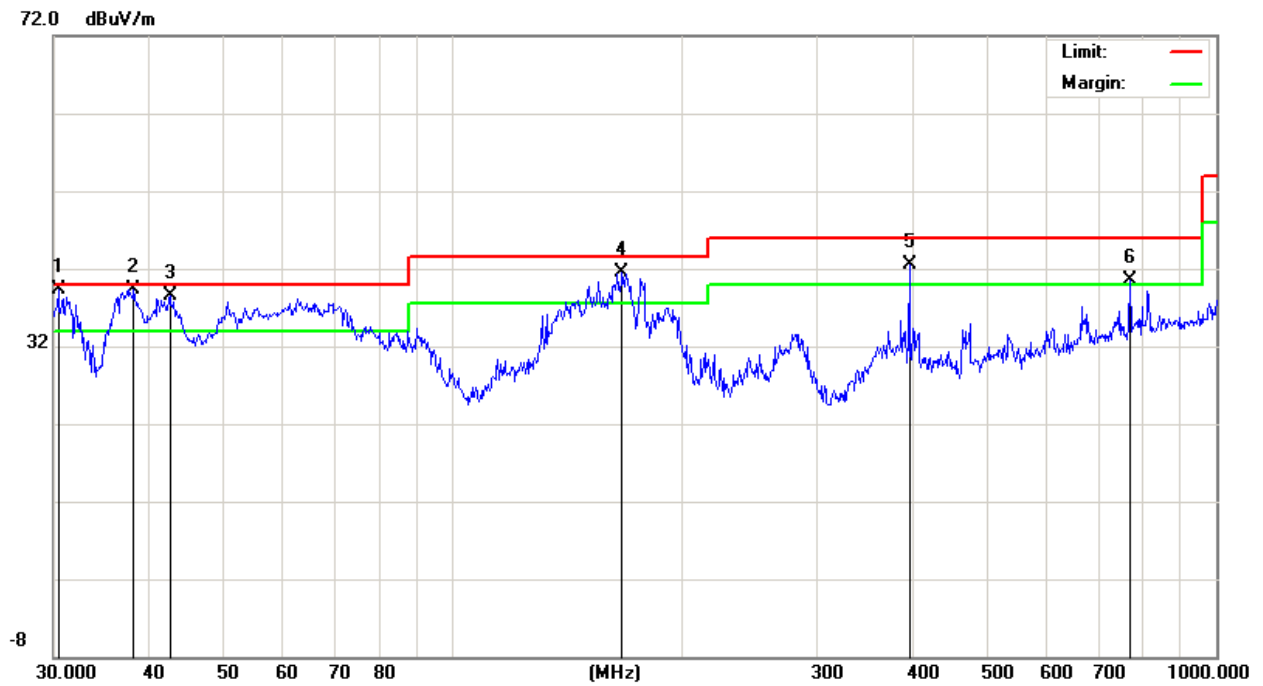

Polar (H/V)	Frequency	Meter Reading	Factor	Emission Level	Limits	Margin	Remark
	(MHz)	(dBuV)	(dB)	(dBuV/m)	(dBuV/m)	(dB)	
H	77.8653	23.80	15.32	39.12	40.00	-0.88	QP
H	169.5990	25.60	17.35	42.95	43.50	-0.55	QP
H	287.9904	20.56	19.81	40.37	46.00	-5.63	QP
H	397.6333	19.89	22.75	42.64	46.00	-3.36	QP
H	475.4991	17.08	23.69	40.77	46.00	-5.23	QP
H	813.1115	11.04	28.64	39.68	46.00	-6.32	QP

Remark:

Emission Level= ReadingLevel+ Factor, Margin= Emission Level - Limit

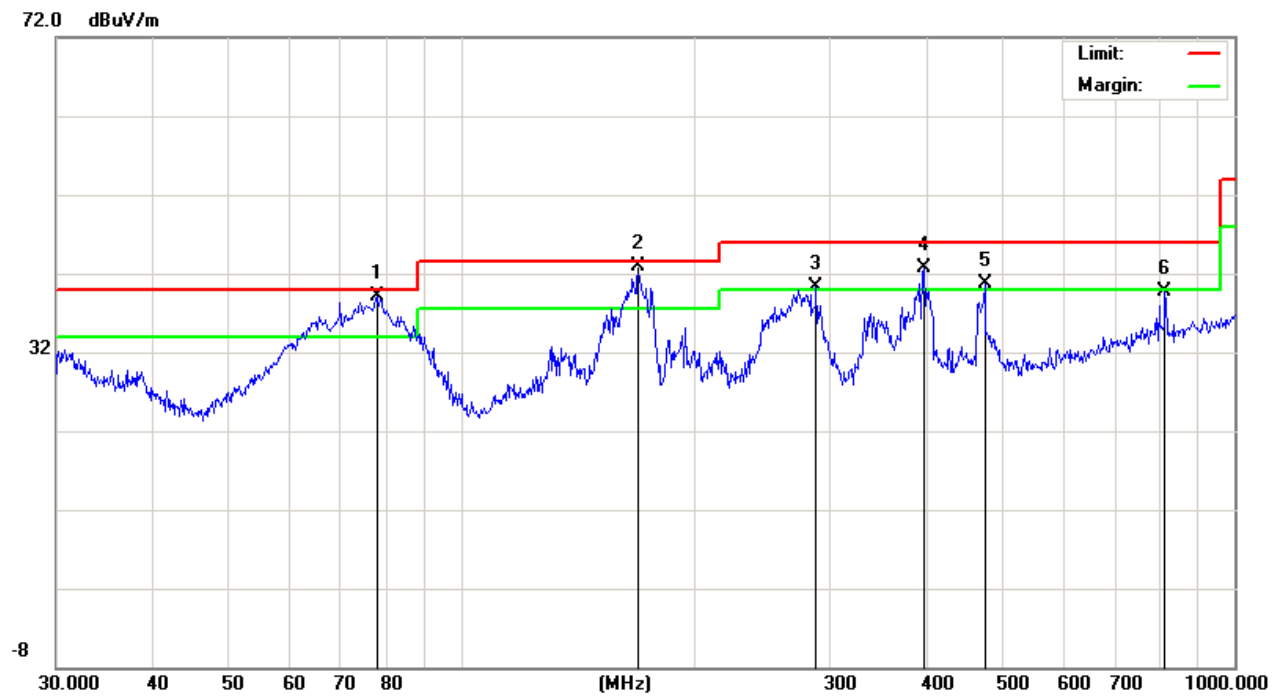

Note: All modes have been tested, just the the worst mode has been recorded in the report.

2.2.8 TEST RESULTS (1GHz-18GHz)

EUT :	PROJECTOR	Model Name. :	Q6-2
Temperature :	20 °C	Relative Humidity :	48%
Pressure :	1010 hPa	Test Voltage :	AC 120V/60Hz
Test Mode :	TX(5.2G) - 802.11a_5180~5240MHz		

Polar	Frequency	Meter Reading	Cable loss	Antenna Factor	Preamp Factor	Emission Level	Limits	Margin	Detector Type
(H/V)	(MHz)	(dBuV)	(dB)	dB/m	(dB)	(dBuV/m)	(dBuV/m)	(dB)	
Low Channel (5180 MHz)-Above 1G									
Vertical	3694.92	61.91	5.94	35.4	44	59.25	74	-14.75	Pk
Vertical	3694.7	43.1	5.94	35.4	44	40.44	54	-13.56	AV
Vertical	10360.75	58.79	8.46	39.75	44.5	62.5	68.2	-5.7	Pk
Vertical	15540.75	61.5	10.12	38.8	44.1	66.32	74	-7.68	Pk
Vertical	15540.51	40.2	10.12	38.8	42.7	46.42	54	-7.58	AV
Horizontal	3713.86	63.9	5.94	35.18	44	61.02	74	-12.98	Pk
Horizontal	3713.38	44.19	5.94	35.18	44	41.31	54	-12.69	AV
Horizontal	10361.11	59.38	8.46	38.71	44.5	62.05	68.2	-6.15	Pk
Horizontal	15540.79	57.84	10.12	38.38	44.1	62.24	74	-11.76	Pk
Horizontal	15541.28	41.34	10.12	38.38	44.1	45.74	54	-8.26	AV
middle Channel (5200 MHz)-Above 1G									
Vertical	3624.61	59	6.48	36.35	44.05	57.78	74	-16.22	Pk
Vertical	3624.89	43.79	6.48	36.35	44.05	42.57	54	-11.43	AV
Vertical	10400.63	60.64	8.47	37.88	44.51	62.48	68.2	-5.72	Pk
Vertical	15600.67	60.57	10.12	38.8	44.1	65.39	74	-8.61	Pk
Vertical	15600.47	39.98	10.12	38.8	42.7	46.2	54	-7.8	AV
Horizontal	4202.8	58.45	6.48	36.37	44.05	57.25	74	-16.75	Pk
Horizontal	4202.58	45.47	6.48	36.37	44.05	44.27	54	-9.73	AV
Horizontal	10400.83	62.29	8.47	38.64	44.5	64.9	68.2	-3.3	Pk
Horizontal	15601.47	60.62	10.12	38.38	44.1	65.02	74	-8.98	Pk
Horizontal	15601.02	41.78	10.12	38.38	44.1	46.18	54	-7.82	AV

High Channel (5240 MHz)-Above 1G									
Vertical	4598.29	64.81	7.1	37.24	43.5	65.65	74	-8.35	Pk
Vertical	4598.63	43.94	7.1	37.24	43.5	44.78	54	-9.22	AV
Vertical	10480.87	60.79	8.46	37.68	44.5	62.43	68.2	-5.77	Pk
Vertical	15720.73	62.09	10.12	38.8	44.1	66.91	74	-7.09	AV
Vertical	15720.74	40.78	10.12	38.8	42.7	47	54	-7	Pk
Horizontal	4589.85	61.61	7.1	37.24	43.5	62.45	74	-11.55	AV
Horizontal	4590.13	42.12	7.1	37.24	43.5	42.96	54	-11.04	Pk
Horizontal	10481.11	62.51	8.46	38.57	44.5	65.04	68.2	-3.16	AV
Horizontal	15720.82	60.34	10.12	38.38	44.1	64.74	74	-9.26	Pk
Horizontal	15720.79	43.5	10.12	38.38	44.1	47.9	54	-6.1	AV

Note: "802.11a (5G)" mode is the worst mode. PK value is lower than the Average value limit, So average didn't record.

The amplitude of spurious emissions that are attenuated by more than 20dB below the permissible value has no need to be reported.

Emission level (dBuV/m) = 20 log Emission level (uV/m).

Corrected Reading: Antenna Factor + Cable Loss + Read Level - Preamp Factor = Level.

2.2.10 TEST RESULTS (18GHz-40GHz)

EUT :	PROJECTOR	Model Name. :	Q6-2
Temperature :	20 °C	Relative Humidity :	48%
Pressure :	1010 hPa	Test Voltage :	AC 120V/60Hz
Test Mode :	TX (5.2G)-802.11a 5180MHz~5240MHz;		

All the modulation modes have been tested, and the worst result was report as below:
Low Channel (5180 MHz)-Above 1G

Horizontal

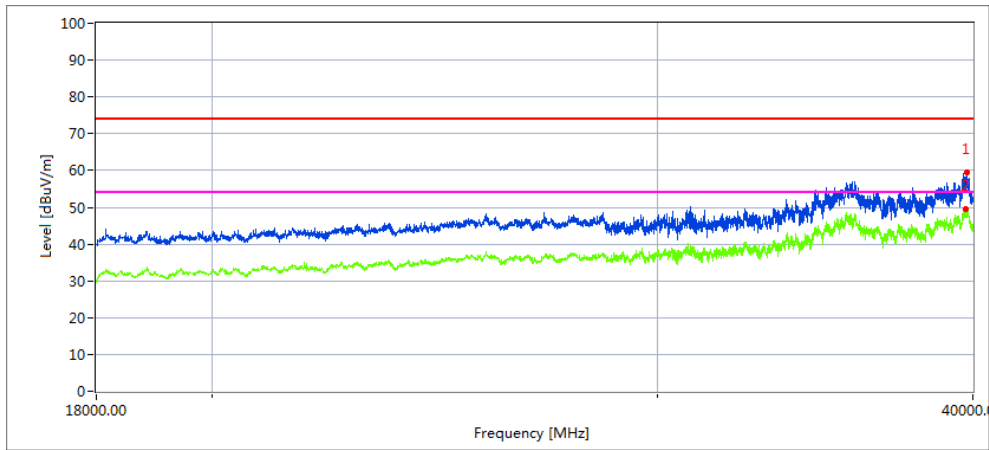

Frequency	Meter Reading	Cable loss	Antenna Factor	Preamp Factor	Emission Level	Limits	Margin	Remark
39769.32	39.58	20.09	44.07	43.48	60.26	68.2	7.94	Peak
39767.23	28.02	20.09	44.04	43.48	48.67	54	5.33	AVG

Vertical

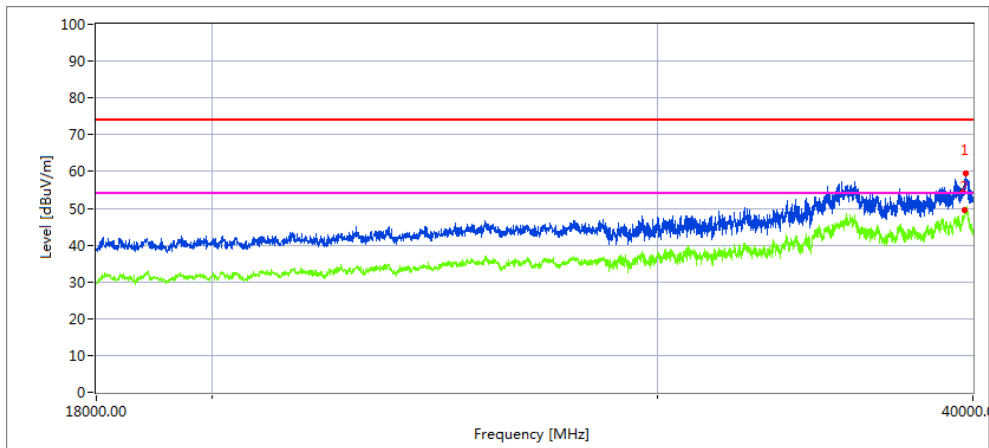

Frequency	Meter Reading	Cable loss	Antenna Factor	Preamp Factor	Emission Level	Limits	Margin	Remark
39769.62	32.39	20.09	44.07	43.48	53.07	56.32	3.25	Peak
39769.83	27.64	20.09	44.04	43.48	48.29	54	5.71	AVG

High Channel (5240 MHz)-Above 1G

Horizontal

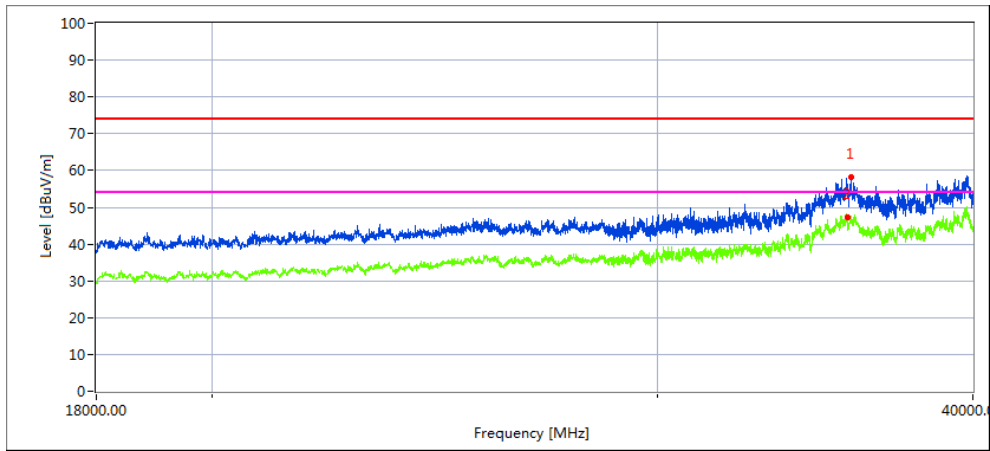

Frequency	Meter Reading	Cable loss	Antenna Factor	Preamp Factor	Emission Level	Limits	Margin	Remark
35628.4	41.18	19.11	42.73	44.61	58.41	68.2	9.79	Peak
35597.15	31.94	19.11	42.73	44.61	49.17	54	4.83	AVG

Vertical

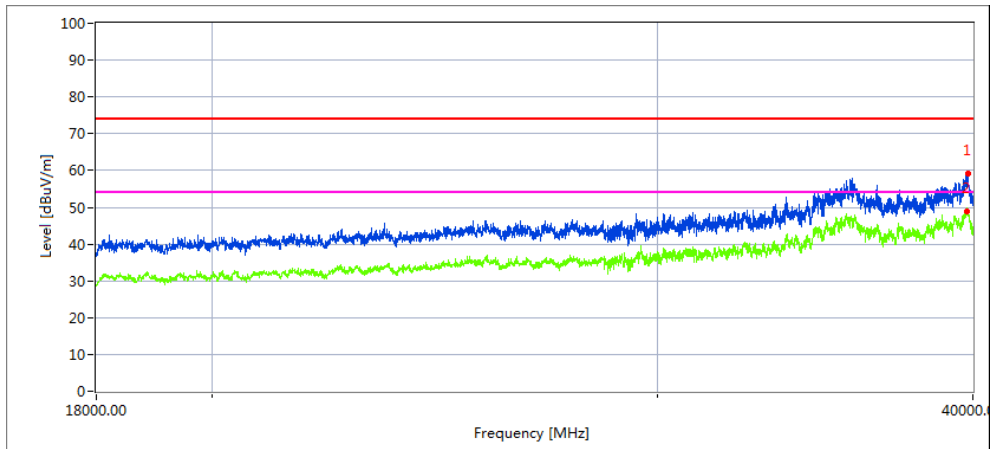

Frequency	Meter Reading	Cable loss	Antenna Factor	Preamp Factor	Emission Level	Limits	Margin	Remark
39769.53	37.68	20.09	44.07	43.48	58.36	68.2	9.84	Peak
39769.72	25.91	20.09	44.04	43.48	46.56	54	7.44	AVG

Note:802.11a mode is the worst mode.

2.2.10 Spurious Emission in Restricted Band 4.5GHz~5.150 GHz& 5.350GHz~5460GHz

EUT :	PROJECTOR	Model Name. :	Q6-2
Temperature :	20 °C	Relative Humidity :	48%
Pressure :	1010 hPa	Test Voltage :	AC 120V/60Hz
Test Mode :	TX (5.2G)-802.11a 5150MHz~5250MHz		

All the modulation modes have been tested, The report just record the worst data mode.

Frequency	Meter Reading	Cable Loss	Antenna Factor	Preamp Factor	Emission Level	Limits	Margin	Detector	Comment
(MHz)	(dBμV)	(dB)	dB/m	(dB)	(dBμV/m)	(dBμV/m)	(dB)	Type	
Low Channel (5180 MHz)									
4500	58.64	5.2	35.6	44.2	55.24	74	-18.76	Pk	Horizontal
4500	51.26	5.2	35.6	44.2	47.86	54	-6.14	AV	Horizontal
4500	63.48	5.2	35.6	44.2	60.08	74	-13.92	Pk	Horizontal
4500	46.78	5.2	35.6	44.2	43.38	54	-10.62	AV	Horizontal
5150	73.22	5.36	35.66	44.22	70.02	74	-3.98	Pk	Horizontal
5150	52.25	5.36	35.66	44.22	49.05	54	-4.95	AV	Horizontal
5150	61.24	5.36	35.66	44.22	58.04	74	-15.96	Pk	Vertical
5150	53.87	5.36	35.66	44.22	50.67	54	-3.33	AV	Vertical
5350	68.72	5.68	35.68	44.22	65.86	74	-8.14	Pk	Vertical
5350	51.52	5.68	35.68	44.22	48.66	54	-5.34	AV	Vertical
5350	64.13	5.68	35.68	44.22	61.27	74	-12.73	Pk	Horizontal
5350	46.31	5.68	35.68	44.22	43.45	54	-10.55	AV	Horizontal

Note: (1) Emission Level= Antenna Factor + Cable Loss + Read Level - Preamp Factor

(2) "802.11a " mode is the worst mode. When PK value is lower than the Average value limit, average don't record.

3. POWER SPECTRAL DENSITY TEST

3.1 APPLIED PROCEDURES / LIMIT

According to FCC §15.407(a)

For the band 5.15-5.25 GHz,

(i) For an outdoor access point operating in the band 5.15-5.25 GHz, the maximum power spectral density shall not exceed 17 dBm in any 1 megahertz band. If transmitting antennas of directional gain greater than 6 dBi are used, both the maximum conducted output power and the maximum power spectral density shall be reduced by the amount in dB that the directional gain of the antenna exceeds 6 dBi. The maximum e.i.r.p. at any elevation angle above 30 degrees as measured from the horizon must not exceed 125 mW (21 dBm).

(ii) For an indoor access point operating in the band 5.15-5.25 GHz, the maximum power spectral density shall not exceed 17 dBm in any 1 megahertz band. If transmitting antennas of directional gain greater than 6 dBi are used, both the maximum conducted output power and the maximum power spectral density shall be reduced by the amount in dB that the directional gain of the antenna exceeds 6 dBi.

(iii) For fixed point-to-point access points operating in the band 5.15-5.25 GHz, the maximum power spectral density shall not exceed 17 dBm in any 1 megahertz band. Fixed point-to-point U-NII devices may employ antennas with directional gain up to 23 dBi without any corresponding reduction in the maximum conducted output power or maximum power spectral density. For fixed point-to-point transmitters that employ a directional antenna gain greater than 23 dBi, a 1 dB reduction in maximum conducted output power and maximum power spectral density is required for each 1 dB of antenna gain in excess of 23 dBi. Fixed, point-to-point operations exclude the use of point-to-multipoint systems, omnidirectional applications, and multiple collocated transmitters transmitting the same information. The operator of the U-NII device, or if the equipment is professionally installed, the installer, is responsible for ensuring that systems employing high gain directional antennas are used exclusively for fixed, point-to-point operations.

(iv) For client devices in the 5.15-5.25 GHz band, the maximum power spectral density shall not exceed 11 dBm in any 1 megahertz band. If transmitting antennas of directional gain greater than 6 dBi are used, both the maximum conducted output power and the maximum power spectral density shall be reduced by the amount in dB that the directional gain of the antenna exceeds 6 dBi.

For the band 5.725-5.85 GHz

(3) For the band 5.725-5.85 GHz, the maximum power spectral density shall not exceed 30 dBm in any 500-kHz band. If transmitting antennas of directional gain greater than 6 dBi are used, both the maximum conducted output power and the maximum power spectral density shall be reduced by the amount in dB that the directional gain of the antenna exceeds 6 dBi.

3.2 TEST PROCEDURE

For devices operating in the bands 5.15-5.25 GHz, 5.25-5.35 GHz, and 5.47-5.725 GHz, the above procedures make use of 1 MHz RBW to satisfy directly the 1 MHz reference bandwidth specified in § 15.407(a)(5). For devices operating in the band 5.725-5.85 GHz, the rules specify a measurement bandwidth of 500 kHz. Many spectrum analyzers do not have 500 kHz RBW, thus a narrower RBW may need to be used. The rules permit the use of a RBWs less than 1 MHz, or 500 kHz, “provided that the measured power is integrated over the full reference bandwidth” to show the total power over the specified measurement bandwidth (i.e., 1 MHz, or 500 kHz). If measurements are performed using a reduced resolution bandwidth (< 1 MHz, or < 500 kHz) and integrated over 1 MHz, or 500 KHz bandwidth, the following adjustments to the procedures apply:

- a) Set $RBW \geq 1/T$, where T is defined in section II.B.I.a).
- b) Set $VBW \geq 3 RBW$.
- c) If measurement bandwidth of Maximum PSD is specified in 500 kHz, add $10\log(500\text{kHz}/RBW)$ to the measured result, whereas $RBW (< 500 \text{ KHz})$ is the reduced resolution bandwidth of the spectrum analyzer set during measurement.
- d) If measurement bandwidth of Maximum PSD is specified in 1 MHz, add $10\log(1\text{MHz}/RBW)$ to the measured result, whereas $RBW (< 1 \text{ MHz})$ is the reduced resolution bandwidth of spectrum analyzer set during measurement.
- e) Care must be taken to ensure that the measurements are performed during a period of continuous transmission or are corrected upward for duty cycle.

Note: As a practical matter, it is recommended to use reduced RBW of 100 KHz for the sections 5.c) and 5.d) above, since $RBW=100 \text{ KHz}$ is available on nearly all spectrum analyzers.

3.3 DEVIATION FROM STANDARD

No deviation.

3.4 TEST SETUP



3.5 EUT OPERATION CONDITIONS

The EUT tested system was configured as the statements of 2.1 Unless otherwise a special operating condition is specified in the follows during the testing.

3.6 TEST RESULTS

EUT :	PROJECTOR	Model Name :	Q6-2
Temperature :	26 °C	Relative Humidity :	54%
Pressure :	1015 hPa	Test Voltage :	AC 120V/60Hz
Test Mode :	TX Frequency Band 1 (5150-5250MHz)		

Test data reference attachment.

4. 26DB & 99% EMISSION BANDWIDTH

4.1 APPLIED PROCEDURES / LIMIT

The maximum power spectral density is measured as a conducted emission by direct connection of a calibrated test instrument to the equipment under test. If the device cannot be connected directly, alternative techniques acceptable to the Commission may be used. Measurements in the 5.725-5.85 GHz band are made over a reference bandwidth of 500 kHz or the 26 dB emission bandwidth of the device, whichever is less. Measurements in the 5.15-5.25 GHz, 5.25-5.35 GHz, and the 5.47-5.725 GHz bands are made over a bandwidth of 1 MHz or the 26 dB emission bandwidth of the device, whichever is less. A narrower resolution bandwidth can be used, provided that the measured power is integrated over the full reference bandwidth.

4.2 TEST PROCEDURE

- a) Set RBW = approximately 1% of the emission bandwidth.
- b) Set the VBW > RBW.
- c) Detector = Peak.
- d) Trace mode = max hold.
- e) Measure the maximum width of the emission that is 26 dB down from the maximum of the emission. Compare this with the RBW setting of the analyzer. Readjust RBW and repeat measurement as needed until the RBW/EBW ratio is approximately 1%.

The following procedure shall be used for measuring (99 %) power bandwidth:

- 1. Set center frequency to the nominal EUT channel center frequency.
- 2. Set span = 1.5 times to 5.0 times the OBW.
- 3. Set RBW = 1 % to 5 % of the OBW
- 4. Set VBW ≥ 3 · RBW
- 5. Video averaging is not permitted. Where practical, a sample detection and single sweep mode shall be used. Otherwise, peak detection and max hold mode (until the trace stabilizes) shall be used.
- 6. Use the 99 % power bandwidth function of the instrument (if available).
- 7. If the instrument does not have a 99 % power bandwidth function, the trace data points are recovered and directly summed in power units. The recovered amplitude data points, beginning at the lowest frequency, are placed in a running sum until 0.5 % of the total is reached; that frequency is recorded as the lower frequency. The process is repeated until 99.5 % of the total is reached; that frequency is recorded as the upper frequency. The 99% occupied bandwidth is the difference between these two frequencies.

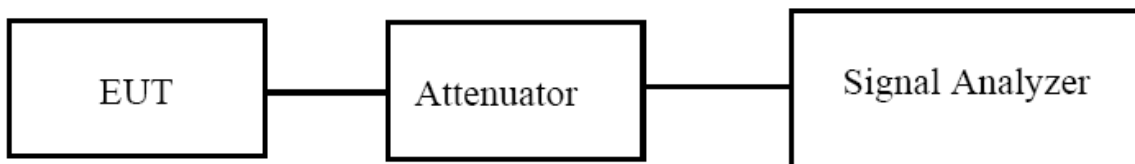

4.3 EUT OPERATION CONDITIONS

The EUT tested system was configured as the statements of 2.4 Unless otherwise a special operating condition is specified in the follows during the testing.

4.4 TEST RESULTS

EUT :	PROJECTOR	Model Name :	Q6-2
Temperature :	26 °C	Relative Humidity :	54%
Pressure :	1012 hPa	Test Voltage :	AC 120V/60Hz
Test Mode :	TX Frequency Band 1 (5150-5250MHz)		

Test data reference attachment.

5. MINIMUM 6 DB BANDWIDTH

5.1 APPLIED PROCEDURES / LIMIT

According to FCC §15.407(e)

(e) Within the 5.725-5.85 GHz band, the minimum 6 dB bandwidth of U-NII devices shall be at least 500 kHz.

5.2 TEST PROCEDURE

Section 15.407(e) specifies the minimum 6 dB emission bandwidth of at least 500 KHz for the band 5.715-5.85 GHz. The following procedure shall be used for measuring this bandwidth:

- a) Set RBW = 100 kHz.
- b) Set the video bandwidth (VBW) $\geq 3 \times$ RBW.
- c) Detector = Peak.
- d) Trace mode = max hold.
- e) Sweep = auto couple.
- f) Allow the trace to stabilize.
- g) Measure the maximum width of the emission that is constrained by the frequencies associated with the two outermost amplitude points (upper and lower frequencies) that are attenuated by 6 dB relative to the maximum level measured in the fundamental emission.

5.3 DEVIATION FROM STANDARD

No deviation.

5.4 TEST SETUP

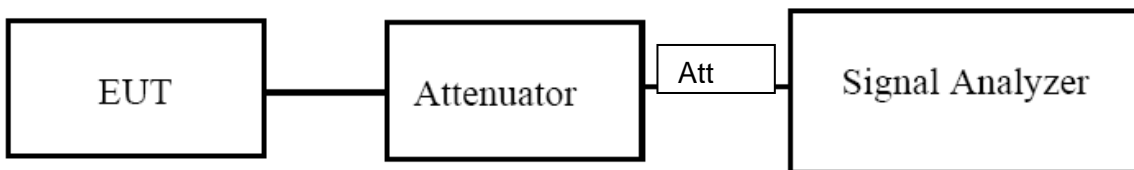

5.5 EUT OPERATION CONDITIONS

The EUT tested system was configured as the statements of 2.4 Unless otherwise a special operating condition is specified in the follows during the testing.

5.6 TEST RESULTS

EUT :	PROJECTOR	Model Name :	Q6-2
Temperature :	26 °C	Relative Humidity :	54%
Pressure :	1012 hPa	Test Voltage :	N/A
Test Mode :	N/A		

Note: Not applicable

6. MAXIMUM CONDUCTED OUTPUT POWER

6.1 APPLIED PROCEDURES / LIMIT

According to FCC §15.407

The maximum conducted output power should not exceed:

Frequency Band(MHz)	Limit
5150~5250	250mW
5250~5350	250 mW or 11 dBm + 10 log B Note: The limit is the smaller of the two, "B" represents -26dB bandwidth.
5470~5725	250 mW or 11 dBm + 10 log B Note: The limit is the smaller of the two, "B" represents -26dB bandwidth.
5725~5850	1W

6.2 TEST PROCEDURE

- Method PM is Measurement using an RF average power meter. The procedure for this method is as follows:
 - a) Measurements may be performed using a wideband RF power meter with a thermocouple detector or equivalent if all of the following conditions are satisfied:
 - 1) The EUT is configured to transmit continuously, or to transmit with a constant duty cycle.
 - 2) At all times when the EUT is transmitting, it shall be transmitting at its maximum power control level.
 - 3) The integration period of the power meter exceeds the repetition period of the transmitted signal by at least a factor of five.
 - b) If the transmitter does not transmit continuously, measure the duty cycle D of the transmitter output signal as described in 12.2.
 - c) Measure the average power of the transmitter. This measurement is an average over both the ON and OFF periods of the transmitter.
 - d) Adjust the measurement in dBm by adding $[10 \log (1 / D)]$, where D is the duty cycle {e.g., $[10 \log (1 / 0.25)]$, if the duty cycle is 25%}.

6.3 DEVIATION FROM STANDARD

No deviation.

6.4 TEST SETUP

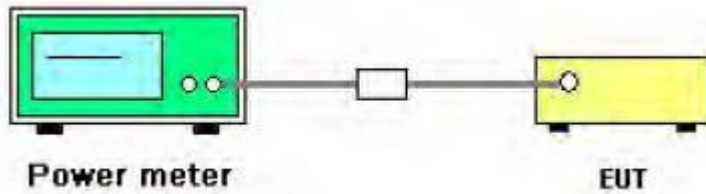

6.5 EUT OPERATION CONDITIONS

The EUT tested system was configured as the statements of 2.4 Unless otherwise a special operating condition is specified in the follows during the testing.

6.2 TEST RESULTS

EUT :	PROJECTOR	Model Name :	Q6-2
Temperature :	26 °C	Relative Humidity :	54%
Pressure :	1012 hPa	Test Voltage :	AC 120V/60Hz
Test Mode :	TX (5G) Mode Frequency Band 1 (5150-5250MHz)		

Test data reference attachment.

7. OUT OF BAND EMISSIONS

7.1 APPLICABLE STANDARD

According to FCC §15.407(b)

Undesirable emission limits. Except as shown in paragraph (b)(7) of this section, the maximum emissions outside of the frequency bands of operation shall be attenuated in accordance with the following limits:

- (1) For transmitters operating in the 5.15-5.25 GHz band: All emissions outside of the 5.15-5.35 GHz band shall not exceed an e.i.r.p. of -27 dBm/MHz.
- (2) For transmitters operating in the 5.25-5.35 GHz band: All emissions outside of the 5.15-5.35 GHz band shall not exceed an e.i.r.p. of -27 dBm/MHz.
- (3) For transmitters operating in the 5.47-5.725 GHz band: All emissions outside of the 5.47-5.725 GHz band shall not exceed an e.i.r.p. of -27 dBm/MHz.
- (4) For transmitters operating in the 5.725-5.85 GHz band:
 - (i) All emissions shall be limited to a level of -27 dBm/MHz at 75 MHz or more above or below the band edge increasing linearly to 10 dBm/MHz at 25 MHz above or below the band edge, and from 25 MHz above or below the band edge increasing linearly to a level of 15.6 dBm/MHz at 5 MHz above or below the band edge, and from 5 MHz above or below the band edge increasing linearly to a level of 27 dBm/MHz at the band edge.
 - (ii) Devices certified before March 2, 2017 with antenna gain greater than 10 dBi may demonstrate compliance with the emission limits in §15.247(d), but manufacturing, marketing and importing of devices certified under this alternative must cease by March 2, 2018. Devices certified before March 2, 2018 with antenna gain of 10 dBi or less may demonstrate compliance with the emission limits in §15.247(d), but manufacturing, marketing and importing of devices certified under this alternative must cease before March 2, 2020.

7.2 TEST PROCEDURE

1. Check the calibration of the measuring instrument using either an internal calibrator or a known signal from an external generator.
2. Position the EUT without connection to measurement instrument. Turn on the EUT and connect its antenna terminal to measurement instrument via a low loss cable. Then set it to any one measured frequency within its operating range, and make sure the instrument is operated in its linear range.
3. Set RBW of spectrum analyzer to 1 MHz with a convenient frequency span.
4. Measure the highest amplitude appearing on spectral display and set it as a reference level. Plot

the graph with marking the highest point and edge frequency.

5. Repeat above procedures until all measured frequencies were complete.

7.3 DEVIATION FROM STANDARD

No deviation.

7.4 TEST SETUP

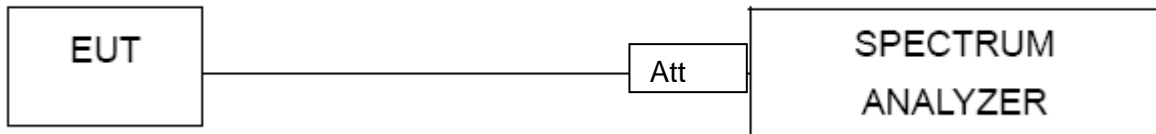

7.5 EUT OPERATION CONDITIONS

The EUT tested system was configured as the statements of 2.4 Unless otherwise a special operating condition is specified in the follows during the testing.

7.6 TEST RESULTS

EUT :	PROJECTOR	Model Name :	Q6-2
Temperature :	26 °C	Relative Humidity :	54%
Pressure :	1012 hPa	Test Voltage :	AC 120V/60Hz

Test data reference attachment.

8. Frequency Stability Measurement

8.1 LIMIT

Manufactures of U-NII devices are responsible for ensuring frequency stability such that an emission is maintained within the band of operation under all conditions of normal operation as specified in the user's manual.

8.2 TEST PROCEDURES

1. The transmitter output (antenna port) was connected to the spectrum analyzer.
2. EUT have transmitted absence of modulation signal and fixed channelize.
3. Set the spectrum analyzer span to view the entire absence of modulation emissions bandwidth.
4. Set RBW = 10 kHz, VBW = 10 kHz with peak detector and maxhold settings.
5. f_c is declaring of channel frequency. Then the frequency error formula is $(f_c - f) / f_c \times 10^6$ ppm and the limit is less than ± 20 ppm (IEEE 802.11 specification).
6. The test extreme voltage is to change the primary supply voltage from 85 to 115 percent of the nominal value
7. Extreme temperature is $-20^\circ\text{C} \sim 70^\circ\text{C}$.

8.3 TEST SETUP LAYOUT

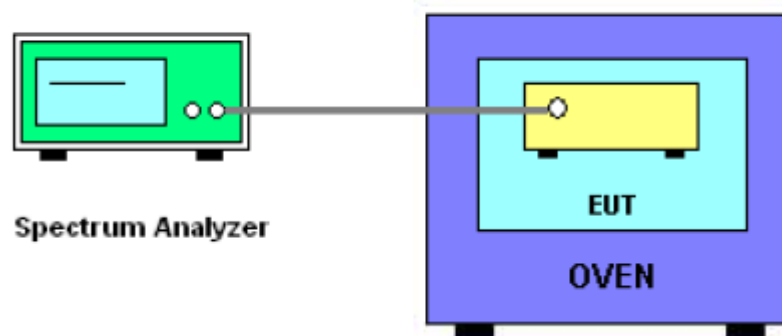

8.4 EUT OPERATION DURING TEST

1. The EUT was programmed to be in continuously un-modulation transmitting mode.
2. The module has two antennas, and the worst data is Antenna 1, only shown Antenna 1 data.

8.5 TEST RESULTS

EUT :	PROJECTOR	Model Name. :	Q6-2
Temperature :	25 °C	Relative Humidity :	56%
Pressure :	1012 hPa	Test Voltage :	AC 120V/60Hz
Test Mode :	TX Frequency Band I (5150-5250MHz)		

Voltage vs. Frequency Stability

TEST CONDITIONS				Reference Frequency: 5180MHz			
				f	fc	Max. Deviation (MHz)	Max. Deviation (ppm)
T nom (°C)	20	V nom (V)	120	5180.0157	5180	0.0157	-3.0309
		V max (V)	132	5180.0185	5180	0.0185	-3.5714
		V min (V)	108	5180.0401	5180	0.0401	-7.7413
Limits				Within 5150-5250MHz			
Result				Complies			

Temperature vs. Frequency Stability

TEST CONDITIONS				Reference Frequency: 5180MHz			
				f	fc	Max. Deviation (MHz)	Max. Deviation (ppm)
V nom (V)	12	T (°C)	-20	5180.0292	5180	0.0292	-5.6371
		T (°C)	-10	5180.0100	5180	0.0100	-1.9305
		T (°C)	0	5180.0571	5180	0.0571	-11.0232
		T (°C)	10	5180.0338	5180	0.0338	-6.5251
		T (°C)	20	5180.0092	5180	0.0092	-1.7761
		T (°C)	30	5180.0576	5180	0.0576	-11.1197
		T (°C)	40	5180.0131	5180	0.0131	-2.5290
		T (°C)	50	5180.0606	5180	0.0606	-11.6988
		T (°C)	60	5180.0289	5180	0.0289	-5.5792
		T (°C)	70	5180.0276	5180	0.0276	-5.3282
Limits				Within 5150-5250MHz			
Result				Complies			

Voltage vs. Frequency Stability

TEST CONDITIONS				Reference Frequency: 5200MHz			
				f	fc	Max. Deviation (MHz)	Max. Deviation (ppm)
T nom (°C)	20	V nom (V)	120	5200.0475	5200	0.0475	-9.1346
		V max (V)	132	5200.0655	5200	0.0655	-12.5962
		V min (V)	108	5200.0113	5200	0.0113	-2.1731
Limits				Within 5150-5250MHz			
Result				Complies			

Temperature vs. Frequency Stability

TEST CONDITIONS				Reference Frequency: 5200MHz			
				f	fc	Max. Deviation (MHz)	Max. Deviation (ppm)
V nom (V)	12	T (°C)	-20	5200.0107	5200	0.0107	-2.0577
		T (°C)	-10	5200.0230	5200	0.0230	-4.4231
		T (°C)	0	5200.0384	5200	0.0384	-7.3846
		T (°C)	10	5200.0312	5200	0.0312	-6.0000
		T (°C)	20	5200.0664	5200	0.0664	-12.7692
		T (°C)	30	5200.0363	5200	0.0363	-6.9808
		T (°C)	40	5200.0402	5200	0.0402	-7.7308
		T (°C)	50	5200.0193	5200	0.0193	-3.7115
		T (°C)	60	5200.0687	5200	0.0687	-13.2115
		T (°C)	70	5200.0312	5200	0.0312	-6.0000
Limits				Within 5150-5250MHz			
Result				Complies			

Voltage vs. Frequency Stability

TEST CONDITIONS				Reference Frequency: 5240MHz			
				f	fc	Max. Deviation (MHz)	Max. Deviation (ppm)
T nom (°C)	20	V nom (V)	120	5240.0374	5240	0.0374	-7.1374
		V max (V)	132	5240.0620	5240	0.0620	-11.8321
		V min (V)	108	5240.0524	5240	0.0524	-10.0000
Limits				Within 5150-5250MHz			
Result				Complies			

Temperature vs. Frequency Stability

TEST CONDITIONS				Reference Frequency: 5240MHz			
				f	fc	Max. Deviation (MHz)	Max. Deviation (ppm)
V nom (V)	12	T (°C)	-20	5240.0725	5240	0.0725	-13.8359
		T (°C)	-10	5240.0636	5240	0.0636	-12.1374
		T (°C)	0	5240.0477	5240	0.0477	-9.1031
		T (°C)	10	5240.0190	5240	0.0190	-3.6260
		T (°C)	20	5240.0195	5240	0.0195	-3.7214
		T (°C)	30	5240.0228	5240	0.0228	-4.3511
		T (°C)	40	5240.0091	5240	0.0091	-1.7366
		T (°C)	50	5240.0478	5240	0.0478	-9.1221
		T (°C)	60	5240.0444	5240	0.0444	-8.4733
		T (°C)	70	5240.0417	5240	0.0417	-7.9580
Limits				Within 5150-5250MHz			
Result				Complies			

9. ANTENNA REQUIREMENT

9.1 STANDARD REQUIREMENT

15.203 requirement: For intentional device, according to 15.203: an intentional radiator shall be designed to ensure that no antenna other than that furnished by the responsible party shall be used with the device.

9.2 EUT ANTENNA

The EUT antenna is permanent attached FPCB Antenna (antenna gain: 2dBi). It comply with the standard requirement.

10. TEST RESULTS

10.1 DUTY CYCLE

Condition	Mode	Frequency (MHz)	Duty Cycle (%)	Correction Factor (dB)
NVNT	802.11a	5180	95.56	0.2
NVNT	802.11a	5200	95.56	0.2
NVNT	802.11a	5240	95.58	0.2
NVNT	802.11n(HT20)	5180	98.77	0.05
NVNT	802.11n(HT20)	5200	98.71	0.06
NVNT	802.11n(HT20)	5240	98.78	0.05
NVNT	802.11n(HT40)	5190	97.48	0.11
NVNT	802.11n(HT40)	5230	97.42	0.11

Duty Cycle NVNT 802.11a 5180MHz

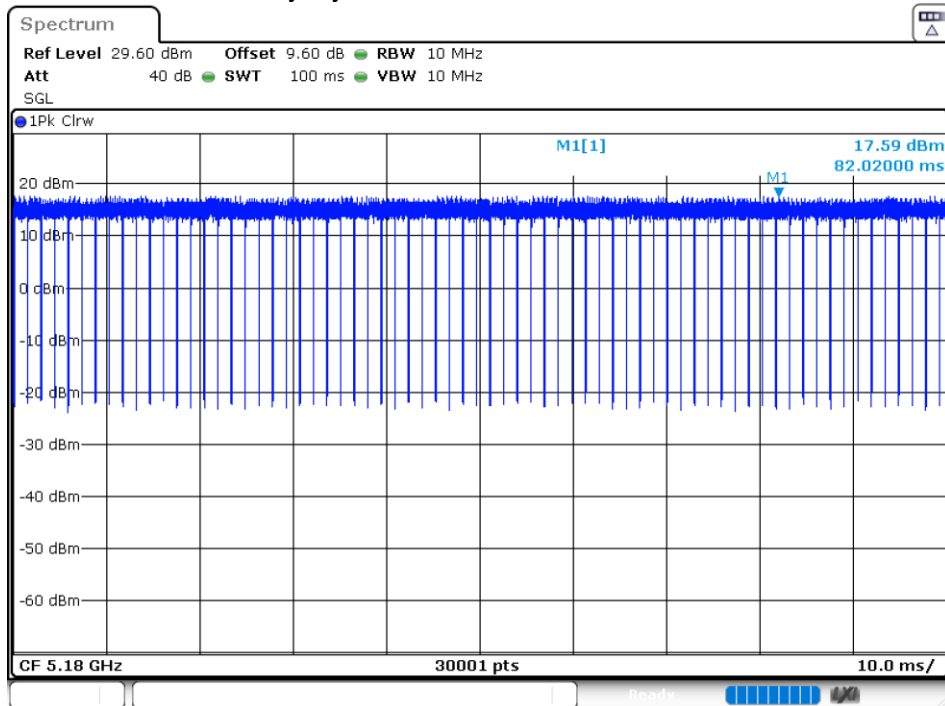

Duty Cycle NVNT 802.11a 5200MHz

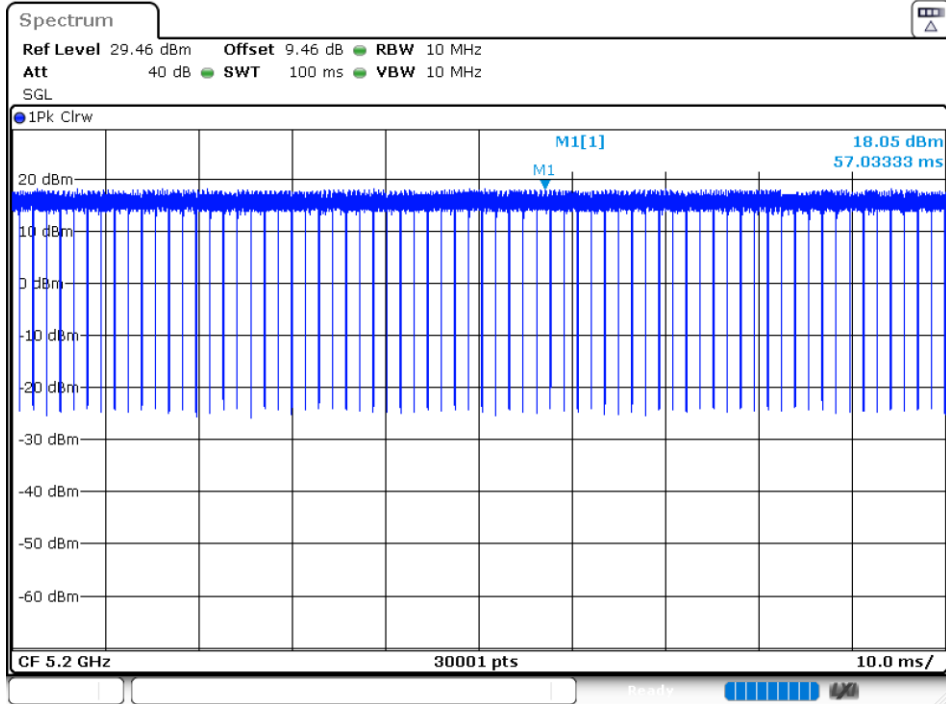

Duty Cycle NVNT 802.11a 5240MHz

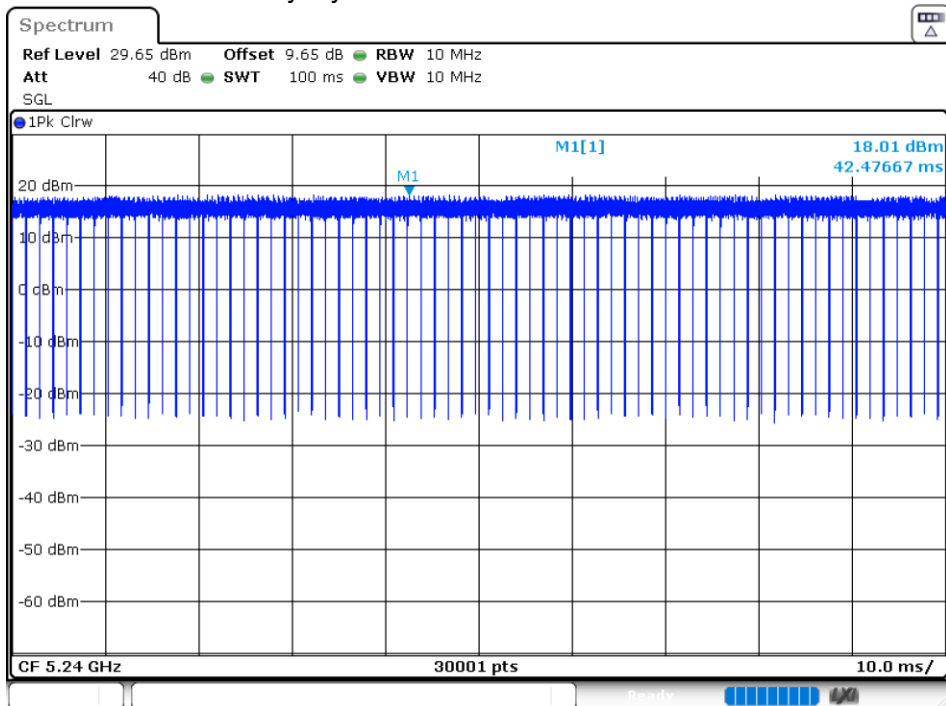

Duty Cycle NVNT 802.11n(HT20) 5180MHz

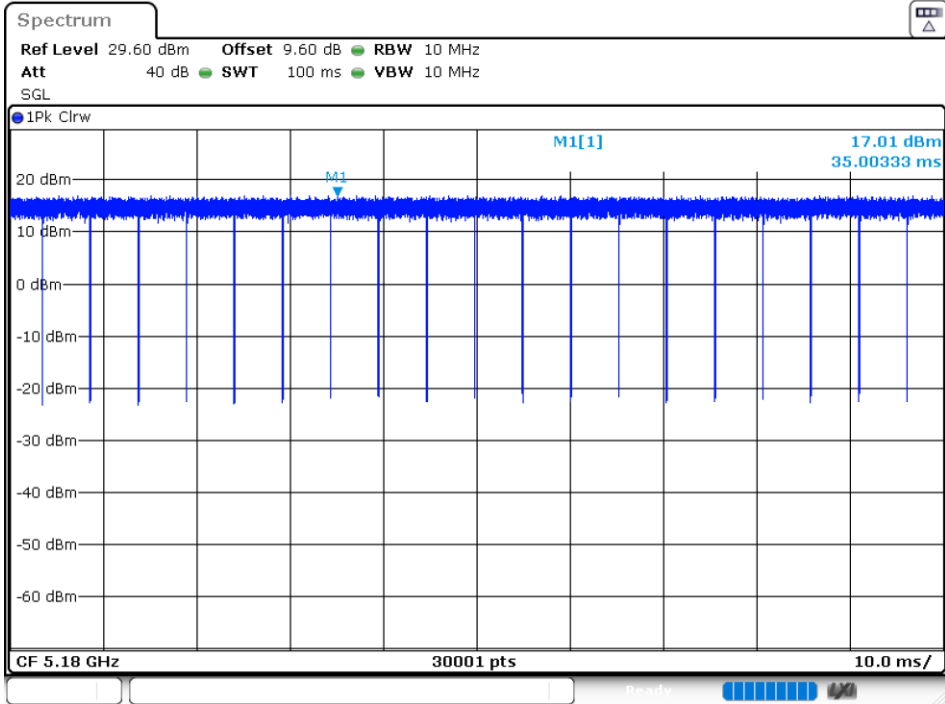

Duty Cycle NVNT 802.11n(HT20) 5200MHz

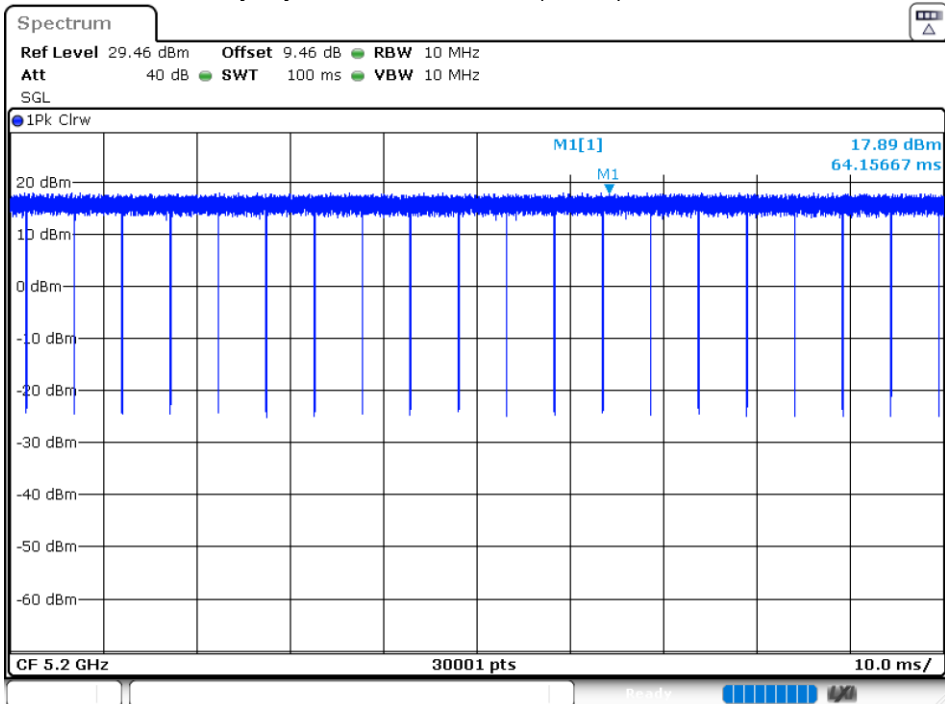

Duty Cycle NVNT 802.11n(HT20) 5240MHz

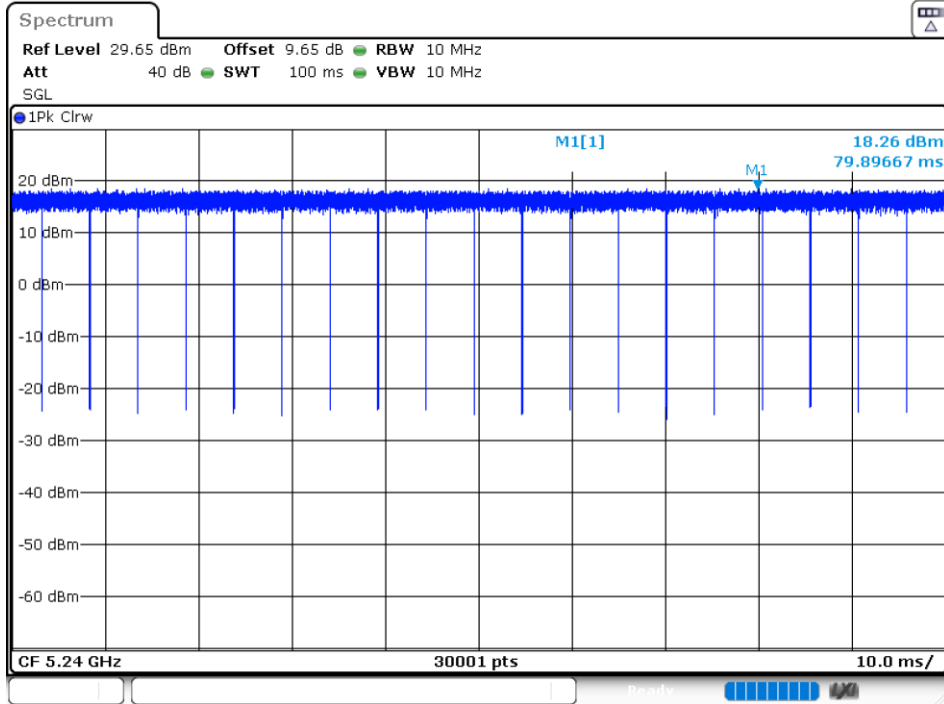

Duty Cycle NVNT 802.11n(HT40) 5190MHz

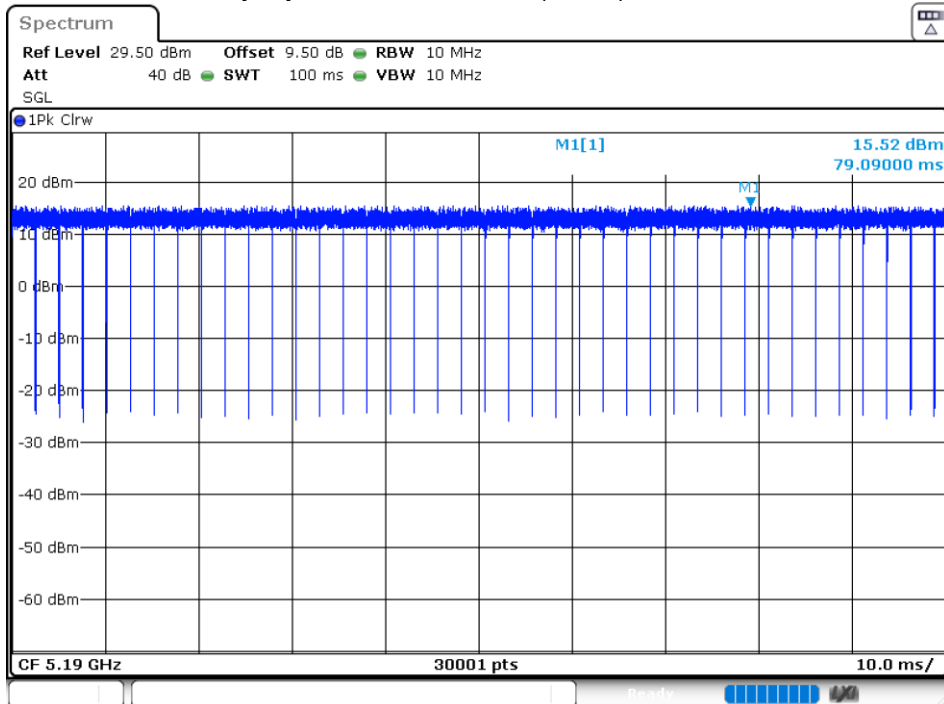

Duty Cycle NVNT 802.11n(HT40) 5230MHz

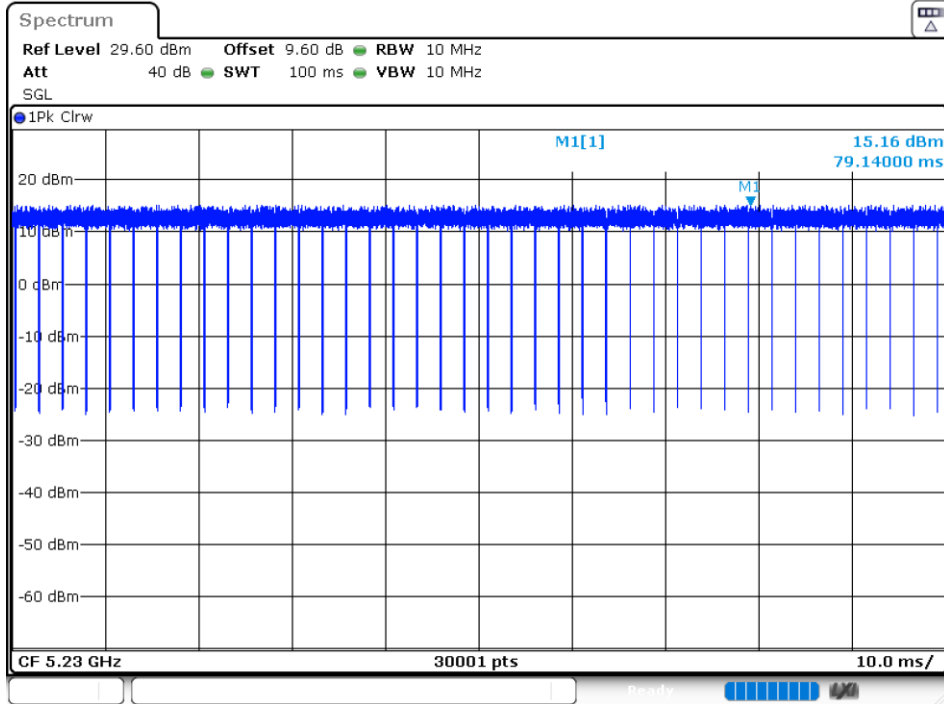

10.2 MAXIMUM CONDUCTED OUTPUT POWER

Condition	Mode	Frequency (MHz)	Antenna	Conducted Power (dBm)	Duty Factor (dB)	Total Power (dBm)	Limit (dBm)	Verdict
NVNT	802.11a	5180	Ant 1	10.05	0.2	10.25	24	Pass
NVNT	802.11a	5200	Ant 1	10.45	0.2	10.65	24	Pass
NVNT	802.11a	5240	Ant 1	10.11	0.2	10.31	24	Pass
NVNT	802.11n(HT20)	5180	Ant 1	10.01	0.05	10.06	24	Pass
NVNT	802.11n(HT20)	5200	Ant 1	10.81	0.06	10.87	24	Pass
NVNT	802.11n(HT20)	5240	Ant 1	10.92	0.05	10.97	24	Pass
NVNT	802.11n(HT40)	5190	Ant 1	10.43	0.11	10.54	24	Pass
NVNT	802.11n(HT40)	5230	Ant 1	10.34	0.11	10.45	24	Pass

10.3 OCCUPIED CHANNEL BANDWIDTH

Condition	Mode	Frequency (MHz)	Antenna	99% OBW (MHz)	-26 dB Bandwidth (MHz)	Verdict
NVNT	802.11a	5180	Ant 1	16.8863	20.376	Pass
NVNT	802.11a	5200	Ant 1	16.9983	22.84	Pass
NVNT	802.11a	5240	Ant 1	16.8343	26.532	Pass
NVNT	802.11n(HT20)	5180	Ant 1	17.9302	24.508	Pass
NVNT	802.11n(HT20)	5200	Ant 1	17.8862	21.96	Pass
NVNT	802.11n(HT20)	5240	Ant 1	17.9182	28.552	Pass
NVNT	802.11n(HT40)	5190	Ant 1	36.7643	70.568	Pass
NVNT	802.11n(HT40)	5230	Ant 1	36.9323	73	Pass

OBW NVNT 802.11a 5180MHz Ant1

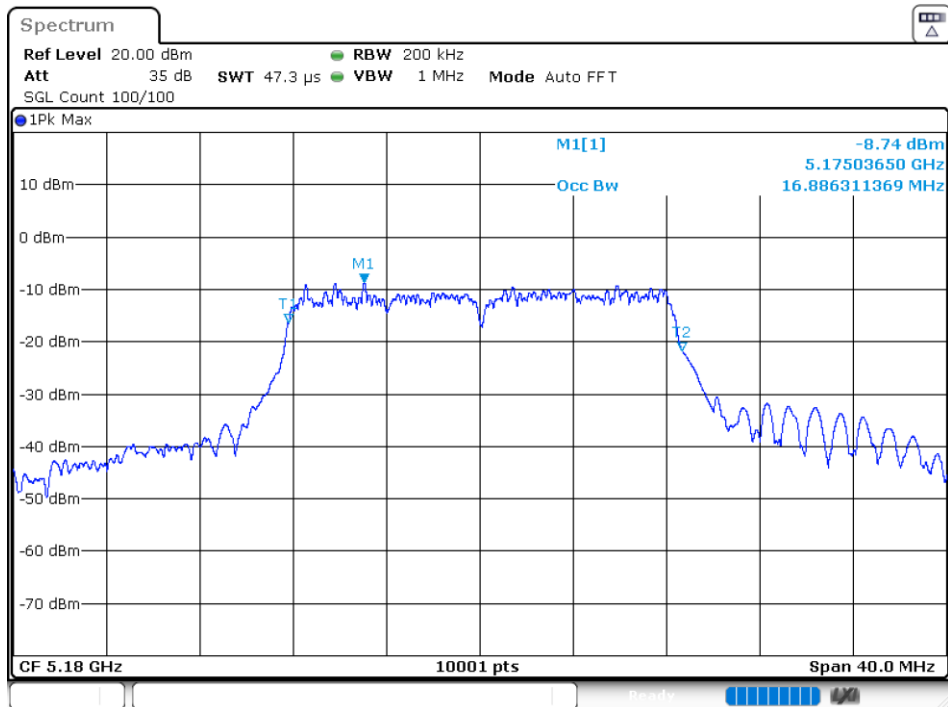

-26 dB BW NVNT 802.11a 5180MHz Ant1

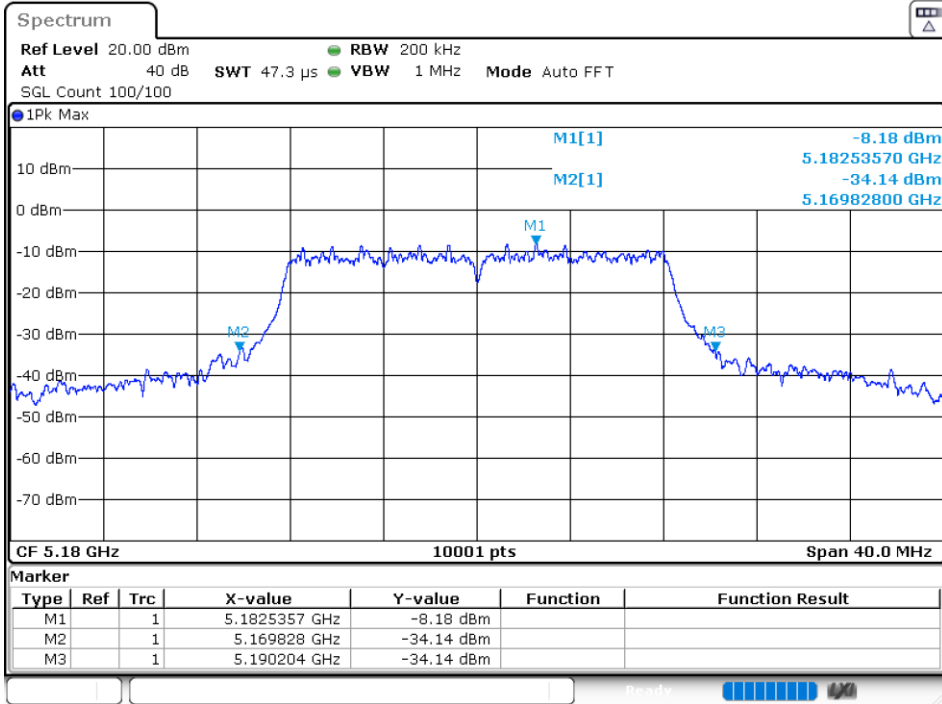

OBW NVNT 802.11a 5200MHz Ant1

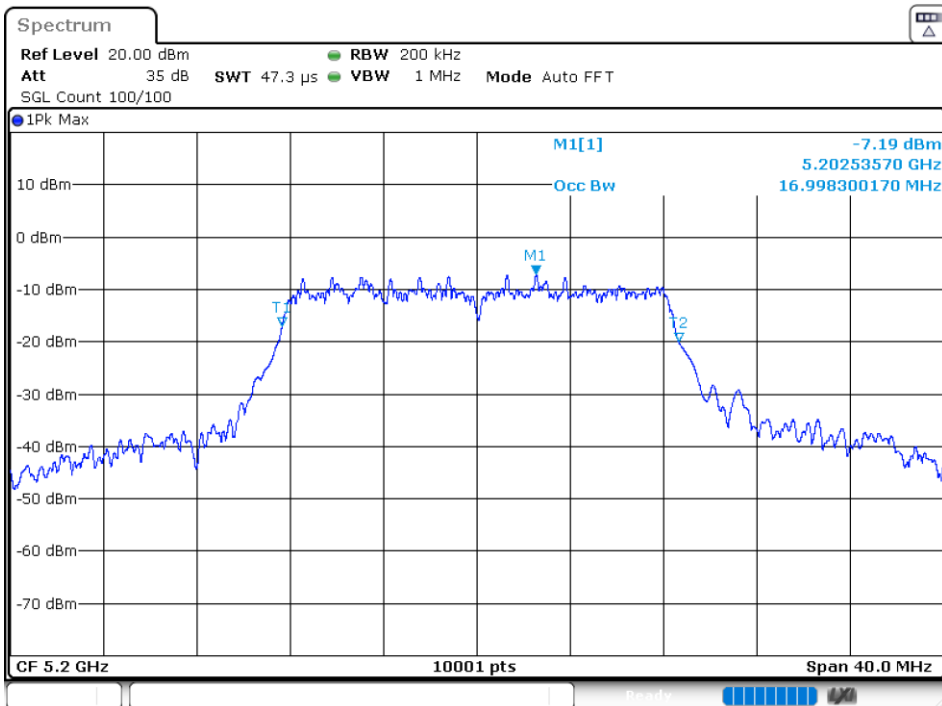

-26 dB BW NVNT 802.11a 5200MHz Ant1

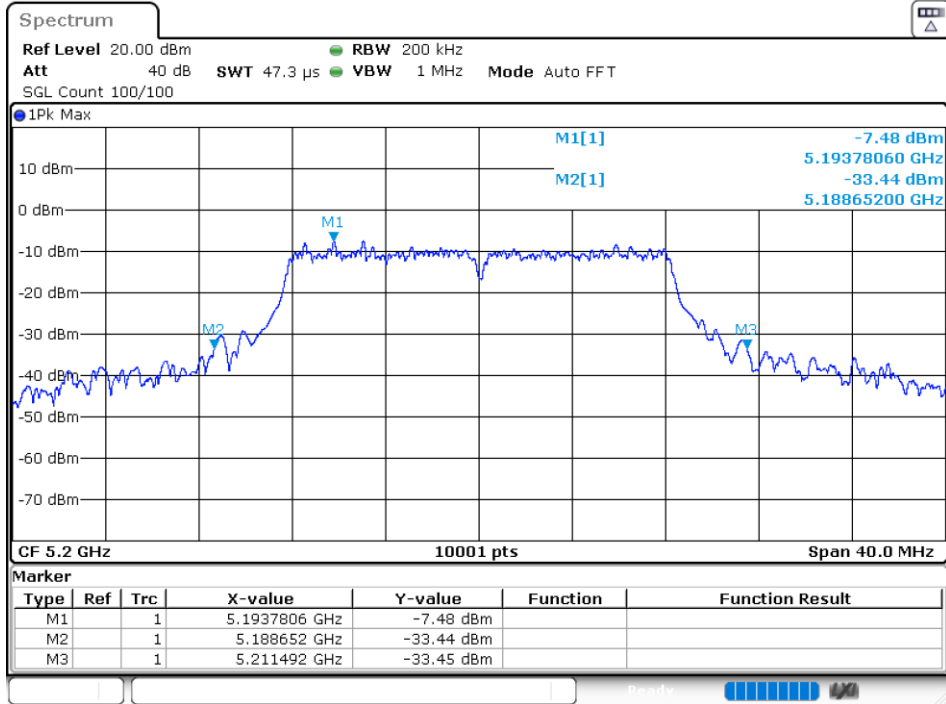

OBW NVNT 802.11a 5240MHz Ant1

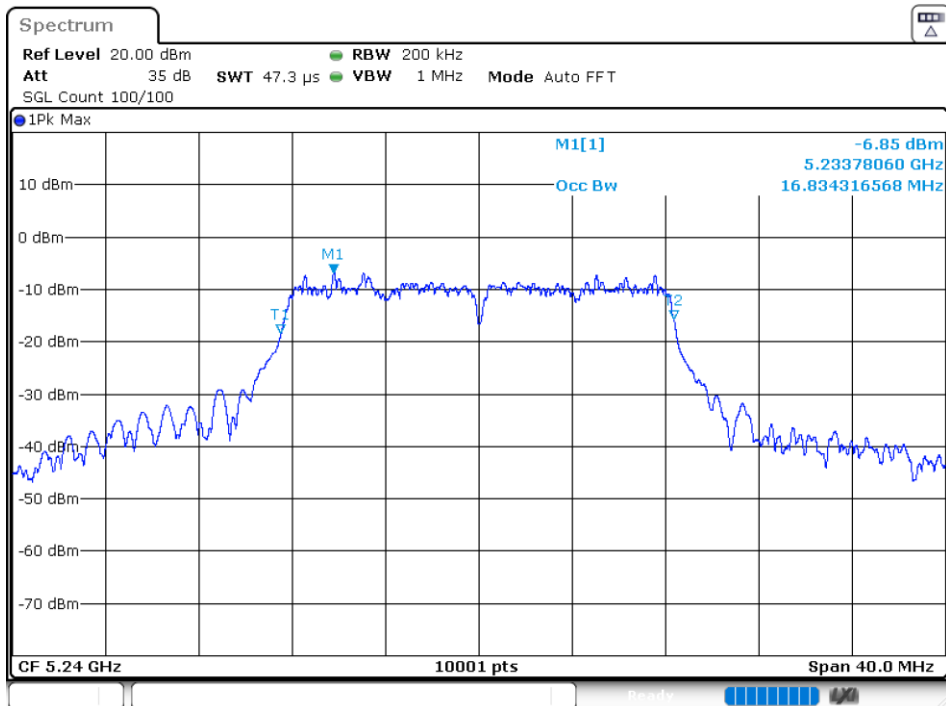

-26 dB BW NVNT 802.11a 5240MHz Ant1

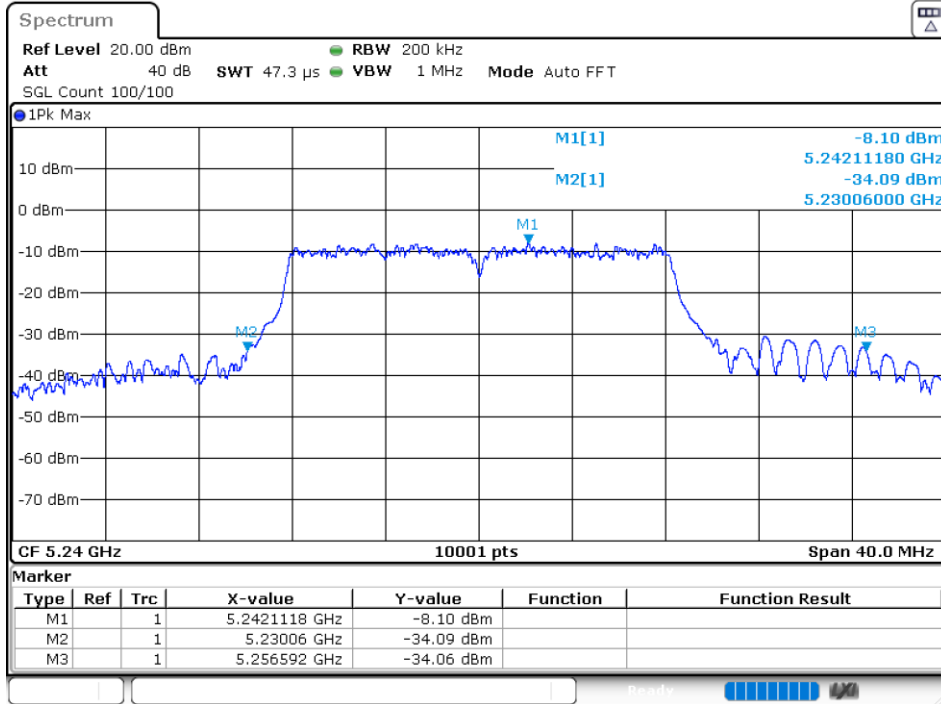

OBW NVNT 802.11n(HT20) 5180MHz Ant1

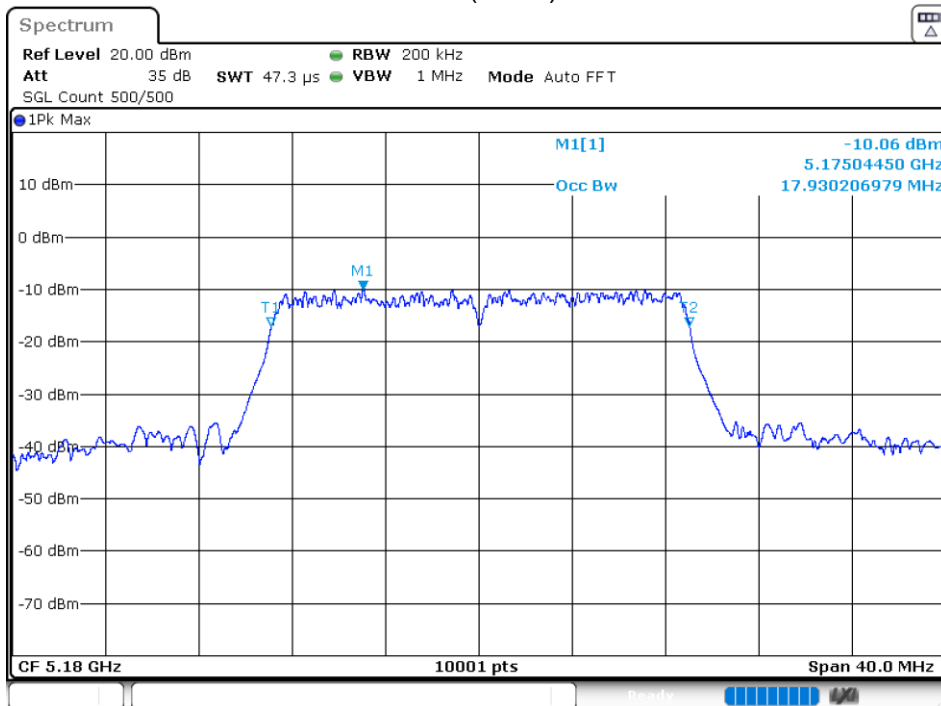

-26 dB BW NVNT 802.11n(HT20) 5180MHz Ant1

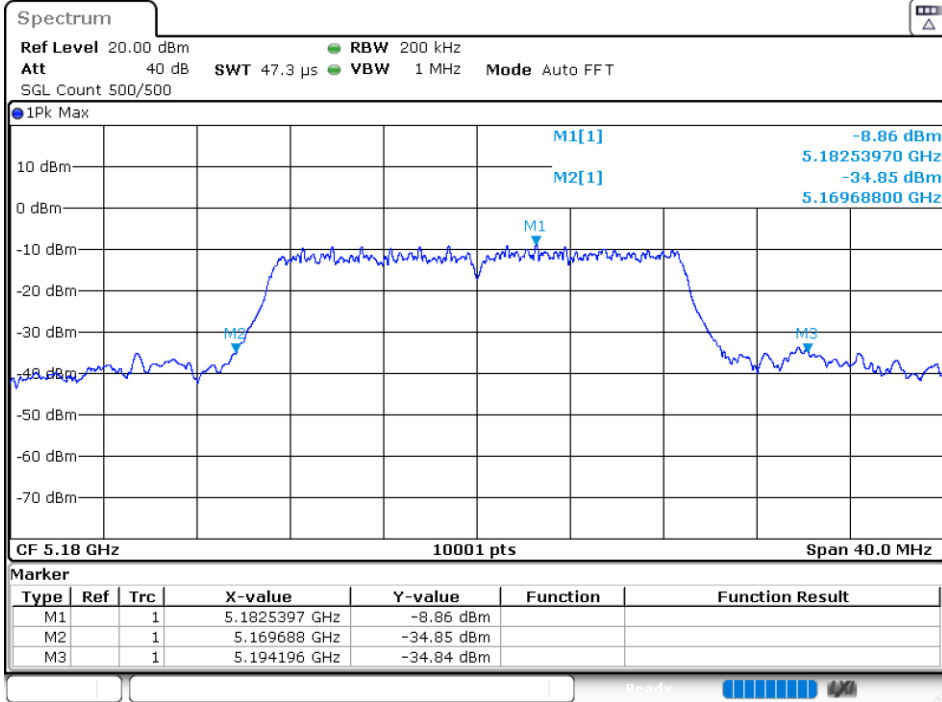

OBW NVNT 802.11n(HT20) 5200MHz Ant1

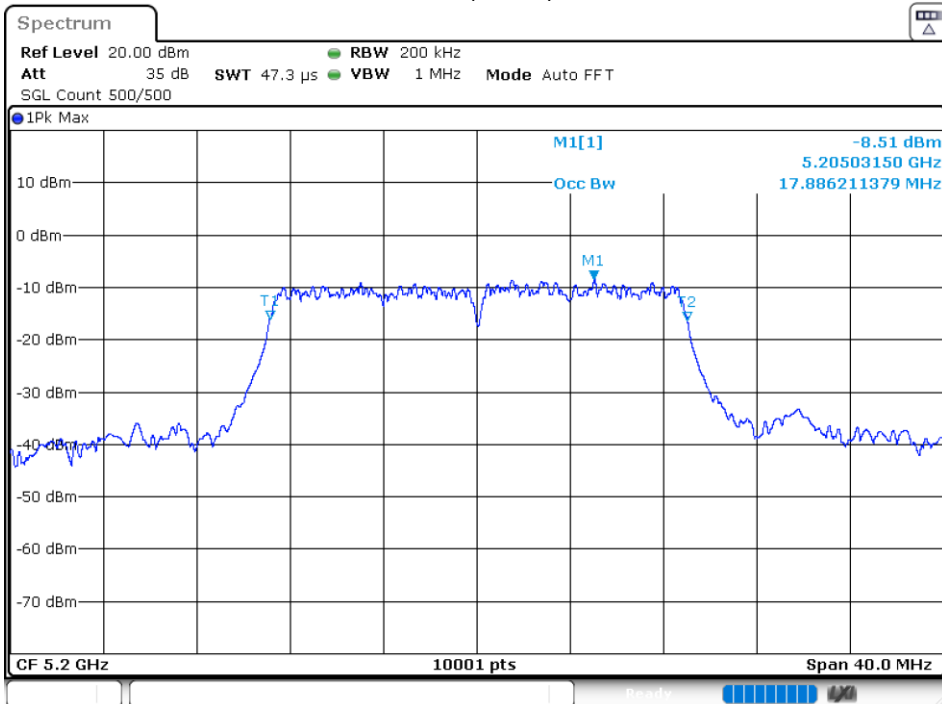

-26 dB BW NVNT 802.11n(HT20) 5200MHz Ant1

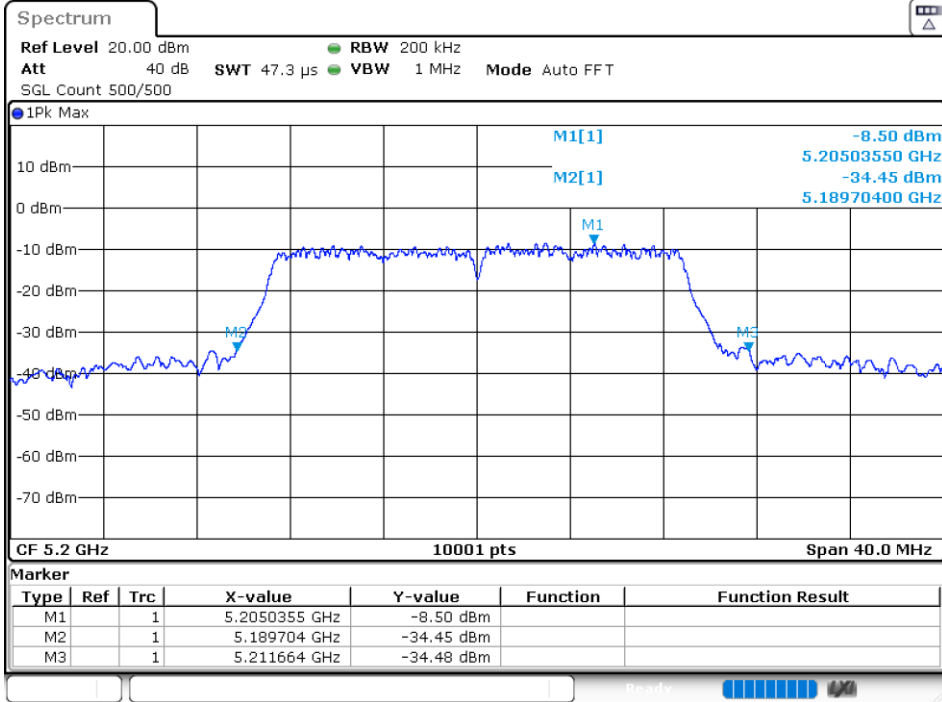

OBW NVNT 802.11n(HT20) 5240MHz Ant1

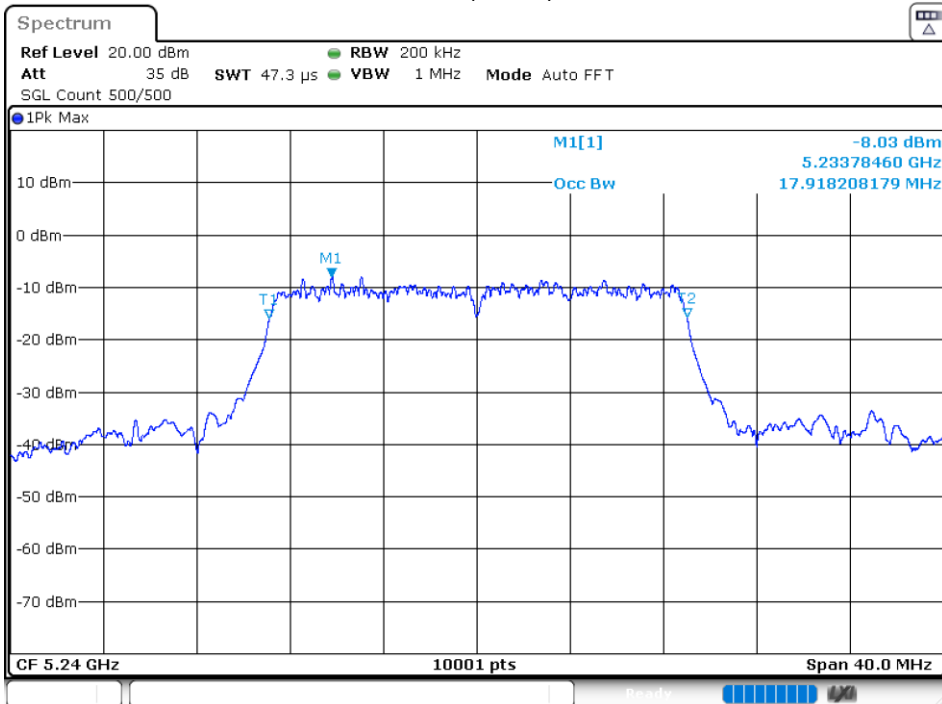

-26 dB BW NVNT 802.11n(HT20) 5240MHz Ant1

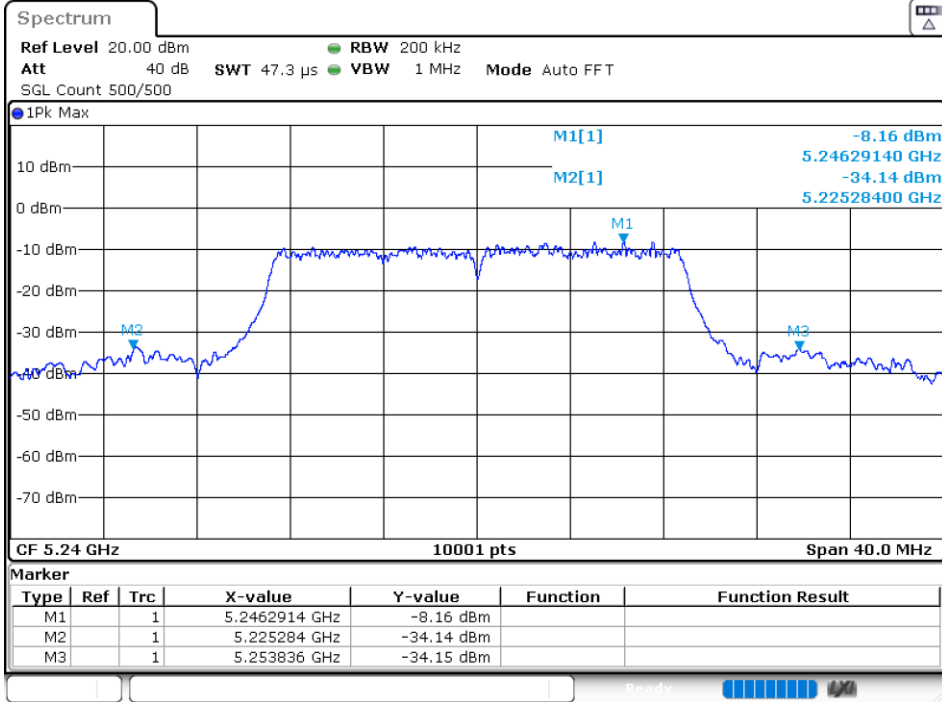

OBW NVNT 802.11n(HT40) 5190MHz Ant1

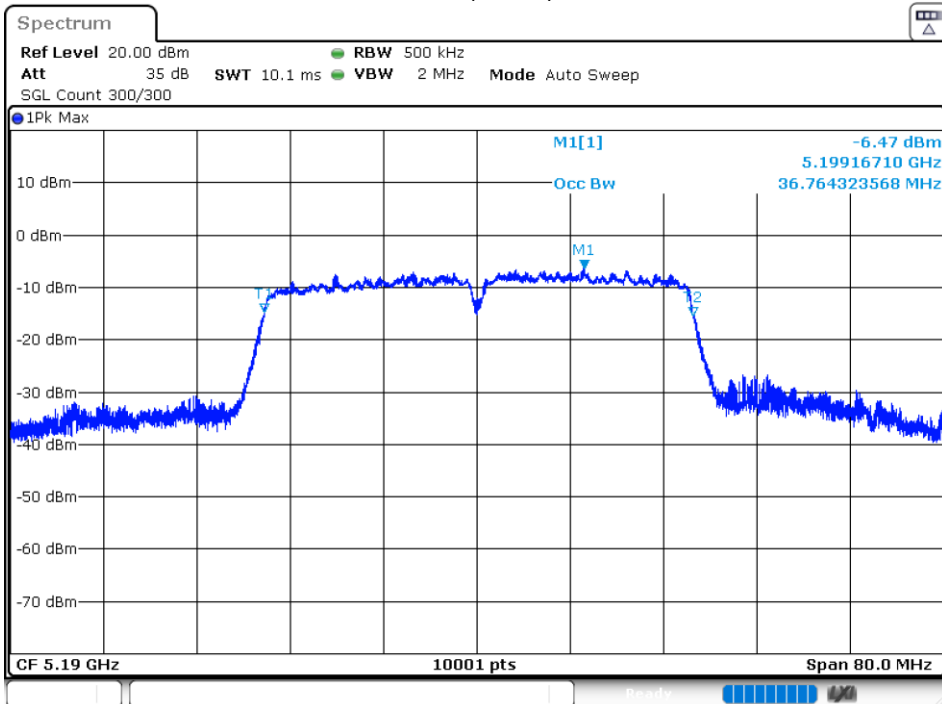

-26 dB BW NVNT 802.11n(HT40) 5190MHz Ant1

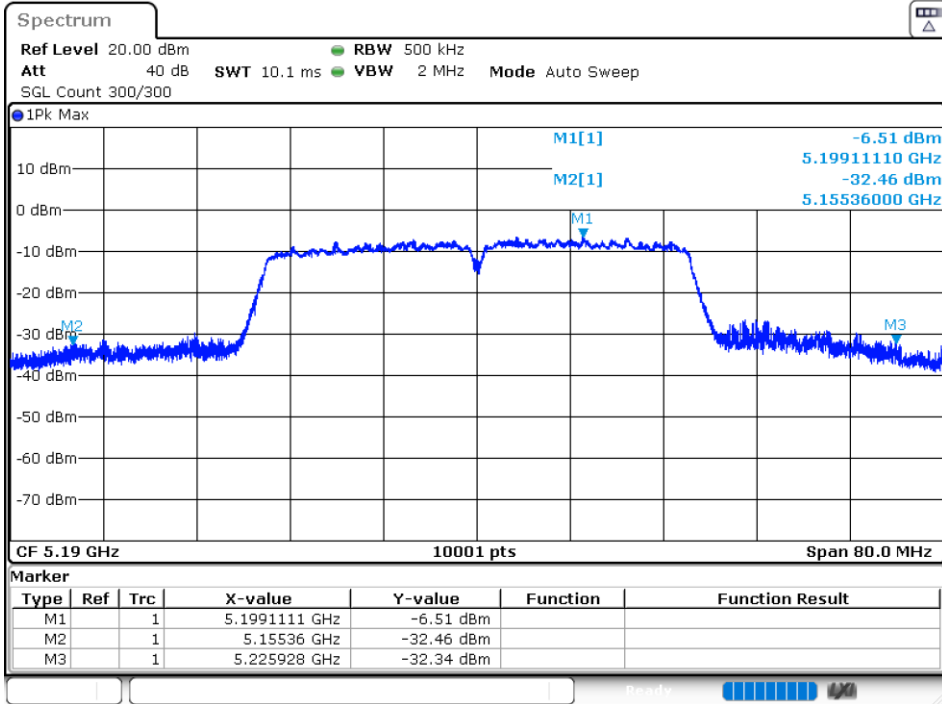

OBW NVNT 802.11n(HT40) 5230MHz Ant1

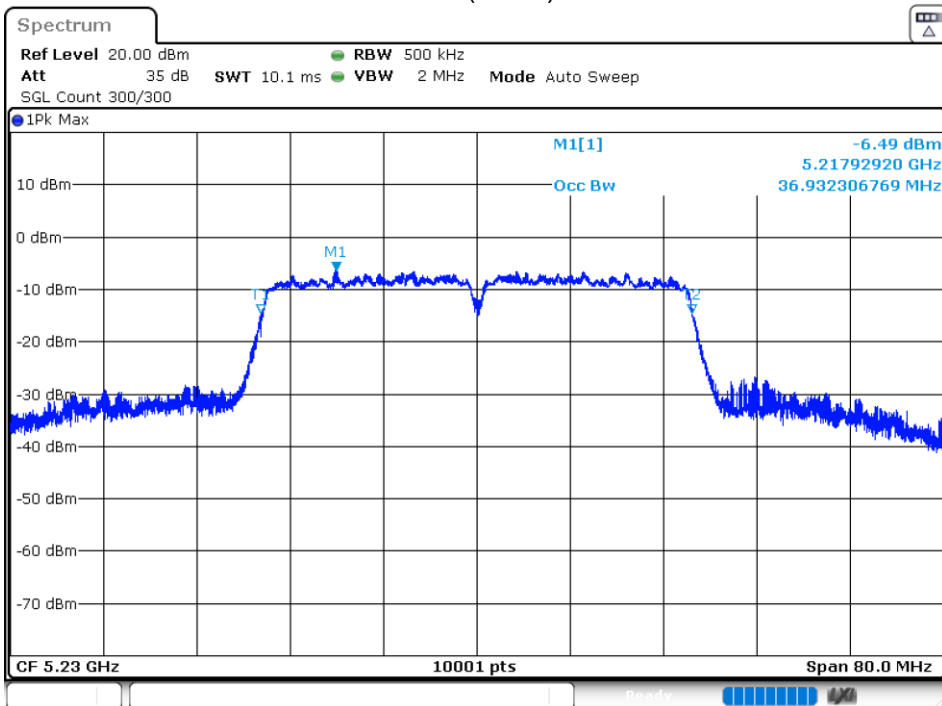

-26 dB BW NVNT 802.11n(HT40) 5230MHz Ant1

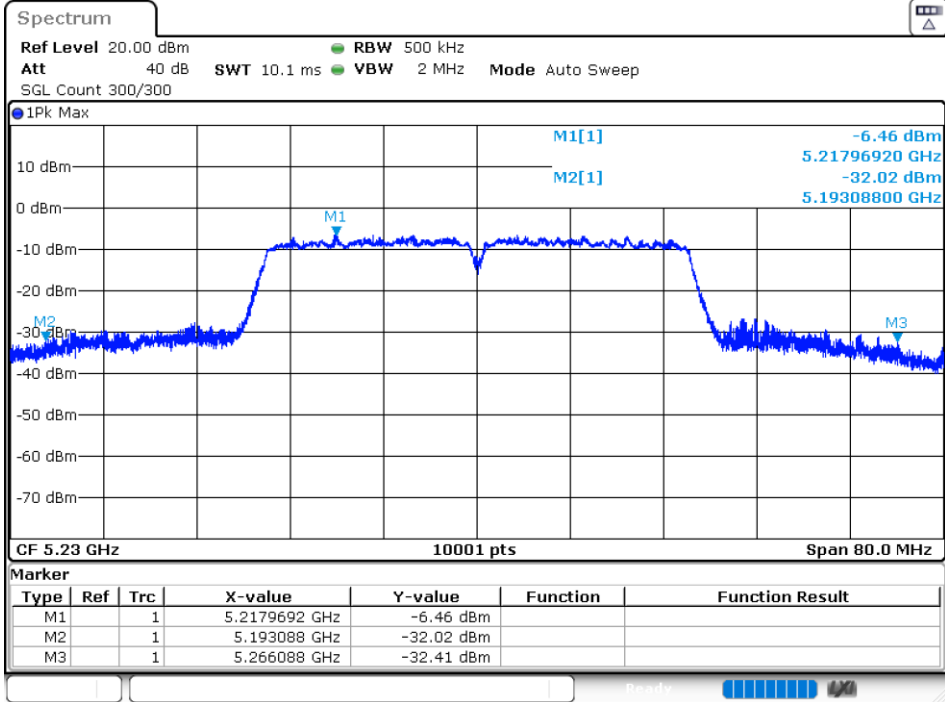

10.4 MAXIMUM POWER SPECTRAL DENSITY LEVEL

Condition	Mode	Frequency (MHz)	Antenna	Max PSD (dBm)	Limit (dBm)	Verdict
NVNT	802.11a	5180	Ant 1	-0.033	11	Pass
NVNT	802.11a	5200	Ant 1	0.264	11	Pass
NVNT	802.11a	5240	Ant 1	1.405	11	Pass
NVNT	802.11n(HT20)	5180	Ant 1	-0.766	11	Pass
NVNT	802.11n(HT20)	5200	Ant 1	-0.14	11	Pass
NVNT	802.11n(HT20)	5240	Ant 1	-0.699	11	Pass
NVNT	802.11n(HT40)	5190	Ant 1	-2.873	11	Pass
NVNT	802.11n(HT40)	5230	Ant 1	-2.915	11	Pass

PSD NVNT 802.11a 5180MHz Ant1

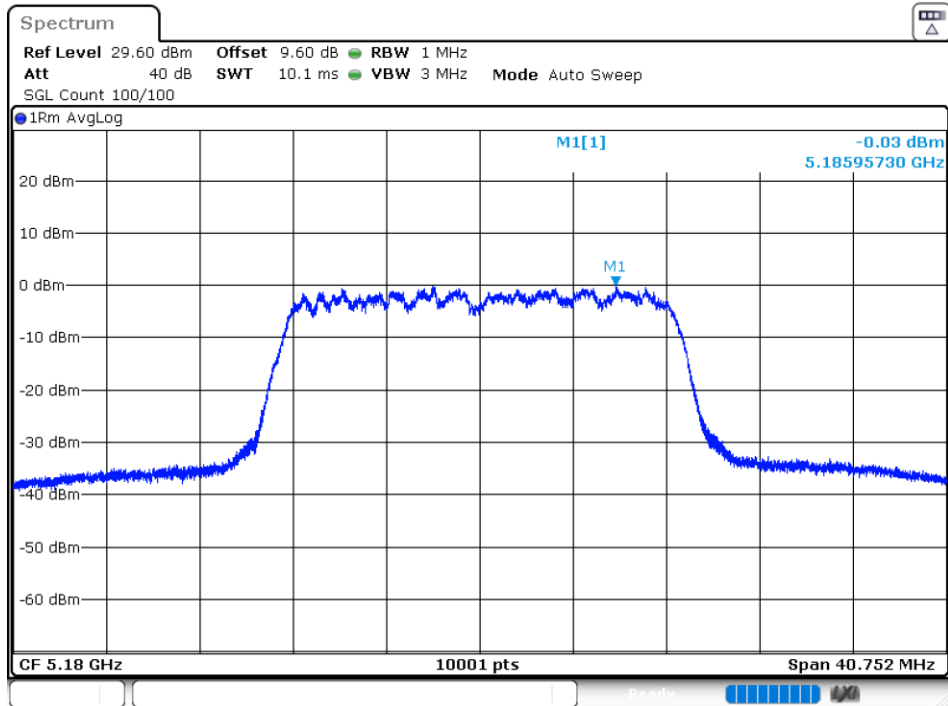

PSD NVNT 802.11a 5200MHz Ant1

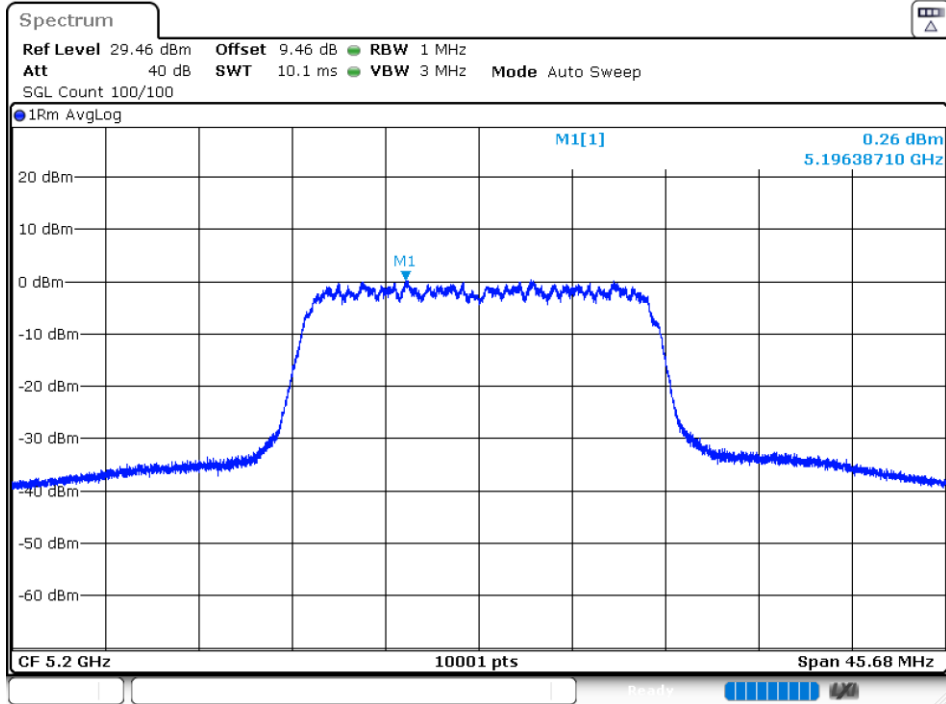

PSD NVNT 802.11a 5240MHz Ant1

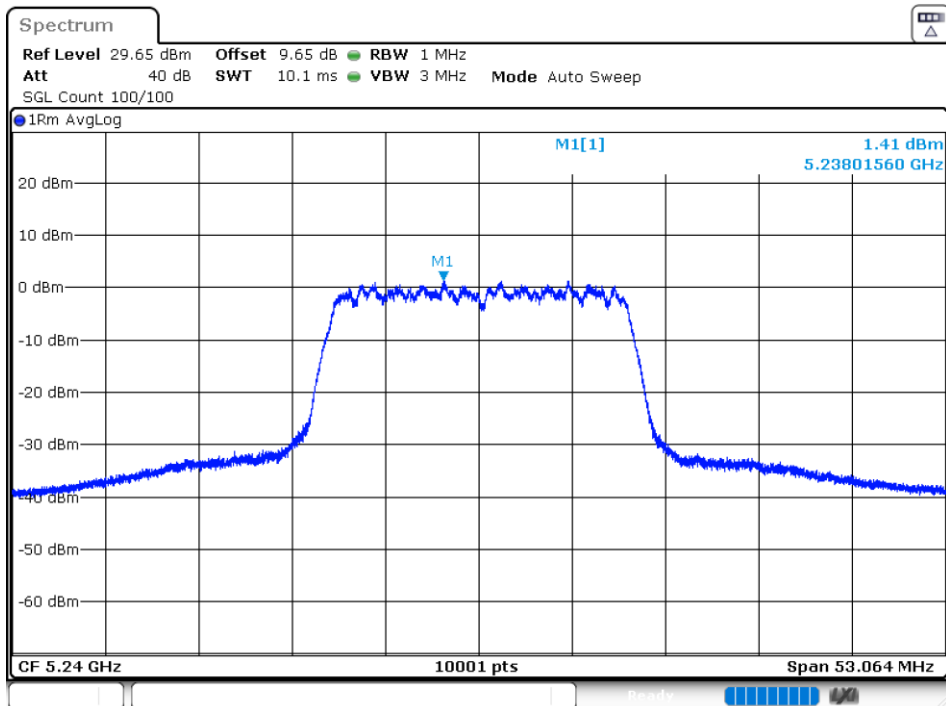

PSD NVNT 802.11n(HT20) 5180MHz Ant1

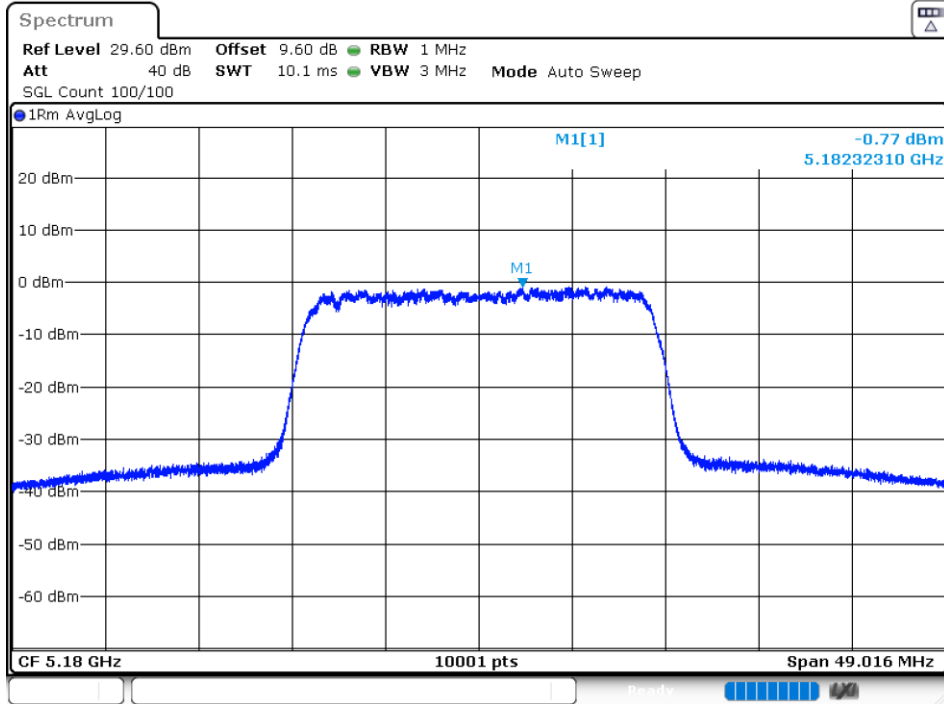

PSD NVNT 802.11n(HT20) 5200MHz Ant1

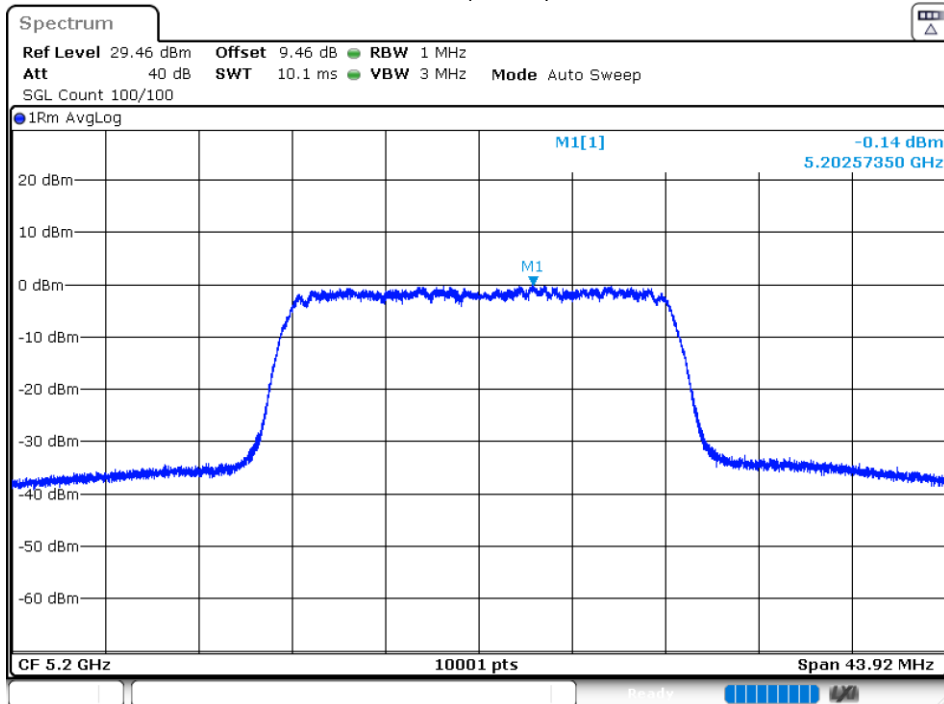

PSD NVNT 802.11n(HT20) 5240MHz Ant1

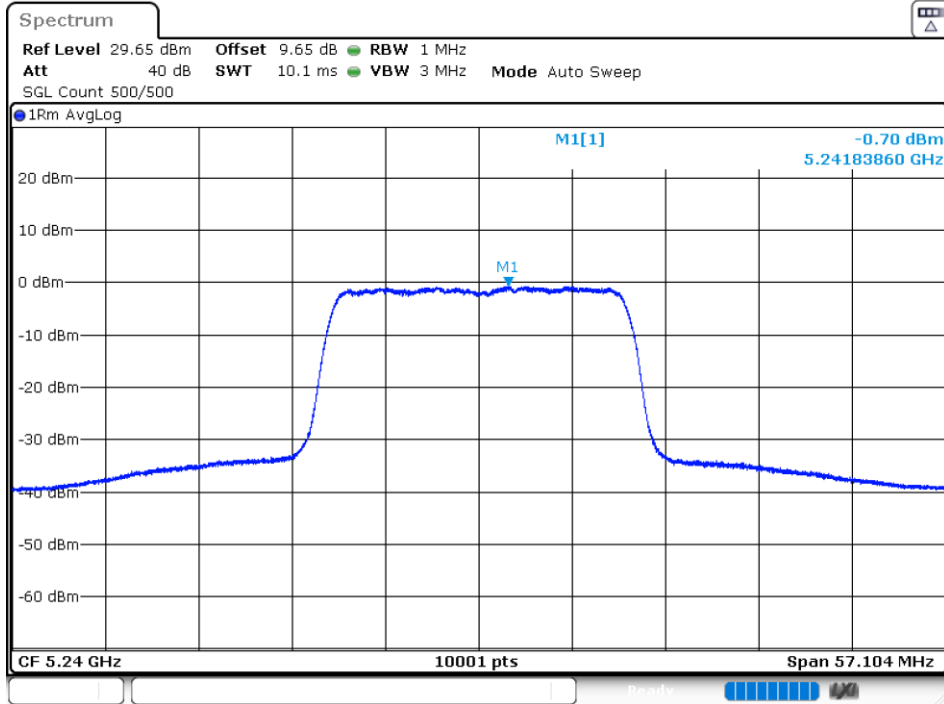

PSD NVNT 802.11n(HT40) 5190MHz Ant1

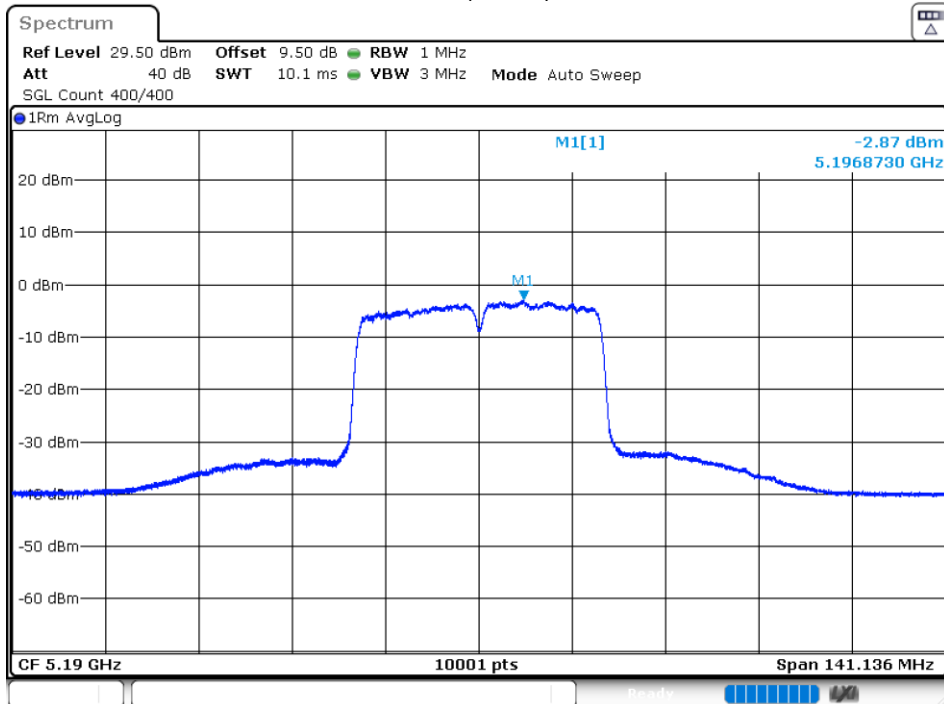

PSD NVNT 802.11n(HT40) 5230MHz Ant1

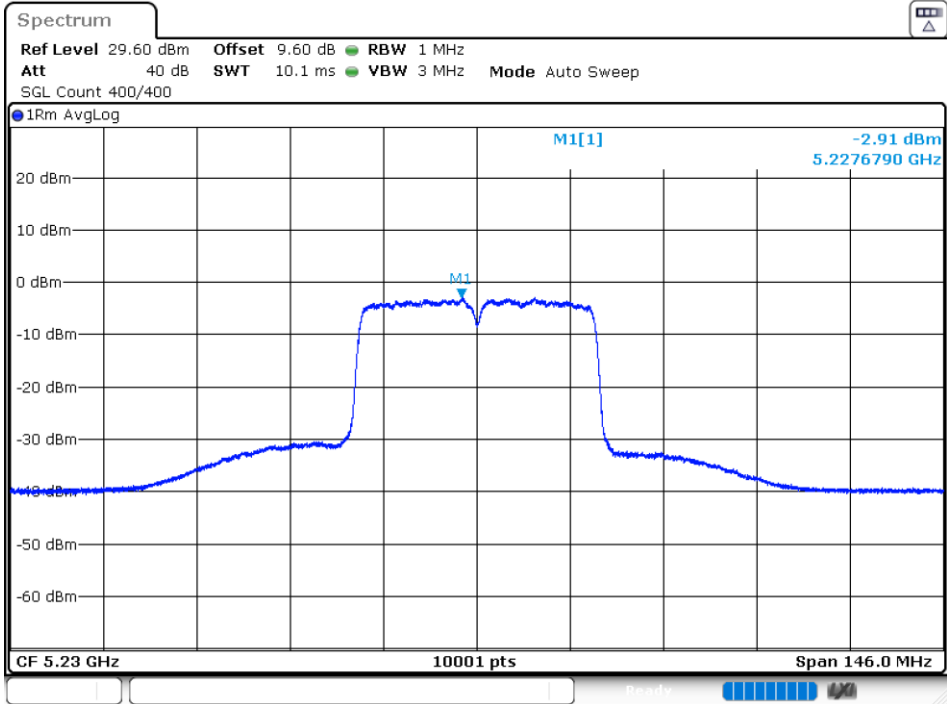

10.5 BAND EDGE

Condition	Mode	Frequency (MHz)	Antenna	Max Value (dBm)	Limit (dBm)	Verdict
NVNT	802.11a	5180	Ant 1	-32.58	-27	Pass
NVNT	802.11a	5240	Ant 1	-44.03	-27	Pass
NVNT	802.11n(HT20)	5180	Ant 1	-34.34	-27	Pass
NVNT	802.11n(HT20)	5240	Ant 1	-46.23	-27	Pass
NVNT	802.11n(HT40)	5190	Ant 1	-27.38	-27	Pass
NVNT	802.11n(HT40)	5230	Ant 1	-45.38	-27	Pass

Band Edge NVNT 802.11a 5180MHz Low Ant1



Band Edge NVNT 802.11a 5240MHz High Ant1

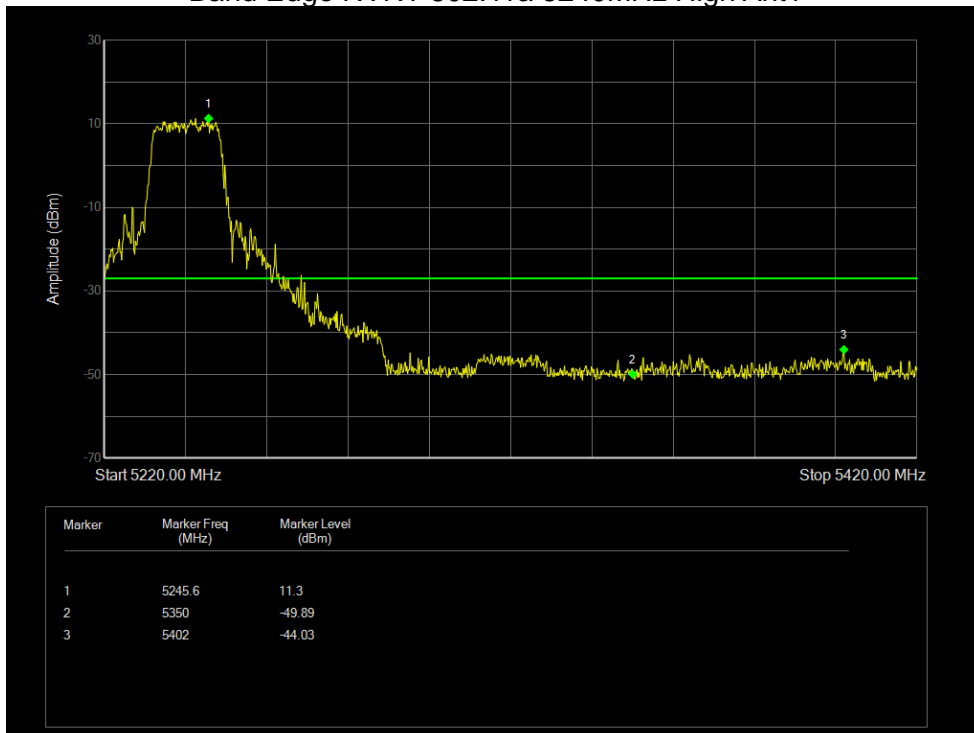

Band Edge NVNT 802.11n(HT20) 5180MHz Low Ant1

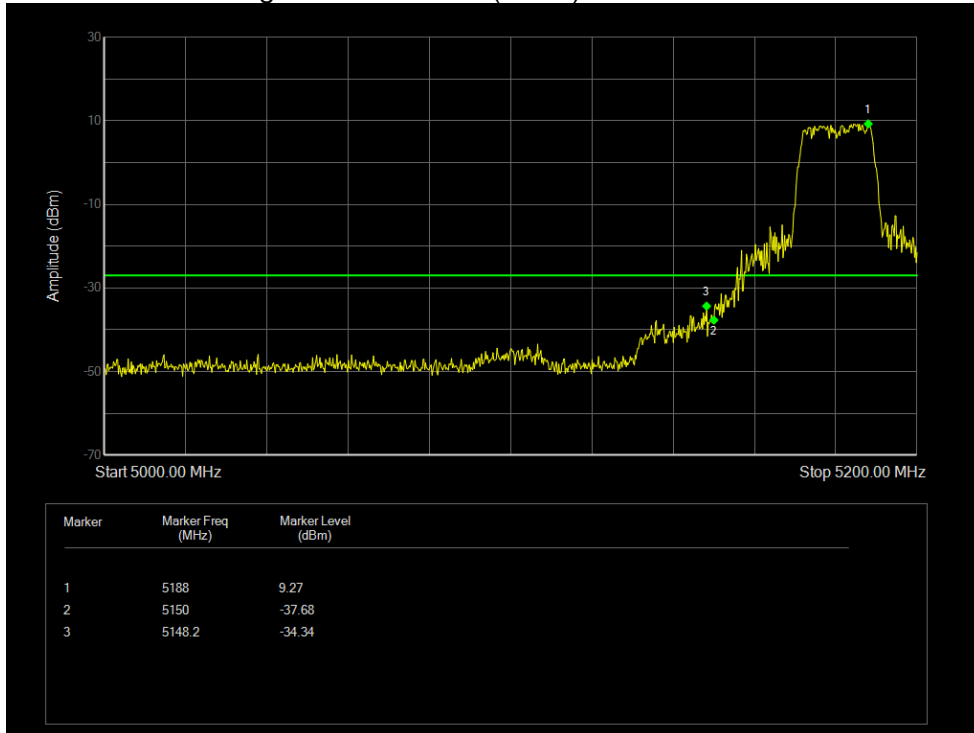

Band Edge NVNT 802.11n(HT20) 5240MHz High Ant1

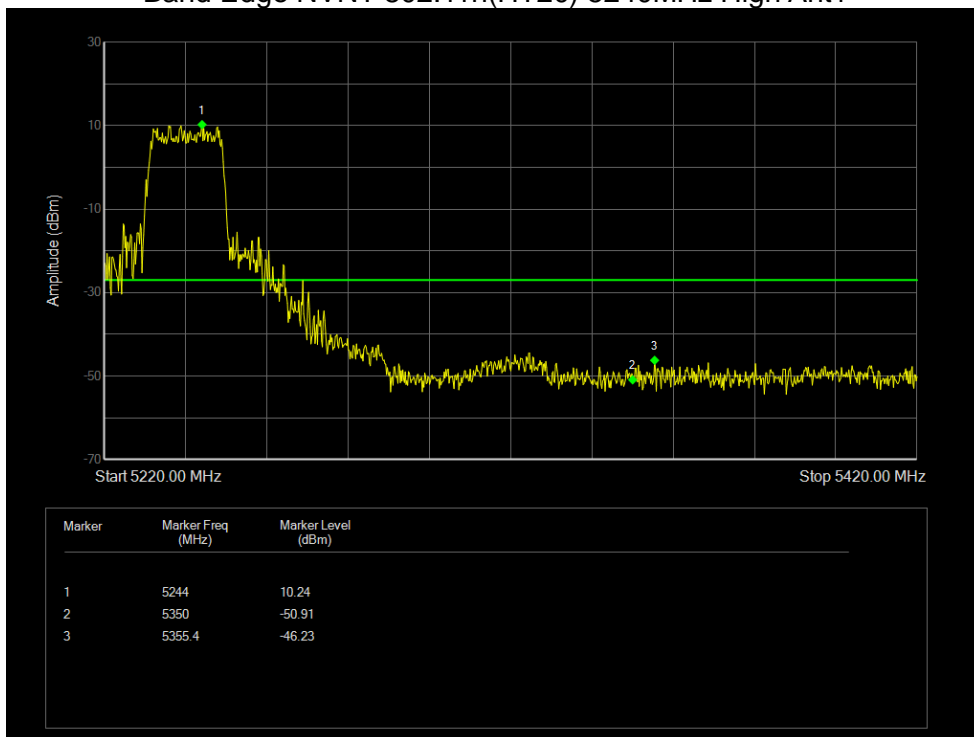

Band Edge NVNT 802.11n(HT40) 5190MHz Low Ant1

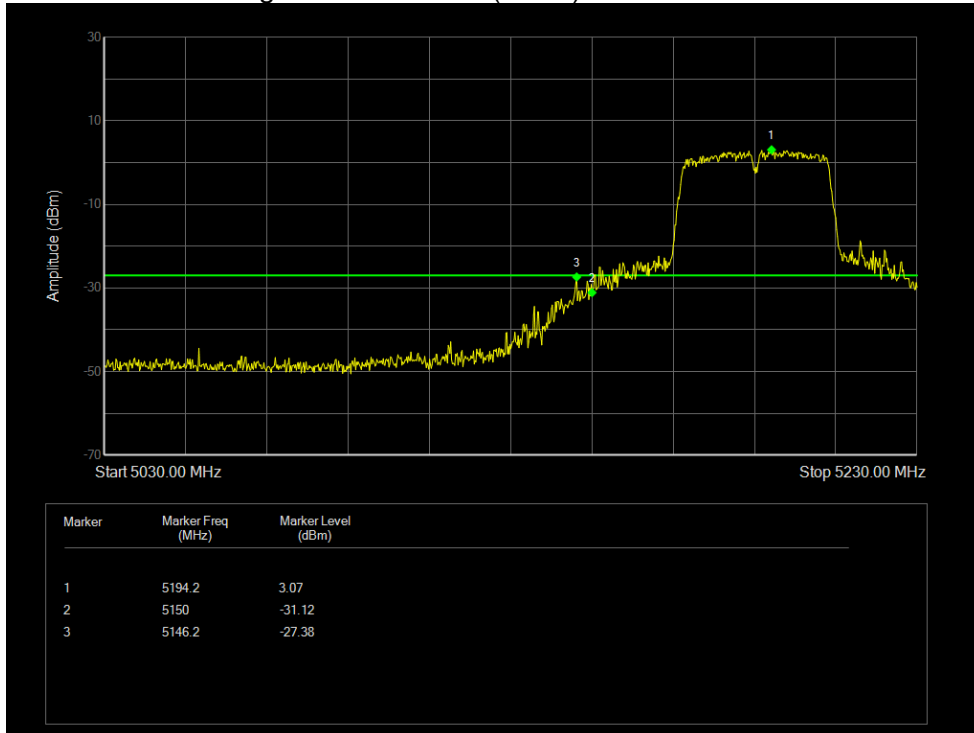

Band Edge NVNT 802.11n(HT40) 5230MHz High Ant1



10.5 CONDUCTED RF SPURIOUS EMISSION

Condition	Mode	Frequency (MHz)	Antenna	Max Value (dBc)	Limit (dBc)	Verdict
NVNT	802.11a	5180	Ant 1	-35.99	-27	Pass
NVNT	802.11a	5200	Ant 1	-36.93	-27	Pass
NVNT	802.11a	5240	Ant 1	-36.03	-27	Pass
NVNT	802.11n(HT20)	5180	Ant 1	-35.75	-27	Pass
NVNT	802.11n(HT20)	5200	Ant 1	-36.74	-27	Pass
NVNT	802.11n(HT20)	5240	Ant 1	-36.86	-27	Pass
NVNT	802.11n(HT40)	5190	Ant 1	-36.51	-27	Pass
NVNT	802.11n(HT40)	5230	Ant 1	-34.95	-27	Pass

Tx. Spurious NVNT 802.11a 5180MHz Ant1 Emission

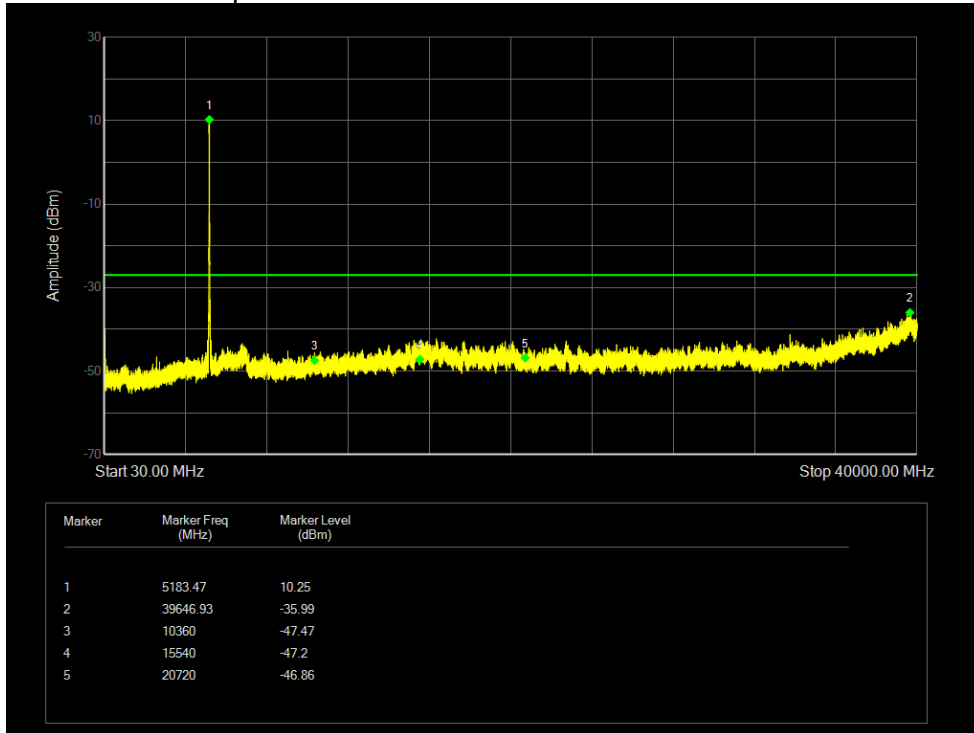

Tx. Spurious NVNT 802.11a 5200MHz Ant1 Emission

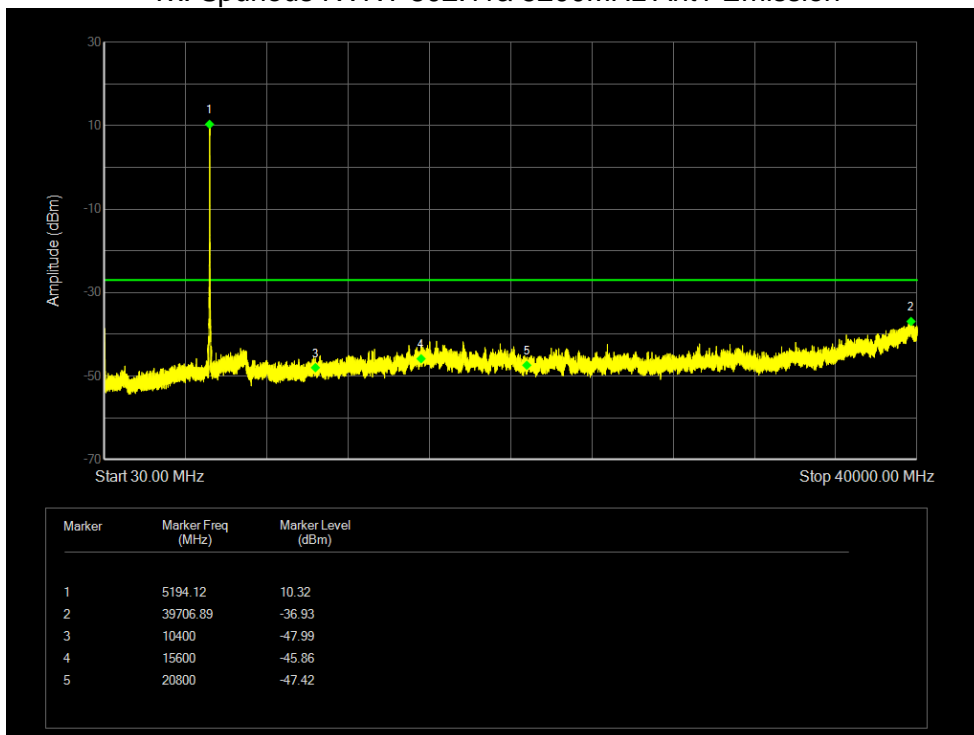

Tx. Spurious NVNT 802.11a 5240MHz Ant1 Emission

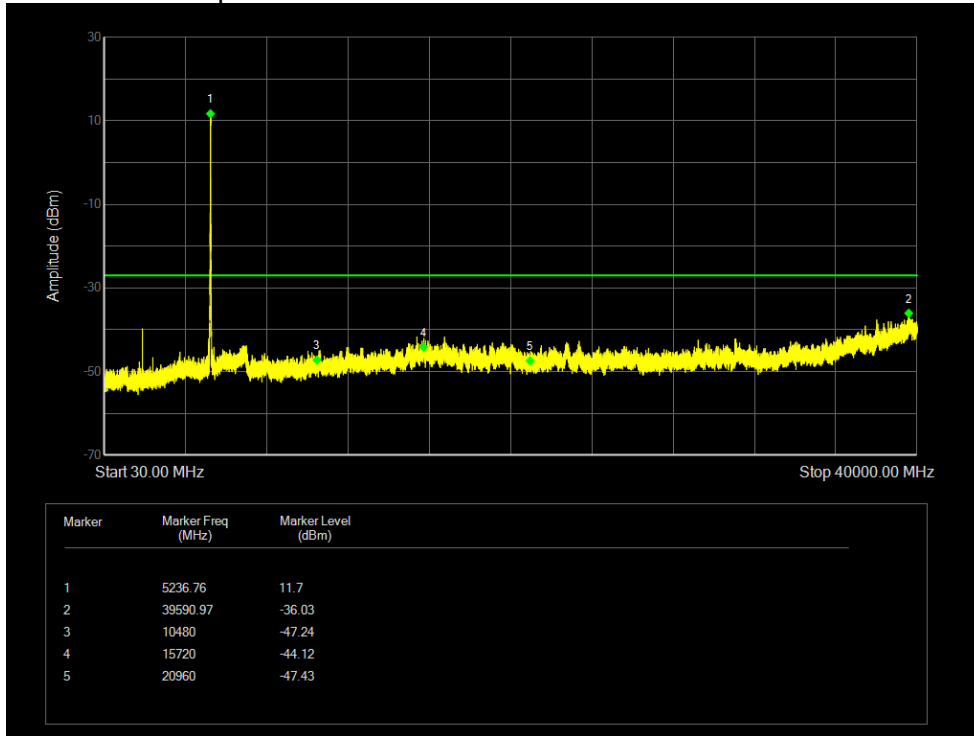

Tx. Spurious NVNT 802.11n(HT20) 5180MHz Ant1 Emission

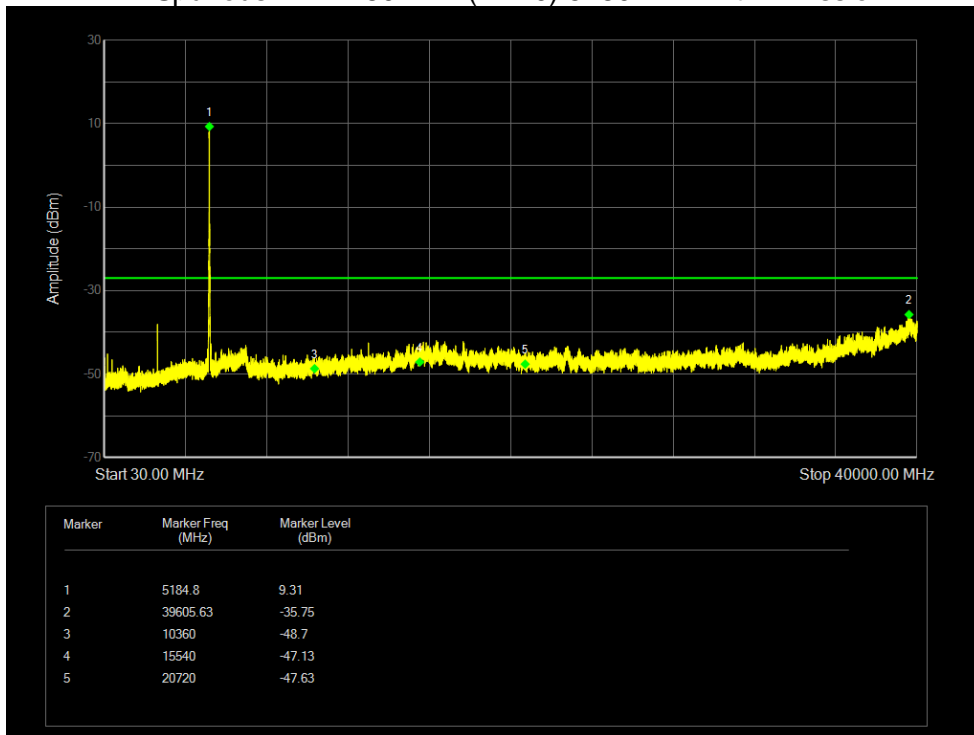

Tx. Spurious NVNT 802.11n(HT20) 5200MHz Ant1 Emission

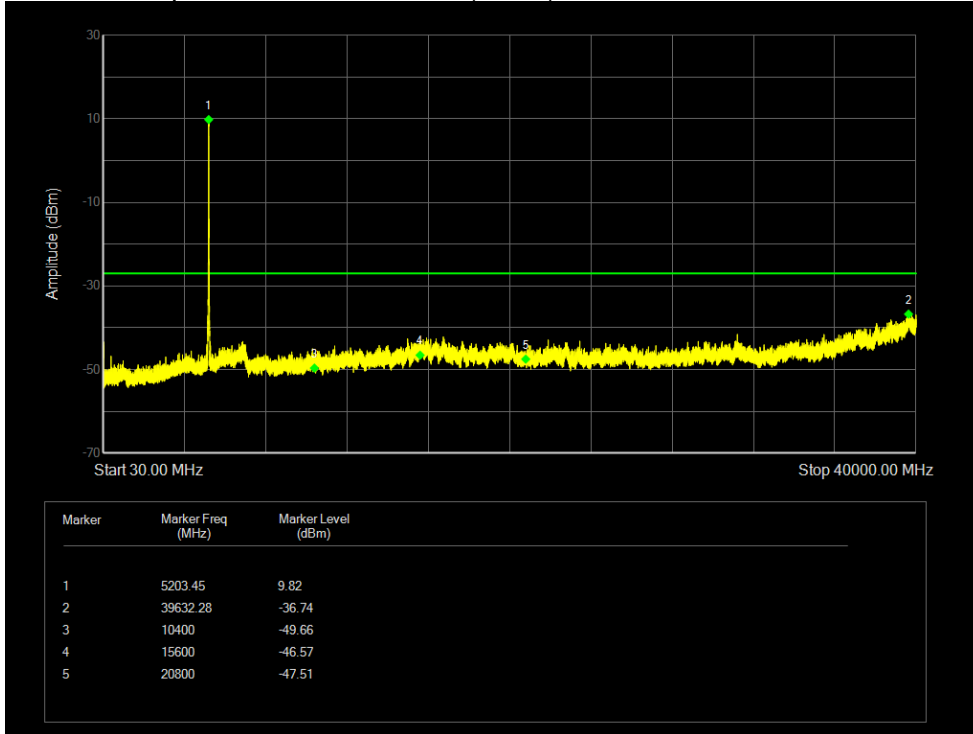

Tx. Spurious NVNT 802.11n(HT20) 5240MHz Ant1 Emission

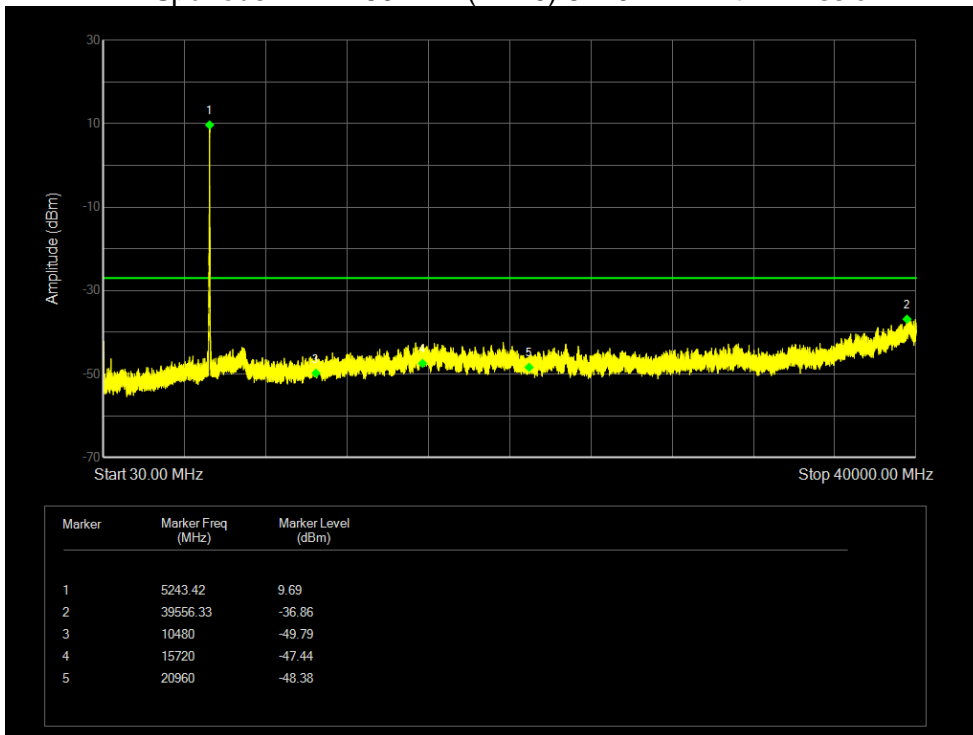

Tx. Spurious NVNT 802.11n(HT40) 5190MHz Ant1 Emission

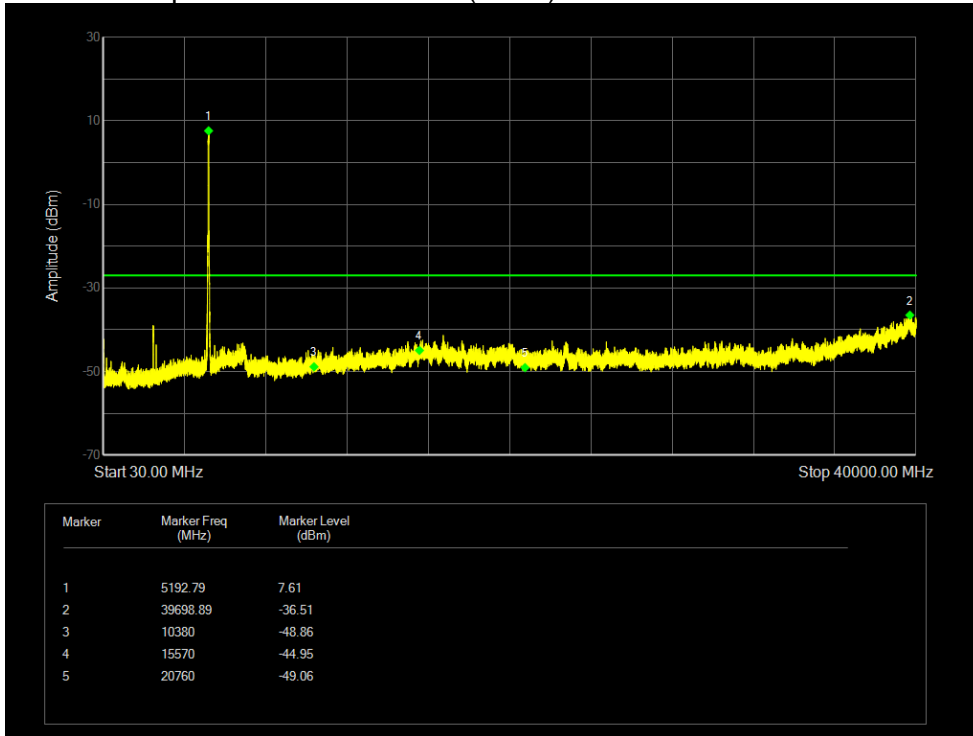

Tx. Spurious NVNT 802.11n(HT40) 5230MHz Ant1 Emission

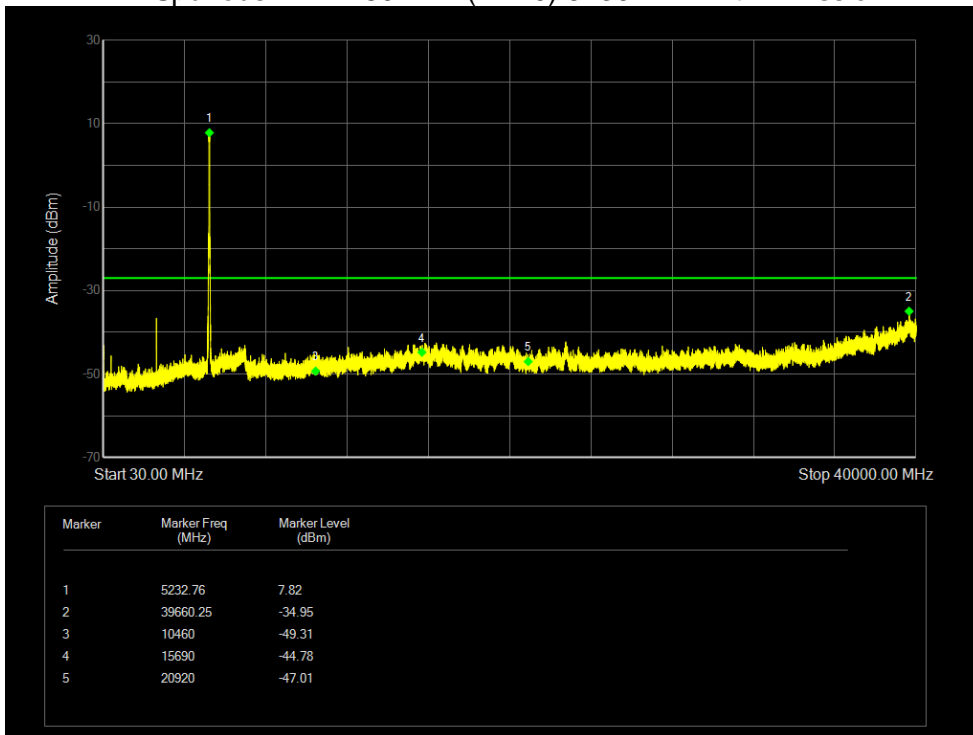

END OF REPORT