



KES Co., Ltd.

3701, 40, Simin-daero 365beon-gil,
Dongan-gu, Anyang-si, Gyeonggi-do, 14057, Korea
Tel: +82-31-425-6200 / Fax: +82-31-424-0450
www.kes.co.kr

Report No.:
KES-EM-21T1084
Page (1) of (22)

EMC TEST REPORT

Test Report No. : KES-EM-21T1084
Date of Issue : Nov. 11, 2021
Product name : InBirdie TEMPO
Model/Type No. : InBirdie TEMPO
Variant Mode : -
Applicant : DMBH Co., Ltd.
Applicant Address : #401-603, Bucheon Techno-park, 655, Pyeongcheon-ro,
Wonmi-gu, Bucheon-si, Gyeonggi-do, Korea
Manufacturer : DMBH Co., Ltd.
Manufacturer Address : #401-603, Bucheon Techno-park, 655, Pyeongcheon-ro,
Wonmi-gu, Bucheon-si, Gyeonggi-do, Korea
FCC ID : 2A3CB-INBIRDIETEMPO
Date of Receipt : Sep. 09, 2021
Test date : Oct. 25, 2021 ~ Oct. 26, 2021
Test Results : **In Compliance** **Not in Compliance**

Tested by

Reviewed by

Dohyun, Ko
EMC Test Engineer

Juwon, Yun
EMC Technical Manager

This report shall not be reproduced except in full, without the written approval of KES Co., Ltd.
The results shown in this test report refer only to the sample(s) tested unless otherwise stated.
The authenticity of the test report, contact shchoi@kes.co.kr



KES Co., Ltd.

3701, 40, Simin-daero 365beon-gil,
Dongan-gu, Anyang-si, Gyeonggi-do, 14057, Korea
Tel: +82-31-425-6200 / Fax: +82-31-424-0450
www.kes.co.kr

Report No.:
KES-EM-21T1084
Page (2) of (22)

REPORT REVISION HISTORY

Date	Test Report No.	Revision History
Nov. 11, 2021	KES-EM-21T1084	Issued

This report shall not be reproduced except in full, without the written approval of KES Co., Ltd. This document may be altered or revised by KES Co., Ltd. personnel only, and shall be noted in the revision section of the document. Any alteration of this document not carried out by KES Co., Ltd. will constitute fraud and shall nullify the document.

This report shall not be reproduced except in full, without the written approval of KES Co., Ltd.
The results shown in this test report refer only to the sample(s) tested unless otherwise stated.
The authenticity of the test report, contact shchoi@kes.co.kr



TABLE OF CONTENTS

1.0	General Product Description.....	4
1.1	Test Voltage & Frequency	5
1.2	Variant Model Differences	5
1.3	Device Modifications	5
1.4	Equipment Under Test.....	5
1.5	Support Equipments	5
1.6	External I/O Cabling	6
1.7	EUT Operating Mode(s)	6
1.8	Configuration.....	7
1.9	Remarks when standards applied	8
1.10	Calibration Details of Equipment Used for Measurement	8
1.11	Test Facility	8
1.12	Measurement Procedure.....	8
1.13	Laboratory Accreditations and Listings	9
2.0	Test Regulations.....	10
2.1	Conducted Emissions at Mains Power Ports	12
2.2	Radiated Electric Field Emissions(Below 1 GHz)	13
2.3	Radiated Electric Field Emissions(Above 1 GHz)	14
APPENDIX A – TEST DATA.....		15
Conducted Emissions at Mains Power Ports.....		15
Radiated Electric Field Emissions(Below 1 GHz)		17
Radiated Electric Field Emissions(Above 1 GHz).....		18
APPENDIX B - Test Setup Photos and Configuration.....		20
Radiated Electric Field Emissions(Below 1 GHz)		21
Radiated Electric Field Emissions(Above 1 GHz)		22

This report shall not be reproduced except in full, without the written approval of KES Co., Ltd.
The results shown in this test report refer only to the sample(s) tested unless otherwise stated.
The authenticity of the test report, contact shchoi@kes.co.kr



KES Co., Ltd.

3701, 40, Simin-daero 365beon-gil,
Dongan-gu, Anyang-si, Gyeonggi-do, 14057, Korea
Tel: +82-31-425-6200 / Fax: +82-31-424-0450
www.kes.co.kr

Report No.:
KES-EM-21T1084
Page (4) of (22)

1.0 General Product Description

Main Specifications of EUT are:

Item	Details
Operating Frequency	Bluetooth : 2.4 GHz Band
Rated voltage	DC 5 V (USB Power)
Port	USB TYPE-C

This report shall not be reproduced except in full, without the written approval of KES Co., Ltd.
The results shown in this test report refer only to the sample(s) tested unless otherwise stated.
The authenticity of the test report, contact shchoi@kes.co.kr



1.1 Test Voltage & Frequency

Unless indicated otherwise on the individual data sheet or test results, the test voltage and frequency was as indicated below.

AC 120 V , 60 Hz

1.2 Variant Model Differences

Not applicable

1.3 Device Modifications

Not applicable

1.4 Equipment Under Test

Description	Model Number	Serial Number	Manufacturer	Remarks
InBirdie TEMPO	InBirdie TEMPO	-	DMBH Co., Ltd.	EUT

1.5 Support Equipments

Description	Model Number	Serial Number	Manufacturer	Remarks
Smartphone	MKQN2KH/A	-	Apple.Inc	-
Adapter	SLU10	-	SoluM Europe GmbH	-

This report shall not be reproduced except in full, without the written approval of KES Co., Ltd.
The results shown in this test report refer only to the sample(s) tested unless otherwise stated.
The authenticity of the test report, contact shchoi@kes.co.kr



1.6 External I/O Cabling

Start		END		Cable Spec.	
Description	I/O Port	Description	I/O Port	Length	Shield
InBirdie TEMPO (EUT)	Wireless	Smartphone	Wireless	-	-
	USB TYPE-C	Adapter	USB	1.8	U

* Unshielded = U, Shielded = S

1.7 EUT Operating Mode(s)

Test mode	operating
Operation	Confirmed the communication between the EUT and the smartphone through 'InBirdie Game' application of the Smartphone

EUT Test operating S/W		
Name	Version	Manufacture Company
InBirdie Game	Ver.s 0123101	-

1.8 Configuration

- AC Main
- DC Main

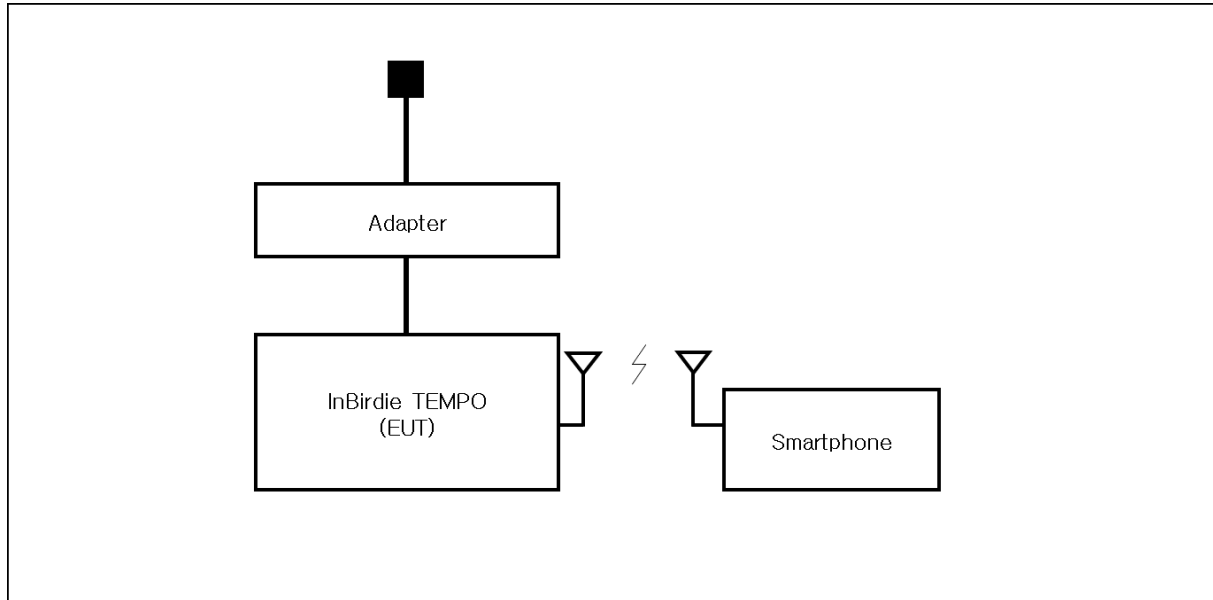

EUT - Smartphone : Bluetooth

1.9 Remarks when standards applied

N/A

1.10 Calibration Details of Equipment Used for Measurement

Test equipment and test accessories are calibrated on regular basis. The maximum time between calibrations is one year or what is recommended by the manufacturer, whichever is less.

1.11 Test Facility

The measurement facility is located at 473-21 Gayeo-ro, Yeosu-si, Gyeonggi-do, 12658, Korea. The sites are constructed in conformance with the requirements of ANSI C63.4:2014 and CISPR 16-1-4:2019

1.12 Measurement Procedure

- Conducted Emissions







The conducted emission levels were measured on each current-carrying line with the spectrum analyzer operating in the CISPR quasi-peak mode (or peak mode if applicable). The initial step in collecting conducted data is a spectrum analyzer peak scan of the measurement range. If the conducted emission exceed the average limit with the instrument set to the quasi-peak mode, the measurements are made in the average mode. The emission spectrum was scanned from 150 kHz to 30 MHz. The highest emission amplitudes relative to the appropriate limits were measured and have been recorded. Quasi-peak readings are distinguished with a "QP".

- Radiated Electric Field Emissions

The test was done at a SEMI ANECHOIC CHAMBER with quasi-peak detector. The final test data was measured using a Quasi-Peak detector below 1GHz at 10 m or 3 m distance and a Peak and Average detector above 1 GHz at 3 m distance. Test was proceeded worst case test mode and cable configuration. Measurements were made with the antenna positioned in both the horizontal and vertical planes of polarization. The antenna height was varied from 1 m to 4 m and the EUT was rotated 360° to find the maximum emitting point for each frequency.

Measurement procedures was In accordance with ANSI C63.4-2014 7.3.3, 7.3.4, 8.3.1.1, 8.3.1.2, 8.3.2.1, 8.3.2.2

1.13 Laboratory Accreditations and Listings

Country	Agency	Scope of Accreditation	Logo
KOREA	RRA	EMI (3 m & 10 m Semi-Aechoic Chamber ,10 m Open Area and conducted test site) EMS (ESD, RS, EFT/Burst, Surge, CS, Magnetic, Dips and interruptions)	 KR0100
International	KOLAS	EMI (3 m & 10 m Semi-Aechoic Chamber , and conducted test site) EMS (ESD, RS, EFT/Burst, Surge, CS, Magnetic, Dips and interruptions)	 KT489
USA	FCC	3 m & 10 m Semi-Aechoic Chamber, 10 m Open Area and Conducted test site to perform FCC Part 15/18 measurements.	 KR0100
Canada	ISED	3 m & 10 m Semi-Aechoic Chamber and Conducted test site	 23298-1
JAPAN	VCCI	Mains Ports Conducted Interference Measurement, Telecommunication Ports Conducted Disturbance Measurement and Radiation 10 meter site, Facility for measuring radiated disturbance above 1 GHz	 R-20056, C-20036 T-20040, G-20057
Europe	TÜV SÜD	EMI (3 m & 10 m Semi-Aechoic Chamber , 10 m Open Area and conducted test site) EMS (ESD, RS, EFT/Burst, Surge, CS, Magnetic, Dips and interruptions)	 CARAT 001633 0004

This report shall not be reproduced except in full, without the written approval of KES Co., Ltd.
The results shown in this test report refer only to the sample(s) tested unless otherwise stated.
The authenticity of the test report, contact shchoi@kes.co.kr

2.0 Test Regulations

The emissions tests were performed according to following regulations:

EMC – Directive 2014/30/EU

EN 61000-6-3:2011

EN 61000-6-1:2007

EN 61000-6-4:2007 +A1:2011

EN 61000-6-2:2005

EN 55011:2007 +A1:2010

Group 1

Group 2

Class A

Class B

EN 55014-1:2006 +A2:2011

EN 55014-2:1997 +A2:2008

EN 55015:2013

EN 55032:2015

Class A

Class B

EN 55024:2010

EN 50130-4:2011 +A1:2014

EN 61000-3-2:2014

EN 61000-3-3:2013

EN 61326-1:2013



KES Co., Ltd.

3701, 40, Simin-daero 365beon-gil,
Dongan-gu, Anyang-si, Gyeonggi-do, 14057, Korea
Tel: +82-31-425-6200 / Fax: +82-31-424-0450
www.kes.co.kr

Report No.:
KES-EM-21T1084
Page (11) of (22)

-
- | | | |
|--|----------------------------------|---|
| <input type="checkbox"/> VCCI V-3 / 2015.04 | <input type="checkbox"/> Class A | <input type="checkbox"/> Class B |
| <input type="checkbox"/> AS/NZS:2013 | <input type="checkbox"/> Class A | <input type="checkbox"/> Class B |
| <input checked="" type="checkbox"/> 47 CFR Part 15, Subpart B | | |
| <input type="checkbox"/> CISPR 22:2009 +A1:2010 | <input type="checkbox"/> Class A | <input type="checkbox"/> Class B |
| <input checked="" type="checkbox"/> ANSI C63.4-2014 | <input type="checkbox"/> Class A | <input checked="" type="checkbox"/> Class B |
| <input type="checkbox"/> IC Regulation ICES-003 : 2016 | | |
| <input type="checkbox"/> CAN/CSA CISPR 22-10 | <input type="checkbox"/> Class A | <input type="checkbox"/> Class B |
| <input type="checkbox"/> ANSI C63.4-2014 | <input type="checkbox"/> Class A | <input type="checkbox"/> Class B |
| <input type="checkbox"/> RE- Directive 2014/53/EU | | |
| <input type="checkbox"/> EN 301 489-1 V1.9.2 | | |
| <input type="checkbox"/> Equipment for fixed use | | |
| <input type="checkbox"/> Equipment for vehicular use | | |
| <input type="checkbox"/> Equipment for portable use | | |
| <input type="checkbox"/> EN 301 489-3 V1.6.1 | | |
| <input type="checkbox"/> EN 301 489-17 V2.2.1 | | |
| <input type="checkbox"/> EN 60945:2002 | | |

This report shall not be reproduced except in full, without the written approval of KES Co., Ltd.
The results shown in this test report refer only to the sample(s) tested unless otherwise stated.
The authenticity of the test report, contact shchoi@kes.co.kr

2.1 Conducted Emissions at Mains Power Ports

Test Date

Oct. 25, 2021

Test Location

Electro wave Shieldroom #6

Test Equipment

Used	Description	Model Number	Manufacturer	Serial Number	Cal. Due	calibration interval
<input checked="" type="checkbox"/>	EMI Test S/W	EMC32	R & S	9.12.00	-	-
<input checked="" type="checkbox"/>	EMI TEST RECEIVER	ESR3	R & S	101783	01, 15, 2022	1 Year
<input checked="" type="checkbox"/>	LISN	ENV216	R & S	101787	12, 29, 2021	1 Year
<input type="checkbox"/>	LISN	ESH2-Z5	R & S	100450	12, 29, 2021	1 Year
<input checked="" type="checkbox"/>	PULSE LIMITER	ESH3-Z2	R & S	101915	12, 29, 2021	1 Year

Test Conditions

Temperature: (22,8 ± 0,1) °C
 Relative Humidity: (46,3 ± 0,1) % R.H.

Frequency Range of Measurement

150 kHz to 30 MHz

Instrument Settings

IF Band Width: 9 kHz

Test Results

The requirements are:

- PASS
- NOT PASS
- NOT APPLICABLE

Remarks

See Appendix A for test data.



2.2 Radiated Electric Field Emissions(Below 1 GHz)

Test Date

Oct. 26, 2021

Test Location

OPEN AREA TEST SITE #2

SEMI ANECHOIC CHAMBER #4

Test Equipment

Used	Description	Model Number	Manufacturer	Serial Number	Cal. Due	calibration interval
<input checked="" type="checkbox"/>	EMI Test S/W	EP5/RE	TOYO Corporation	6.0.0	-	-
<input checked="" type="checkbox"/>	EMI TEST RECEIVER	ESU26	R & S	100551	04, 01, 2022	1 Year
<input checked="" type="checkbox"/>	AMPLIFIER	SCU 01	R & S	100603	11, 25, 2021	1 Year
<input checked="" type="checkbox"/>	TRILOG-BROADBAND ANTENNA	VULB9163	Schwarzbeck	715	12, 08, 2022	2 Year
<input checked="" type="checkbox"/>	ATTENUATOR	8491A	HP	32173	03, 10, 2022	1 Year

Test Conditions

Temperature: (22,5 ± 0,1) °C

Relative Humidity: (45,6 ± 0,1) % R.H.

Frequency Range of Measurement

30 MHz to 1 GHz

Instrument Settings

IF Band Width: 120 kHz

Test Results

The requirements are:

- PASS
- NOT PASS
- NOT APPLICABLE

Remarks

See Appendix A for test data.

2.3 Radiated Electric Field Emissions(Above 1 GHz)

Test Date

Oct. 26, 2021

Test Location

SEMI ANECHOIC CHAMBER #4

Test Equipment

Used	Description	Model Number	Manufacturer	Serial Number	Cal. Due	calibration interval
<input checked="" type="checkbox"/>	EMI Test S/W	EP5/RE	TOYO Corporation	6.0.0	-	-
<input checked="" type="checkbox"/>	EMI TEST RECEIVER	ESU26	R & S	100551	04, 01, 2022	1 Year
<input checked="" type="checkbox"/>	PREAMPLIFIER	8449B	AGILENT	3008A01742	12, 29, 2021	1 Year
<input checked="" type="checkbox"/>	HORN ANTENNA	BBHA 9120D	SCHWARZBECK	9120D-1802	12, 14, 2021	1 Year

Test Conditions

Temperature: (22,5 ± 0,2) °C
 Relative Humidity: (45,6 ± 0,1) % R.H.

Frequency Range of Measurement

1 GHz to 12,5 GHz

Instrument Settings

IF Band Width: 1 MHz

Test Results

The requirements are:

- PASS
- NOT PASS
- NOT APPLICABLE

Remarks

See Appendix A for test data.

APPENDIX A – TEST DATA

Conducted Emissions at Mains Power Ports

HOT LINE

Common Information

Test Description: Conducted Emission
 Model No.: InBirdie TEMPO
 Phase:
 Mode:
 Operator Name: KES

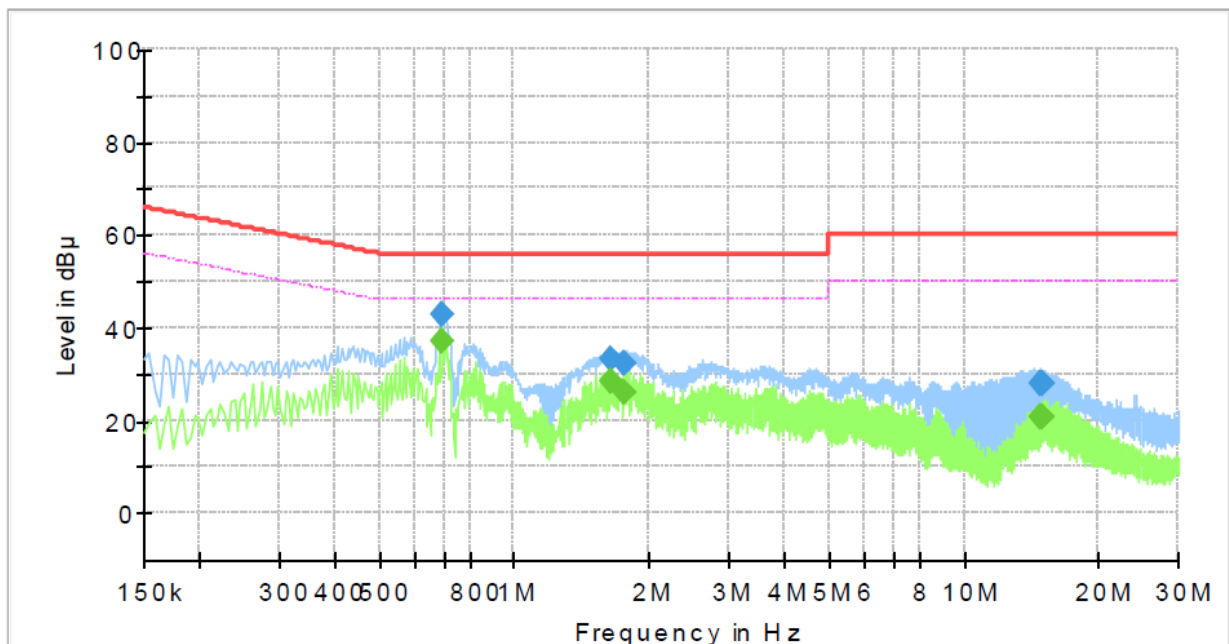

Final Result

Frequency (MHz)	QuasiPeak (dBµV)	Average (dBµV)	Limit (dBµV)	Margin (dB)	Meas. Time (ms)	Bandwidth (kHz)	Line	Corr. (dB)
0.694000	---	37.17	46.00	8.83	1000.0	9.000	L1	20.3
0.694000	42.63	---	56.00	13.37	1000.0	9.000	L1	20.3
1.650000	---	28.26	46.00	17.74	1000.0	9.000	L1	20.6
1.650000	33.24	---	56.00	22.76	1000.0	9.000	L1	20.6
1.754000	---	26.10	46.00	19.90	1000.0	9.000	L1	20.6
1.754000	32.34	---	56.00	23.66	1000.0	9.000	L1	20.6
14.854000	---	20.56	50.00	29.44	1000.0	9.000	L1	20.6
14.854000	28.08	---	60.00	31.92	1000.0	9.000	L1	20.6
14.902000	---	20.70	50.00	29.30	1000.0	9.000	L1	20.6
14.902000	28.06	---	60.00	31.94	1000.0	9.000	L1	20.6

This report shall not be reproduced except in full, without the written approval of KES Co., Ltd.
 The results shown in this test report refer only to the sample(s) tested unless otherwise stated.
 The authenticity of the test report, contact shchoi@kes.co.kr

NEUTRAL LINE

Common Information

Test Description: Conducted Emission
 Model No.: InBirdie TEMPO
 Phase:
 Mode:
 Operator Name: KES

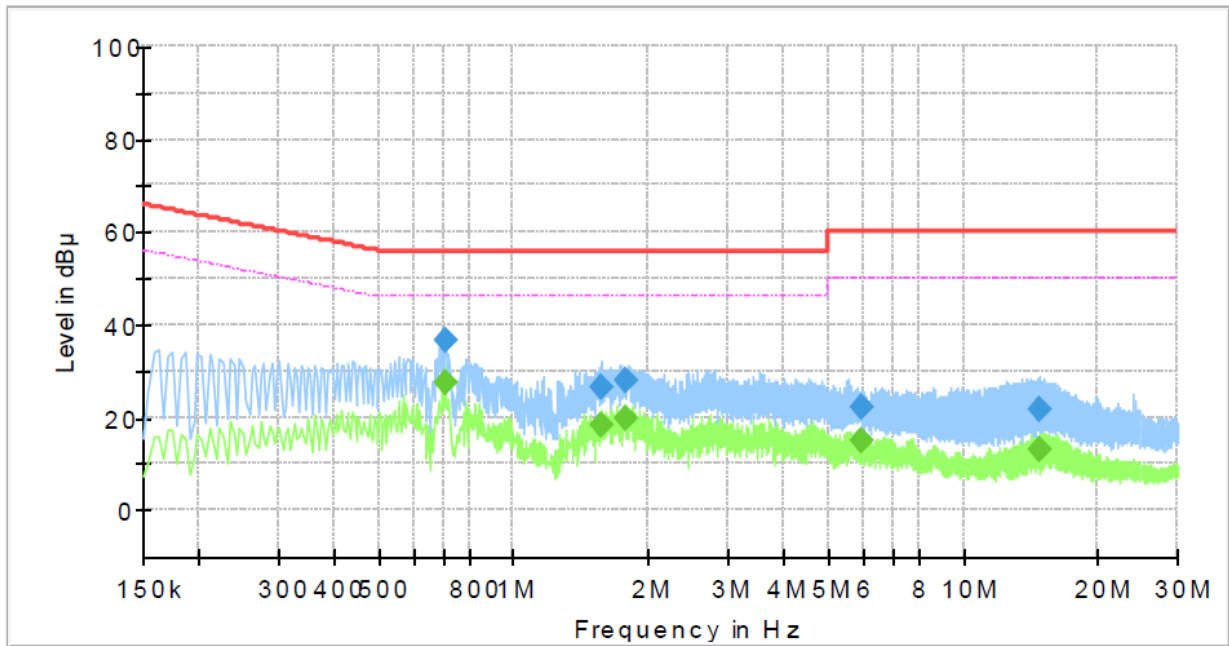

Final Result

Frequency (MHz)	QuasiPeak (dBµV)	Average (dBµV)	Limit (dBµV)	Margin (dB)	Meas. Time (ms)	Bandwidth (kHz)	Line	Corr. (dB)
0.706000	---	27.42	46.00	18.58	1000.0	9.000	N	20.3
0.706000	36.51	---	56.00	19.49	1000.0	9.000	N	20.3
1.562000	---	18.21	46.00	27.79	1000.0	9.000	N	20.6
1.562000	26.31	---	56.00	29.69	1000.0	9.000	N	20.6
1.778000	---	19.79	46.00	26.21	1000.0	9.000	N	20.6
1.778000	27.94	---	56.00	28.06	1000.0	9.000	N	20.6
5.918000	---	14.86	50.00	35.14	1000.0	9.000	N	20.0
5.918000	22.04	---	60.00	37.96	1000.0	9.000	N	20.0
14.878000	---	12.96	50.00	37.04	1000.0	9.000	N	20.6
14.878000	21.55	---	60.00	38.45	1000.0	9.000	N	20.6

◆ Calculation

QuasiPeak [dBµV] / CAverage [dBµV] = Reading Value [dBµV] + Corr. [dB]

QuasiPeak / CAverage : The Final Value

Reading Value : Not shown in the table.

Corr. : Correction values (LISN FACTOR + (Cable Loss + Pulse Limiter FACTOR))

This report shall not be reproduced except in full, without the written approval of KES Co., Ltd.
 The results shown in this test report refer only to the sample(s) tested unless otherwise stated.
 The authenticity of the test report, contact shchoi@kes.co.kr



Radiated Electric Field Emissions(Below 1 GHz)

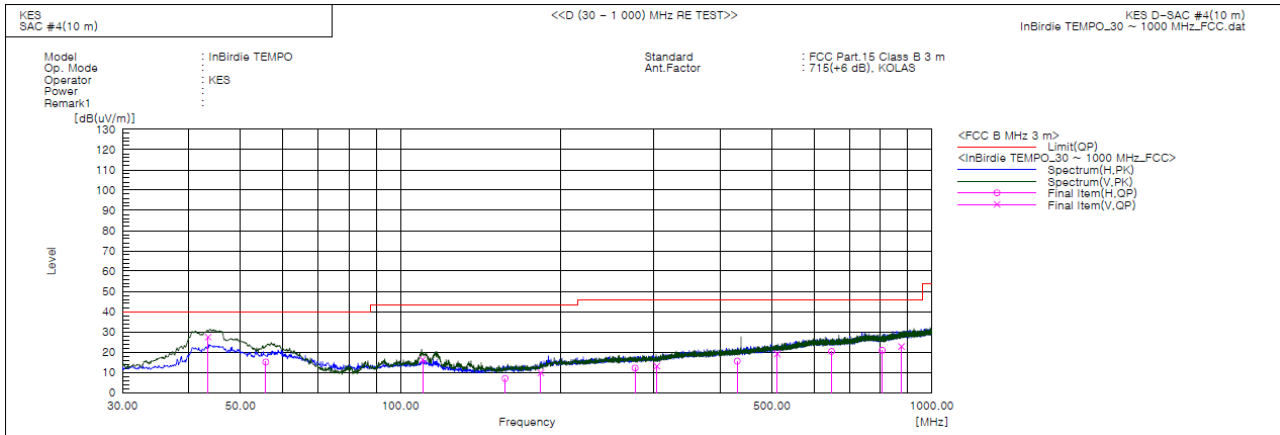

Final Result

No.	Frequency [MHz]	(P)	Reading QP [dB(uV)]	c.f [dB(1/m)]	Result QP [dB(uV/m)]	Limit QP [dB(uV/m)]	Margin QP [dB]	Height [cm]	Angle [deg]	Remark
1	43.459	V	49.5	-22.1	27.4	40.0	12.6	100.0	276.0	
2	55.826	H	37.1	-22.0	15.1	40.0	24.9	400.0	115.0	
3	110.146	V	39.3	-22.9	16.4	43.5	27.1	109.0	192.0	
4	157.313	H	32.4	-25.4	7.0	43.5	36.5	400.0	96.0	
5	183.745	V	33.5	-23.7	9.8	43.5	33.7	100.0	196.0	
6	276.380	H	31.7	-19.6	12.1	46.0	33.9	233.0	171.0	
7	303.904	V	31.9	-18.8	13.1	46.0	32.9	153.0	308.0	
8	430.489	H	30.4	-14.9	15.5	46.0	30.5	400.0	130.0	
9	511.605	V	31.8	-12.7	19.1	46.0	26.9	159.0	270.0	
10	647.648	H	29.9	-9.6	20.3	46.0	25.7	400.0	92.0	
11	806.052	H	29.0	-8.1	20.9	46.0	25.1	396.0	290.0	
12	876.083	V	28.9	-6.1	22.8	46.0	23.2	100.0	329.0	

◆ Calculation – SAC #4(10 m)

$$\text{Result(QP)} [dB(\mu V/m)] = (\text{Reading(QP)}[dB(\mu V)] + \text{c.f}[dB(1/m)])$$

$$\text{Margin(QP)}[dB] = \text{Limit}[dB(\mu V/m)] - \text{Result(QP)} [dB(\mu V/m)]$$

Reading(QP) : Reading value, Result(QP) : Reading value + Factor value

Limit(QP) : Limit value, c.f : (ANT Factor + Cable Loss - Preamp Factor), Margin: Margin value

This report shall not be reproduced except in full, without the written approval of KES Co., Ltd.
 The results shown in this test report refer only to the sample(s) tested unless otherwise stated.
 The authenticity of the test report, contact shchoi@kes.co.kr



KES Co., Ltd.

3701, 40, Simin-daero 365beon-gil,
 Dongan-gu, Anyang-si, Gyeonggi-do, 14057, Korea
 Tel: +82-31-425-6200 / Fax: +82-31-424-0450
 www.kes.co.kr

Report No.:
 KES-EM-21T1084
 Page (18) of (22)

Radiated Electric Field Emissions(Above 1 GHz)

- (1 ~ 5) GHz

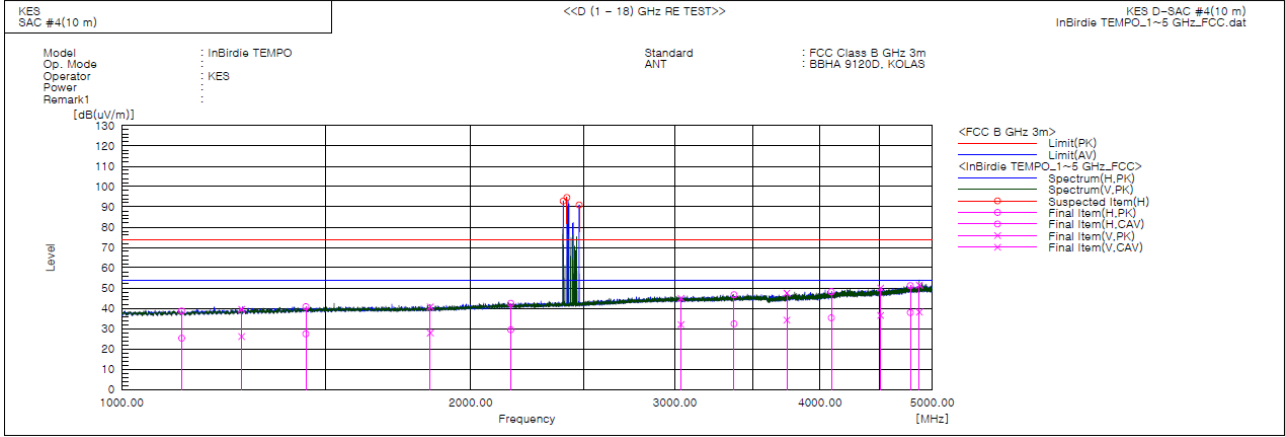

Final Result

No.	Frequency [MHz]	(P)	Reading PK [dB(uV)]	Reading CAV [dB(uV)]	c.f [dB(1/m)]	Result PK [dB(uV/m)]	Result CAV [dB(uV/m)]	Limit PK [dB(uV/m)]	Limit AV [dB(uV/m)]	Margin PK [dB]	Margin CAV [dB]	Height [cm]	Angle [deg]	Remark
1	1126.632	H	42.0	28.6	-3.3	38.7	25.3	74.0	54.0	35.3	28.7	283.0	212.0	
2	1268.521	V	41.9	28.5	-2.4	39.5	26.1	74.0	54.0	34.5	27.9	100.0	60.0	
3	1441.063	H	42.1	28.7	-1.3	40.8	27.4	74.0	54.0	33.2	26.6	100.0	146.0	
4	1845.327	V	39.9	27.1	0.8	40.7	27.9	74.0	54.0	33.3	26.1	100.0	171.0	
5	2165.478	H	40.0	26.9	2.5	42.5	29.4	74.0	54.0	31.5	24.6	400.0	175.0	
6	3035.263	V	38.1	25.1	6.9	45.0	32.0	74.0	54.0	29.0	22.0	142.0	79.0	
7	3373.451	H	38.5	24.2	8.2	46.7	32.4	74.0	54.0	27.3	21.6	393.0	205.0	
8	3744.551	V	37.7	24.4	9.8	47.5	34.2	74.0	54.0	26.5	19.8	100.0	38.0	
9	4091.014	H	36.5	23.6	11.7	48.2	35.3	74.0	54.0	25.8	18.7	100.0	98.0	
10	4510.904	V	36.6	23.1	13.4	50.0	36.5	74.0	54.0	24.0	17.5	127.0	289.0	
11	4787.053	H	36.3	23.0	14.9	51.2	37.9	74.0	54.0	22.8	16.1	400.0	194.0	
12	4872.598	V	36.2	22.9	15.3	51.5	38.2	74.0	54.0	22.5	15.8	100.0	324.0	
13	2402.500	H	-----	-----	3.9	-----	-----	74.0	54.0	-----	-----	100.0	273.0	
14	2420.500	H	-----	-----	4.0	-----	-----	74.0	54.0	-----	-----	100.0	135.0	
15	2480.000	H	-----	-----	4.3	-----	-----	74.0	54.0	-----	-----	100.0	139.0	

* Fundamental Frequency: 2.4 GHz Band

This report shall not be reproduced except in full, without the written approval of KES Co., Ltd.
 The results shown in this test report refer only to the sample(s) tested unless otherwise stated.
 The authenticity of the test report, contact shchoi@kes.co.kr



KES Co., Ltd.

3701, 40, Simin-daero 365beon-gil,
 Dongan-gu, Anyang-si, Gyeonggi-do, 14057, Korea
 Tel: +82-31-425-6200 / Fax: +82-31-424-0450
 www.kes.co.kr

Report No.:
 KES-EM-21T1084
 Page (19) of (22)

- (5 ~ 12,5) GHz

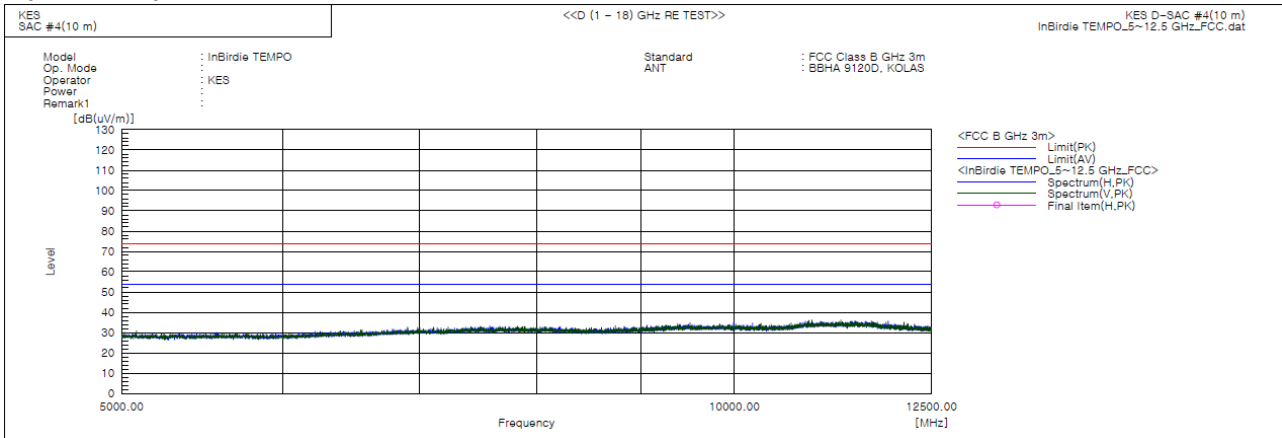

* No spurious emission were detected above 5 GHz.

◆ Calculation

$$\text{Result(PK/CAV)} [\text{dB}(\mu\text{V}/\text{m})] = (\text{Reading(PK/CAV)}[\text{dB}(\mu\text{V})] + c.f[\text{dB}(1/\text{m})])$$

$$\text{Margin(PK/CAV)}[\text{dB}] = \text{Limit}[\text{dB}(\mu\text{V}/\text{m})] - \text{Result(PK/CAV)} [\text{dB}(\mu\text{V}/\text{m})]$$

Reading(PK/CAV) : Reading value, Result(PK/CAV) : Reading value + Factor value

Limit(QP) : Limit value, c.f : (ANT Factor + Cable Loss - Preamp Factor), Margin: Marjin value

This report shall not be reproduced except in full, without the written approval of KES Co., Ltd.
 The results shown in this test report refer only to the sample(s) tested unless otherwise stated.
 The authenticity of the test report, contact shchoi@kes.co.kr