

TEST REPORT



Report No.: TW2203156-01E  
File Reference No.: 2022-04-14

Applicant: Yuhong Electronics (Shenzhen) Co., LTD

Product: AIOJET

Model No.: AIOJet G1P

Trademark: SHO-U

Test Standards: FCC Part 15.247

Test Result: It is herewith confirmed and found to comply with the requirements set up by ANSI C63.10, FCC Part 15.247 for the evaluation of electromagnetic compatibility

Approved By

Handwritten signature of Terry Tang in black ink.

Terry Tang

Manager

Dated: April 14, 2022

**Results appearing herein relate only to the sample tested**

**The technical reports is issued errors and omissions exempt and is subject to withdrawal at**

**SHENZHEN TIMEWAY TESTING LABORATORIES**

Zone C, 1st Floor, Block B, Jun Xiang Da Building, Zhongshan Park Road West, Tong Le Village, Nanshan District, Shenzhen, China

Tel (755) 83448688, Fax (755) 83442996, E-Mail:info@timeway-lab.com



### **Special Statement:**

The testing quality ability of our laboratory meet with "Quality Law of People's Republic of China" Clause 19.

The testing quality system of our laboratory meet with ISO/IEC-17025 requirements, which is approved by CNAS. This approval result is accepted by MRA of APLAC.

Our test facility is recognized, certified, or accredited by the following organizations:

#### **CNAS-LAB Code: L2292**

The EMC Laboratory has been assessed and in compliance with CNAS-CL01 accreditation criteria for testing Laboratories (identical to ISO/IEC 17025:2017 General Requirements) for the Competence of testing Laboratories.

#### **FCC-Registration No.: 744189**

The EMC Laboratory has been registered and fully described in a report filed with the (FCC) Federal Communications commission. The acceptance letter from the FCC is maintained in our files. Registration No.: 744189.

#### **Industry Canada (IC) —Registration No.:5205A**

The EMC Laboratory has been registered by Certification and Engineering Bureau of Industry Canada for radio equipment testing with Registration No.: 5205A.

#### **A2LA (Certification Number:5013.01)**

The EMC Laboratory has been accredited by the American Association for Laboratory Accreditation (A2LA). Certification Number:5013.01

The report refers only to the sample tested and does not apply to the bulk.

This report is issued in confidence to the client and it will be strictly treated as such by the SHENZHEN TIMEWAY TESTING LABORATORIES. It may not be reproduced rather in its entirety or in part and it may not be used for adverting. The client to whom the report is issued may, however, show or send it . or a certified copy there of prepared by the SHENZHEN TIMEWAY TESTING LABORATORIES. to his customer. Supplier or others persons directly concerned. SHENZHEN TIMEWAY TESTING LABORATORIES. will not, without the consent of the client enter into any discussion of correspondence with any third party concerning the contents of the report.

In the event of the improper use of the report. The SHENZHEN TIMEWAY TESTING LABORATORIES. reserves the rights to withdraw it and to adopt any other remedies which may be appropriate.



Test Report Conclusion  
Content

<b>1.0</b>	<b>General Details</b> .....	4
1.1	Test Lab Details.....	4
1.2	Applicant Details.....	4
1.3	Description of EUT .....	4
1.4	Submitted Sample.....	5
1.5	Test Duration.....	5
1.6	Test Uncertainty.....	5
1.7	Test By.....	5
<b>2.0</b>	<b>List of Measurement Equipment</b> .....	6
<b>3.0</b>	<b>Technical Details</b> .....	7
3.1	Summary of Test Results.....	7
3.2	Test Standards.....	7
<b>4.0</b>	<b>EUT Modification</b> .....	7
<b>5.0</b>	<b>Power Line Conducted Emission Test</b> .....	8
5.1	Schematics of the Test.....	8
5.2	Test Method and Test Procedure.....	8
5.3	Configuration of the EUT.....	8
5.4	EUT Operating Condition.....	9
5.5	Conducted Emission Limit.....	9
5.6	Test Result.....	9
<b>6.0</b>	<b>Radiated Emission test</b> .....	12
6.1	Test Method and Test Procedure.....	12
6.2	Configuration of the EUT.....	13
6.3	EUT Operation Condition.....	13
6.4	Radiated Emission Limit.....	13
7.0	20dB Bandwidth .....	20
8.0	Maximum Output Power.....	32
9.0	Carrier Frequency Separation.....	35
10.0	Number of Hopping Channel.....	39
11.0	Time of Occupancy (Dwell Time).....	43
12.0	Out of Band Measurement.....	48
13.0	Antenna Requirement.....	62
14.0	FCC ID Label.....	63
15.0	Photo of Test Setup and EUT View.....	64

The report refers only to the sample tested and does not apply to the bulk.

This report is issued in confidence to the client and it will be strictly treated as such by the SHENZHEN TIMEWAY TESTING LABORATORIES. It may not be reproduced rather in its entirety or in part and it may not be used for advertising. The client to whom the report is issued may, however, show or send it, or a certified copy thereof prepared by the SHENZHEN TIMEWAY TESTING LABORATORIES, to his customer, Supplier or others persons directly concerned. SHENZHEN TIMEWAY TESTING LABORATORIES, will not, without the consent of the client enter into any discussion of correspondence with any third party concerning the contents of the report.

In the event of the improper use of the report. The SHENZHEN TIMEWAY TESTING LABORATORIES, reserves the rights to withdraw it and to adopt any other remedies which may be appropriate.



## 1.0 General Details

### 1.1 Test Lab Details

Name : SHENZHEN TIMEWAY TESTING LABORATORIES.  
Address: Zone C, 1st Floor, Block B, Jun Xiang Da Building, Zhongshan Park Road West, Tong Le Village, Nanshan District, Shenzhen, China  
Telephone: (755) 83448688  
Fax: (755) 83442996  
Site Listed with Federal Communications commission (FCC)  
Registration Number:744189  
For 3m Anechoic Chamber  
Site Listed with Industry Canada of Ottawa, Canada  
Registration Number: IC: 5205A  
For 3m Anechoic Chamber

### 1.2 Applicant Details

Applicant: Yuhong Electronics (Shenzhen) Co., LTD  
Address: 407, Floor 4, Building D, Youth Pioneer Park, East Jianshe Road, Qinghua Community, Longhua Street, Longhua District, Shenzhen  
Telephone: 0755-86704703  
Fax: --

### 1.3 Description of EUT

Product: AIOJET  
Manufacturer: Yuhong Electronics (Shenzhen) Co., LTD  
Address: 407, Floor 4, Building D, Youth Pioneer Park, East Jianshe Road, Qinghua Community, Longhua Street, Longhua District, Shenzhen  
Trademark: SHO-U  
Model Number: AIOJet G1P  
Additional Model Number: N/A  
Hardware Version: V1.0  
Software Version: 2023.41.815.2016  
Serial No.: SPWi72206T5U00001  
Type of Modulation GFSK,  $\pi/4$ D-QPSK, 8DPSK for Bluetooth  
Frequency range 2402-2480MHz for Bluetooth  
Channel Spacing 1MHz for Bluetooth  
Frequency Selection By software  
Channel Number 79 channels for Bluetooth  
Antenna: Male IPEX connector with PCB antenna. The gain of the antennas is 2.0dBi (get from the antenna specification provided the applicant)

The report refers only to the sample tested and does not apply to the bulk.

This report is issued in confidence to the client and it will be strictly treated as such by the SHENZHEN TIMEWAY TESTING LABORATORIES. It may not be reproduced rather in its entirety or in part and it may not be used for advertising. The client to whom the report is issued may, however, show or send it . or a certified copy thereof prepared by the SHENZHEN TIMEWAY TESTING LABORATORIES. to his customer. Supplier or others persons directly concerned. SHENZHEN TIMEWAY TESTING LABORATORIES. will not, without the consent of the client enter into any discussion of correspondence with any third party concerning the contents of the report.

In the event of the improper use of the report. The SHENZHEN TIMEWAY TESTING LABORATORIES. reserves the rights to withdraw it and to adopt any other remedies which may be appropriate.





<b>2.0 Test Equipment</b>					
Instrument Type	Manufacturer	Model	Serial No.	Date of Cal.	Due Date
ESPI Test Receiver	R&S	ESPI 3	100379	2021-06-18	2022-06-17
Impuls-Begrenzer	R&S	ESH3-Z2	100281	2021-06-18	2022-06-17
Loop Antenna	EMCO	6507	00078608	2021-06-18	2024-06-17
Spectrum	R&S	FSIQ26	100292	2021-06-18	2022-06-17
Horn Antenna	A-INFO	LB-180400-KF	J211060660	2021-07-02	2024-07-01
Horn Antenna	R&S	BBHA 9120D	9120D-631	2021-07-02	2024-07-01
Power meter	Anritsu	ML2487A	6K00003613	2021-06-18	2022-06-17
Power sensor	Anritsu	MA2491A	32263	2021-06-18	2022-06-17
Bilog Antenna	Schwarebeck	VULB9163	9163/340	2021-07-02	2024-07-01
9*6*6 Anechoic	--	--	N/A	2021-07-02	2022-07-01
EMI Test Receiver	RS	ESVB	826156/011	2021-06-18	2022-06-17
EMI Test Receiver	RS	ESH3	860904/006	2021-06-18	2022-06-17
Spectrum	HP/Agilent	ESA-L1500A	US37451154	2021-06-18	2022-06-17
Spectrum	HP/Agilent	E4407B	MY50441392	2021-06-18	2022-06-17
Spectrum	RS	FSP	1164.4391.38	2022-01-15	2023-01-14
RF Cable	Zhengdi	ZT26-NJ-NJ-8 M/FA	--	2021-06-18	2022-06-17
RF Cable	Zhengdi	7m	--	2021-06-18	2022-06-17
RF Switch	EM	EMSW18	060391	2021-06-18	2022-06-17
Pre-Amplifier	Schwarebeck	BBV9743	#218	2021-06-18	2022-06-17
Pre-Amplifier	HP/Agilent	8449B	3008A00160	2021-06-18	2022-06-17
LISN	SCHAFFNER	NNB42	00012	2022-01-05	2023-01-04

## 2.2 Automation Test Software

### For Conducted Emission Test

Name	Version
EZ-EMC	Ver.EMC-CON 3A1.1

### For Radiated Emissions

Name	Version
EMI Test Software BL410-EV18.91	V18.905
EMI Test Software BL410-EV18.806 High Frequency	V18.06

The report refers only to the sample tested and does not apply to the bulk.

This report is issued in confidence to the client and it will be strictly treated as such by the SHENZHEN TIMEWAY TESTING LABORATORIES. It may not be reproduced rather in its entirety or in part and it may not be used for advertising. The client to whom the report is issued may, however, show or send it, or a certified copy thereof prepared by the SHENZHEN TIMEWAY TESTING LABORATORIES, to his customer, Supplier or others persons directly concerned. SHENZHEN TIMEWAY TESTING LABORATORIES, will not, without the consent of the client enter into any discussion of correspondence with any third party concerning the contents of the report.

In the event of the improper use of the report, The SHENZHEN TIMEWAY TESTING LABORATORIES, reserves the rights to withdraw it and to adopt any other remedies which may be appropriate.



### 3.0 Technical Details

#### 3.1 Summary of test results

The EUT has been tested according to the following specifications:			
Requirement	CFR 47 Section	Result	Notes
Antenna Requirement	15.203, 15.247(b)(4)	Pass	Complies
Maximum Peak Out Power	15.247 (b)(1), (4)	Pass	Complies
Carrier Frequency Separation	15.247(a)(1)	Pass	Complies
20dB Channel Bandwidth	15.247 (a)(1)	Pass	Complies
Number of Hopping Channels	15.247(a)(iii), 15.247(b)(1)	Pass	Complies
Time of Occupancy (Dwell Time)	15.247(a)(iii)	Pass	Complies
Spurious Emission, Band Edge, and Restricted bands	15.247(d),15.205(a), 15.209 (a),15.109	Pass	Complies
Conducted Emissions	15.207	Pass	Complies
RF Exposure	15.247(i), 1.1307(b)(1)	Pass	Complies

**Note: the multi-functional base and simple base were tested and only the worst case was reported. The multi-functional base was the worst case.**

#### 3.2 Test Standards

**FCC Part 15 Subpart & Subpart C, Paragraph 15.247**

#### 4.0 EUT Modification

**No modification by SHENZHEN TIMEWAY TESTING LABORATORIES.**

The report refers only to the sample tested and does not apply to the bulk.  
This report is issued in confidence to the client and it will be strictly treated as such by the SHENZHEN TIMEWAY TESTING LABORATORIES. It may not be reproduced rather in its entirety or in part and it may not be used for advertising. The client to whom the report is issued may, however, show or send it . or a certified copy there of prepared by the SHENZHEN TIMEWAY TESTING LABORATORIES. to his customer. Supplier or others persons directly concerned. SHENZHEN TIMEWAY TESTING LABORATORIES. will not, without the consent of the client enter into any discussion of correspondence with any third party concerning the contents of the report.  
In the event of the improper use of the report. The SHENZHEN TIMEWAY TESTING LABORATORIES. reserves the rights to withdraw it and to adopt any other remedies which may be appropriate.



## 5. Power Line Conducted Emission Test

### 5.1 Schematics of the test

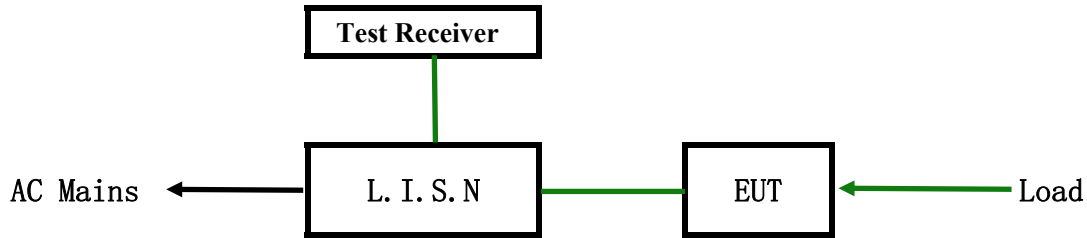

EUT: Equipment Under Test

### 5.2 Test Method and test Procedure

The EUT was tested according to ANSI C63.10-2013. The Frequency spectrum From 0.15MHz to 30MHz was investigated. The LISN used was 50ohm/50uH as specified by section 5.1 of ANSI C63.10-2013.

Test Voltage: 120V~ 60Hz

Block diagram of Test setup

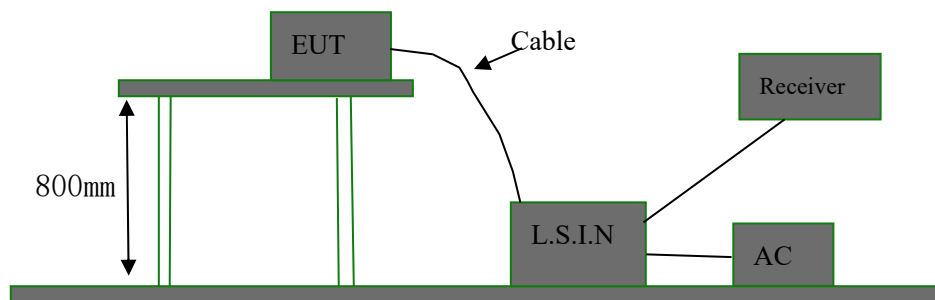

### 5.3 Configuration of the EUT

The EUT was configured according to ANSI C63.10-2013. All interface ports were connected to the appropriate peripherals. All peripherals and cables are listed below.

The report refers only to the sample tested and does not apply to the bulk.

This report is issued in confidence to the client and it will be strictly treated as such by the SHENZHEN TIMEWAY TESTING LABORATORIES. It may not be reproduced rather in its entirety or in part and it may not be used for advertising. The client to whom the report is issued may, however, show or send it, or a certified copy thereof prepared by the SHENZHEN TIMEWAY TESTING LABORATORIES, to his customer. Supplier or others persons directly concerned. SHENZHEN TIMEWAY TESTING LABORATORIES, will not, without the consent of the client enter into any discussion of correspondence with any third party concerning the contents of the report.

In the event of the improper use of the report. The SHENZHEN TIMEWAY TESTING LABORATORIES, reserves the rights to withdraw it and to adopt any other remedies which may be appropriate.





A. EUT

Device	Manufacturer	Model	FCC ID
AIOJET	Yuhong Electronics (Shenzhen) Co., LTD	AIOJet G1P	2A3BL-AIOJETG1P

B. Internal Device

Device	Manufacturer	Model	Rating
N/A			

C. Peripherals

Device	Manufacturer	Model	Rating
Mouse	Dell	B100	--

5.4 EUT Operating Condition

Operating condition is according to ANSI C63.10-2013.

A Setup the EUT and simulators as shown on follow

B Enable AF signal and confirm EUT active to normal condition

5.5 Power line conducted Emission Limit according to Paragraph 15.207

Frequency (MHz)	Limits (dB $\mu$ V)	
	Quasi-peak Level	Average Level
0.15 ~ 0.50	66.0~56.0*	56.0~46.0*
0.50 ~ 5.00	56.0	46.0
5.00 ~ 30.00	60.0	0.0

- Notes: 1. \*Decreasing linearly with logarithm of frequency.  
 2. The tighter limit shall apply at the transition frequencies

5.6 Test Results

The frequency spectrum from 0.15MHz to 30MHz was investigated. All reading are quasi-peak values with a resolution bandwidth of 9kHz.

The report refers only to the sample tested and does not apply to the bulk.

This report is issued in confidence to the client and it will be strictly treated as such by the SHENZHEN TIMEWAY TESTING LABORATORIES. It may not be reproduced rather in its entirety or in part and it may not be used for adverting. The client to whom the report is issued may, however, show or send it or a certified copy thereof prepared by the SHENZHEN TIMEWAY TESTING LABORATORIES to his customer. Supplier or others persons directly concerned. SHENZHEN TIMEWAY TESTING LABORATORIES will not, without the consent of the client enter into any discussion of correspondence with any third party concerning the contents of the report.

In the event of the improper use of the report. The SHENZHEN TIMEWAY TESTING LABORATORIES reserves the rights to withdraw it and to adopt any other remedies which may be appropriate.



**A: Conducted Emission on Live Terminal (150kHz to 30MHz)**

**EUT Operating Environment**

Temperature: 26°C Humidity: 65%RH Atmospheric Pressure: 101 kPa

**EUT set Condition: Keep Bluetooth Transmitting**

**Results: Pass**

Please refer to following diagram for individual

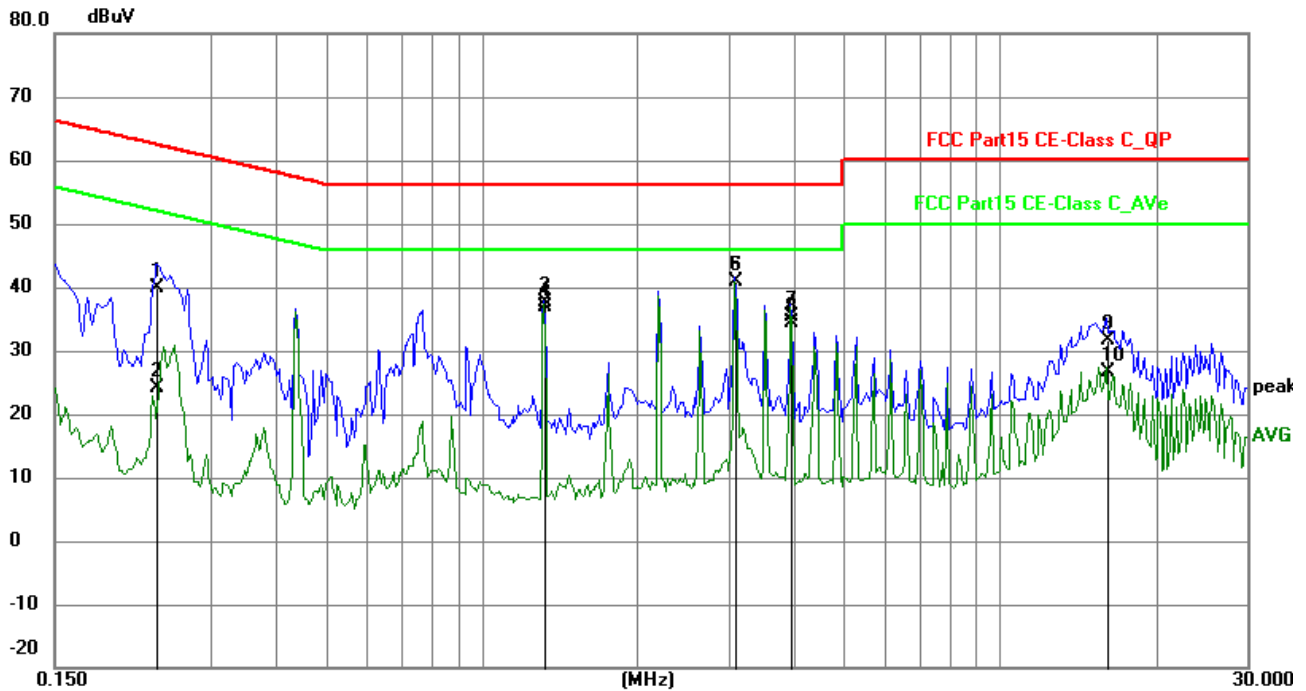

No.	Frequency (MHz)	Reading (dBuV)	Factor (dB)	Level (dBuV)	Limit (dBuV)	Margin (dB)	Detector	P/F
1	0.2358	30.25	9.75	40.00	62.24	-22.24	QP	P
2	0.2358	14.33	9.75	24.08	52.24	-28.16	AVG	P
3	1.3200	27.87	9.79	37.66	56.00	-18.34	QP	P
4	1.3200	27.07	9.79	36.86	46.00	-9.14	AVG	P
5	3.0780	31.11	9.85	40.96	56.00	-15.04	QP	P
6	3.0780	31.13	9.85	40.98	46.00	-5.02	AVG	P
7	3.9594	25.60	9.88	35.48	56.00	-20.52	QP	P
8	3.9594	24.54	9.88	34.42	46.00	-11.58	AVG	P
9	16.0806	21.12	10.44	31.56	60.00	-28.44	QP	P
10	16.0806	16.30	10.44	26.74	50.00	-23.26	AVG	P

The report refers only to the sample tested and does not apply to the bulk.  
 This report is issued in confidence to the client and it will be strictly treated as such by the SHENZHEN TIMEWAY TESTING LABORATORIES. It may not be reproduced rather in its entirety or in part and it may not be used for advertising. The client to whom the report is issued may, however, show or send it, or a certified copy thereof prepared by the SHENZHEN TIMEWAY TESTING LABORATORIES, to his customer. Supplier or others persons directly concerned. SHENZHEN TIMEWAY TESTING LABORATORIES, will not, without the consent of the client enter into any discussion of correspondence with any third party concerning the contents of the report.  
 In the event of the improper use of the report. The SHENZHEN TIMEWAY TESTING LABORATORIES, reserves the rights to withdraw it and to adopt any other remedies which may be appropriate.



**B: Conducted Emission on Neutral Terminal (150kHz to 30MHz)**

**EUT Operating Environment**

Temperature: 26°C Humidity: 65%RH Atmospheric Pressure: 101 kPa

**EUT set Condition: Keep Bluetooth Transmitting**

**Results: Pass**

Please refer to following diagram for individual

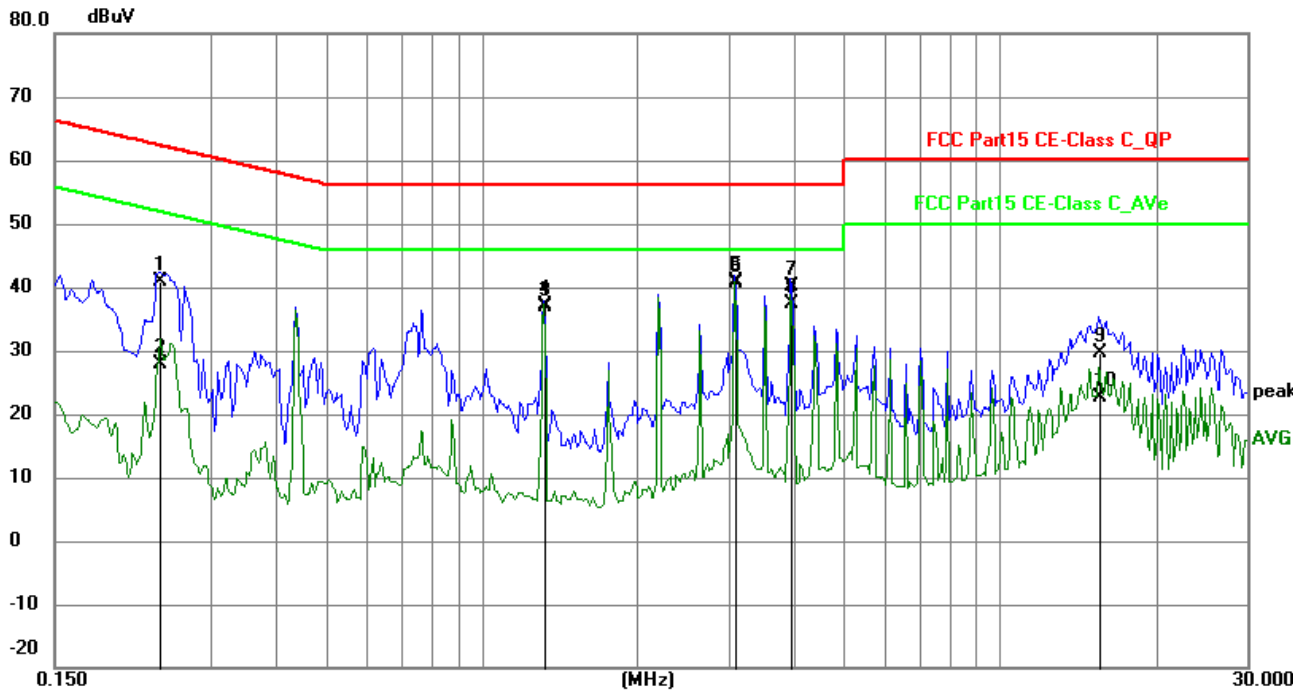

No.	Frequency (MHz)	Reading (dBuV)	Factor (dB)	Level (dBuV)	Limit (dBuV)	Margin (dB)	Detector	P/F
1	0.2397	31.16	9.75	40.91	62.11	-21.20	QP	P
2	0.2397	18.11	9.75	27.86	52.11	-24.25	AVG	P
3	1.3200	27.06	9.79	36.85	56.00	-19.15	QP	P
4	1.3200	27.31	9.79	37.10	46.00	-8.90	AVG	P
5	3.0780	31.13	9.85	40.98	56.00	-15.02	QP	P
6	3.0780	30.88	9.85	40.73	46.00	-5.27	AVG	P
7	3.9594	30.13	9.88	40.01	56.00	-15.99	QP	P
8	3.9594	27.60	9.88	37.48	46.00	-8.52	AVG	P
9	15.4761	19.13	10.41	29.54	60.00	-30.46	QP	P
10	15.4761	12.34	10.41	22.75	50.00	-27.25	AVG	P

The report refers only to the sample tested and does not apply to the bulk.  
 This report is issued in confidence to the client and it will be strictly treated as such by the SHENZHEN TIMEWAY TESTING LABORATORIES. It may not be reproduced rather in its entirety or in part and it may not be used for advertising. The client to whom the report is issued may, however, show or send it . or a certified copy there of prepared by the SHENZHEN TIMEWAY TESTING LABORATORIES. to his customer. Supplier or others persons directly concerned. SHENZHEN TIMEWAY TESTING LABORATORIES. will not, without the consent of the client enter into any discussion of correspondence with any third party concerning the contents of the report.  
 In the event of the improper use of the report. The SHENZHEN TIMEWAY TESTING LABORATORIES. reserves the rights to withdraw it and to adopt any other remedies which may be appropriate.



## 6 Radiated Emission Test

### 6.1 Test Method and test Procedure:

- (1) The EUT was tested according to ANSI C63.10-2013. The radiated test was performed at Timeway EMC Laboratory. This site is on file with the FCC laboratory division, Registration No. 744189
- (2) The EUT, peripherals were put on the turntable which table size is 1m x 1.5 m, table high 0.8 m. All set up is according to ANSI C63.10-2013.
- (3) The frequency spectrum from 30 MHz to 25GHz was investigated. All readings from 30 MHz to 1 GHz are quasi-peak values with a resolution bandwidth of 120 kHz. For measurement above 1GHz, peak values with RBW=VBW=1MHz and PK detector. AV value with RBW=1MHz, VBW=10Hz and PK detector. Measurements were made at 3 meters.
- (4) The antenna high is varied from 1 m to 4 m high to find the maximum emission for each frequency.
- (5) Maximizing procedure was performed on the six (6) highest emissions to ensure EUT compliance is with all installation combinations. All data was recorded in the peak detection mode. Quasi-peak readings was performed only when an emission was found to be marginal (within -4 dB of specification limit), and are distinguished with a "QP" in the data table.
- (6) The antenna polarization : Vertical polarization and Horizontal polarization.

### Block diagram of Test setup

For radiated emissions from 9kHz to 30MHz

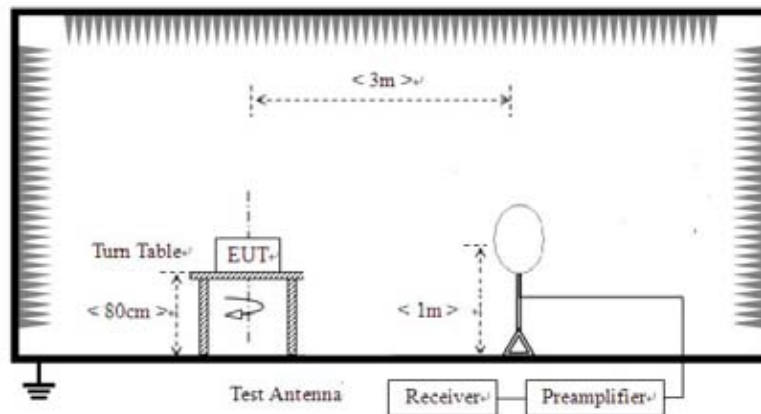

The report refers only to the sample tested and does not apply to the bulk.

This report is issued in confidence to the client and it will be strictly treated as such by the SHENZHEN TIMEWAY TESTING LABORATORIES. It may not be reproduced rather in its entirety or in part and it may not be used for advertising. The client to whom the report is issued may, however, show or send it, or a certified copy thereof prepared by the SHENZHEN TIMEWAY TESTING LABORATORIES, to his customer. Supplier or others persons directly concerned. SHENZHEN TIMEWAY TESTING LABORATORIES, will not, without the consent of the client enter into any discussion of correspondence with any third party concerning the contents of the report.

In the event of the improper use of the report. The SHENZHEN TIMEWAY TESTING LABORATORIES, reserves the rights to withdraw it and to adopt any other remedies which may be appropriate.



For radiated emissions from 30MHz to 1GHz

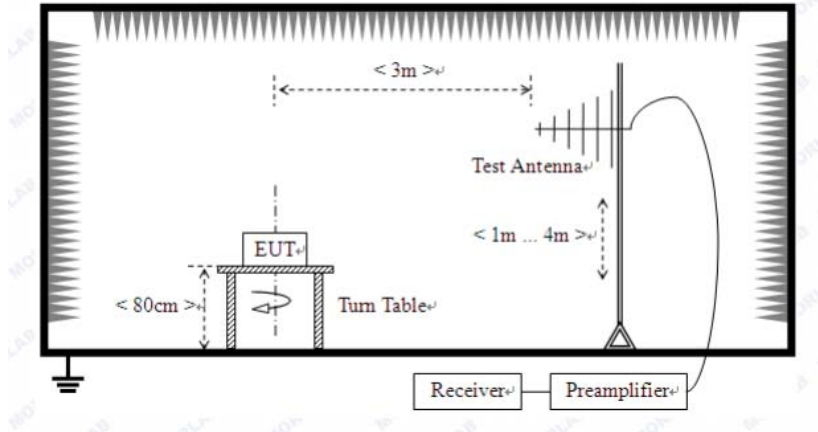

For radiated emissions above 1GHz

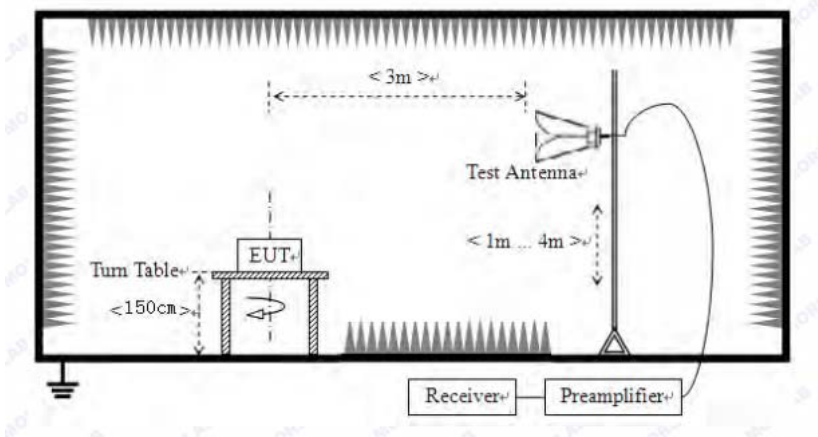

## 6.2 Configuration of The EUT

Same as section 5.3 of this report

## 6.3 EUT Operating Condition

Same as section 5.4 of this report.

## 6.4 Radiated Emission Limit

All emission from a digital device, including any network of conductors and apparatus connected thereto, shall not exceed the level of field strength specified below:

The report refers only to the sample tested and does not apply to the bulk.

This report is issued in confidence to the client and it will be strictly treated as such by the SHENZHEN TIMEWAY TESTING LABORATORIES. It may not be reproduced rather in its entirety or in part and it may not be used for advertising. The client to whom the report is issued may, however, show or send it, or a certified copy thereof prepared by the SHENZHEN TIMEWAY TESTING LABORATORIES, to his customer. Supplier or others persons directly concerned. SHENZHEN TIMEWAY TESTING LABORATORIES, will not, without the consent of the client enter into any discussion of correspondence with any third party concerning the contents of the report.

In the event of the improper use of the report. The SHENZHEN TIMEWAY TESTING LABORATORIES, reserves the rights to withdraw it and to adopt any other remedies which may be appropriate.



**Frequencies in restricted band are complied to limit on Paragraph 15.209**

Frequency Range (MHz)	Distance (m)	Field strength (dB $\mu$ V/m)
0.009-0.049	3	$20\log(2400/F(\text{kHz})) + 40\log(300/3)$
0.490-1.705	3	$20\log(24000/F(\text{kHz})) + 40\log(30/3)$
1.705-30	3	69.5
30-88	3	40.0
88-216	3	43.5
216-960	3	46.0
Above 960	3	54.0

- Note:
1. RF Voltage (dBuV) = 20 log RF Voltage (uV)
  2. In the Above Table, the higher limit applies at the band edges.
  3. Distance refers to the distance in meters between the measuring instrument antenna and the EUT
  4. GFSK was the worst case because it has highest output power

The report refers only to the sample tested and does not apply to the bulk.  
This report is issued in confidence to the client and it will be strictly treated as such by the SHENZHEN TIMEWAY TESTING LABORATORIES. It may not be reproduced rather in its entirety or in part and it may not be used for advertising. The client to whom the report is issued may, however, show or send it . or a certified copy there of prepared by the SHENZHEN TIMEWAY TESTING LABORATORIES. to his customer. Supplier or others persons directly concerned. SHENZHEN TIMEWAY TESTING LABORATORIES. will not, without the consent of the client enter into any discussion of correspondence with any third party concerning the contents of the report.  
In the event of the improper use of the report. The SHENZHEN TIMEWAY TESTING LABORATORIES. reserves the rights to withdraw it and to adopt any other remedies which may be appropriate.



**Test result**

**General Radiated Emission Data and Harmonics Radiated Emission Data**

**Radiated Emission In Horizontal/Vertical (30MHz----1000MHz)**

EUT set Condition:       Keep Bluetooth Transmitting

**Results:**               **Pass**

The report refers only to the sample tested and does not apply to the bulk.

This report is issued in confidence to the client and it will be strictly treated as such by the SHENZHEN TIMEWAY TESTING LABORATORIES. It may not be reproduced rather in its entirety or in part and it may not be used for adverting. The client to whom the report is issued may, however, show or send it . or a certified copy there of prepared by the SHENZHEN TIMEWAY TESTING LABORATORIES. to his customer. Supplier or others persons directly concerned. SHENZHEN TIMEWAY TESTING LABORATORIES. will not, without the consent of the client enter into any discussion of correspondence with any third party concerning the contents of the report.

In the event of the improper use of the report. The SHENZHEN TIMEWAY TESTING LABORATORIES. reserves the rights to withdraw it and to adopt any other remedies which may be appropriate.



Test Figure:

H

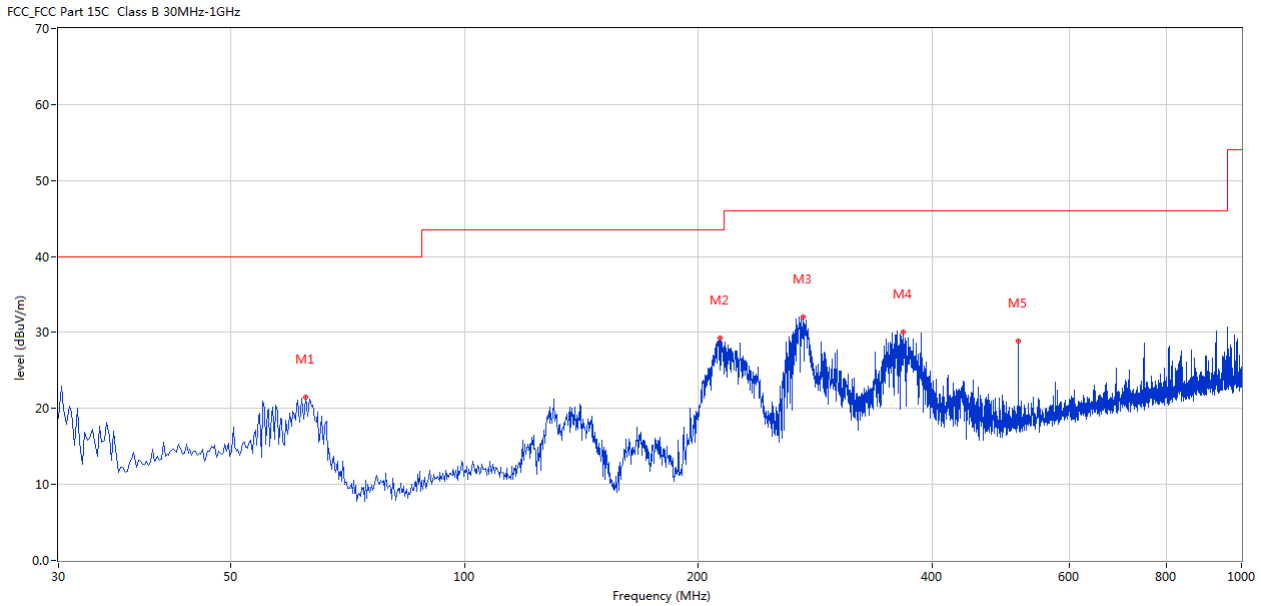

No.	Frequency (MHz)	Results (dBuV/m)	Factor (dB)	Limit (dBuV/m)	Over Limit (dB)	Detector	Table (o)	Height (cm)	ANT	Verdict
1	62.487	21.48	-13.28	40.0	-18.52	Peak	29.00	100	Horizontal	Pass
2	213.042	29.23	-13.66	43.5	-14.27	Peak	338.00	100	Horizontal	Pass
3	272.924	32.08	-11.66	46.0	-13.92	Peak	319.00	100	Horizontal	Pass
4	366.506	30.01	-9.50	46.0	-15.99	Peak	334.00	100	Horizontal	Pass
5	515.849	28.92	-6.80	46.0	-17.08	Peak	120.00	100	Horizontal	Pass

The report refers only to the sample tested and does not apply to the bulk.

This report is issued in confidence to the client and it will be strictly treated as such by the SHENZHEN TIMEWAY TESTING LABORATORIES. It may not be reproduced rather in its entirety or in part and it may not be used for advertising. The client to whom the report is issued may, however, show or send it or a certified copy thereof prepared by the SHENZHEN TIMEWAY TESTING LABORATORIES to his customer. Supplier or others persons directly concerned. SHENZHEN TIMEWAY TESTING LABORATORIES will not, without the consent of the client enter into any discussion of correspondence with any third party concerning the contents of the report.

In the event of the improper use of the report. The SHENZHEN TIMEWAY TESTING LABORATORIES reserves the rights to withdraw it and to adopt any other remedies which may be appropriate.





Test Figure:

V

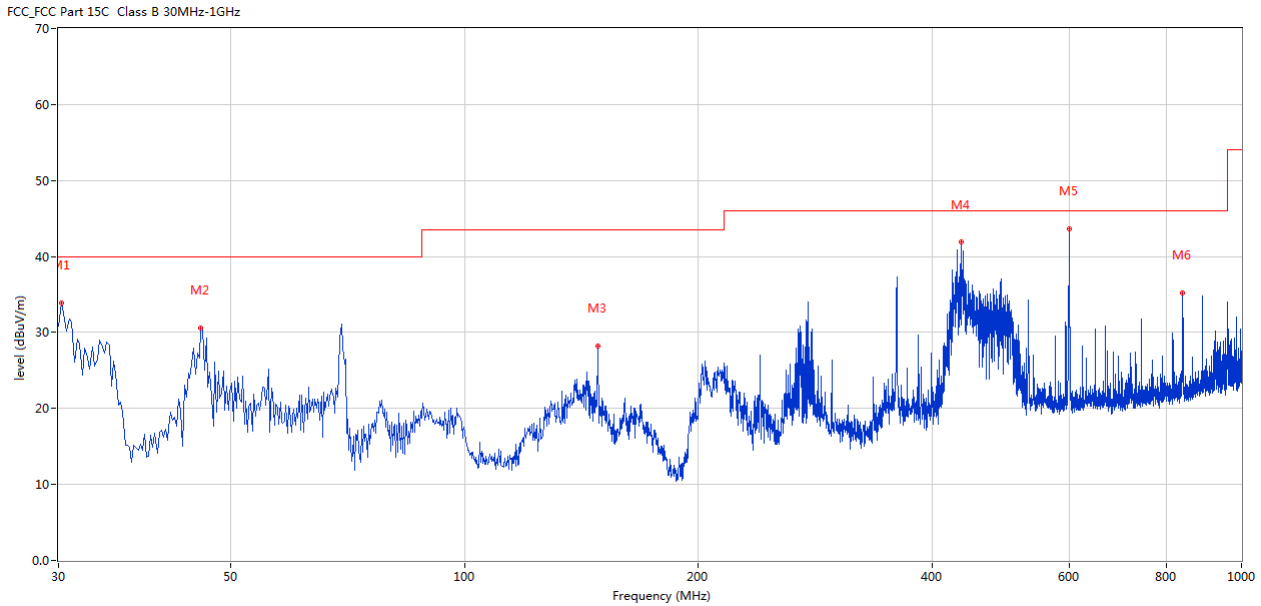

No.	Frequency (MHz)	Results (dBuV/m)	Factor (dB)	Limit (dBuV/m)	Over Limit (dB)	Detector	Table (o)	Height (cm)	ANT	Verdict
1	30.000	30.81	-14.19	40.0	-9.19	Peak	84.00	100	Vertical	Pass
2	45.759	30.62	-11.40	40.0	-9.38	Peak	202.00	100	Vertical	Pass
3	148.553	28.22	-17.15	43.5	-15.28	Peak	174.00	100	Vertical	Pass
4	435.601	41.86	-8.01	46.0	-4.14	Peak	168.00	100	Vertical	Pass
5	599.975	43.63	-4.95	46.0	-2.37	Peak	202.00	100	Vertical	Pass
6	839.990	35.23	-2.61	46.0	-10.77	Peak	149.00	100	Vertical	Pass

The report refers only to the sample tested and does not apply to the bulk.

This report is issued in confidence to the client and it will be strictly treated as such by the SHENZHEN TIMEWAY TESTING LABORATORIES. It may not be reproduced rather in its entirety or in part and it may not be used for advertising. The client to whom the report is issued may, however, show or send it or a certified copy thereof prepared by the SHENZHEN TIMEWAY TESTING LABORATORIES to his customer. Supplier or others persons directly concerned. SHENZHEN TIMEWAY TESTING LABORATORIES will not, without the consent of the client enter into any discussion of correspondence with any third party concerning the contents of the report.

In the event of the improper use of the report. The SHENZHEN TIMEWAY TESTING LABORATORIES reserves the rights to withdraw it and to adopt any other remedies which may be appropriate.



**Operation Mode: Transmitting under Low Channel (2402MHz)**

Frequency (MHz)	Level@3m (dB $\mu$ V/m)	Antenna Polarity	Limit@3m (dB $\mu$ V/m)
4804	47.16	H	74(Peak)/ 54(AV)
4804	49.63	V	74(Peak)/ 54(AV)
7206	--	H/V	74(Peak)/ 54(AV)
9608	--	H/V	74(Peak)/ 54(AV)
12010	--	H/V	74(Peak)/ 54(AV)
14412	--	H/V	74(Peak)/ 54(AV)
16814	--	H/V	74(Peak)/ 54(AV)
19216	--	H/V	74(Peak)/ 54(AV)
21618	--	H/V	74(Peak)/ 54(AV)
24020	--	H/V	74(Peak)/ 54(AV)

**Operation Mode: Transmitting g under Middle Channel (2441MHz)**

Frequency (MHz)	Level@3m (dB $\mu$ V/m)	Antenna Polarity	Limit@3m (dB $\mu$ V/m)
4882	46.20	H	74(Peak)/ 54(AV)
4882	48.59	V	74(Peak)/ 54(AV)
7323	--	H/V	74(Peak)/ 54(AV)
9764	--	H/V	74(Peak)/ 54(AV)
12205	--	H/V	74(Peak)/ 54(AV)
14646	--	H/V	74(Peak)/ 54(AV)
17087	--	H/V	74(Peak)/ 54(AV)
19528	--	H/V	74(Peak)/ 54(AV)
21969	--	H/V	74(Peak)/ 54(AV)
24410	--	H/V	74(Peak)/ 54(AV)

The report refers only to the sample tested and does not apply to the bulk.

This report is issued in confidence to the client and it will be strictly treated as such by the SHENZHEN TIMEWAY TESTING LABORATORIES. It may not be reproduced rather in its entirety or in part and it may not be used for advertising. The client to whom the report is issued may, however, show or send it . or a certified copy there of prepared by the SHENZHEN TIMEWAY TESTING LABORATORIES. to his customer. Supplier or others persons directly concerned. SHENZHEN TIMEWAY TESTING LABORATORIES. will not, without the consent of the client enter into any discussion of correspondence with any third party concerning the contents of the report.

In the event of the improper use of the report. The SHENZHEN TIMEWAY TESTING LABORATORIES. reserves the rights to withdraw it and to adopt any other remedies which may be appropriate.



**Operation Mode: Transmitting under High Channel (2480MHz)**

Frequency (MHz)	Level@3m (dB $\mu$ V/m)	Antenna Polarity	Limit@3m (dB $\mu$ V/m)
4960	45.81	H	74(Peak)/ 54(AV)
4960	48.02	V	74(Peak)/ 54(AV)
7440	--	H/V	74(Peak)/ 54(AV)
9920	--	H/V	74(Peak)/ 54(AV)
12400	--	H/V	74(Peak)/ 54(AV)
14880	--	H/V	74(Peak)/ 54(AV)
17360	--	H/V	74(Peak)/ 54(AV)
19840	--	H/V	74(Peak)/ 54(AV)
22320	--	H/V	74(Peak)/ 54(AV)
24800	--	H/V	74(Peak)/ 54(AV)

- Note: 1. Level = Reading + AF + Cable - Preamp  
2. For the radiated emissions above 18G and Below 30MHz, it is the floor noise.  
3. The measured PK value less than the AV limit, no necessary to take down the AV measurement result.  
4. Remark “---” means that the emissions level is too low to be measured

The report refers only to the sample tested and does not apply to the bulk.  
This report is issued in confidence to the client and it will be strictly treated as such by the SHENZHEN TIMEWAY TESTING LABORATORIES. It may not be reproduced rather in its entirety or in part and it may not be used for advertising. The client to whom the report is issued may, however, show or send it or a certified copy thereof prepared by the SHENZHEN TIMEWAY TESTING LABORATORIES to his customer. Supplier or others persons directly concerned. SHENZHEN TIMEWAY TESTING LABORATORIES will not, without the consent of the client enter into any discussion of correspondence with any third party concerning the contents of the report.  
In the event of the improper use of the report. The SHENZHEN TIMEWAY TESTING LABORATORIES reserves the rights to withdraw it and to adopt any other remedies which may be appropriate.



## 7.0 20dB Bandwidth Measurement

### 7.1 Regulation

Intentional radiators operating under the alternative provisions to the general emission limits, as contained in §§ 15.217 through 15.257 and in Subpart E of this part, must be designed to ensure that the 20 dB bandwidth of the emission, or whatever bandwidth may otherwise be specified in the specific rule section under which the equipment operates, is contained within the frequency band designated in the rule section under which the equipment is operated.

### 7.2 Limits of 20dB Bandwidth Measurement

N/A

### 7.3 Test Procedure.

1. Check the calibration of the measuring instrument (spectrum analyzer) using either an internal calibrator or a known signal from an external generator.
2. Set the spectrum analyzer as follows: Span =2 or 2.4MHz, RBW =30 or 36 kHz, VBW=91or 110 kHz, Sweep = auto Detector function = peak, Trace = max hold
3. Measure the highest amplitude appearing on spectral display and record the level to calculate results. 6. Repeat above procedures until all frequencies measured were complete.

### 7.4 Test Result

#### Type of Modulation: GFSK

EUT	AIOJET		Model	AIOJet G1P
Mode	Keep Transmitting		Input Voltage	120V~
Temperature	24 deg. C,		Humidity	56% RH
Channel	Channel Frequency (MHz)	20 dB Bandwidth (MHz)	Minimum Limit (kHz)	Pass/ Fail
Low	2402	0.939	--	Pass
Middle	2441	0.957	--	Pass
High	2480	0.956	--	Pass

The report refers only to the sample tested and does not apply to the bulk.

This report is issued in confidence to the client and it will be strictly treated as such by the SHENZHEN TIMEWAY TESTING LABORATORIES. It may not be reproduced rather in its entirety or in part and it may not be used for advertising. The client to whom the report is issued may, however, show or send it . or a certified copy there of prepared by the SHENZHEN TIMEWAY TESTING LABORATORIES. to his customer. Supplier or others persons directly concerned. SHENZHEN TIMEWAY TESTING LABORATORIES. will not, without the consent of the client enter into any discussion of correspondence with any third party concerning the contents of the report.

In the event of the improper use of the report. The SHENZHEN TIMEWAY TESTING LABORATORIES. reserves the rights to withdraw it and to adopt any other remedies which may be appropriate.



Test Figure:

1. Condition: Low Channel

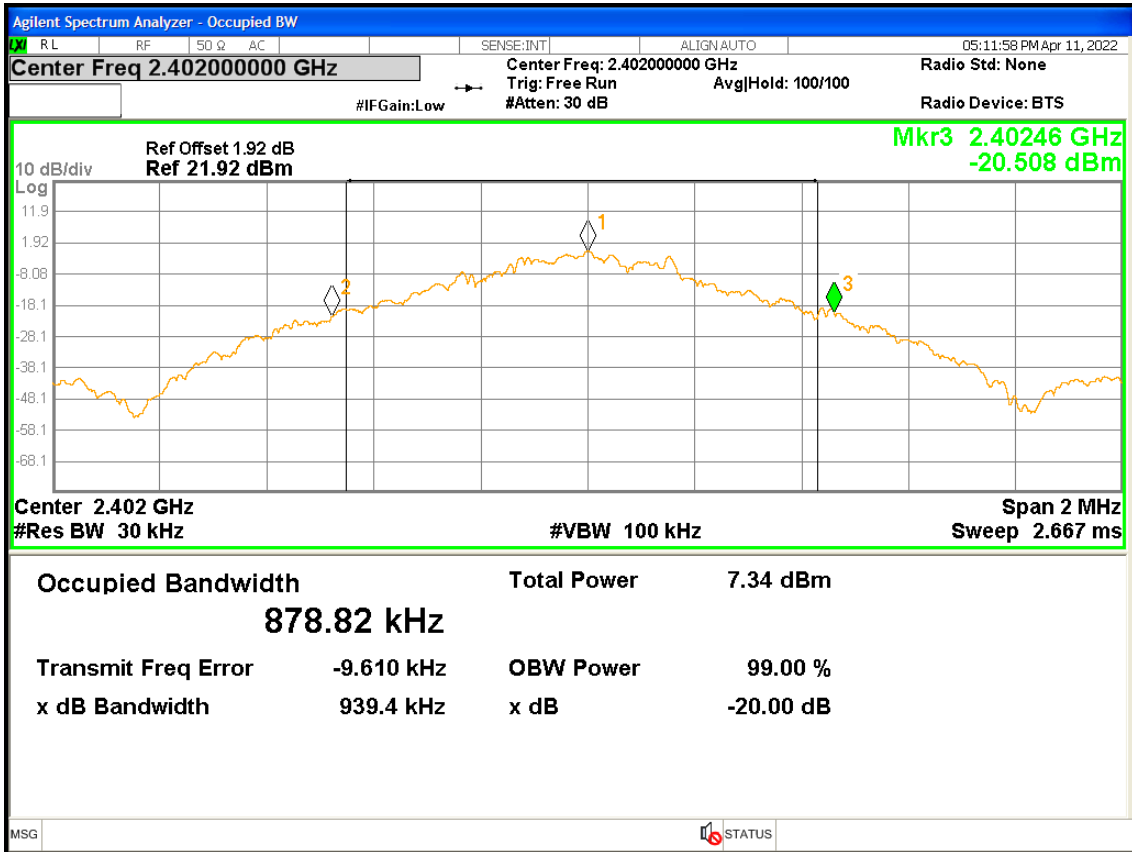

The report refers only to the sample tested and does not apply to the bulk.

This report is issued in confidence to the client and it will be strictly treated as such by the SHENZHEN TIMEWAY TESTING LABORATORIES. It may not be reproduced rather in its entirety or in part and it may not be used for advertising. The client to whom the report is issued may, however, show or send it . or a certified copy there of prepared by the SHENZHEN TIMEWAY TESTING LABORATORIES. to his customer. Supplier or others persons directly concerned. SHENZHEN TIMEWAY TESTING LABORATORIES. will not, without the consent of the client enter into any discussion of correspondence with any third party concerning the contents of the report.

In the event of the improper use of the report. The SHENZHEN TIMEWAY TESTING LABORATORIES. reserves the rights to withdraw it and to adopt any other remedies which may be appropriate.



2. Condition: Middle Channel

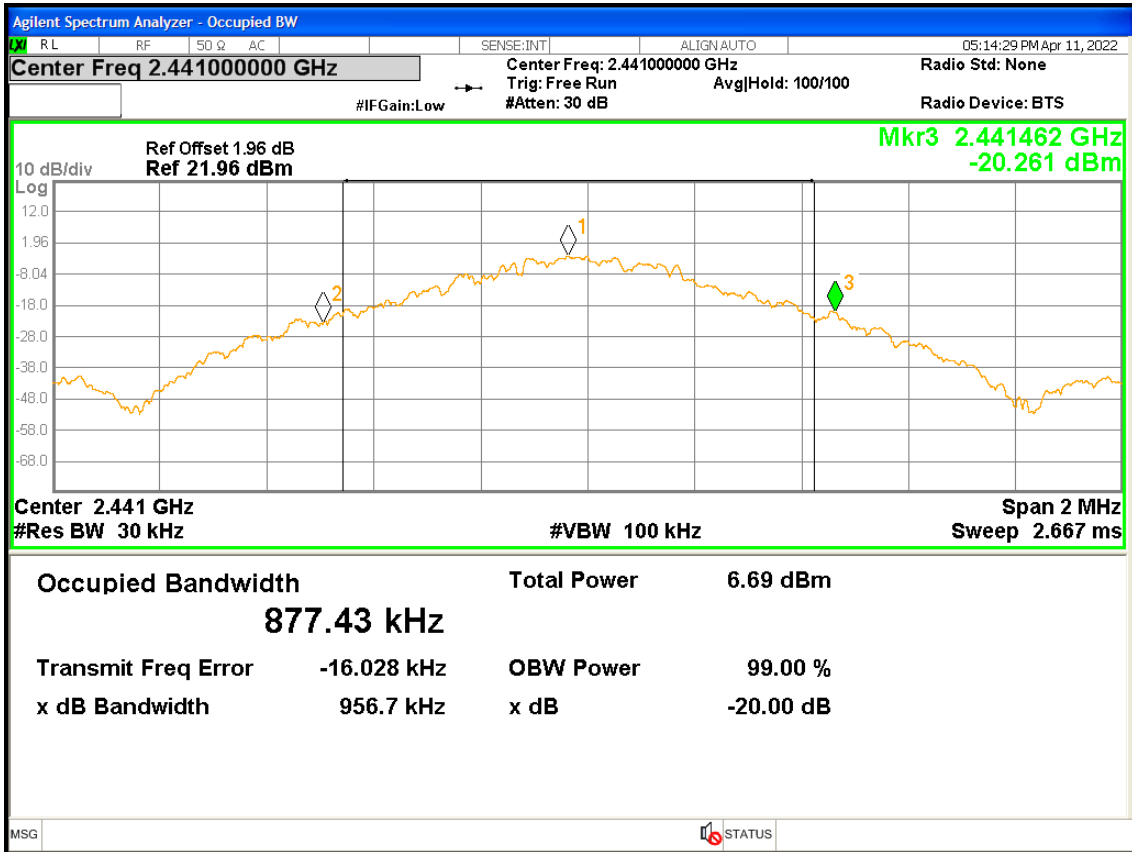

The report refers only to the sample tested and does not apply to the bulk. This report is issued in confidence to the client and it will be strictly treated as such by the SHENZHEN TIMEWAY TESTING LABORATORIES. It may not be reproduced rather in its entirety or in part and it may not be used for advertising. The client to whom the report is issued may, however, show or send it or a certified copy thereof prepared by the SHENZHEN TIMEWAY TESTING LABORATORIES to his customer. Supplier or others persons directly concerned. SHENZHEN TIMEWAY TESTING LABORATORIES will not, without the consent of the client enter into any discussion of correspondence with any third party concerning the contents of the report. In the event of the improper use of the report. The SHENZHEN TIMEWAY TESTING LABORATORIES reserves the rights to withdraw it and to adopt any other remedies which may be appropriate.



### 3. High Channel

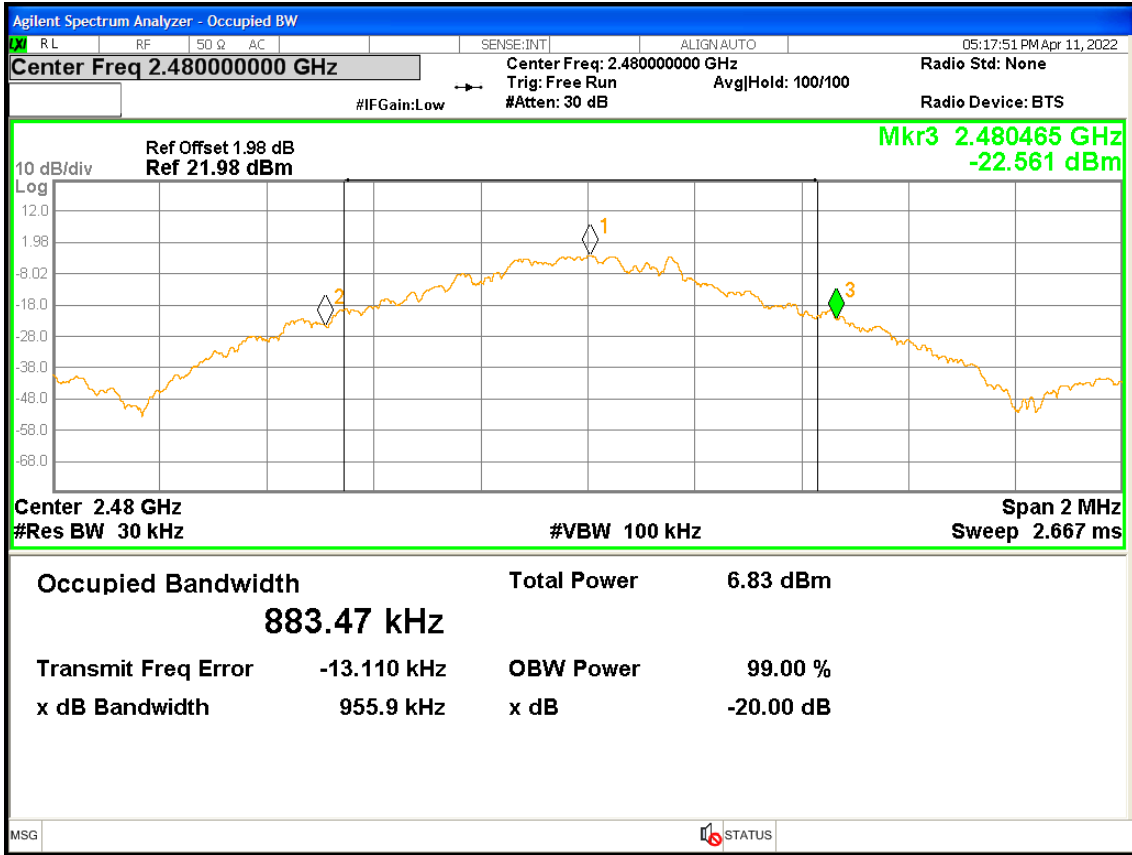

The report refers only to the sample tested and does not apply to the bulk.

This report is issued in confidence to the client and it will be strictly treated as such by the SHENZHEN TIMEWAY TESTING LABORATORIES. It may not be reproduced rather in its entirety or in part and it may not be used for advertising. The client to whom the report is issued may, however, show or send it or a certified copy thereof prepared by the SHENZHEN TIMEWAY TESTING LABORATORIES to his customer. Supplier or others persons directly concerned. SHENZHEN TIMEWAY TESTING LABORATORIES will not, without the consent of the client enter into any discussion of correspondence with any third party concerning the contents of the report.

In the event of the improper use of the report. The SHENZHEN TIMEWAY TESTING LABORATORIES reserves the rights to withdraw it and to adopt any other remedies which may be appropriate.



**Test Result**

**Type of Modulation:**  $\pi/4$ D-QPSK

EUT	AIOJET		Model	AIOJet G1P
Mode	Keep Transmitting		Input Voltage	120V~
Temperature	24 deg. C,		Humidity	56% RH
Channel	Channel Frequency (MHz)	20 dB Bandwidth (MHz)	Maximum Limit (kHz)	Pass/ Fail
Low	2402	1.414	--	Pass
Middle	2441	1.417	--	Pass
High	2480	1.413	--	Pass

The report refers only to the sample tested and does not apply to the bulk.  
 This report is issued in confidence to the client and it will be strictly treated as such by the SHENZHEN TIMEWAY TESTING LABORATORIES. It may not be reproduced rather in its entirety or in part and it may not be used for advertising. The client to whom the report is issued may, however, show or send it or a certified copy thereof prepared by the SHENZHEN TIMEWAY TESTING LABORATORIES to his customer. Supplier or others persons directly concerned. SHENZHEN TIMEWAY TESTING LABORATORIES will not, without the consent of the client enter into any discussion of correspondence with any third party concerning the contents of the report.  
 In the event of the improper use of the report. The SHENZHEN TIMEWAY TESTING LABORATORIES reserves the rights to withdraw it and to adopt any other remedies which may be appropriate.





Test Figure:

1. Condition: Low Channel

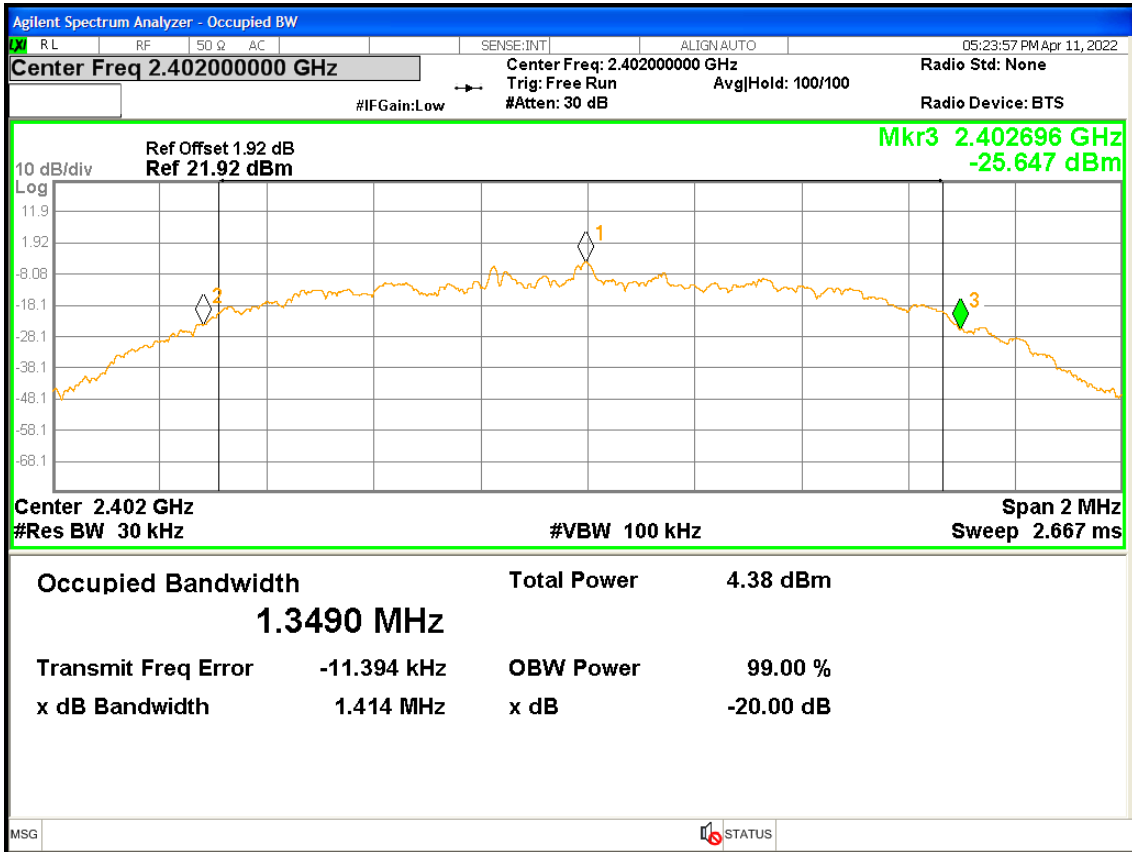

The report refers only to the sample tested and does not apply to the bulk.  
 This report is issued in confidence to the client and it will be strictly treated as such by the SHENZHEN TIMEWAY TESTING LABORATORIES. It may not be reproduced rather in its entirety or in part and it may not be used for advertising. The client to whom the report is issued may, however, show or send it . or a certified copy there of prepared by the SHENZHEN TIMEWAY TESTING LABORATORIES. to his customer. Supplier or others persons directly concerned. SHENZHEN TIMEWAY TESTING LABORATORIES. will not, without the consent of the client enter into any discussion of correspondence with any third party concerning the contents of the report.  
 In the event of the improper use of the report. The SHENZHEN TIMEWAY TESTING LABORATORIES. reserves the rights to withdraw it and to adopt any other remedies which may be appropriate.



2. Condition: Middle Channel

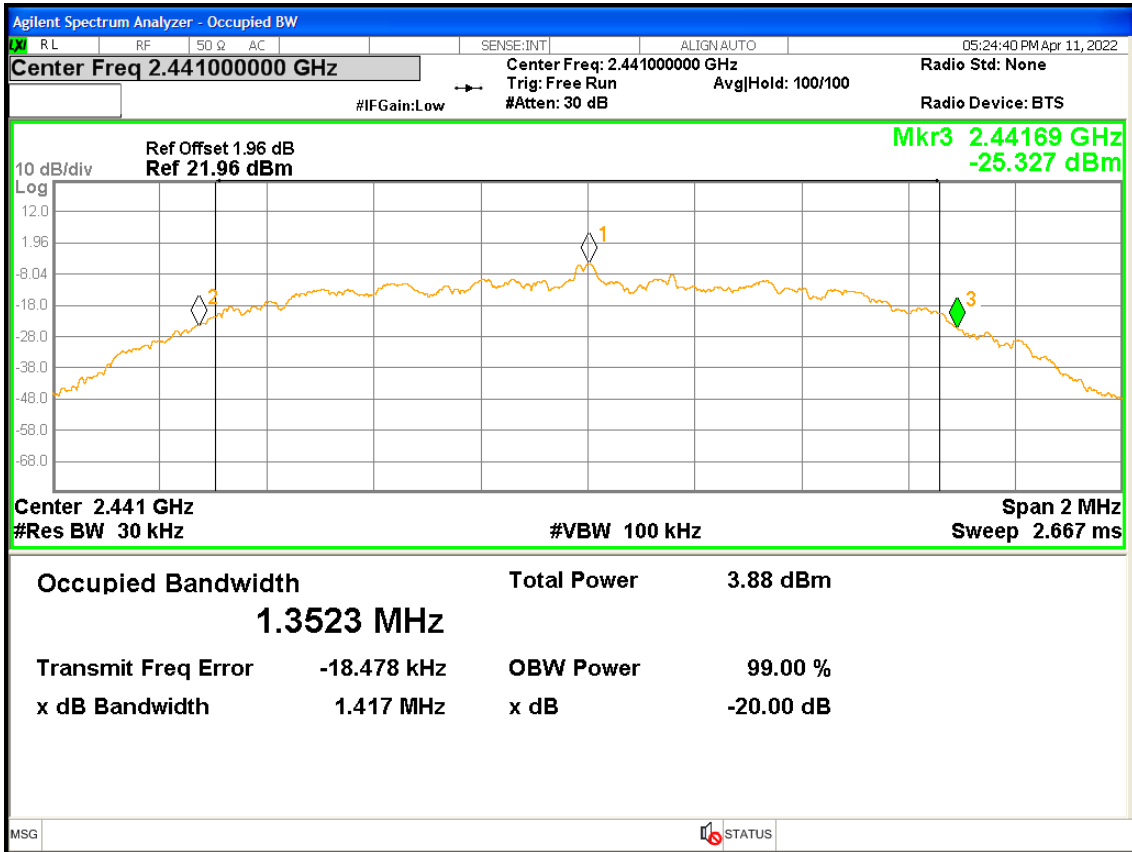

The report refers only to the sample tested and does not apply to the bulk. This report is issued in confidence to the client and it will be strictly treated as such by the SHENZHEN TIMEWAY TESTING LABORATORIES. It may not be reproduced rather in its entirety or in part and it may not be used for advertising. The client to whom the report is issued may, however, show or send it or a certified copy thereof prepared by the SHENZHEN TIMEWAY TESTING LABORATORIES to his customer. Supplier or others persons directly concerned. SHENZHEN TIMEWAY TESTING LABORATORIES will not, without the consent of the client enter into any discussion of correspondence with any third party concerning the contents of the report. In the event of the improper use of the report. The SHENZHEN TIMEWAY TESTING LABORATORIES reserves the rights to withdraw it and to adopt any other remedies which may be appropriate.



### 3. High Channel

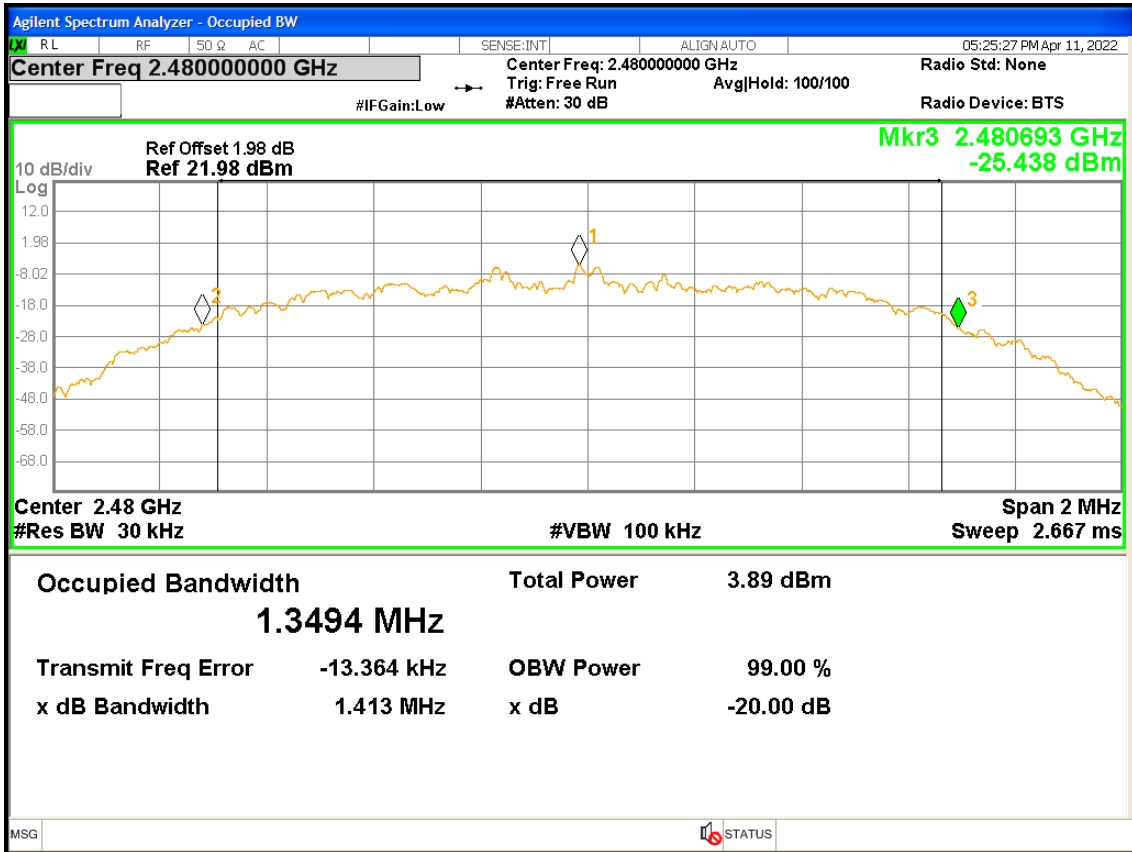

The report refers only to the sample tested and does not apply to the bulk.  
 This report is issued in confidence to the client and it will be strictly treated as such by the SHENZHEN TIMEWAY TESTING LABORATORIES. It may not be reproduced rather in its entirety or in part and it may not be used for adverting. The client to whom the report is issued may, however, show or send it . or a certified copy there of prepared by the SHENZHEN TIMEWAY TESTING LABORATORIES. to his customer. Supplier or others persons directly concerned. SHENZHEN TIMEWAY TESTING LABORATORIES. will not, without the consent of the client enter into any discussion of correspondence with any third party concerning the contents of the report.  
 In the event of the improper use of the report. The SHENZHEN TIMEWAY TESTING LABORATORIES. reserves the rights to withdraw it and to adopt any other remedies which may be appropriate.



## Test Result

**Type of Modulation: 8DPSK**

EUT	AIOJET		Model	AIOJet G1P
Mode	Keep Transmitting		Input Voltage	120V~
Temperature	24 deg. C,		Humidity	56% RH
Channel	Channel Frequency (MHz)	20 dB Bandwidth (MHz)	Maximum Limit (kHz)	Pass/ Fail
Low	2402	1.476	--	Pass
Middle	2441	1.484	--	Pass
High	2480	1.436	--	Pass

The report refers only to the sample tested and does not apply to the bulk.

This report is issued in confidence to the client and it will be strictly treated as such by the SHENZHEN TIMEWAY TESTING LABORATORIES. It may not be reproduced rather in its entirety or in part and it may not be used for advertising. The client to whom the report is issued may, however, show or send it or a certified copy thereof prepared by the SHENZHEN TIMEWAY TESTING LABORATORIES to his customer. Supplier or others persons directly concerned. SHENZHEN TIMEWAY TESTING LABORATORIES will not, without the consent of the client enter into any discussion of correspondence with any third party concerning the contents of the report.

In the event of the improper use of the report. The SHENZHEN TIMEWAY TESTING LABORATORIES reserves the rights to withdraw it and to adopt any other remedies which may be appropriate.



Test Figure:

1. Condition: Low Channel

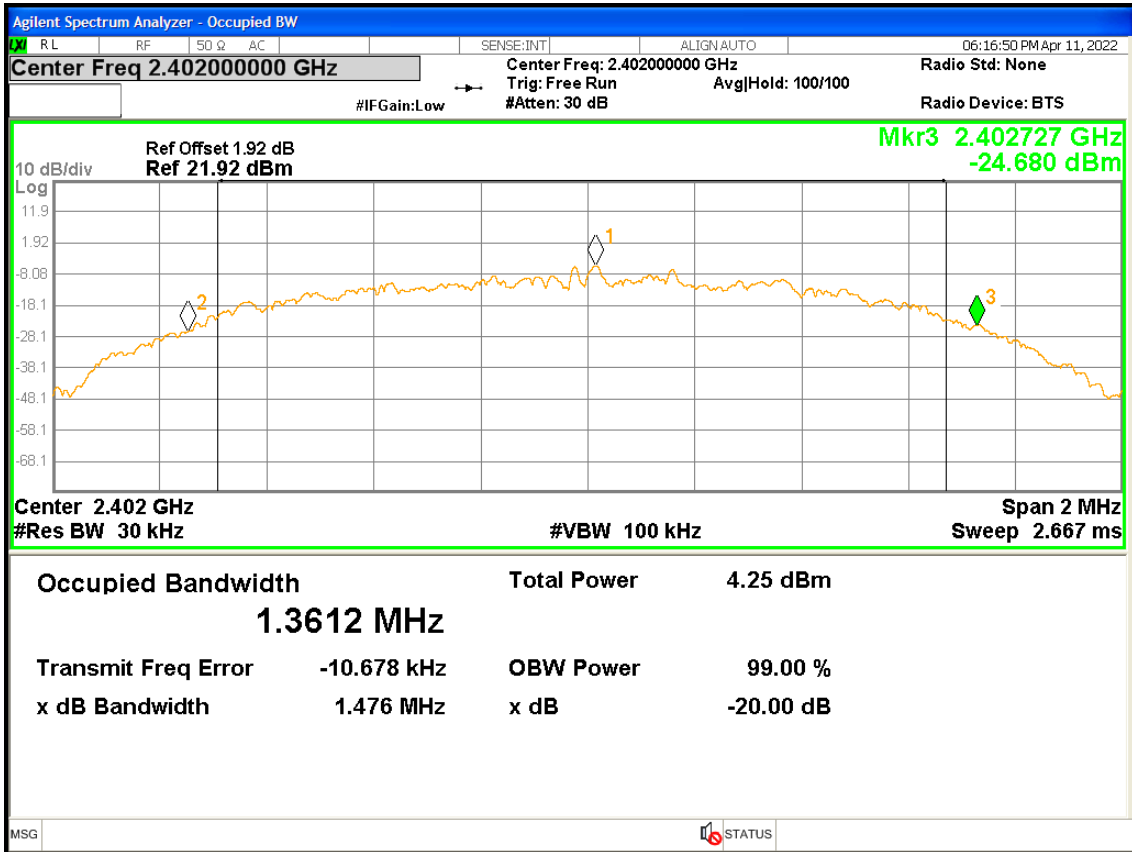

The report refers only to the sample tested and does not apply to the bulk. This report is issued in confidence to the client and it will be strictly treated as such by the SHENZHEN TIMEWAY TESTING LABORATORIES. It may not be reproduced rather in its entirety or in part and it may not be used for advertising. The client to whom the report is issued may, however, show or send it . or a certified copy there of prepared by the SHENZHEN TIMEWAY TESTING LABORATORIES. to his customer. Supplier or others persons directly concerned. SHENZHEN TIMEWAY TESTING LABORATORIES. will not, without the consent of the client enter into any discussion of correspondence with any third party concerning the contents of the report. In the event of the improper use of the report. The SHENZHEN TIMEWAY TESTING LABORATORIES. reserves the rights to withdraw it and to adopt any other remedies which may be appropriate.



2. Condition: Middle Channel

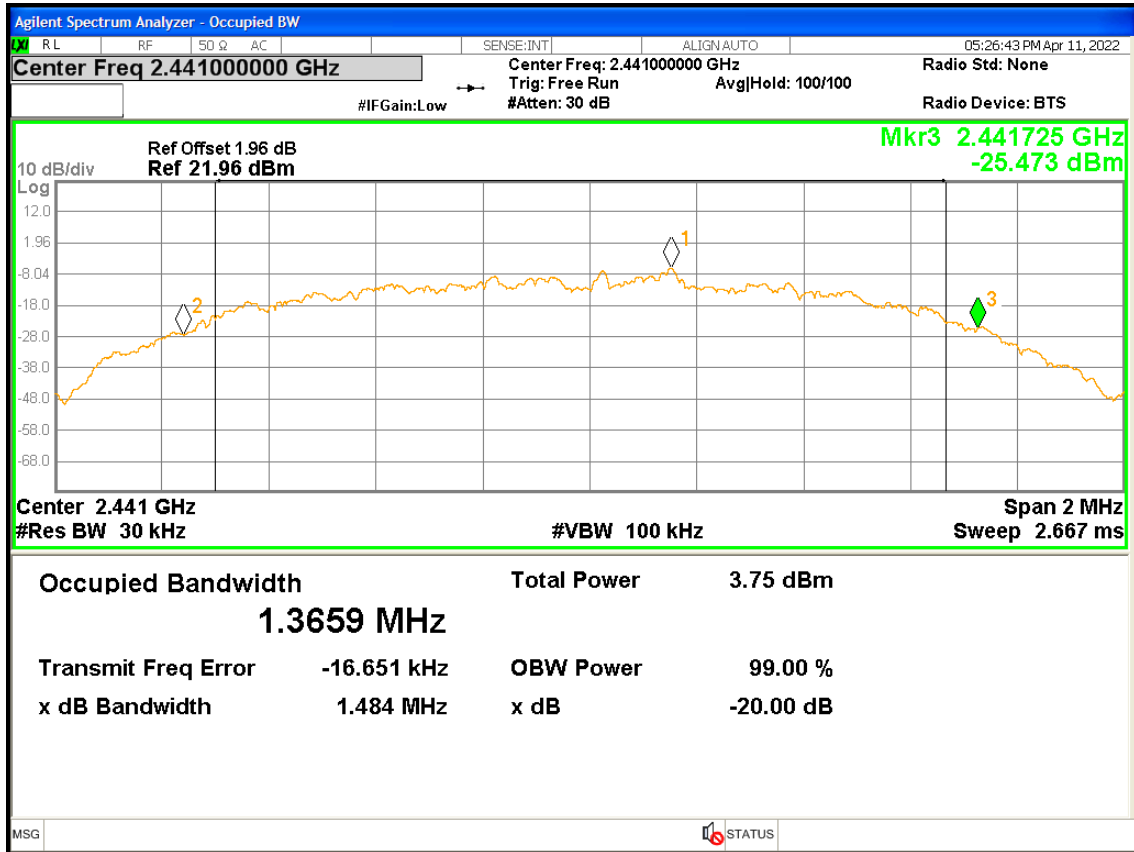

The report refers only to the sample tested and does not apply to the bulk. This report is issued in confidence to the client and it will be strictly treated as such by the SHENZHEN TIMEWAY TESTING LABORATORIES. It may not be reproduced rather in its entirety or in part and it may not be used for advertising. The client to whom the report is issued may, however, show or send it or a certified copy thereof prepared by the SHENZHEN TIMEWAY TESTING LABORATORIES to his customer. Supplier or others persons directly concerned. SHENZHEN TIMEWAY TESTING LABORATORIES will not, without the consent of the client enter into any discussion of correspondence with any third party concerning the contents of the report. In the event of the improper use of the report. The SHENZHEN TIMEWAY TESTING LABORATORIES reserves the rights to withdraw it and to adopt any other remedies which may be appropriate.



### 3. High Channel

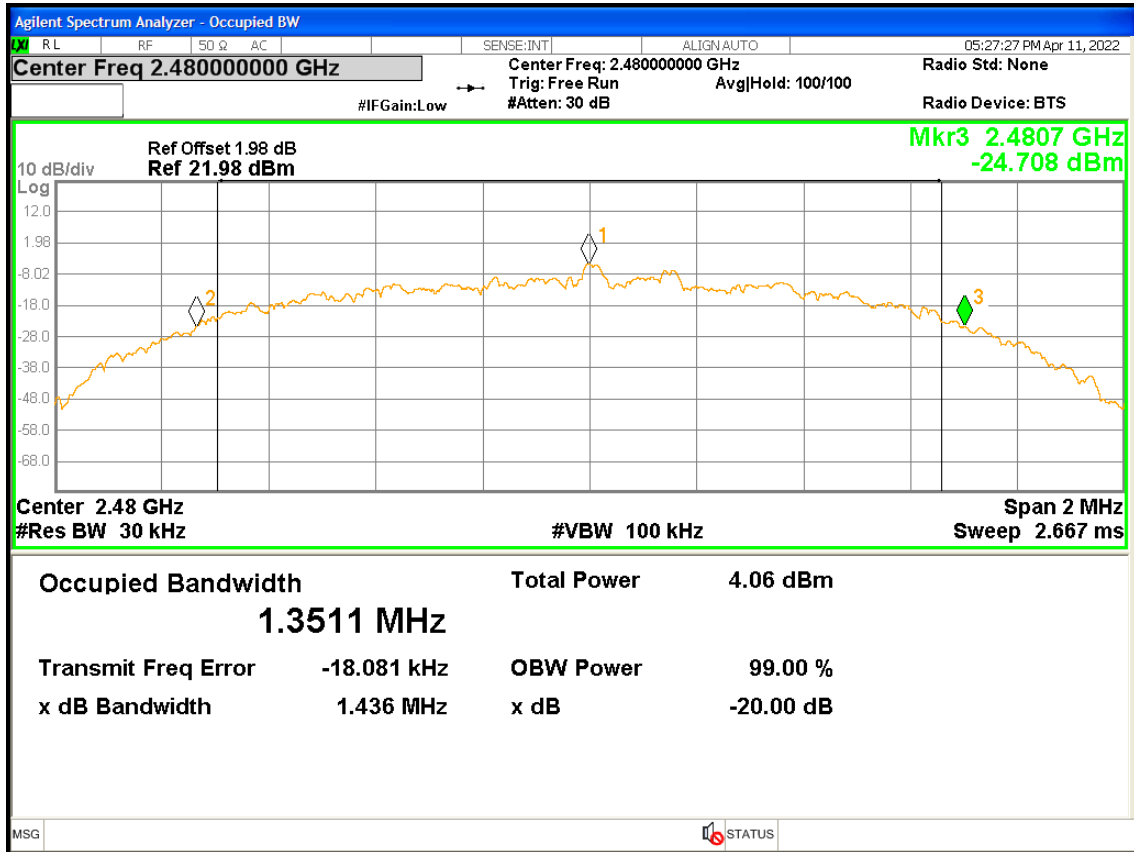

The report refers only to the sample tested and does not apply to the bulk.  
 This report is issued in confidence to the client and it will be strictly treated as such by the SHENZHEN TIMEWAY TESTING LABORATORIES. It may not be reproduced rather in its entirety or in part and it may not be used for advertising. The client to whom the report is issued may, however, show or send it or a certified copy thereof prepared by the SHENZHEN TIMEWAY TESTING LABORATORIES to his customer. Supplier or others persons directly concerned. SHENZHEN TIMEWAY TESTING LABORATORIES will not, without the consent of the client enter into any discussion of correspondence with any third party concerning the contents of the report.  
 In the event of the improper use of the report. The SHENZHEN TIMEWAY TESTING LABORATORIES reserves the rights to withdraw it and to adopt any other remedies which may be appropriate.



## 8. Maximum Output Power

### 8.1 Regulation

According to §15.247(b)(1), for frequency hopping systems operating in the 2400-2483.5 MHz band employing at least 75 non-overlapping hopping channels, and all frequency hopping systems in the 5725-5850 MHz band: 1 watt. For all other frequency hopping systems in the 2400-2483.5MHz band:0.125 watts. According to §15.247(b)(4), the conducted output power limit specified in paragraph (b) of this section is based on the use of antennas with directional gains that do not exceed 6 dBi. Except as shown in paragraph (c) of this section, if transmitting antennas of directional gain greater than 6 dBi are used, the conducted output power from the intentional radiator shall be reduced below the stated values in paragraphs (b)(1), (b)(2), and (b)(3) of this section, as appropriate, by the amount in dB that the directional gain of the antenna exceeds 6 dBi.

### 8.2 Limits of Maximum Output Power

The Maximum Output Power Measurement is 30dBm.

### 8.3 Test Procedure

1. Check the calibration of the measuring instrument (spectrum analyzer) using either an internal calibrator or a known signal from an external generator.
2. Set the spectrum analyzer as follows: Span = approximately 5 times the 20 dB bandwidth, centered on a hopping channel; RBW > the 20 dB bandwidth of the emission being measured; VBW = 10MHz, RBW=3MHz; Sweep = 60s; Detector function = PK; Trace = max hold
3. Measure the highest amplitude appearing on spectral display and record the level to calculate results.
4. Repeat above procedures until all frequencies measured were complete.

The report refers only to the sample tested and does not apply to the bulk.

This report is issued in confidence to the client and it will be strictly treated as such by the SHENZHEN TIMEWAY TESTING LABORATORIES. It may not be reproduced rather in its entirety or in part and it may not be used for adverting. The client to whom the report is issued may, however, show or send it . or a certified copy there of prepared by the SHENZHEN TIMEWAY TESTING LABORATORIES. to his customer. Supplier or others persons directly concerned. SHENZHEN TIMEWAY TESTING LABORATORIES. will not, without the consent of the client enter into any discussion of correspondence with any third party concerning the contents of the report.

In the event of the improper use of the report. The SHENZHEN TIMEWAY TESTING LABORATORIES. reserves the rights to withdraw it and to adopt any other remedies which may be appropriate.





**8.4 Test Results**

**Type of Modulation: GFSK**

EUT	AIOJET		Model	AIOJet G1P
Mode	Keep Transmitting		Input Voltage	120V~
Temperature	24 deg. C,		Humidity	56% RH
Channel	Channel Frequency (MHz)	Max. Power Output (dBm)	Peak Power Limit (dBm)	Pass/ Fail
		Peak		
Low	2402	0.91	30	Pass
Middle	2441	0.49	30	Pass
High	2480	0.38	30	Pass

Note: 1. the result basic equation calculation as follow:

$$\text{Max. Power Output} = \text{Power Reading} + \text{Cable loss} + \text{Attenuator}$$

2. The worst case was recorded
3. The Peak power was measured

**Type of Modulation: 11/4D-QPSK**

EUT	AIOJET		Model	AIOJet G1P
Mode	Keep Transmitting		Input Voltage	120V~
Temperature	24 deg. C,		Humidity	56% RH
Channel	Channel Frequency (MHz)	Max. Power Output (dBm)	Peak Power Limit (dBm)	Pass/ Fail
		Peak		
Low	2402	-1.01	30	Pass
Middle	2441	-1.46	30	Pass
High	2480	-1.58	30	Pass

Note: 1. the result basic equation calculation as follow:

$$\text{Max. Power Output} = \text{Power Reading} + \text{Cable loss} + \text{Attenuator}$$

2. The worst case was recorded
3. The Peak power was measured

The report refers only to the sample tested and does not apply to the bulk.

This report is issued in confidence to the client and it will be strictly treated as such by the SHENZHEN TIMEWAY TESTING LABORATORIES. It may not be reproduced rather in its entirety or in part and it may not be used for advertising. The client to whom the report is issued may, however, show or send it, or a certified copy thereof prepared by the SHENZHEN TIMEWAY TESTING LABORATORIES, to his customer. Supplier or others persons directly concerned. SHENZHEN TIMEWAY TESTING LABORATORIES, will not, without the consent of the client enter into any discussion of correspondence with any third party concerning the contents of the report. In the event of the improper use of the report. The SHENZHEN TIMEWAY TESTING LABORATORIES, reserves the rights to withdraw it and to adopt any other remedies which may be appropriate.



**Type of Modulation: 8DPSK**

EUT	AIOJET		Model	AIOJet G1P
Mode	Keep Transmitting		Input Voltage	120V~
Temperature	24 deg. C,		Humidity	56% RH
Channel	Channel Frequency (MHz)	Max. Power Output (dBm)	Peak Power Limit (dBm)	Pass/ Fail
		Peak		
Low	2402	-0.72	30	Pass
Middle	2441	-1.14	30	Pass
High	2480	-1.47	30	Pass

Note: 1. the result basic equation calculation as follow:

$$\text{Max. Power Output} = \text{Power Reading} + \text{Cable loss} + \text{Attenuator}$$

2. The worst case was recorded
3. The Peak power was measured

The report refers only to the sample tested and does not apply to the bulk.

This report is issued in confidence to the client and it will be strictly treated as such by the SHENZHEN TIMEWAY TESTING LABORATORIES. It may not be reproduced rather in its entirety or in part and it may not be used for adverting. The client to whom the report is issued may, however, show or send it . or a certified copy there of prepared by the SHENZHEN TIMEWAY TESTING LABORATORIES. to his customer. Supplier or others persons directly concerned. SHENZHEN TIMEWAY TESTING LABORATORIES. will not, without the consent of the client enter into any discussion of correspondence with any third party concerning the contents of the report.

In the event of the improper use of the report. The SHENZHEN TIMEWAY TESTING LABORATORIES. reserves the rights to withdraw it and to adopt any other remedies which may be appropriate.



## 9. Carrier Frequency Separation

### 9.1 Regulation

According to §15.247(a)(1), frequency hopping systems shall have hopping channel carrier frequencies separated by a minimum of 25 kHz or the 20 dB bandwidth of the hopping channel, whichever is greater. Alternatively, frequency hopping systems operating in the 2400-2483.5 MHz band may have hopping channel carrier frequencies that are separated by 25 kHz or two-thirds of the 20 dB bandwidth of the hopping channel, whichever is greater, provided the systems operate with an output power no greater than 125 mW.

### 9.2 Limits of Carrier Frequency Separation

The Maximum Power Spectral Density Measurement is 25kHz or two-thirds of the 20dB bandwidth of the hopping Channel which is great.

### 9.3 Test Procedure

1. Check the calibration of the measuring instrument using either an internal calibrator or a known signal from an external generator.
2. Set the spectrum analyzer as follows: Span = wide enough to capture the peaks of two adjacent channels: Resolution (or IF) Bandwidth (RBW)  $\geq$  1% of the span; Video (or Average) Bandwidth (VBW)  $\geq$  RBW; Sweep = auto; Detector function = peak; Trace = max hold
3. Measure the separation between the peaks of the adjacent channels using the marker-delta function.
4. Repeat above procedures until all frequencies measured were complete.

The report refers only to the sample tested and does not apply to the bulk.

This report is issued in confidence to the client and it will be strictly treated as such by the SHENZHEN TIMEWAY TESTING LABORATORIES. It may not be reproduced rather in its entirety or in part and it may not be used for advertising. The client to whom the report is issued may, however, show or send it or a certified copy thereof prepared by the SHENZHEN TIMEWAY TESTING LABORATORIES to his customer. Supplier or others persons directly concerned. SHENZHEN TIMEWAY TESTING LABORATORIES will not, without the consent of the client enter into any discussion of correspondence with any third party concerning the contents of the report.

In the event of the improper use of the report. The SHENZHEN TIMEWAY TESTING LABORATORIES reserves the rights to withdraw it and to adopt any other remedies which may be appropriate.



**9.4 Test Result**

**Type of Modulation: GFSK**

EUT	AIOJET	Model	AIOJet G1P
Mode	Hopping On	Input Voltage	120V~
Temperature	24 deg. C,	Humidity	56% RH
Carrier Frequency Separation		Limit	Pass/ Fail
0.979MHz		≥ 25 kHz or 2/3 of the 20 dB bandwidth	Pass

**Test Plots**

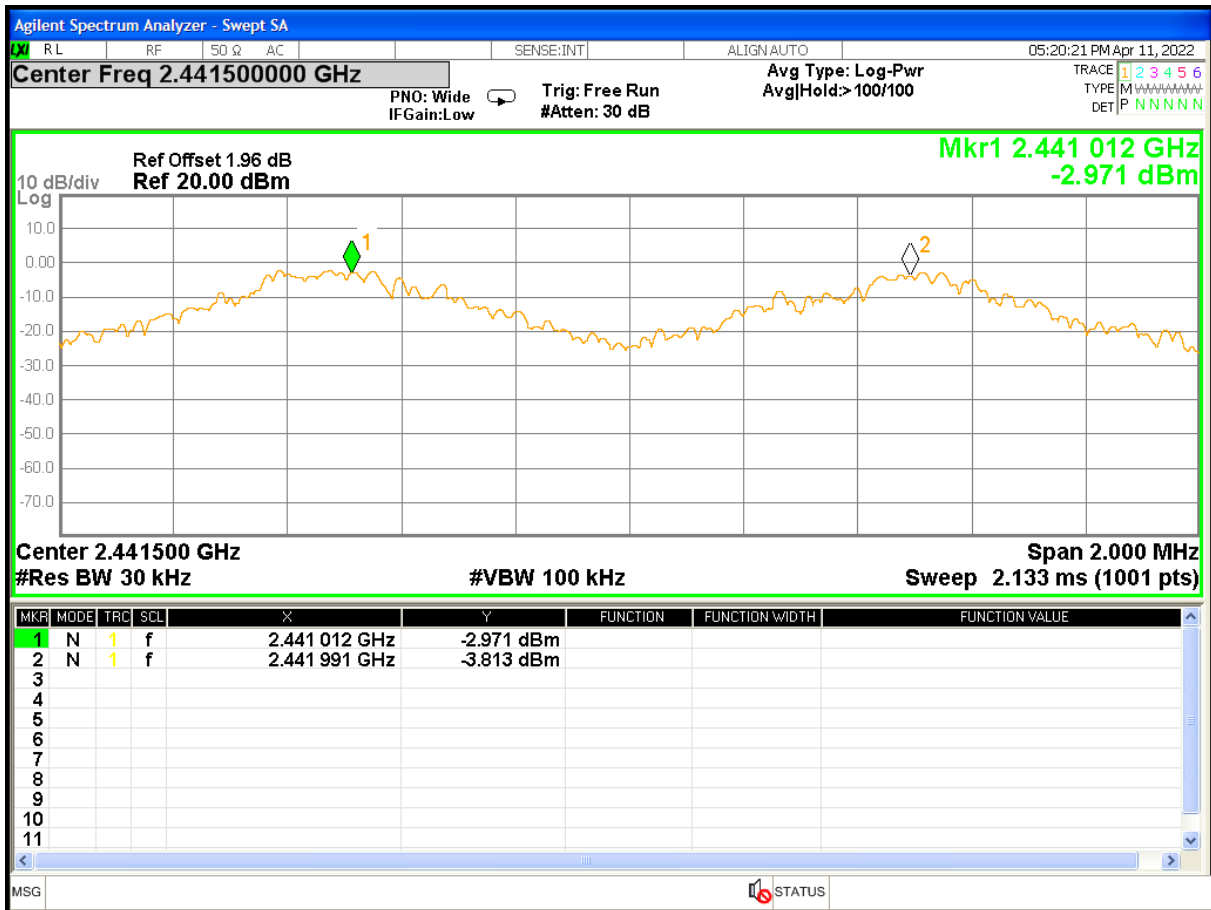

The report refers only to the sample tested and does not apply to the bulk.  
 This report is issued in confidence to the client and it will be strictly treated as such by the SHENZHEN TIMEWAY TESTING LABORATORIES. It may not be reproduced rather in its entirety or in part and it may not be used for adverting. The client to whom the report is issued may, however, show or send it . or a certified copy there of prepared by the SHENZHEN TIMEWAY TESTING LABORATORIES. to his customer. Supplier or others persons directly concerned. SHENZHEN TIMEWAY TESTING LABORATORIES. will not, without the consent of the client enter into any discussion of correspondence with any third party concerning the contents of the report.  
 In the event of the improper use of the report. The SHENZHEN TIMEWAY TESTING LABORATORIES. reserves the rights to withdraw it and to adopt any other remedies which may be appropriate.



**Type of Modulation:  $\pi/4$ D-QPSK**

EUT	AIOJET	Model	AIOJet G1P
Mode	Hopping On	Input Voltage	120V~
Temperature	24 deg. C,	Humidity	56% RH
Carrier Frequency Separation		Limit	Pass/ Fail
0.992MHz		$\geq 25$ kHz or 2/3 of 20 dB bandwidth	Pass

**Test Plots**

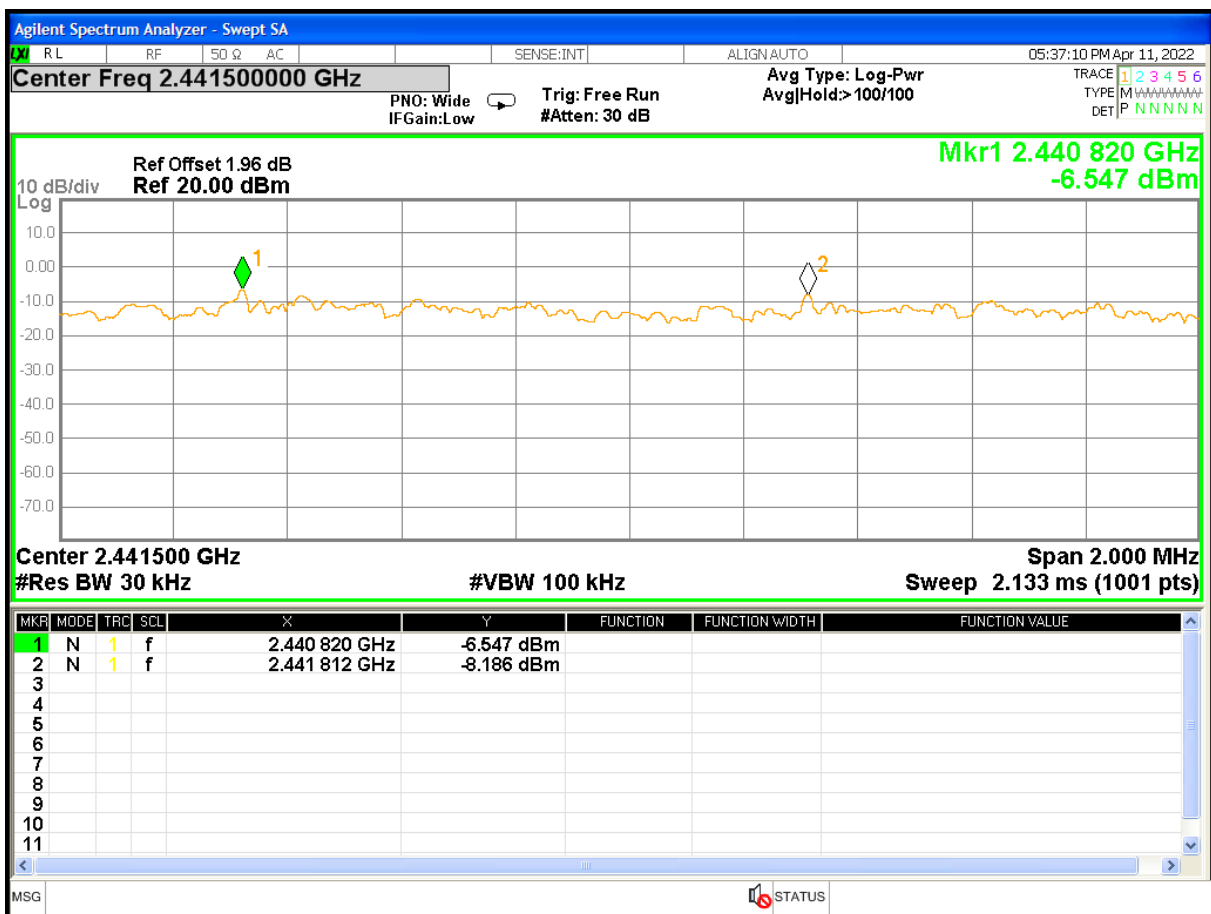

The report refers only to the sample tested and does not apply to the bulk. This report is issued in confidence to the client and it will be strictly treated as such by the SHENZHEN TIMEWAY TESTING LABORATORIES. It may not be reproduced rather in its entirety or in part and it may not be used for advertising. The client to whom the report is issued may, however, show or send it, or a certified copy thereof prepared by the SHENZHEN TIMEWAY TESTING LABORATORIES, to his customer. Supplier or others persons directly concerned. SHENZHEN TIMEWAY TESTING LABORATORIES, will not, without the consent of the client enter into any discussion of correspondence with any third party concerning the contents of the report. In the event of the improper use of the report. The SHENZHEN TIMEWAY TESTING LABORATORIES, reserves the rights to withdraw it and to adopt any other remedies which may be appropriate.



**Type of Modulation: 8DPSK**

EUT	AIOJET	Model	AIOJet G1P
Mode	Hopping On	Input Voltage	120V~
Temperature	24 deg. C,	Humidity	56% RH
Carrier Frequency Separation		Limit	Pass/ Fail
1.012MHz		≥ 25 kHz or 2/3 of 20 dB bandwidth	Pass

**Test Plots**

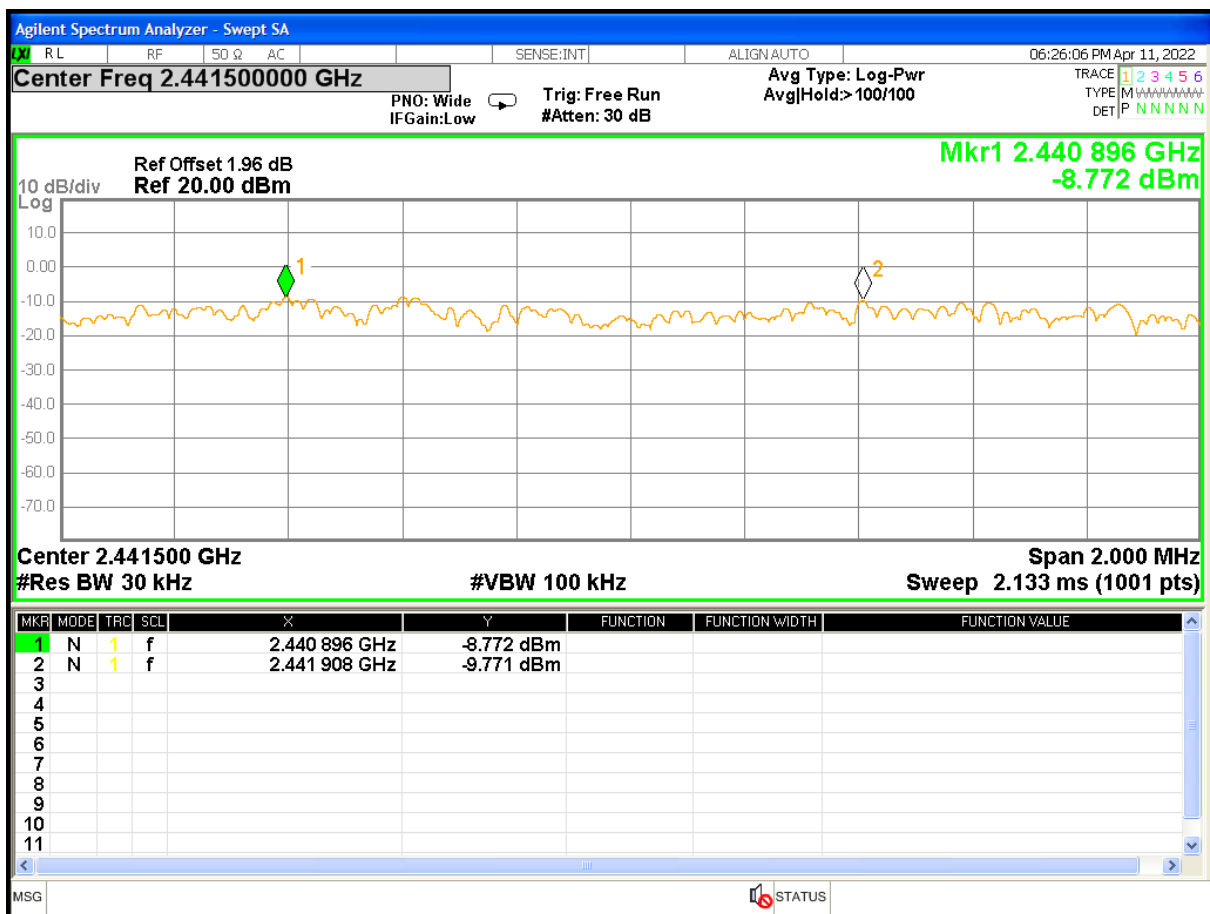

The report refers only to the sample tested and does not apply to the bulk.

This report is issued in confidence to the client and it will be strictly treated as such by the SHENZHEN TIMEWAY TESTING LABORATORIES. It may not be reproduced rather in its entirety or in part and it may not be used for adverting. The client to whom the report is issued may, however, show or send it . or a certified copy there of prepared by the SHENZHEN TIMEWAY TESTING LABORATORIES. to his customer. Supplier or others persons directly concerned. SHENZHEN TIMEWAY TESTING LABORATORIES. will not, without the consent of the client enter into any discussion of correspondence with any third party concerning the contents of the report.

In the event of the improper use of the report. The SHENZHEN TIMEWAY TESTING LABORATORIES. reserves the rights to withdraw it and to adopt any other remedies which may be appropriate.



## **10. Number of Hopping Channels**

### **10.1 Regulation**

According to §15.247(a)(1)(iii), frequency hopping systems in the 2400-2483.5 MHz band shall use at least 15 channels. The average time of occupancy on any channel shall not be greater than 0.4 seconds within a period of 0.4 seconds multiplied by the number of hopping channels employed. Frequency hopping systems may avoid or suppress transmissions on a particular hopping frequency provided that a minimum of 15 channels are used. According to §15.247(b)(1), for frequency hopping systems operating in the 2400-2483.5 MHz band employing at least 75 non-overlapping hopping channels, and all frequency hopping systems in the 5725-5850 MHz band: 1 watt. For all other frequency hopping systems in the 2400-2483.5 MHz band: 0.125 watts.

### **10.2 Limits of Number of Hopping Channels**

The frequency hopping systems in the 2400-2483.5MHz band shall use at least 15 channels.

### **10.3 Test Procedure**

1. Check the calibration of the measuring instrument using either an internal calibrator or a known signal from an external generator.
2. Set the spectrum analyzer as follows: Span = the frequency band of operation; RBW=300 kHz, VBW=300 kHz; Sweep = auto; Detector function = peak; Trace = max hold
3. Record the number of hopping channels.

The report refers only to the sample tested and does not apply to the bulk.

This report is issued in confidence to the client and it will be strictly treated as such by the SHENZHEN TIMEWAY TESTING LABORATORIES. It may not be reproduced rather in its entirety or in part and it may not be used for advertising. The client to whom the report is issued may, however, show or send it or a certified copy thereof prepared by the SHENZHEN TIMEWAY TESTING LABORATORIES to his customer. Supplier or others persons directly concerned. SHENZHEN TIMEWAY TESTING LABORATORIES will not, without the consent of the client enter into any discussion of correspondence with any third party concerning the contents of the report.

In the event of the improper use of the report. The SHENZHEN TIMEWAY TESTING LABORATORIES reserves the rights to withdraw it and to adopt any other remedies which may be appropriate.



**10.4 Test Result**

**Type of Modulation: GFSK**

EUT	AIOJET	Model	AIOJet G1P	
Mode	Hopping On	Input Voltage	120V~	
Temperature	24 deg. C,	Humidity	56% RH	
Operating Frequency	Number of hopping channels	Limit	Pass/ Fail	
2402-2480MHz	79	≥ 15	Pass	

**Test Plot**

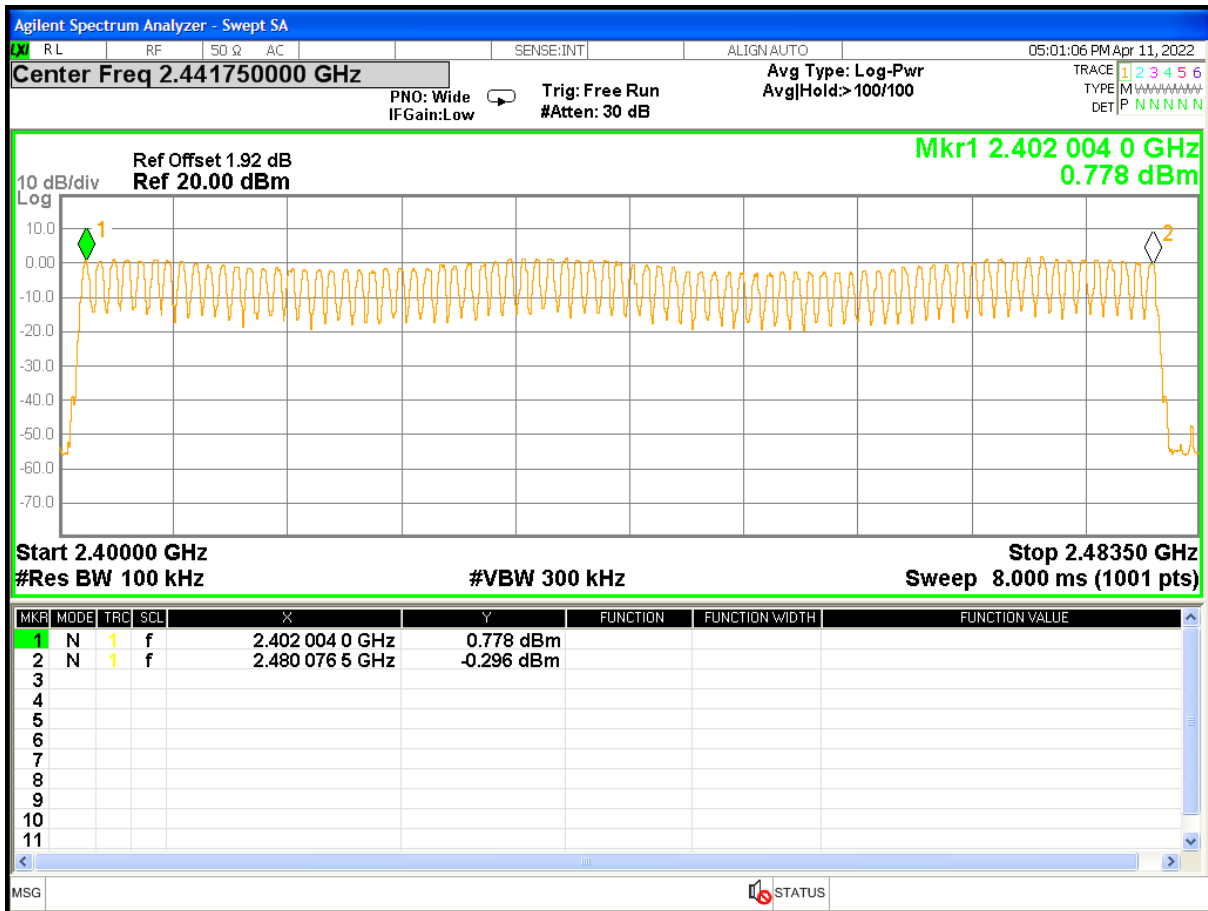

The report refers only to the sample tested and does not apply to the bulk.  
 This report is issued in confidence to the client and it will be strictly treated as such by the SHENZHEN TIMEWAY TESTING LABORATORIES. It may not be reproduced rather in its entirety or in part and it may not be used for advertizing. The client to whom the report is issued may, however, show or send it . or a certified copy there of prepared by the SHENZHEN TIMEWAY TESTING LABORATORIES. to his customer. Supplier or others persons directly concerned. SHENZHEN TIMEWAY TESTING LABORATORIES. will not, without the consent of the client enter into any discussion of correspondence with any third party concerning the contents of the report.  
 In the event of the improper use of the report. The SHENZHEN TIMEWAY TESTING LABORATORIES. reserves the rights to withdraw it and to adopt any other remedies which may be appropriate.





**Type of Modulation:  $\pi/4$ D-QPSK**

EUT	AIOJET	Model	AIOJet G1P
Mode	Hopping On	Input Voltage	120V~
Temperature	24 deg. C,	Humidity	56% RH
Operating Frequency	Number of hopping channels	Limit	Pass/ Fail
2402-2480MHz	79	$\geq 15$	Pass

**Test Plot**

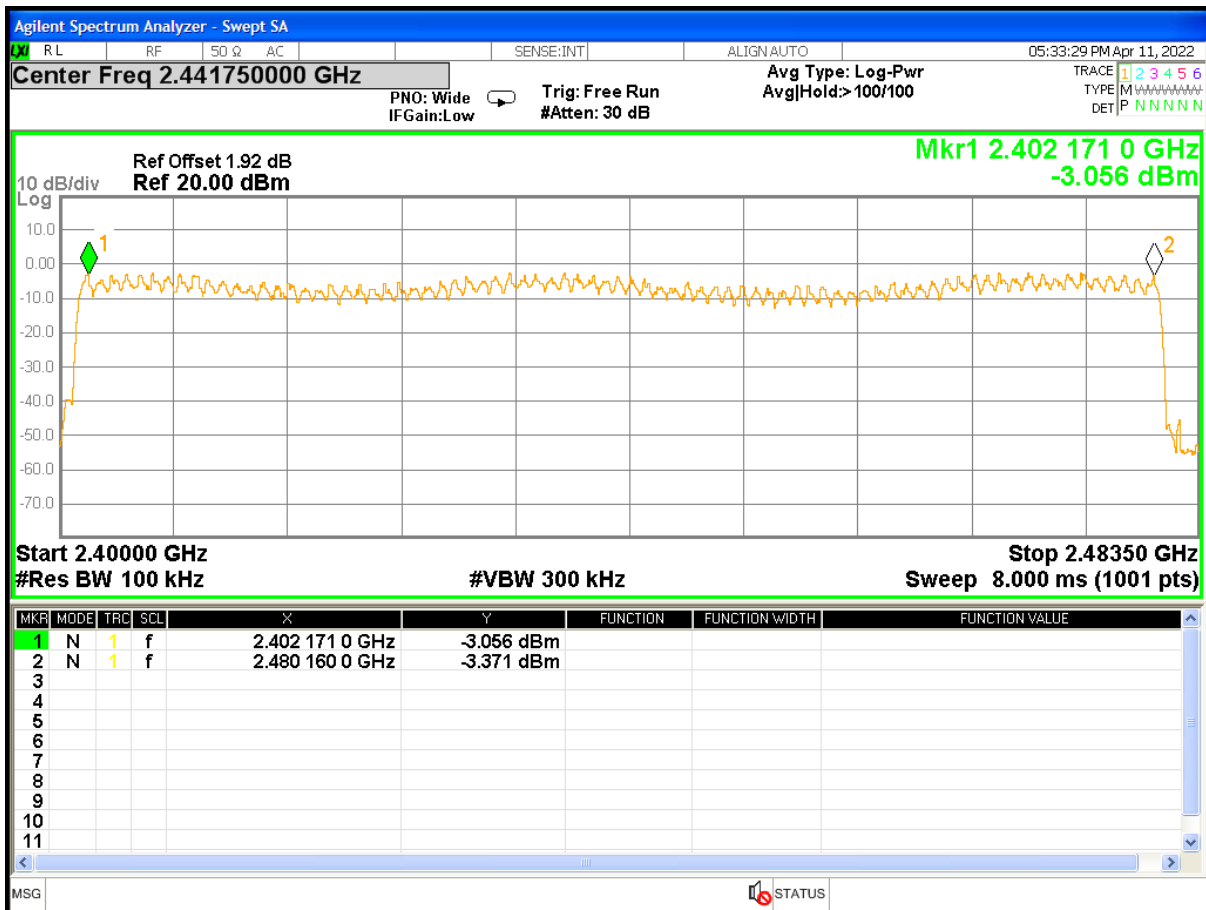

The report refers only to the sample tested and does not apply to the bulk.  
 This report is issued in confidence to the client and it will be strictly treated as such by the SHENZHEN TIMEWAY TESTING LABORATORIES. It may not be reproduced rather in its entirety or in part and it may not be used for advertizing. The client to whom the report is issued may, however, show or send it . or a certified copy there of prepared by the SHENZHEN TIMEWAY TESTING LABORATORIES. to his customer. Supplier or others persons directly concerned. SHENZHEN TIMEWAY TESTING LABORATORIES. will not, without the consent of the client enter into any discussion of correspondence with any third party concerning the contents of the report.  
 In the event of the improper use of the report. The SHENZHEN TIMEWAY TESTING LABORATORIES. reserves the rights to withdraw it and to adopt any other remedies which may be appropriate.



**Type of Modulation: 8DPSK**

EUT	AIOJET		Model	AIOJet G1P
Mode	Hopping On		Input Voltage	120V~
Temperature	24 deg. C,		Humidity	56% RH
Operating Frequency	Number of hopping channels		Limit	Pass/ Fail
2402-2480MHz	79		≥ 15	Pass

**Test Plot**

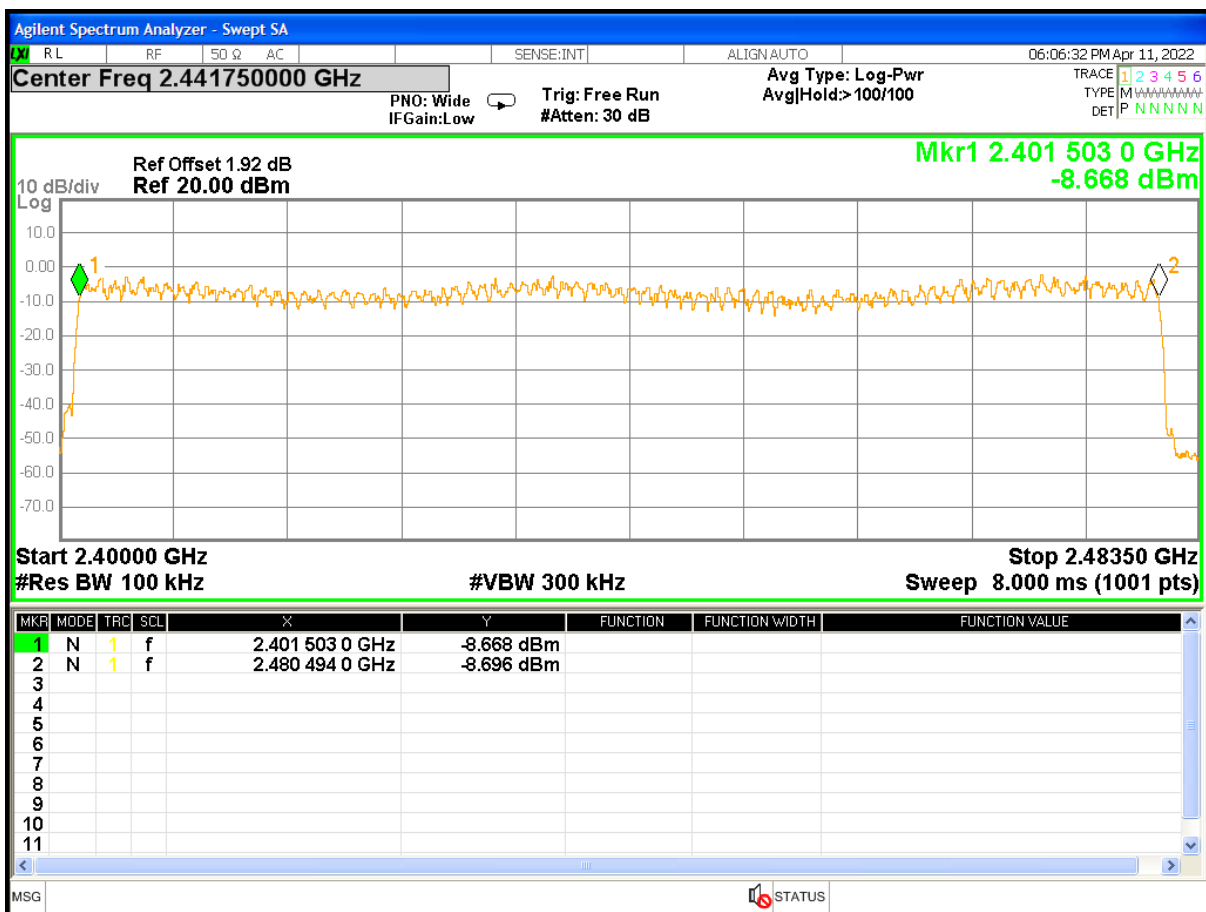

The report refers only to the sample tested and does not apply to the bulk.  
 This report is issued in confidence to the client and it will be strictly treated as such by the SHENZHEN TIMEWAY TESTING LABORATORIES. It may not be reproduced rather in its entirety or in part and it may not be used for adverting. The client to whom the report is issued may, however, show or send it . or a certified copy there of prepared by the SHENZHEN TIMEWAY TESTING LABORATORIES. to his customer. Supplier or others persons directly concerned. SHENZHEN TIMEWAY TESTING LABORATORIES. will not, without the consent of the client enter into any discussion of correspondence with any third party concerning the contents of the report.  
 In the event of the improper use of the report. The SHENZHEN TIMEWAY TESTING LABORATORIES. reserves the rights to withdraw it and to adopt any other remedies which may be appropriate.



## **11. Time of Occupancy (Dwell Time)**

### **11.1 Regulation**

According to §15.247(a)(1)(iii), frequency hopping systems in the 2400-2483.5 MHz band shall use at least 15 channels. The average time of occupancy on any channel shall not be greater than 0.4 seconds within a period of 0.4 seconds multiplied by the number of hopping channels employed. Frequency hopping systems may avoid or suppress transmissions on a particular hopping frequency provided that a minimum of 15 channels are used.

### **11.2 Limits of Carrier Frequency Separation**

The average time of occupancy on any channel shall not be greater than 0.4 seconds within a period of 0.4 seconds multiplied by the number of hopping channels employed

### **11.3 Test Procedure**

1. Check the calibration of the measuring instrument using either an internal calibrator or a known signal from an external generator.
2. Set the spectrum analyzer as follows: Span = zero span, centered on a hopping channel; RBW = 1 MHz; VBW  $\geq$  RBW; Sweep = as necessary to capture the entire dwell time per hopping channel; Detector function = peak; Trace = max hold
3. Measure the dwell time using the marker-delta function.
4. Repeat above procedures until all frequencies measured were complete.
5. Repeat this test for different modes of operation (e.g., data rate, modulation format, etc.), if applicable.

The report refers only to the sample tested and does not apply to the bulk.

This report is issued in confidence to the client and it will be strictly treated as such by the SHENZHEN TIMEWAY TESTING LABORATORIES. It may not be reproduced rather in its entirety or in part and it may not be used for advertising. The client to whom the report is issued may, however, show or send it or a certified copy thereof prepared by the SHENZHEN TIMEWAY TESTING LABORATORIES to his customer. Supplier or others persons directly concerned. SHENZHEN TIMEWAY TESTING LABORATORIES will not, without the consent of the client enter into any discussion of correspondence with any third party concerning the contents of the report.

In the event of the improper use of the report. The SHENZHEN TIMEWAY TESTING LABORATORIES reserves the rights to withdraw it and to adopt any other remedies which may be appropriate.



#### 11.4 Test Result

Mode	Frequency (MHz)	Antenna	Pulse Time (ms)	Total Dwell Time (ms)	Burst Count	Period Time (ms)	Limit (ms)	Verdict
1-DH5	2402	Ant1	2.883	308.481	107	31600	400	Pass
2-DH5	2402	Ant1	2.889	312.012	108	31600	400	Pass
3-DH5	2402	Ant1	2.891	306.446	106	31600	400	Pass

**Note: Only the worst cases were recorded.**

The report refers only to the sample tested and does not apply to the bulk.

This report is issued in confidence to the client and it will be strictly treated as such by the SHENZHEN TIMEWAY TESTING LABORATORIES. It may not be reproduced rather in its entirety or in part and it may not be used for advertising. The client to whom the report is issued may, however, show or send it or a certified copy thereof prepared by the SHENZHEN TIMEWAY TESTING LABORATORIES to his customer. Supplier or others persons directly concerned. SHENZHEN TIMEWAY TESTING LABORATORIES will not, without the consent of the client enter into any discussion of correspondence with any third party concerning the contents of the report.

In the event of the improper use of the report. The SHENZHEN TIMEWAY TESTING LABORATORIES reserves the rights to withdraw it and to adopt any other remedies which may be appropriate.



**Type of Modulation: GFPSK**

Test Plots:

**DH5**

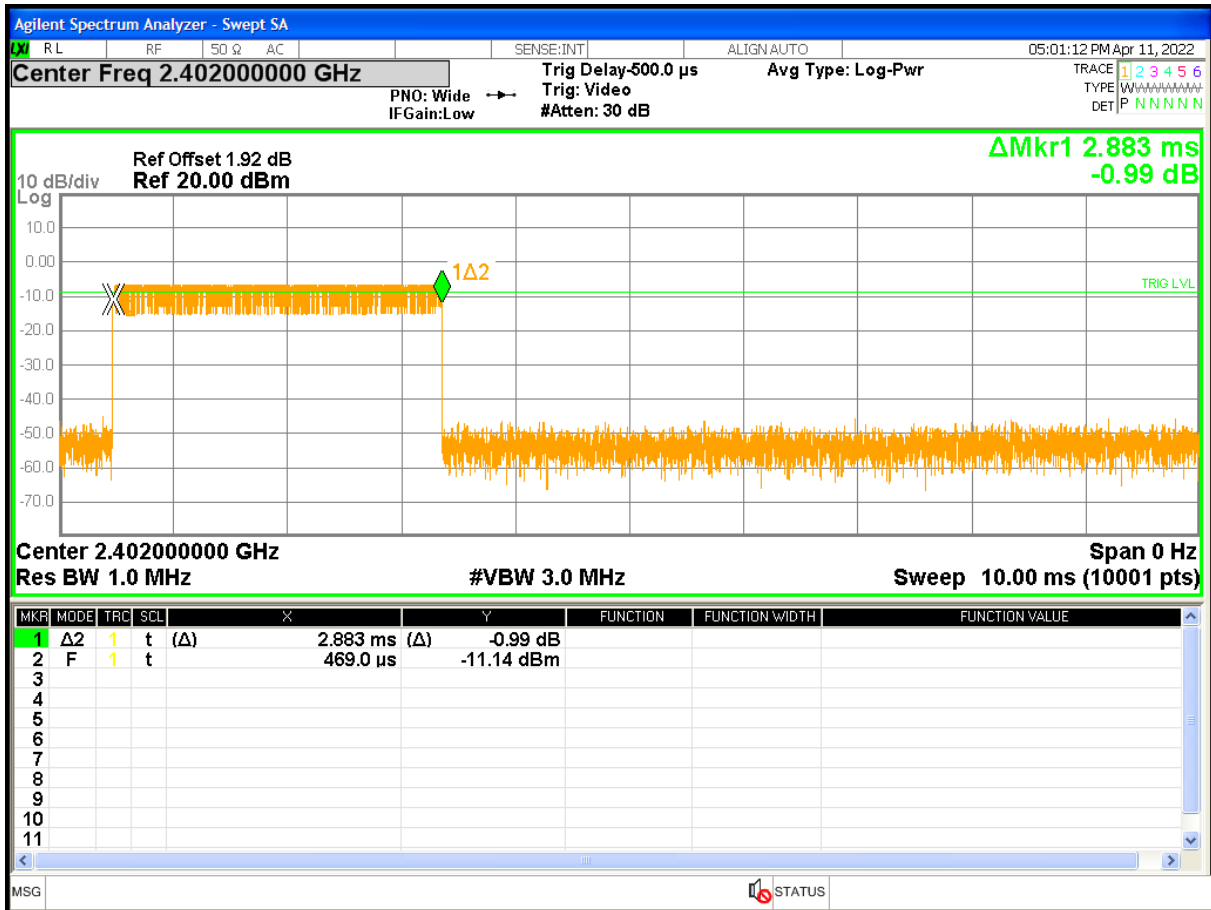

The report refers only to the sample tested and does not apply to the bulk.  
 This report is issued in confidence to the client and it will be strictly treated as such by the SHENZHEN TIMEWAY TESTING LABORATORIES. It may not be reproduced rather in its entirety or in part and it may not be used for advertizing. The client to whom the report is issued may, however, show or send it . or a certified copy there of prepared by the SHENZHEN TIMEWAY TESTING LABORATORIES. to his customer. Supplier or others persons directly concerned. SHENZHEN TIMEWAY TESTING LABORATORIES. will not, without the consent of the client enter into any discussion of correspondence with any third party concerning the contents of the report.  
 In the event of the improper use of the report. The SHENZHEN TIMEWAY TESTING LABORATORIES. reserves the rights to withdraw it and to adopt any other remedies which may be appropriate.



Type of Modulation:  $\pi/4$ D-QPSK

Test Plots:

2DH5

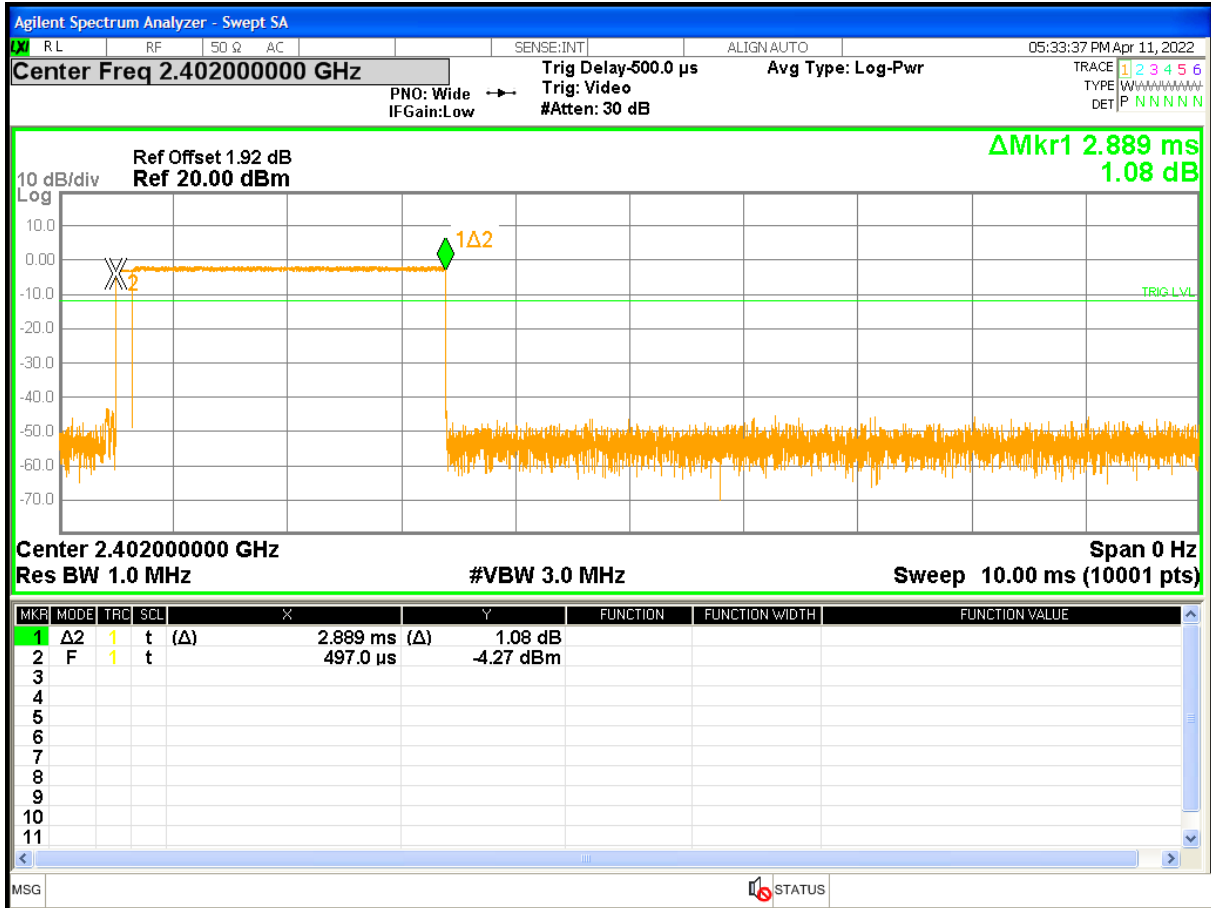

The report refers only to the sample tested and does not apply to the bulk.

This report is issued in confidence to the client and it will be strictly treated as such by the SHENZHEN TIMEWAY TESTING LABORATORIES. It may not be reproduced rather in its entirety or in part and it may not be used for adverting. The client to whom the report is issued may, however, show or send it, or a certified copy thereof prepared by the SHENZHEN TIMEWAY TESTING LABORATORIES, to his customer. Supplier or others persons directly concerned. SHENZHEN TIMEWAY TESTING LABORATORIES, will not, without the consent of the client enter into any discussion of correspondence with any third party concerning the contents of the report.

In the event of the improper use of the report. The SHENZHEN TIMEWAY TESTING LABORATORIES, reserves the rights to withdraw it and to adopt any other remedies which may be appropriate.



**Type of Modulation: 8DPSK**

Test Plots:

**3DH5**

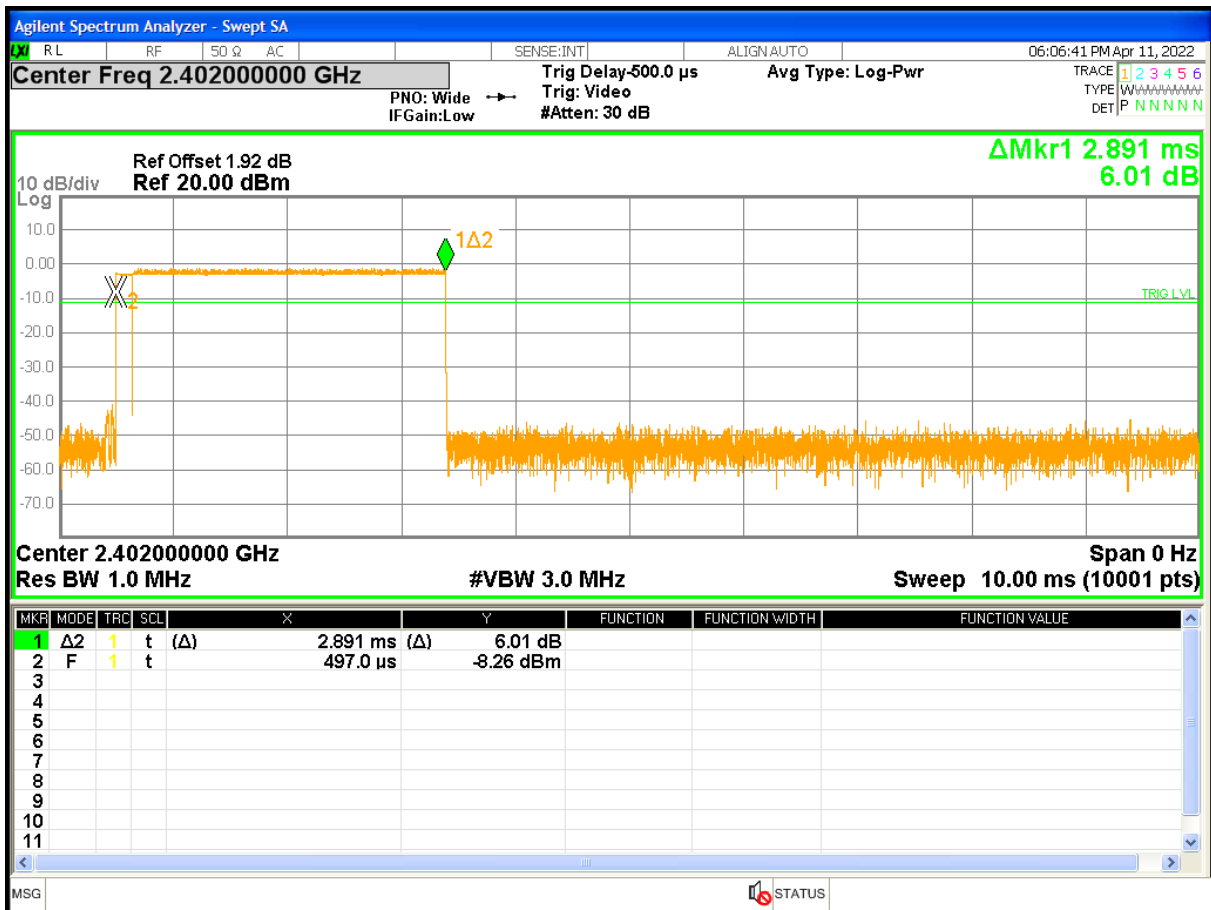

The report refers only to the sample tested and does not apply to the bulk.  
 This report is issued in confidence to the client and it will be strictly treated as such by the SHENZHEN TIMEWAY TESTING LABORATORIES. It may not be reproduced rather in its entirety or in part and it may not be used for adverting. The client to whom the report is issued may, however, show or send it . or a certified copy there of prepared by the SHENZHEN TIMEWAY TESTING LABORATORIES. to his customer. Supplier or others persons directly concerned. SHENZHEN TIMEWAY TESTING LABORATORIES. will not, without the consent of the client enter into any discussion of correspondence with any third party concerning the contents of the report.  
 In the event of the improper use of the report. The SHENZHEN TIMEWAY TESTING LABORATORIES. reserves the rights to withdraw it and to adopt any other remedies which may be appropriate.



## 12 Out of Band Measurement

### 12.1 Test Setup

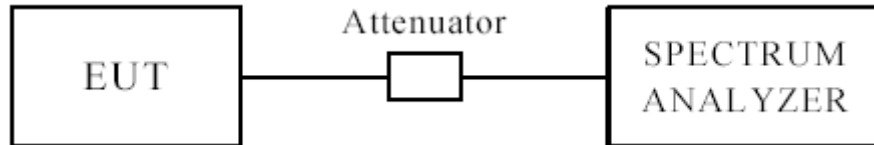

The restricted band requirement based on radiated emission test; please see the clause 6 for the test setup

### 12.2 Limits of Out of Band Emissions Measurement

1. Below  $-20\text{dB}$  of the highest emission level of operating band (in 100kHz Resolution Bandwidth).
2. Fall in the restricted bands listed in section 15.205. The maximum permitted average field strength is listed in section 15.209.

### 12.3 Test Procedure

For signals in the restricted bands above and below the 2.4-2.483GHz allocated band a measurement was made of radiated emission test. Peak values with  $\text{RBW}=\text{VBW}=1\text{MHz}$  and PK detector.

For bandage test, the spectrum set as follows:  $\text{RBW}=100\text{ kHz}$ ,  $\text{VBW}=300\text{ kHz}$ . A conducted measurement used

Note: 1. For band-edge measurement, the frequency from 30MHz-25GHz was tested. And It met the FCC rule.

The report refers only to the sample tested and does not apply to the bulk.

This report is issued in confidence to the client and it will be strictly treated as such by the SHENZHEN TIMEWAY TESTING LABORATORIES. It may not be reproduced rather in its entirety or in part and it may not be used for adverting. The client to whom the report is issued may, however, show or send it . or a certified copy there of prepared by the SHENZHEN TIMEWAY TESTING LABORATORIES. to his customer. Supplier or others persons directly concerned. SHENZHEN TIMEWAY TESTING LABORATORIES. will not, without the consent of the client enter into any discussion of correspondence with any third party concerning the contents of the report.

In the event of the improper use of the report. The SHENZHEN TIMEWAY TESTING LABORATORIES. reserves the rights to withdraw it and to adopt any other remedies which may be appropriate.





**Type of Modulation: GFSK**

**12.4 Band Edge Test Result**

Product:	AIOJET	Test Mode:	Low Channel
Mode	Keeping Transmitting	Input Voltage	120V~
Temperature	24 deg. C	Humidity	56% RH
Test Result:	Pass	Detector	PK

**Test Figure:**

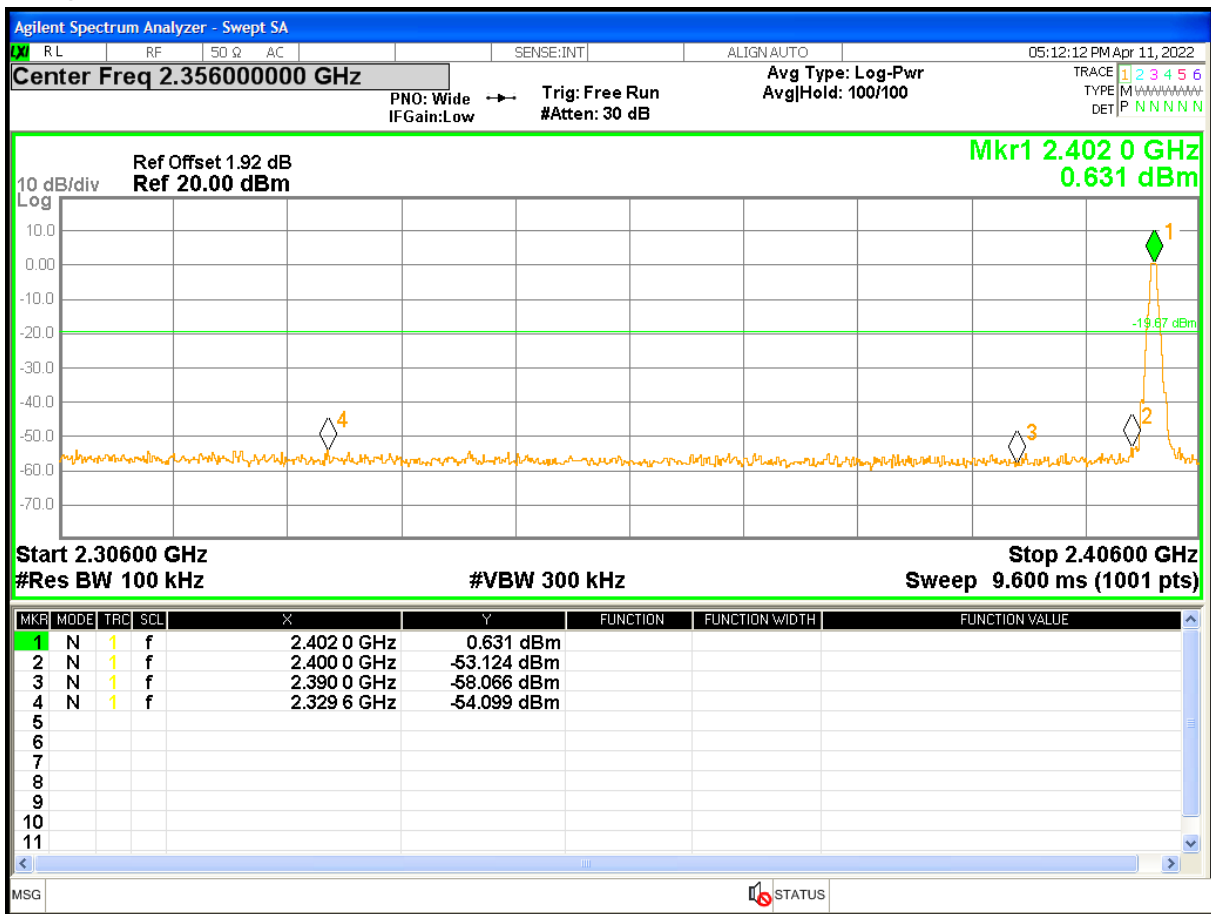

The report refers only to the sample tested and does not apply to the bulk.

This report is issued in confidence to the client and it will be strictly treated as such by the SHENZHEN TIMEWAY TESTING LABORATORIES. It may not be reproduced rather in its entirety or in part and it may not be used for adverting. The client to whom the report is issued may, however, show or send it . or a certified copy there of prepared by the SHENZHEN TIMEWAY TESTING LABORATORIES. to his customer. Supplier or others persons directly concerned. SHENZHEN TIMEWAY TESTING LABORATORIES. will not, without the consent of the client enter into any discussion of correspondence with any third party concerning the contents of the report.

In the event of the improper use of the report. The SHENZHEN TIMEWAY TESTING LABORATORIES. reserves the rights to withdraw it and to adopt any other remedies which may be appropriate.



**Type of Modulation: GFSK**

**12.4 Band Edge Test Result**

Product:	AIOJET	Test Mode:	High Channel
Mode	Keeping Transmitting	Input Voltage	120V~
Temperature	24 deg. C,	Humidity	56% RH
Test Result:	Pass	Detector	PK

**Test Figure:**

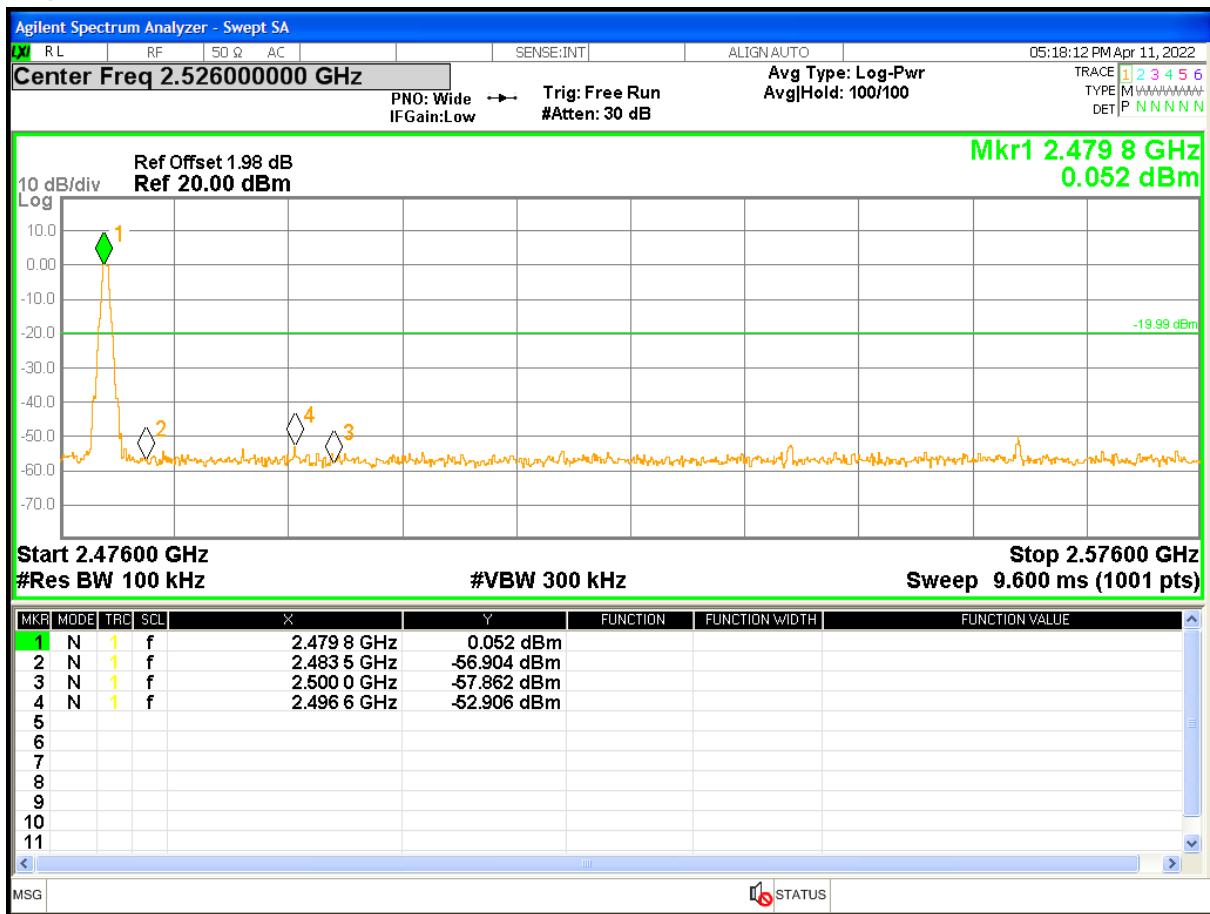

The report refers only to the sample tested and does not apply to the bulk.

This report is issued in confidence to the client and it will be strictly treated as such by the SHENZHEN TIMEWAY TESTING LABORATORIES. It may not be reproduced rather in its entirety or in part and it may not be used for advertng. The client to whom the report is issued may, however, show or send it . or a certified copy there of prepared by the SHENZHEN TIMEWAY TESTING LABORATORIES. to his customer. Supplier or others persons directly concerned. SHENZHEN TIMEWAY TESTING LABORATORIES. will not, without the consent of the client enter into any discussion of correspondence with any third party concerning the contents of the report.

In the event of the improper use of the report. The SHENZHEN TIMEWAY TESTING LABORATORIES. reserves the rights to withdraw it and to adopt any other remedies which may be appropriate.



**Type of Modulation: GFSK**

**12.4 Band Edge Test Result**

Product:	AIOJET	Test Mode:	Hopping mode
Mode	Hopping On	Input Voltage	120V~
Temperature	24 deg. C,	Humidity	56% RH
Test Result:	Pass	Detector	PK

**Test Figure:**

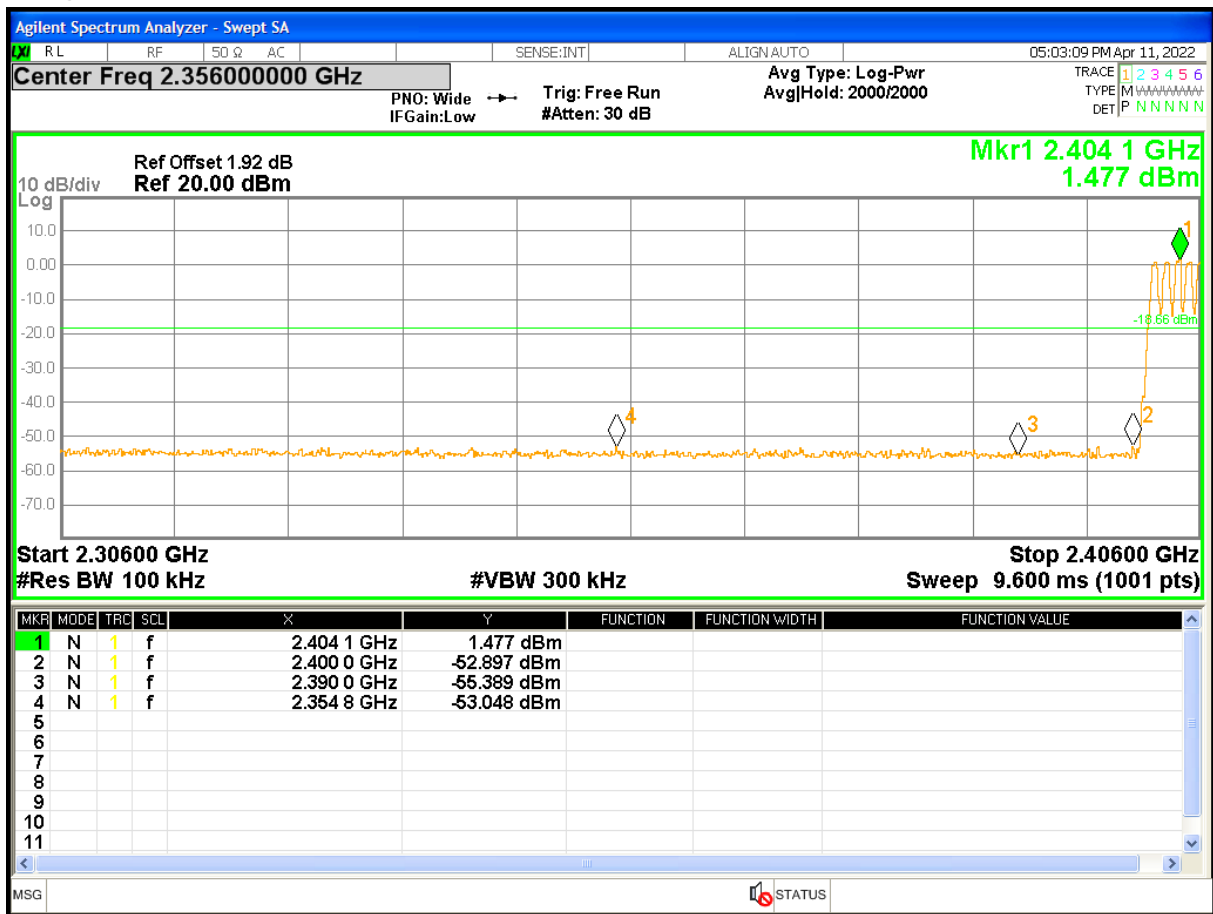

The report refers only to the sample tested and does not apply to the bulk.  
 This report is issued in confidence to the client and it will be strictly treated as such by the SHENZHEN TIMEWAY TESTING LABORATORIES. It may not be reproduced rather in its entirety or in part and it may not be used for advertising. The client to whom the report is issued may, however, show or send it . or a certified copy there of prepared by the SHENZHEN TIMEWAY TESTING LABORATORIES. to his customer. Supplier or others persons directly concerned. SHENZHEN TIMEWAY TESTING LABORATORIES. will not, without the consent of the client enter into any discussion of correspondence with any third party concerning the contents of the report.  
 In the event of the improper use of the report. The SHENZHEN TIMEWAY TESTING LABORATORIES. reserves the rights to withdraw it and to adopt any other remedies which may be appropriate.



**Type of Modulation: GFSK**

**12.4 Band Edge Test Result**

Product:	AIOJET	Test Mode:	Hopping mode
Mode	Hopping On	Input Voltage	120V~
Temperature	24 deg. C,	Humidity	56% RH
Test Result:	Pass	Detector	PK

**Test Figure:**

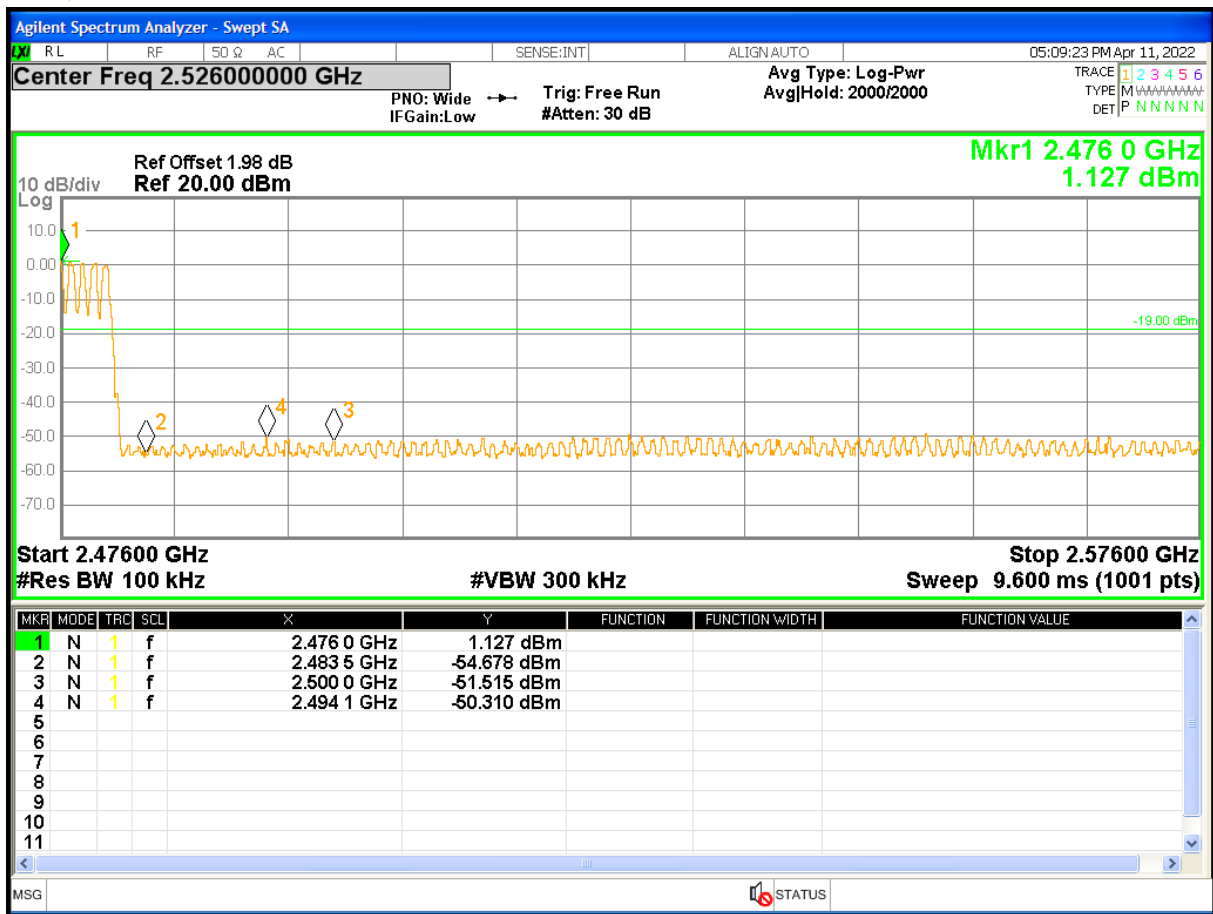

The report refers only to the sample tested and does not apply to the bulk.

This report is issued in confidence to the client and it will be strictly treated as such by the SHENZHEN TIMEWAY TESTING LABORATORIES. It may not be reproduced rather in its entirety or in part and it may not be used for advertising. The client to whom the report is issued may, however, show or send it . or a certified copy there of prepared by the SHENZHEN TIMEWAY TESTING LABORATORIES. to his customer. Supplier or others persons directly concerned. SHENZHEN TIMEWAY TESTING LABORATORIES. will not, without the consent of the client enter into any discussion of correspondence with any third party concerning the contents of the report.

In the event of the improper use of the report. The SHENZHEN TIMEWAY TESTING LABORATORIES. reserves the rights to withdraw it and to adopt any other remedies which may be appropriate.



**Type of Modulation:  $\pi/4$ D-QPSK**

**12.4 Out of Band Test Result**

Product:	AIOJET	Test Mode:	Low Channel
Mode	Keeping Transmitting	Input Voltage	120V~
Temperature	24 deg. C	Humidity	56% RH
Test Result:	Pass	Detector	PK

**Test Figure:**

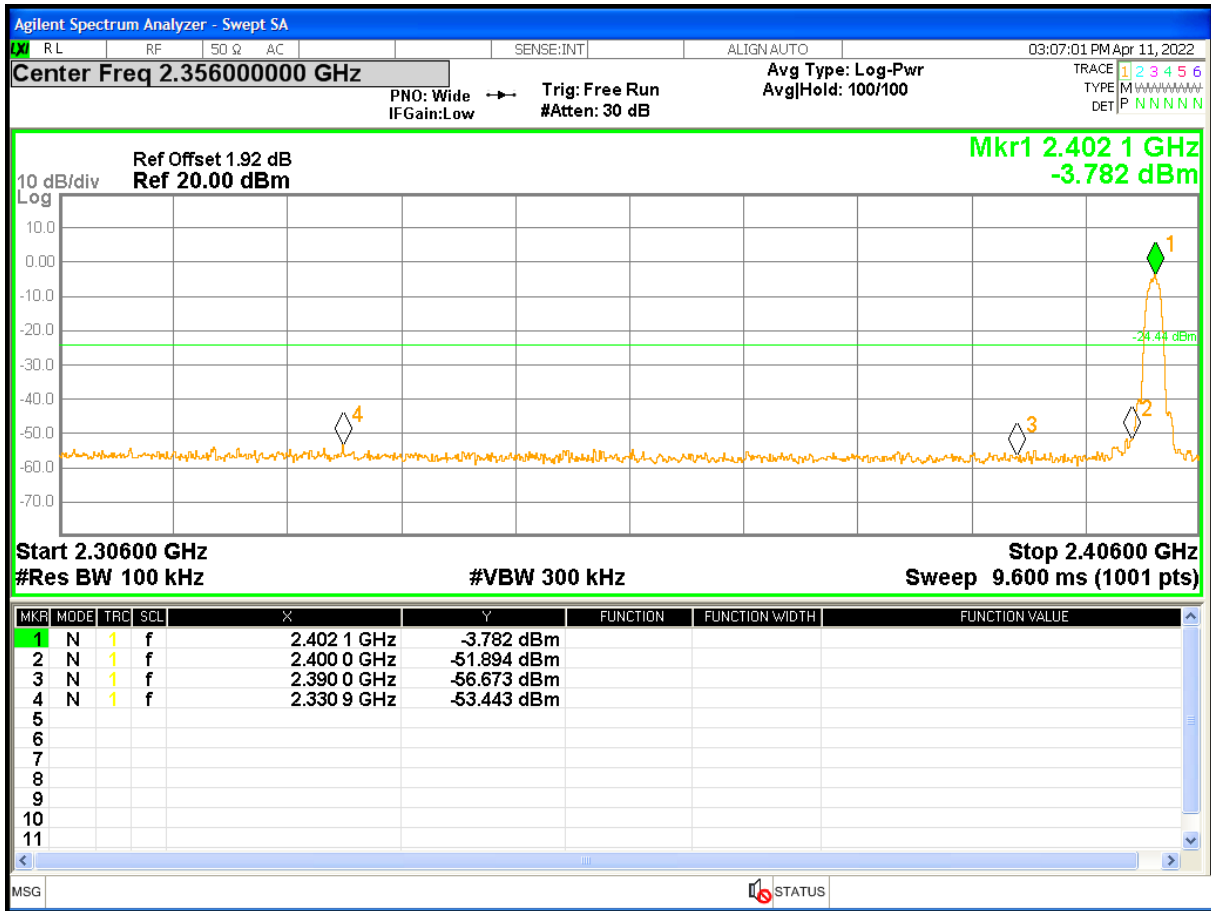

The report refers only to the sample tested and does not apply to the bulk.

This report is issued in confidence to the client and it will be strictly treated as such by the SHENZHEN TIMEWAY TESTING LABORATORIES. It may not be reproduced rather in its entirety or in part and it may not be used for advertising. The client to whom the report is issued may, however, show or send it, or a certified copy thereof prepared by the SHENZHEN TIMEWAY TESTING LABORATORIES, to his customer. Supplier or others persons directly concerned. SHENZHEN TIMEWAY TESTING LABORATORIES, will not, without the consent of the client enter into any discussion of correspondence with any third party concerning the contents of the report.

In the event of the improper use of the report. The SHENZHEN TIMEWAY TESTING LABORATORIES, reserves the rights to withdraw it and to adopt any other remedies which may be appropriate.



**Type of Modulation:  $\pi/4$ D-QPSK**

**12.4 Band Edge Test Result**

Product:	AIOJET	Test Mode:	High Channel
Mode	Keeping Transmitting	Input Voltage	120V~
Temperature	24 deg. C	Humidity	56% RH
Test Result:	Pass	Detector	PK

**Test Figure:**

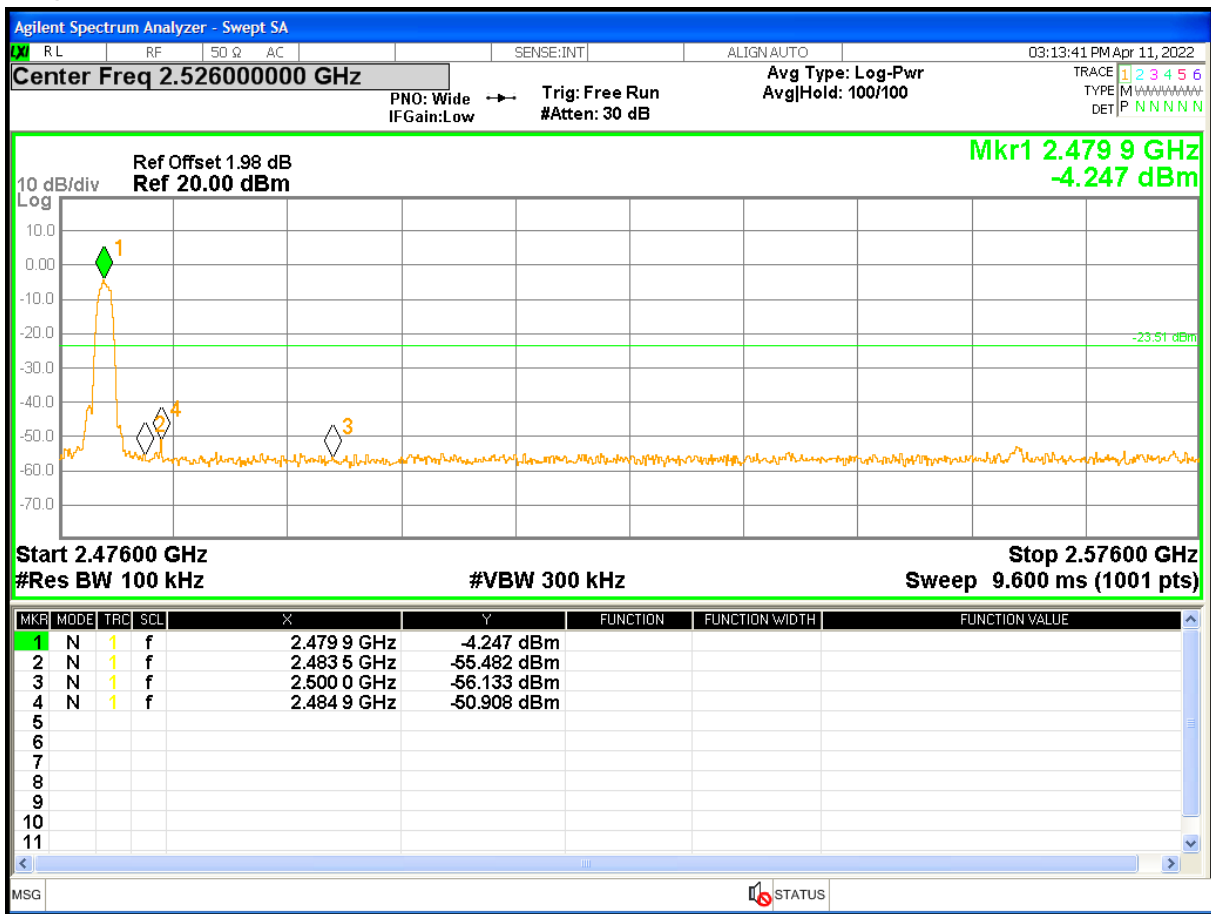

The report refers only to the sample tested and does not apply to the bulk.

This report is issued in confidence to the client and it will be strictly treated as such by the SHENZHEN TIMEWAY TESTING LABORATORIES. It may not be reproduced rather in its entirety or in part and it may not be used for advertng. The client to whom the report is issued may, however, show or send it . or a certified copy there of prepared by the SHENZHEN TIMEWAY TESTING LABORATORIES. to his customer. Supplier or others persons directly concerned. SHENZHEN TIMEWAY TESTING LABORATORIES. will not, without the consent of the client enter into any discussion of correspondence with any third party concerning the contents of the report.

In the event of the improper use of the report. The SHENZHEN TIMEWAY TESTING LABORATORIES. reserves the rights to withdraw it and to adopt any other remedies which may be appropriate.



**Type of Modulation:  $\pi/4$ D-QPSK**

**12.4 Out of Band Test Result**

Product:	AIOJET	Test Mode:	Hopping mode
Mode	Hopping On	Input Voltage	120V~
Temperature	24 deg. C	Humidity	56% RH
Test Result:	Pass	Detector	PK

**Test Figure:**

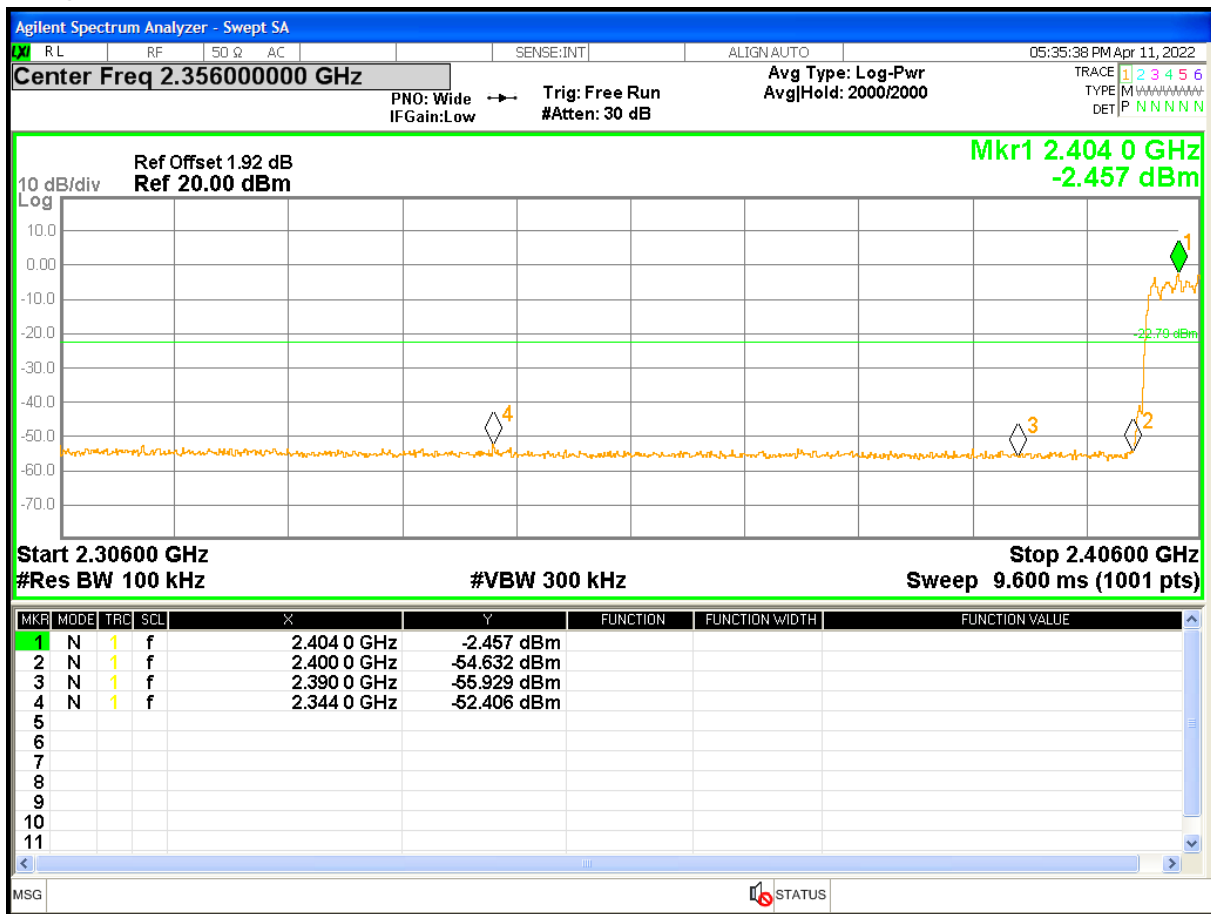

The report refers only to the sample tested and does not apply to the bulk.  
 This report is issued in confidence to the client and it will be strictly treated as such by the SHENZHEN TIMEWAY TESTING LABORATORIES. It may not be reproduced rather in its entirety or in part and it may not be used for advertising. The client to whom the report is issued may, however, show or send it . or a certified copy there of prepared by the SHENZHEN TIMEWAY TESTING LABORATORIES. to his customer. Supplier or others persons directly concerned. SHENZHEN TIMEWAY TESTING LABORATORIES. will not, without the consent of the client enter into any discussion of correspondence with any third party concerning the contents of the report.  
 In the event of the improper use of the report. The SHENZHEN TIMEWAY TESTING LABORATORIES. reserves the rights to withdraw it and to adopt any other remedies which may be appropriate.



**Type of Modulation:  $\pi/4$ D-QPSK**

**12.4 Out of Band Test Result**

Product:	AIOJET	Test Mode:	Hopping mode
Mode	Hopping On	Input Voltage	120V~
Temperature	24 deg. C	Humidity	56% RH
Test Result:	Pass	Detector	PK

**Test Figure:**

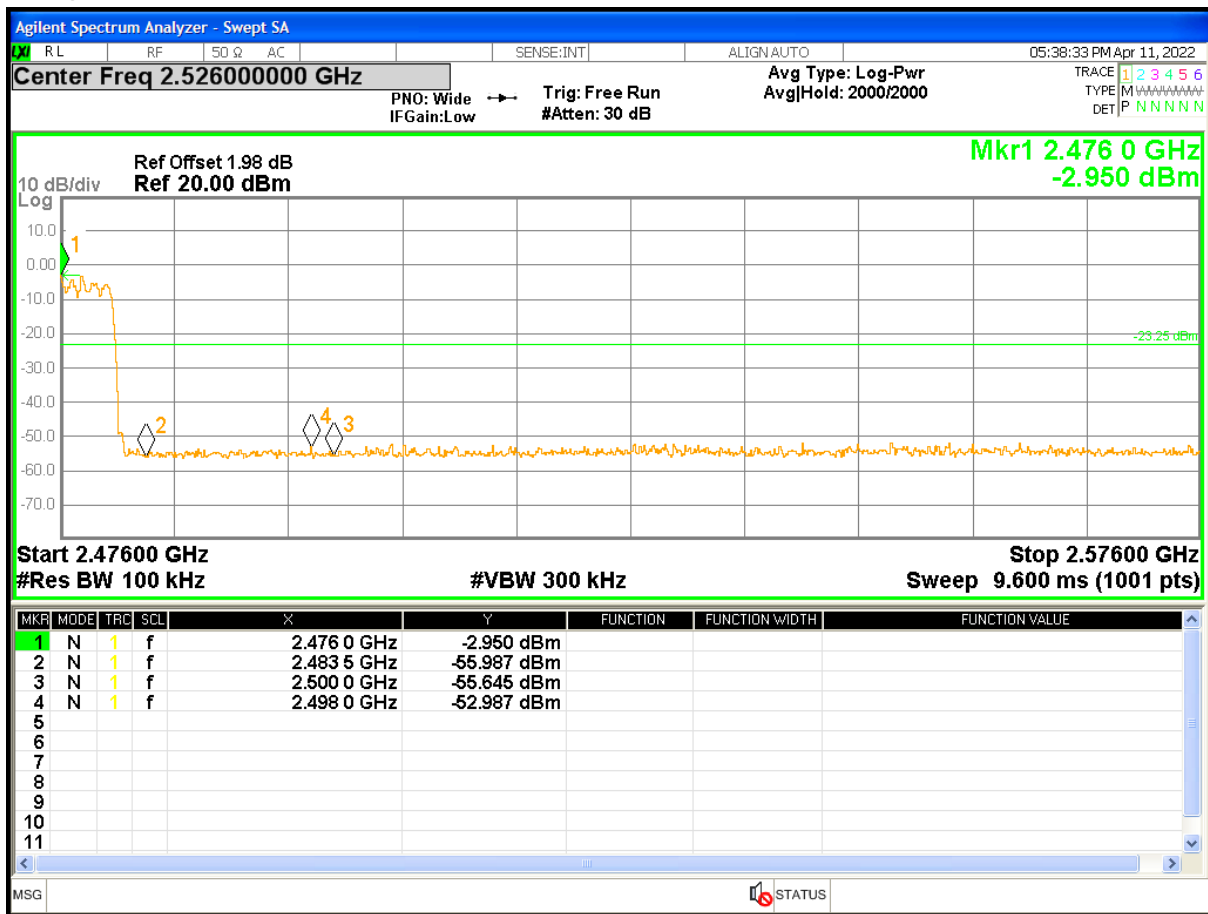

The report refers only to the sample tested and does not apply to the bulk.

This report is issued in confidence to the client and it will be strictly treated as such by the SHENZHEN TIMEWAY TESTING LABORATORIES. It may not be reproduced rather in its entirety or in part and it may not be used for advertising. The client to whom the report is issued may, however, show or send it, or a certified copy thereof prepared by the SHENZHEN TIMEWAY TESTING LABORATORIES, to his customer. Supplier or others persons directly concerned. SHENZHEN TIMEWAY TESTING LABORATORIES, will not, without the consent of the client enter into any discussion of correspondence with any third party concerning the contents of the report.

In the event of the improper use of the report. The SHENZHEN TIMEWAY TESTING LABORATORIES, reserves the rights to withdraw it and to adopt any other remedies which may be appropriate.





**Type of Modulation: 8DPSK**

**12.4 Band Edge Test Result**

Product:	AIOJET	Test Mode:	Low Channel
Mode	Keeping Transmitting	Input Voltage	120V~
Temperature	24 deg. C	Humidity	56% RH
Test Result:	Pass	Detector	PK

**Test Figure:**

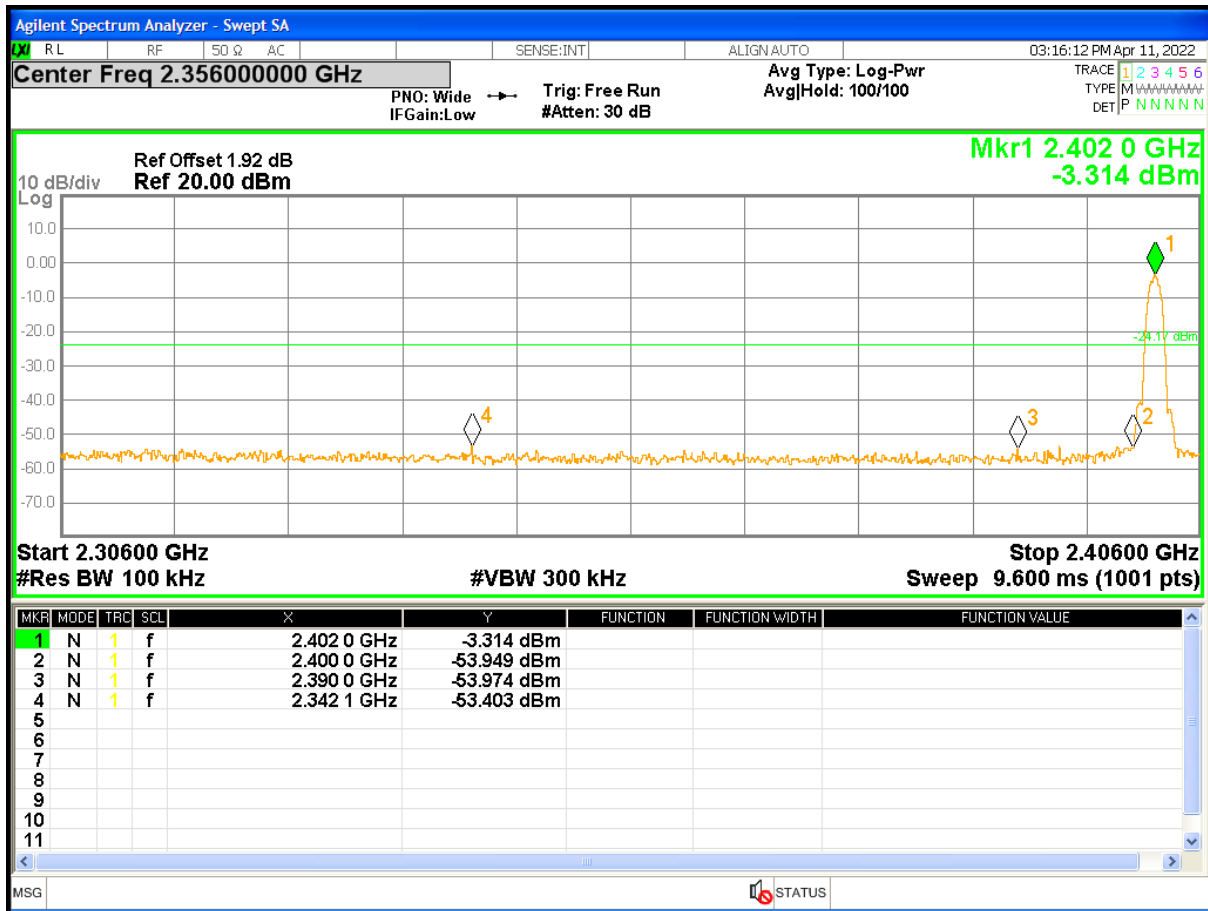

The report refers only to the sample tested and does not apply to the bulk.

This report is issued in confidence to the client and it will be strictly treated as such by the SHENZHEN TIMEWAY TESTING LABORATORIES. It may not be reproduced rather in its entirety or in part and it may not be used for adverting. The client to whom the report is issued may, however, show or send it . or a certified copy there of prepared by the SHENZHEN TIMEWAY TESTING LABORATORIES. to his customer. Supplier or others persons directly concerned. SHENZHEN TIMEWAY TESTING LABORATORIES. will not, without the consent of the client enter into any discussion of correspondence with any third party concerning the contents of the report.

In the event of the improper use of the report. The SHENZHEN TIMEWAY TESTING LABORATORIES. reserves the rights to withdraw it and to adopt any other remedies which may be appropriate.



**Type of Modulation: 8DPSK**

**12.4 Band Edge Test Result**

Product:	AIOJET	Test Mode:	High Channel
Mode	Keeping Transmitting	Input Voltage	120V~
Temperature	24 deg. C	Humidity	56% RH
Test Result:	Pass	Detector	PK

**Test Figure:**

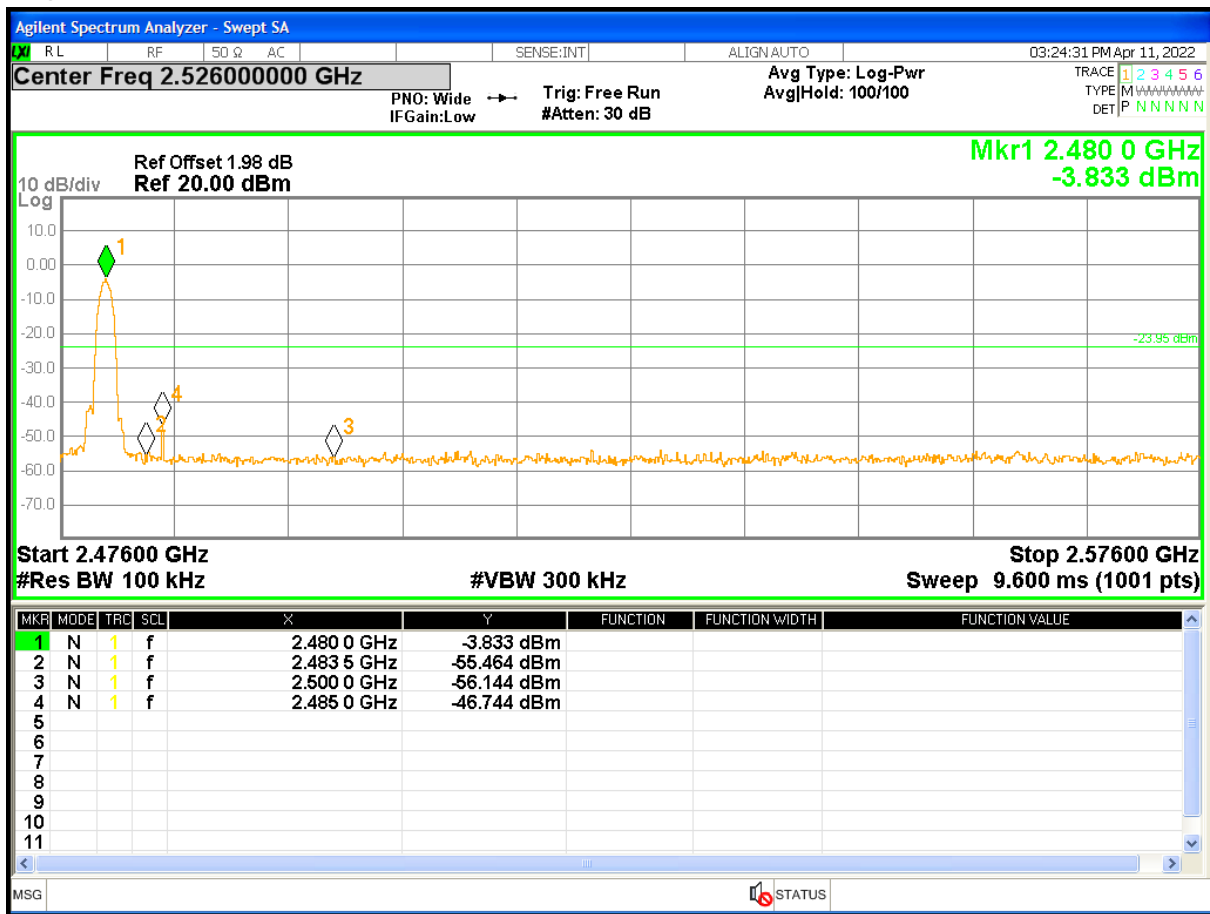

The report refers only to the sample tested and does not apply to the bulk.

This report is issued in confidence to the client and it will be strictly treated as such by the SHENZHEN TIMEWAY TESTING LABORATORIES. It may not be reproduced rather in its entirety or in part and it may not be used for advertising. The client to whom the report is issued may, however, show or send it, or a certified copy thereof prepared by the SHENZHEN TIMEWAY TESTING LABORATORIES, to his customer. Supplier or others persons directly concerned. SHENZHEN TIMEWAY TESTING LABORATORIES, will not, without the consent of the client enter into any discussion of correspondence with any third party concerning the contents of the report.

In the event of the improper use of the report. The SHENZHEN TIMEWAY TESTING LABORATORIES, reserves the rights to withdraw it and to adopt any other remedies which may be appropriate.



**Type of Modulation: 8DPSK**

**12.4 Band Edge Test Result**

Product:	AIOJET	Test Mode:	Hopping mode
Mode	Hopping On	Input Voltage	120V~
Temperature	24 deg. C	Humidity	56% RH
Test Result:	Pass	Detector	PK

**Test Figure:**

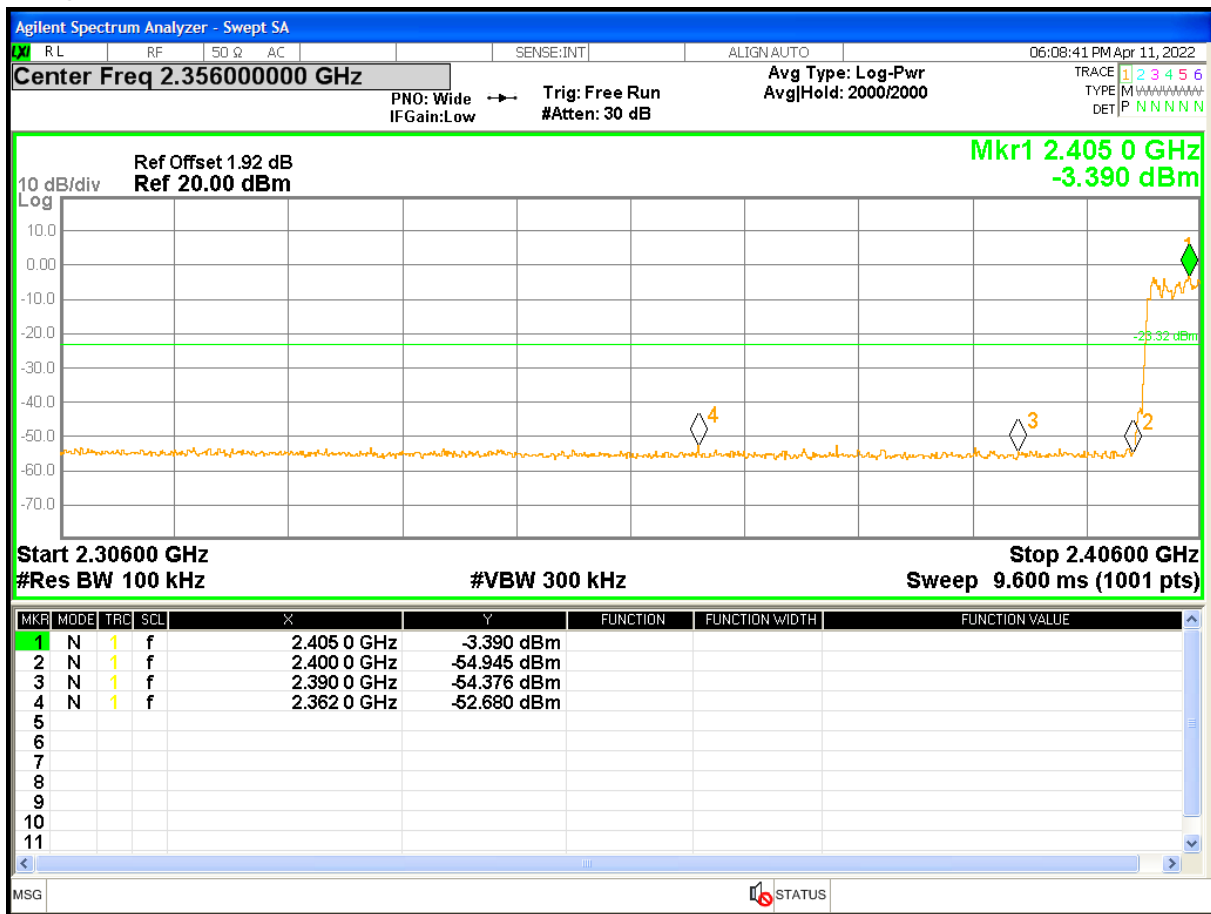

The report refers only to the sample tested and does not apply to the bulk.

This report is issued in confidence to the client and it will be strictly treated as such by the SHENZHEN TIMEWAY TESTING LABORATORIES. It may not be reproduced rather in its entirety or in part and it may not be used for advertising. The client to whom the report is issued may, however, show or send it . or a certified copy there of prepared by the SHENZHEN TIMEWAY TESTING LABORATORIES. to his customer. Supplier or others persons directly concerned. SHENZHEN TIMEWAY TESTING LABORATORIES. will not, without the consent of the client enter into any discussion of correspondence with any third party concerning the contents of the report.

In the event of the improper use of the report. The SHENZHEN TIMEWAY TESTING LABORATORIES. reserves the rights to withdraw it and to adopt any other remedies which may be appropriate.



**Type of Modulation: 8DPSK**

**12.4 Band Edge Test Result**

Product:	AIOJET	Test Mode:	Hopping mode
Mode	Hopping On	Input Voltage	120V~
Temperature	24 deg. C	Humidity	56% RH
Test Result:	Pass	Detector	PK

**Test Figure:**

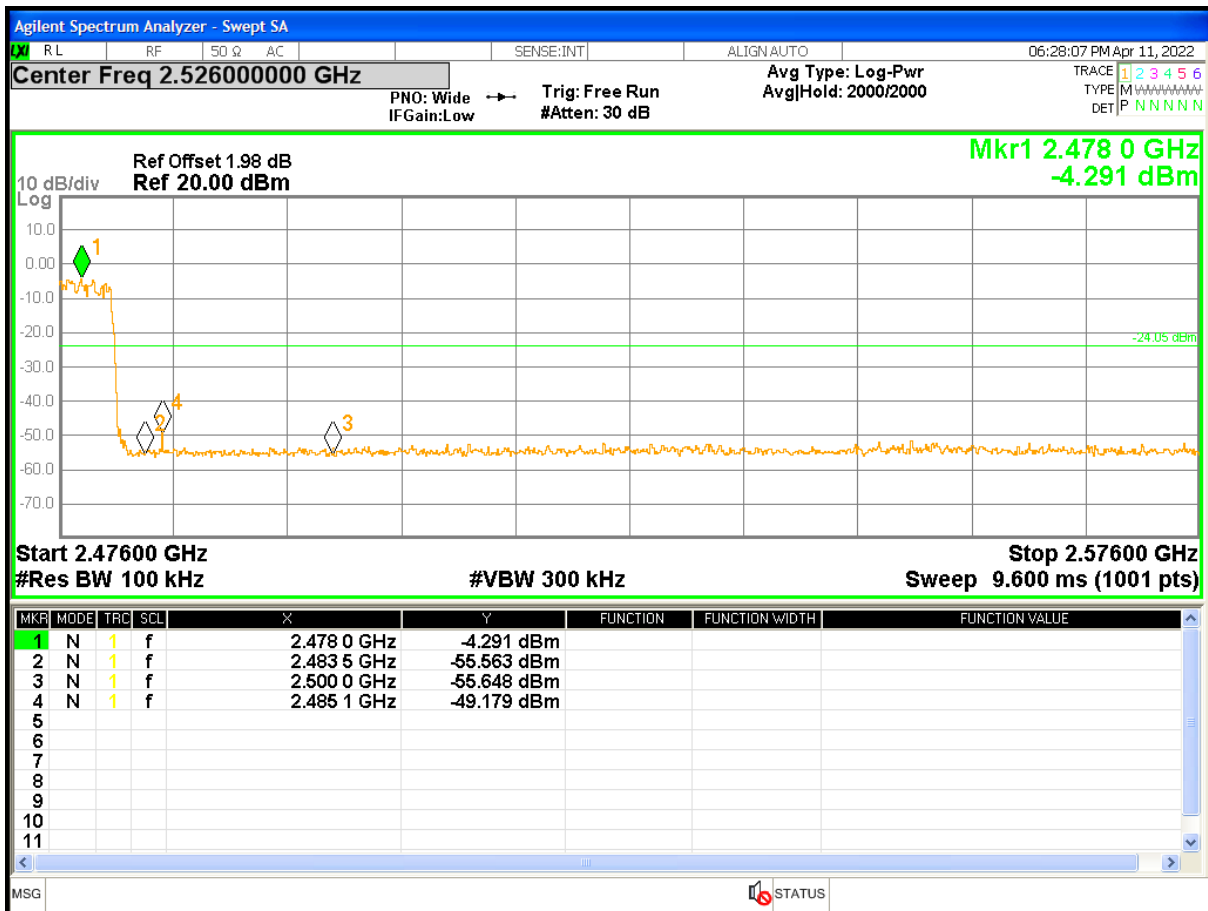

The report refers only to the sample tested and does not apply to the bulk.

This report is issued in confidence to the client and it will be strictly treated as such by the SHENZHEN TIMEWAY TESTING LABORATORIES. It may not be reproduced rather in its entirety or in part and it may not be used for adverting. The client to whom the report is issued may, however, show or send it . or a certified copy there of prepared by the SHENZHEN TIMEWAY TESTING LABORATORIES. to his customer. Supplier or others persons directly concerned. SHENZHEN TIMEWAY TESTING LABORATORIES. will not, without the consent of the client enter into any discussion of correspondence with any third party concerning the contents of the report.

In the event of the improper use of the report. The SHENZHEN TIMEWAY TESTING LABORATORIES. reserves the rights to withdraw it and to adopt any other remedies which may be appropriate.



**12.4 Restricted band Measurement**

EUT	AIOJET		Model	AIOJet G1P
Mode	Keep Transmitting		Input Voltage	120V~
Temperature	24 deg. C,		Humidity	56% RH
Test Result:	Pass		Detector	PK
Low Channel, Horizontal				
2390	PK (dB $\mu$ V/m)	43.32	Limit	74(dB $\mu$ V/m)
	AV (dB $\mu$ V/m)	--		54(dB $\mu$ V/m)
Low Channel, Vertical				
2390	PK (dB $\mu$ V/m)	42.19	Limit	74(dB $\mu$ V/m)
	AV (dB $\mu$ V/m)	--		54(dB $\mu$ V/m)

**12.4 Restricted band Measurement**

EUT	AIOJET		Model	AIOJet G1P
Mode	Keep Transmitting		Input Voltage	120V~
Temperature	24 deg. C,		Humidity	56% RH
Test Result:	Pass		Detector	PK
High Channel, Horizontal				
2483.5	PK (dB $\mu$ V/m)	52.68	Limit	74(dB $\mu$ V/m)
	AV (dB $\mu$ V/m)	--		54(dB $\mu$ V/m)
High Channel, Vertical				
2483.5	PK (dB $\mu$ V/m)	50.08	Limit	74(dB $\mu$ V/m)
	AV (dB $\mu$ V/m)	--		54(dB $\mu$ V/m)

Note: 1. For Restricted band test, All modulation mode was tested and only the worst case was reported. GFSK was the worst case.

2. The measured PK value less than the AV limit, no necessary to take down the AV measurement result.

The report refers only to the sample tested and does not apply to the bulk.  
 This report is issued in confidence to the client and it will be strictly treated as such by the SHENZHEN TIMEWAY TESTING LABORATORIES. It may not be reproduced rather in its entirety or in part and it may not be used for adverting. The client to whom the report is issued may, however, show or send it . or a certified copy there of prepared by the SHENZHEN TIMEWAY TESTING LABORATORIES. to his customer. Supplier or others persons directly concerned. SHENZHEN TIMEWAY TESTING LABORATORIES. will not, without the consent of the client enter into any discussion of correspondence with any third party concerning the contents of the report.  
 In the event of the improper use of the report. The SHENZHEN TIMEWAY TESTING LABORATORIES. reserves the rights to withdraw it and to adopt any other remedies which may be appropriate.



## 13.0 Antenna Requirement

### 13.1 Standard Applicable

For intentional device, according to FCC 47 CFR Section 15.203, an intentional radiator shall be designed to ensure that no antenna other than that furnished by the responsible party shall be used with the device.

And according to FCC 47 CFR Section 15.247 (b), if transmitter antennas of directional gain greater than 6 dBi are used, the power shall be reduced by the amount in dB that the directional gain of the antenna exceeds 6 dBi.

### 13.2 Antenna Connected constructions

Male IPEX connector with PCB antenna (Gain: 2.0dBi Maximum)

The report refers only to the sample tested and does not apply to the bulk.

This report is issued in confidence to the client and it will be strictly treated as such by the SHENZHEN TIMEWAY TESTING LABORATORIES. It may not be reproduced in its entirety or in part and it may not be used for advertising. The client to whom the report is issued may, however, show or send it or a certified copy thereof prepared by the SHENZHEN TIMEWAY TESTING LABORATORIES to his customer. Supplier or other persons directly concerned. SHENZHEN TIMEWAY TESTING LABORATORIES will not, without the consent of the client enter into any discussion of correspondence with any third party concerning the contents of the report.

In the event of the improper use of the report. The SHENZHEN TIMEWAY TESTING LABORATORIES reserves the rights to withdraw it and to adopt any other remedies which may be appropriate.



#### 14.0 FCC ID Label

##### FCC ID: 2A3BL-AIOJETG1P

This device complies with Part 15 of the FCC Rules. Operation is subject to the following two conditions: (1) this device may not cause harmful interference, and (2) this device must accept any interference received, including interference that may cause undesired operation

The label must not be a stick-on paper label. The label on these products must be permanently affixed to the product and readily visible at the time of purchase and must last the expected lifetime of the equipment not be readily detachable.

##### Mark Location:



The report refers only to the sample tested and does not apply to the bulk.

This report is issued in confidence to the client and it will be strictly treated as such by the SHENZHEN TIMEWAY TESTING LABORATORIES. It may not be reproduced rather in its entirety or in part and it may not be used for advertising. The client to whom the report is issued may, however, show or send it or a certified copy thereof prepared by the SHENZHEN TIMEWAY TESTING LABORATORIES to his customer. Supplier or others persons directly concerned. SHENZHEN TIMEWAY TESTING LABORATORIES will not, without the consent of the client enter into any discussion of correspondence with any third party concerning the contents of the report.

In the event of the improper use of the report. The SHENZHEN TIMEWAY TESTING LABORATORIES reserves the rights to withdraw it and to adopt any other remedies which may be appropriate.



### 15.0 Photo of testing

Conducted Emission Test Setup:



The report refers only to the sample tested and does not apply to the bulk.

This report is issued in confidence to the client and it will be strictly treated as such by the SHENZHEN TIMEWAY TESTING LABORATORIES. It may not be reproduced rather in its entirety or in part and it may not be used for adverting. The client to whom the report is issued may, however, show or send it . or a certified copy there of prepared by the SHENZHEN TIMEWAY TESTING LABORATORIES. to his customer. Supplier or others persons directly concerned. SHENZHEN TIMEWAY TESTING LABORATORIES. will not, without the consent of the client enter into any discussion of correspondence with any third party concerning the contents of the report.

In the event of the improper use of the report. The SHENZHEN TIMEWAY TESTING LABORATORIES. reserves the rights to withdraw it and to adopt any other remedies which may be appropriate.





Radiated Emission Test Setup:



The report refers only to the sample tested and does not apply to the bulk.

This report is issued in confidence to the client and it will be strictly treated as such by the SHENZHEN TIMEWAY TESTING LABORATORIES. It may not be reproduced rather in its entirety or in part and it may not be used for advertising. The client to whom the report is issued may, however, show or send it, or a certified copy thereof prepared by the SHENZHEN TIMEWAY TESTING LABORATORIES, to his customer. Supplier or others persons directly concerned. SHENZHEN TIMEWAY TESTING LABORATORIES, will not, without the consent of the client enter into any discussion of correspondence with any third party concerning the contents of the report. In the event of the improper use of the report. The SHENZHEN TIMEWAY TESTING LABORATORIES, reserves the rights to withdraw it and to adopt any other remedies which may be appropriate.

Photo for the EUT

Outside View



The report refers only to the sample tested and does not apply to the bulk.

This report is issued in confidence to the client and it will be strictly treated as such by the SHENZHEN TIMEWAY TESTING LABORATORIES. It may not be reproduced rather in its entirety or in part and it may not be used for advertising. The client to whom the report is issued may, however, show or send it . or a certified copy there of prepared by the SHENZHEN TIMEWAY TESTING LABORATORIES. to his customer. Supplier or others persons directly concerned. SHENZHEN TIMEWAY TESTING LABORATORIES. will not, without the consent of the client enter into any discussion of correspondence with any third party concerning the contents of the report. In the event of the improper use of the report. The SHENZHEN TIMEWAY TESTING LABORATORIES. reserves the rights to withdraw it and to adopt any other remedies which may be appropriate.



Outside View



The report refers only to the sample tested and does not apply to the bulk.  
This report is issued in confidence to the client and it will be strictly treated as such by the SHENZHEN TIMEWAY TESTING LABORATORIES. It may not be reproduced rather in its entirety or in part and it may not be used for advertising. The client to whom the report is issued may, however, show or send it . or a certified copy there of prepared by the SHENZHEN TIMEWAY TESTING LABORATORIES. to his customer. Supplier or others persons directly concerned. SHENZHEN TIMEWAY TESTING LABORATORIES. will not, without the consent of the client enter into any discussion of correspondence with any third party concerning the contents of the report.  
In the event of the improper use of the report. The SHENZHEN TIMEWAY TESTING LABORATORIES. reserves the rights to withdraw it and to adopt any other remedies which may be appropriate.



Outside View



The report refers only to the sample tested and does not apply to the bulk.  
This report is issued in confidence to the client and it will be strictly treated as such by the SHENZHEN TIMEWAY TESTING LABORATORIES. It may not be reproduced rather in its entirety or in part and it may not be used for adverting. The client to whom the report is issued may, however, show or send it . or a certified copy there of prepared by the SHENZHEN TIMEWAY TESTING LABORATORIES. to his customer. Supplier or others persons directly concerned. SHENZHEN TIMEWAY TESTING LABORATORIES. will not, without the consent of the client enter into any discussion of correspondence with any third party concerning the contents of the report.  
In the event of the improper use of the report. The SHENZHEN TIMEWAY TESTING LABORATORIES. reserves the rights to withdraw it and to adopt any other remedies which may be appropriate.



Outside View



The report refers only to the sample tested and does not apply to the bulk.

This report is issued in confidence to the client and it will be strictly treated as such by the SHENZHEN TIMEWAY TESTING LABORATORIES. It may not be reproduced rather in its entirety or in part and it may not be used for advertising. The client to whom the report is issued may, however, show or send it, or a certified copy thereof prepared by the SHENZHEN TIMEWAY TESTING LABORATORIES, to his customer. Supplier or others persons directly concerned. SHENZHEN TIMEWAY TESTING LABORATORIES, will not, without the consent of the client enter into any discussion of correspondence with any third party concerning the contents of the report. In the event of the improper use of the report. The SHENZHEN TIMEWAY TESTING LABORATORIES, reserves the rights to withdraw it and to adopt any other remedies which may be appropriate.



Outside View



The report refers only to the sample tested and does not apply to the bulk.

This report is issued in confidence to the client and it will be strictly treated as such by the SHENZHEN TIMEWAY TESTING LABORATORIES. It may not be reproduced rather in its entirety or in part and it may not be used for advertising. The client to whom the report is issued may, however, show or send it . or a certified copy there of prepared by the SHENZHEN TIMEWAY TESTING LABORATORIES. to his customer. Supplier or others persons directly concerned. SHENZHEN TIMEWAY TESTING LABORATORIES. will not, without the consent of the client enter into any discussion of correspondence with any third party concerning the contents of the report.

In the event of the improper use of the report. The SHENZHEN TIMEWAY TESTING LABORATORIES. reserves the rights to withdraw it and to adopt any other remedies which may be appropriate.



Inside view

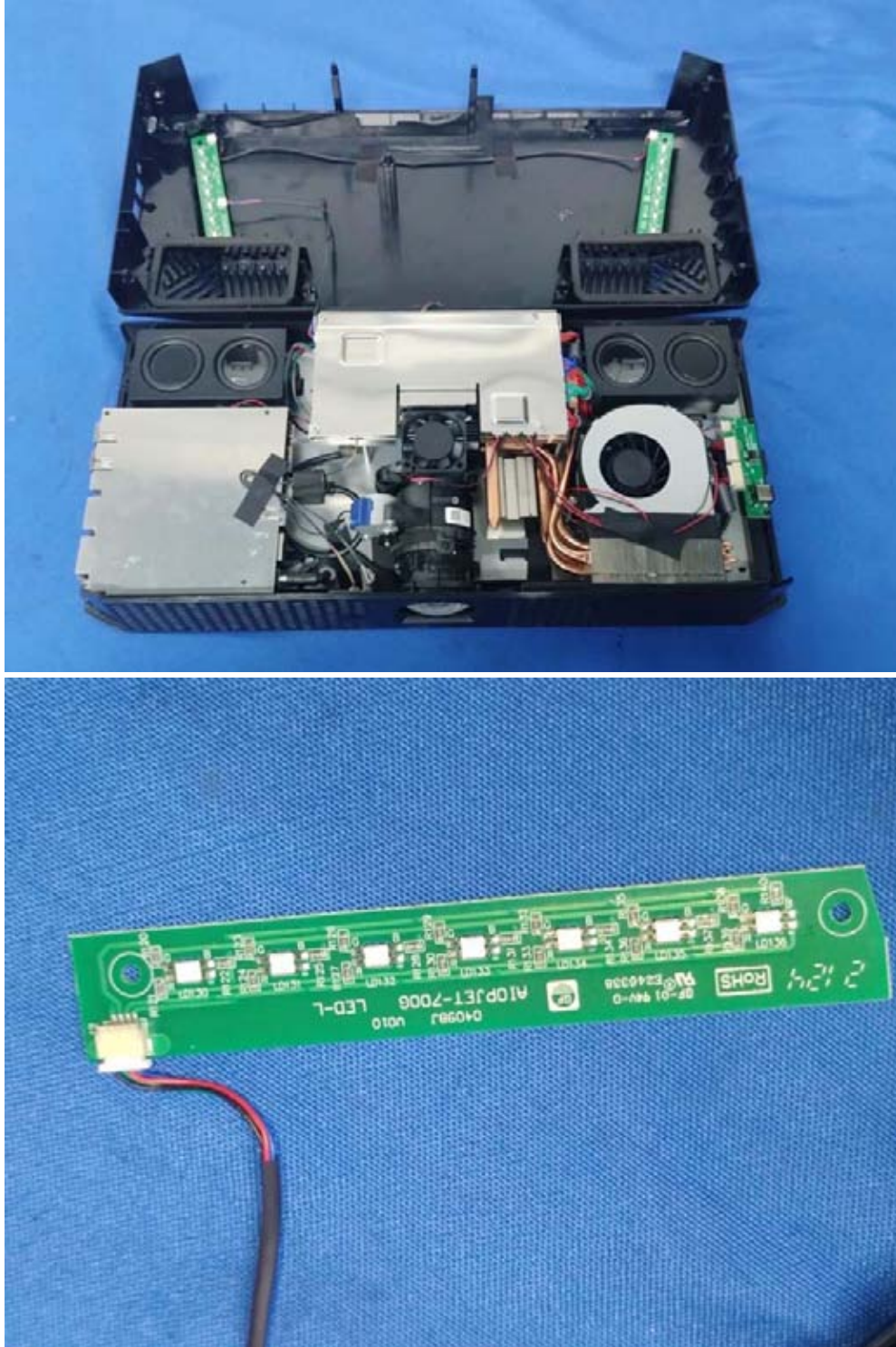

The report refers only to the sample tested and does not apply to the bulk.  
This report is issued in confidence to the client and it will be strictly treated as such by the SHENZHEN TIMEWAY TESTING LABORATORIES. It may not be reproduced rather in its entirety or in part and it may not be used for adverting. The client to whom the report is issued may, however, show or send it . or a certified copy there of prepared by the SHENZHEN TIMEWAY TESTING LABORATORIES. to his customer. Supplier or others persons directly concerned. SHENZHEN TIMEWAY TESTING LABORATORIES. will not, without the consent of the client enter into any discussion of correspondence with any third party concerning the contents of the report.  
In the event of the improper use of the report. The SHENZHEN TIMEWAY TESTING LABORATORIES. reserves the rights to withdraw it and to adopt any other remedies which may be appropriate.



Inside view

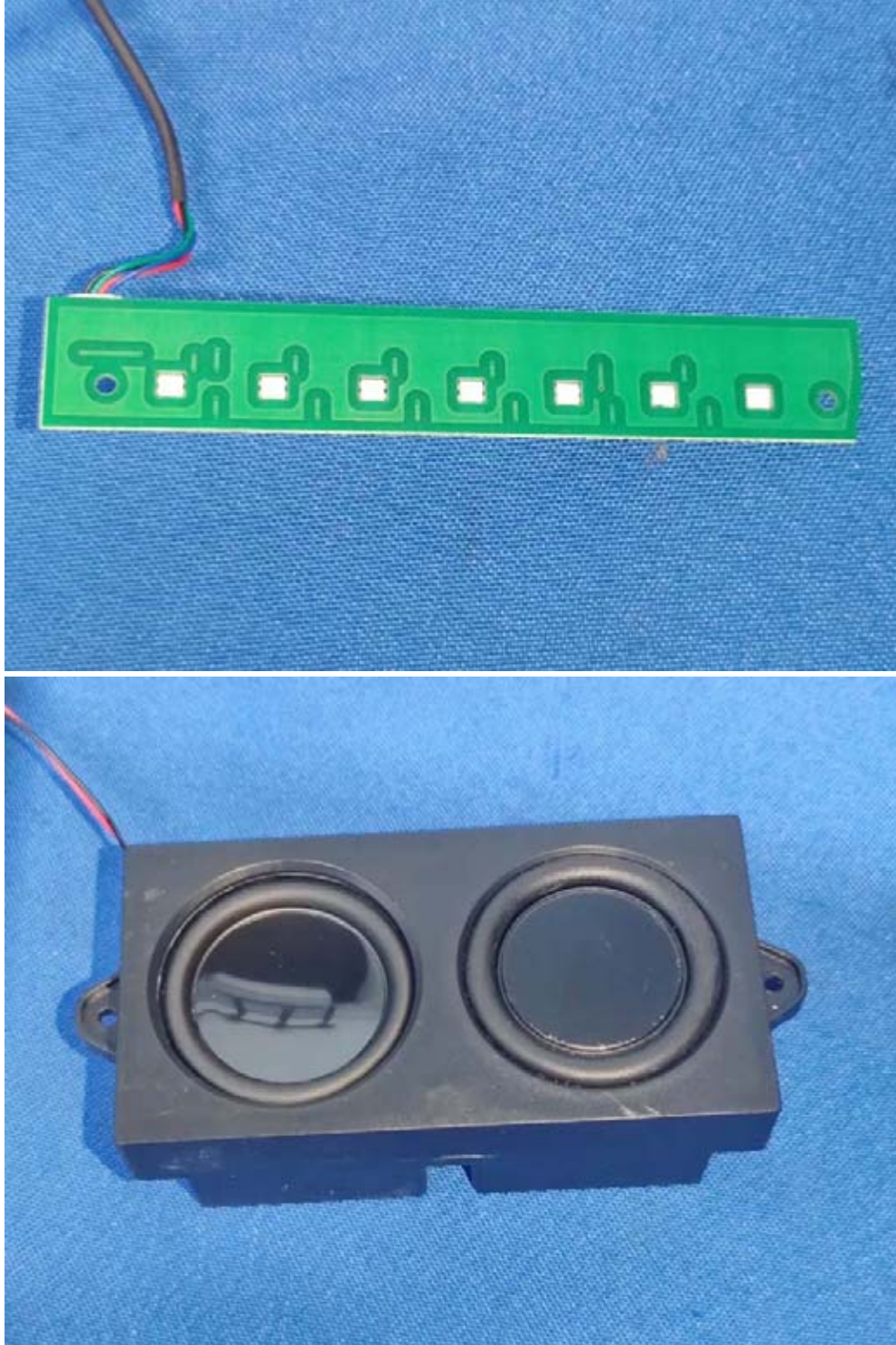

The report refers only to the sample tested and does not apply to the bulk.

This report is issued in confidence to the client and it will be strictly treated as such by the SHENZHEN TIMEWAY TESTING LABORATORIES. It may not be reproduced rather in its entirety or in part and it may not be used for advertizing. The client to whom the report is issued may, however, show or send it . or a certified copy there of prepared by the SHENZHEN TIMEWAY TESTING LABORATORIES. to his customer. Supplier or others persons directly concerned. SHENZHEN TIMEWAY TESTING LABORATORIES. will not, without the consent of the client enter into any discussion of correspondence with any third party concerning the contents of the report. In the event of the improper use of the report. The SHENZHEN TIMEWAY TESTING LABORATORIES. reserves the rights to withdraw it and to adopt any other remedies which may be appropriate.





Inside view

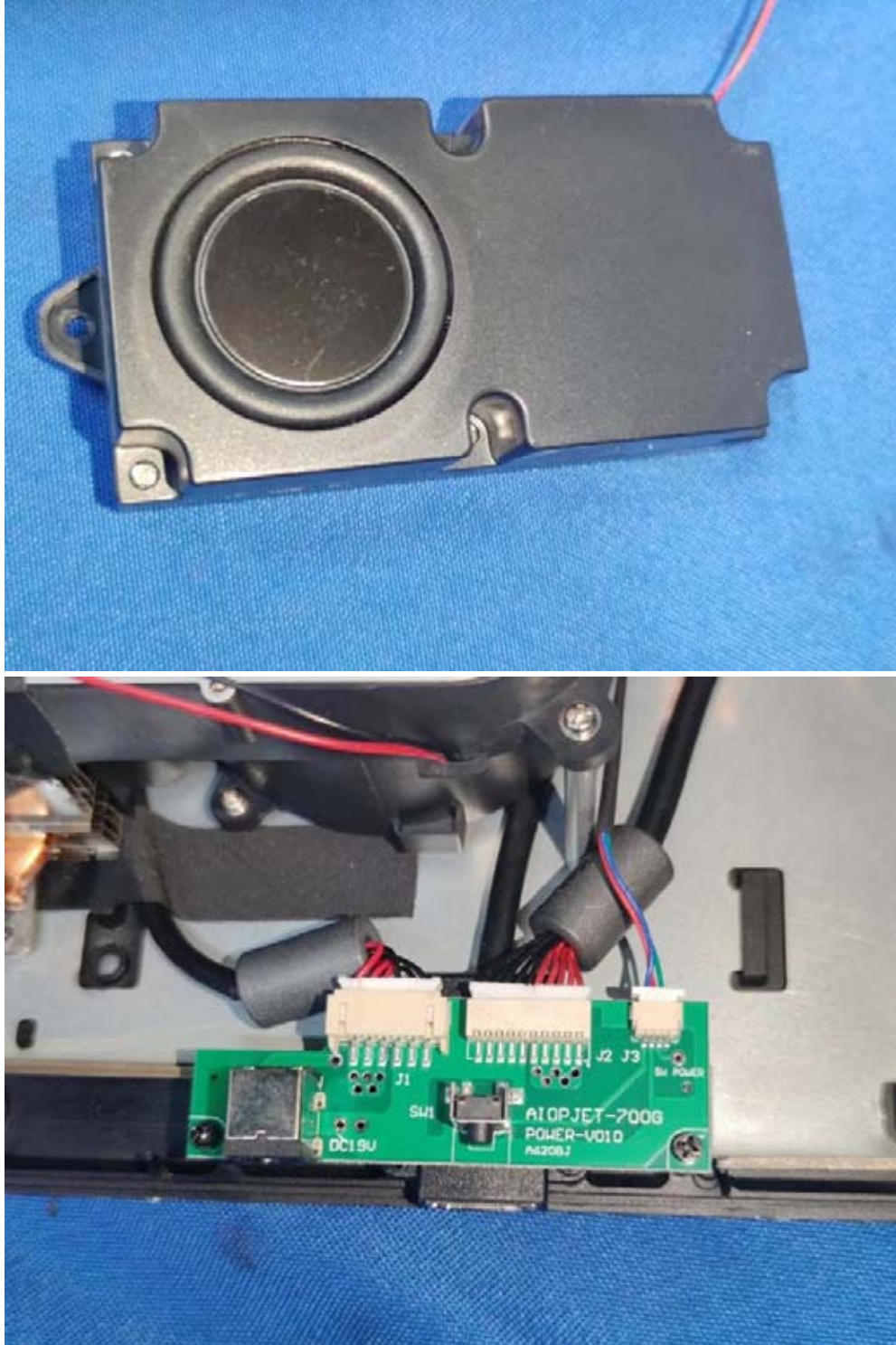

The report refers only to the sample tested and does not apply to the bulk.

This report is issued in confidence to the client and it will be strictly treated as such by the SHENZHEN TIMEWAY TESTING LABORATORIES. It may not be reproduced rather in its entirety or in part and it may not be used for advertising. The client to whom the report is issued may, however, show or send it, or a certified copy thereof prepared by the SHENZHEN TIMEWAY TESTING LABORATORIES, to his customer. Supplier or others persons directly concerned. SHENZHEN TIMEWAY TESTING LABORATORIES, will not, without the consent of the client enter into any discussion of correspondence with any third party concerning the contents of the report.

In the event of the improper use of the report. The SHENZHEN TIMEWAY TESTING LABORATORIES, reserves the rights to withdraw it and to adopt any other remedies which may be appropriate.

Inside view



The report refers only to the sample tested and does not apply to the bulk.

This report is issued in confidence to the client and it will be strictly treated as such by the SHENZHEN TIMEWAY TESTING LABORATORIES. It may not be reproduced rather in its entirety or in part and it may not be used for advertising. The client to whom the report is issued may, however, show or send it, or a certified copy thereof prepared by the SHENZHEN TIMEWAY TESTING LABORATORIES, to his customer. Supplier or others persons directly concerned. SHENZHEN TIMEWAY TESTING LABORATORIES, will not, without the consent of the client enter into any discussion of correspondence with any third party concerning the contents of the report.

In the event of the improper use of the report. The SHENZHEN TIMEWAY TESTING LABORATORIES, reserves the rights to withdraw it and to adopt any other remedies which may be appropriate.



Inside view

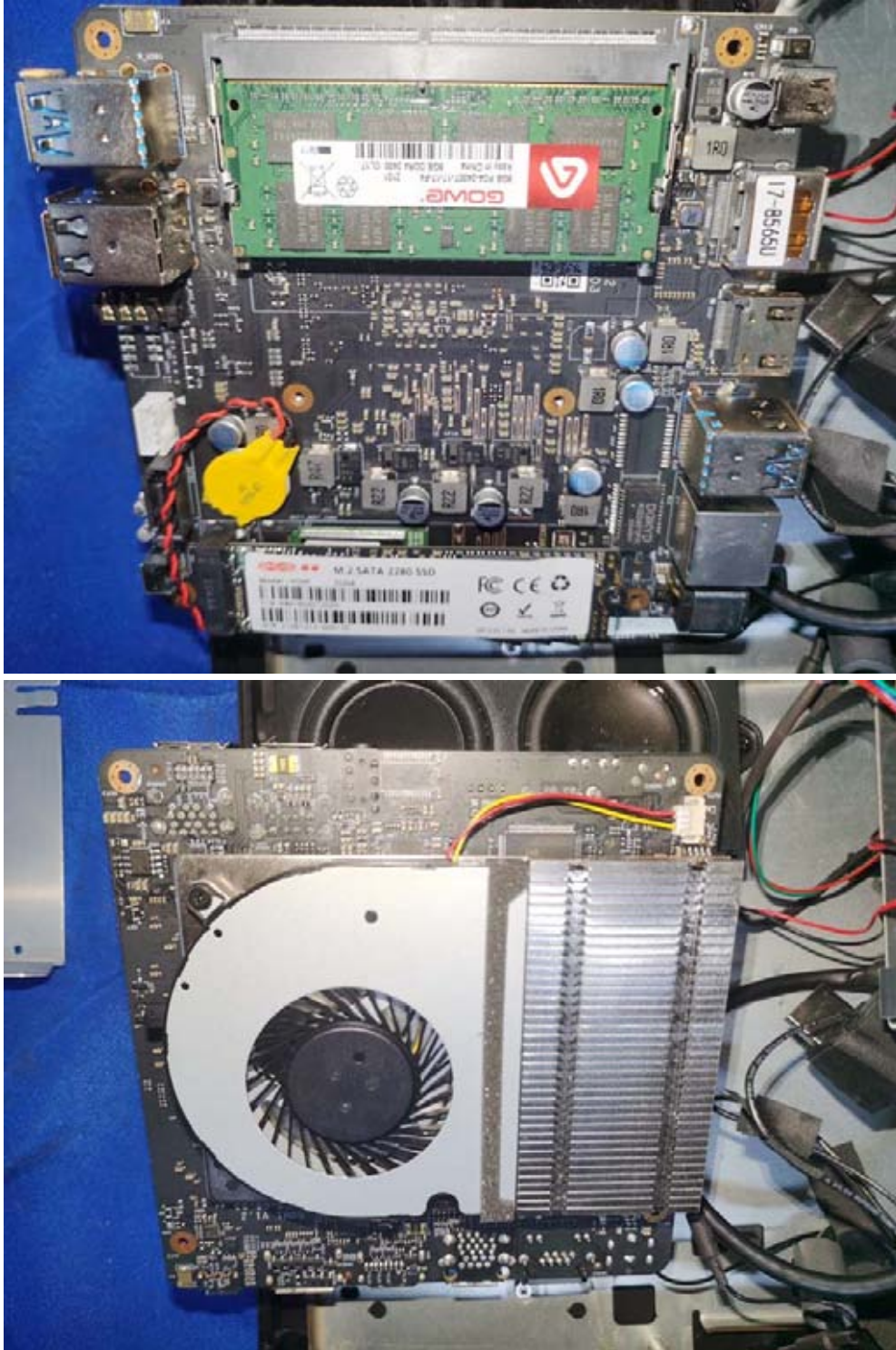

The report refers only to the sample tested and does not apply to the bulk.

This report is issued in confidence to the client and it will be strictly treated as such by the SHENZHEN TIMEWAY TESTING LABORATORIES. It may not be reproduced rather in its entirety or in part and it may not be used for advertising. The client to whom the report is issued may, however, show or send it . or a certified copy there of prepared by the SHENZHEN TIMEWAY TESTING LABORATORIES. to his customer. Supplier or others persons directly concerned. SHENZHEN TIMEWAY TESTING LABORATORIES. will not, without the consent of the client enter into any discussion of correspondence with any third party concerning the contents of the report. In the event of the improper use of the report. The SHENZHEN TIMEWAY TESTING LABORATORIES. reserves the rights to withdraw it and to adopt any other remedies which may be appropriate.



Inside view

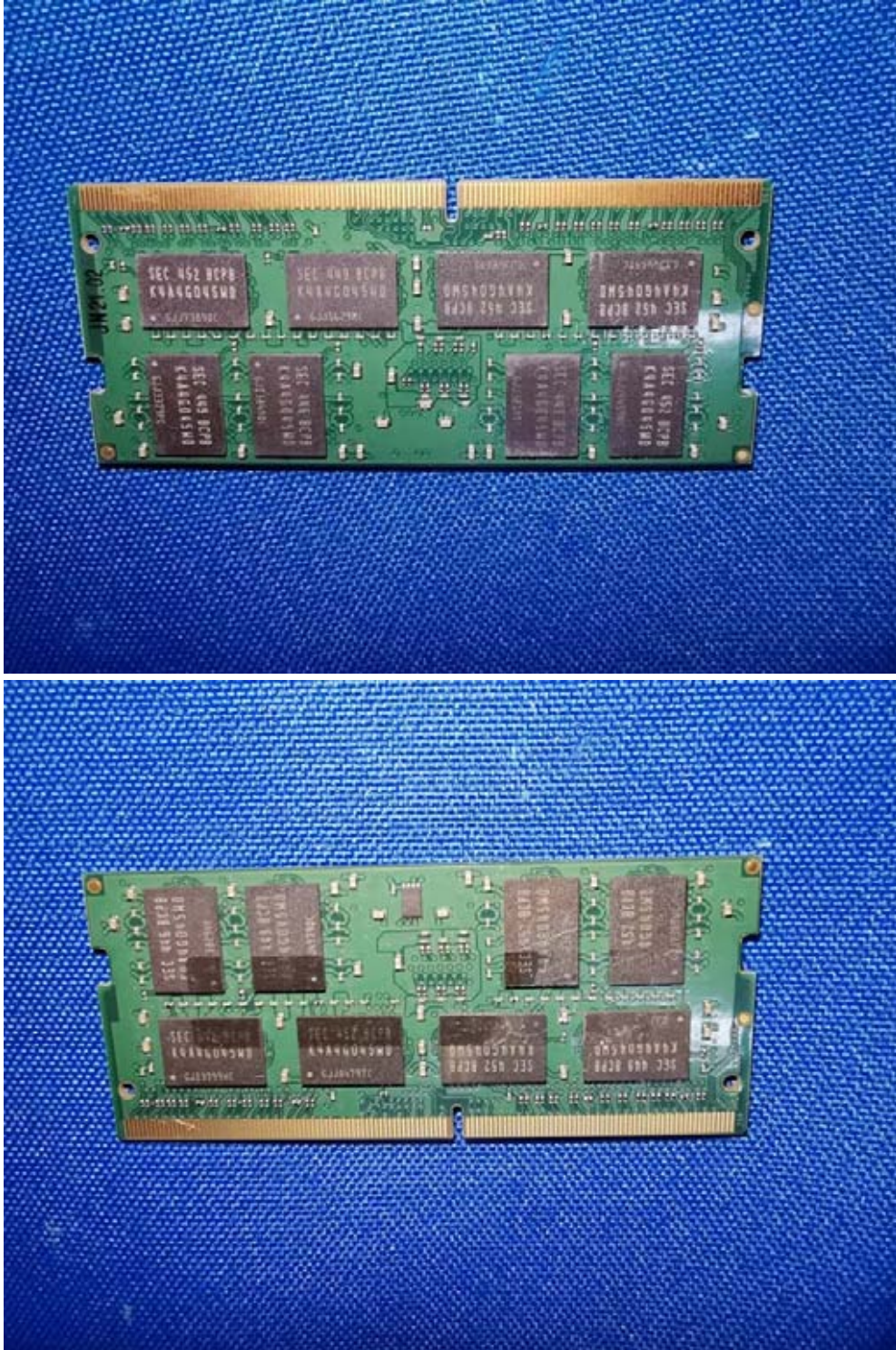

The report refers only to the sample tested and does not apply to the bulk.

This report is issued in confidence to the client and it will be strictly treated as such by the SHENZHEN TIMEWAY TESTING LABORATORIES. It may not be reproduced rather in its entirety or in part and it may not be used for advertising. The client to whom the report is issued may, however, show or send it, or a certified copy thereof prepared by the SHENZHEN TIMEWAY TESTING LABORATORIES, to his customer. Supplier or others persons directly concerned. SHENZHEN TIMEWAY TESTING LABORATORIES, will not, without the consent of the client enter into any discussion of correspondence with any third party concerning the contents of the report.

In the event of the improper use of the report. The SHENZHEN TIMEWAY TESTING LABORATORIES, reserves the rights to withdraw it and to adopt any other remedies which may be appropriate.



Inside view

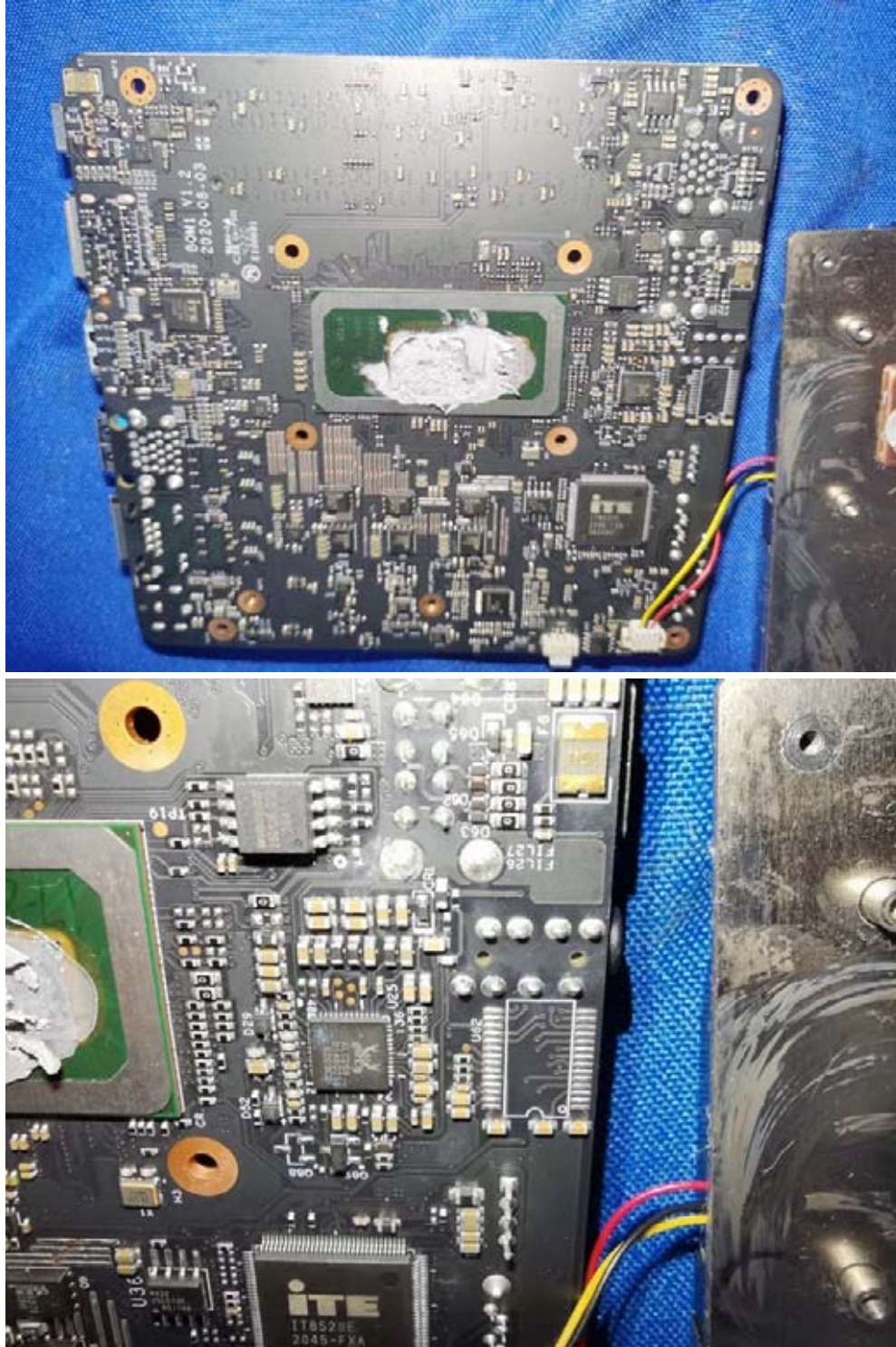

The report refers only to the sample tested and does not apply to the bulk.  
This report is issued in confidence to the client and it will be strictly treated as such by the SHENZHEN TIMEWAY TESTING LABORATORIES. It may not be reproduced rather in its entirety or in part and it may not be used for advertising. The client to whom the report is issued may, however, show or send it, or a certified copy thereof, to his customer. Supplier or others persons directly concerned. SHENZHEN TIMEWAY TESTING LABORATORIES. will not, without the consent of the client enter into any discussion of correspondence with any third party concerning the contents of the report.  
In the event of the improper use of the report. The SHENZHEN TIMEWAY TESTING LABORATORIES. reserves the rights to withdraw it and to adopt any other remedies which may be appropriate.



Inside view

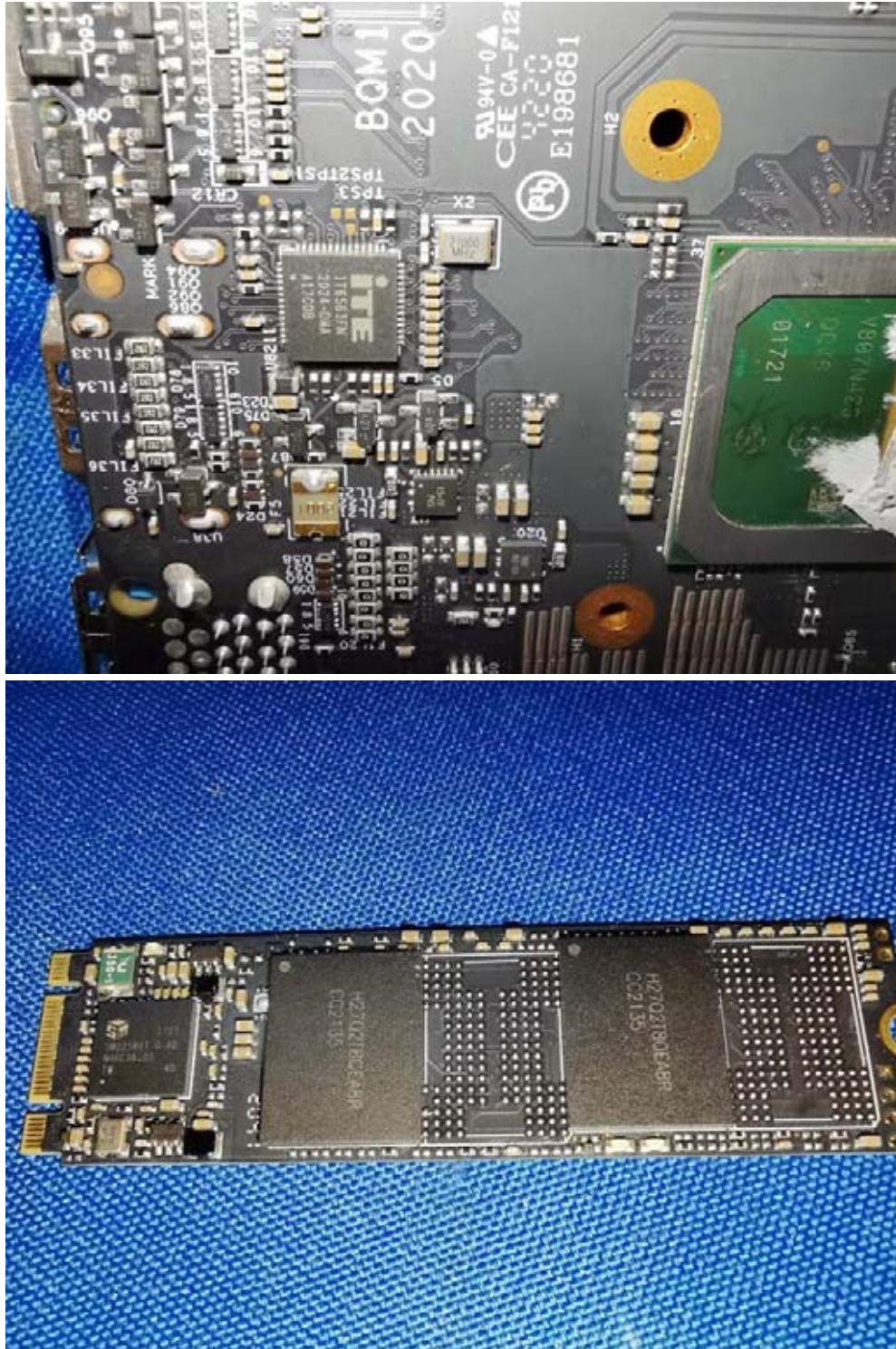

The report refers only to the sample tested and does not apply to the bulk.

This report is issued in confidence to the client and it will be strictly treated as such by the SHENZHEN TIMEWAY TESTING LABORATORIES. It may not be reproduced rather in its entirety or in part and it may not be used for advertising. The client to whom the report is issued may, however, show or send it, or a certified copy thereof prepared by the SHENZHEN TIMEWAY TESTING LABORATORIES, to his customer. Supplier or others persons directly concerned. SHENZHEN TIMEWAY TESTING LABORATORIES, will not, without the consent of the client enter into any discussion of correspondence with any third party concerning the contents of the report.

In the event of the improper use of the report. The SHENZHEN TIMEWAY TESTING LABORATORIES, reserves the rights to withdraw it and to adopt any other remedies which may be appropriate.



Inside view

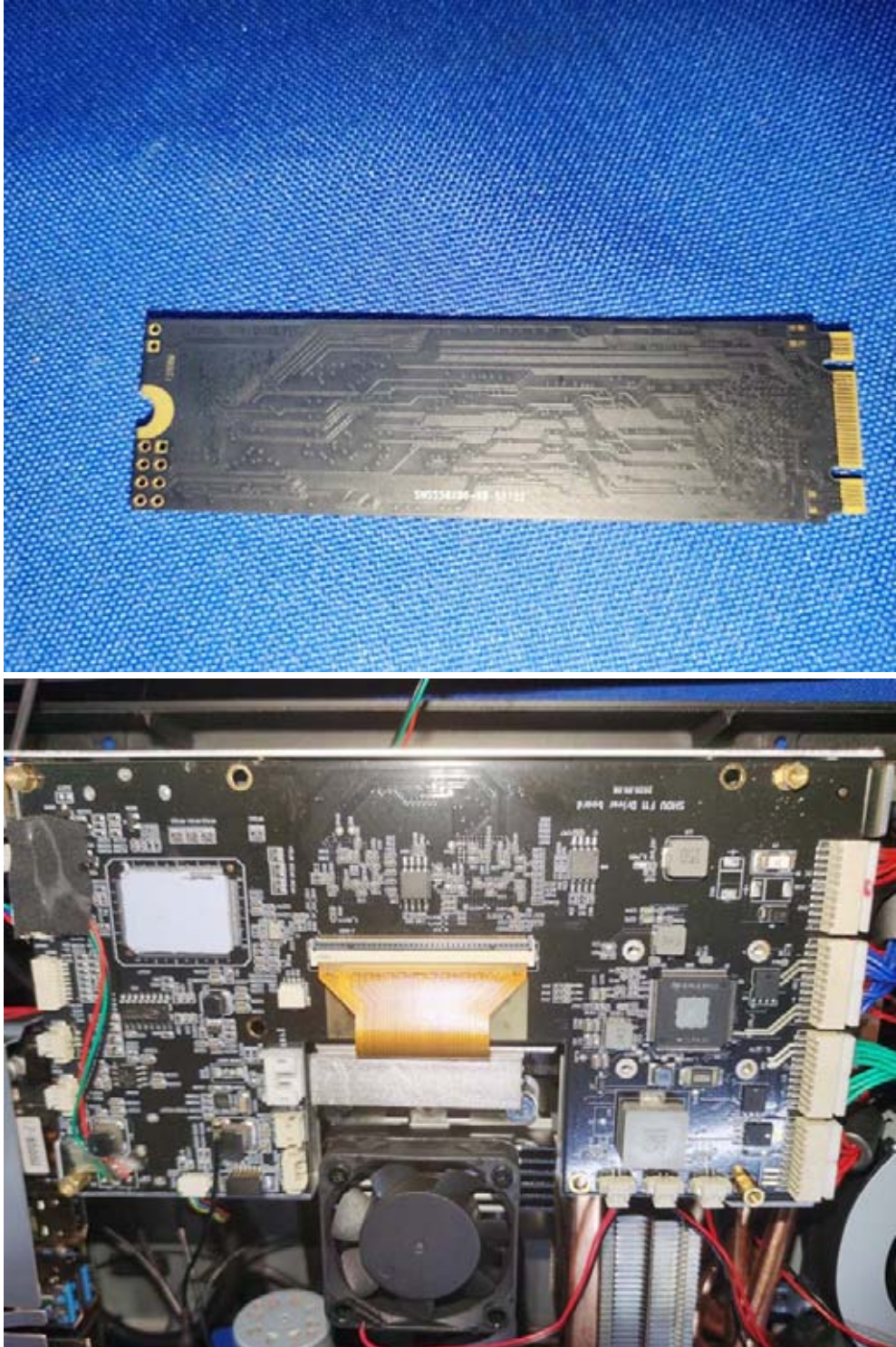

The report refers only to the sample tested and does not apply to the bulk.

This report is issued in confidence to the client and it will be strictly treated as such by the SHENZHEN TIMEWAY TESTING LABORATORIES. It may not be reproduced rather in its entirety or in part and it may not be used for advertising. The client to whom the report is issued may, however, show or send it, or a certified copy thereof prepared by the SHENZHEN TIMEWAY TESTING LABORATORIES, to his customer. Supplier or others persons directly concerned. SHENZHEN TIMEWAY TESTING LABORATORIES, will not, without the consent of the client enter into any discussion of correspondence with any third party concerning the contents of the report. In the event of the improper use of the report. The SHENZHEN TIMEWAY TESTING LABORATORIES, reserves the rights to withdraw it and to adopt any other remedies which may be appropriate.



Inside view

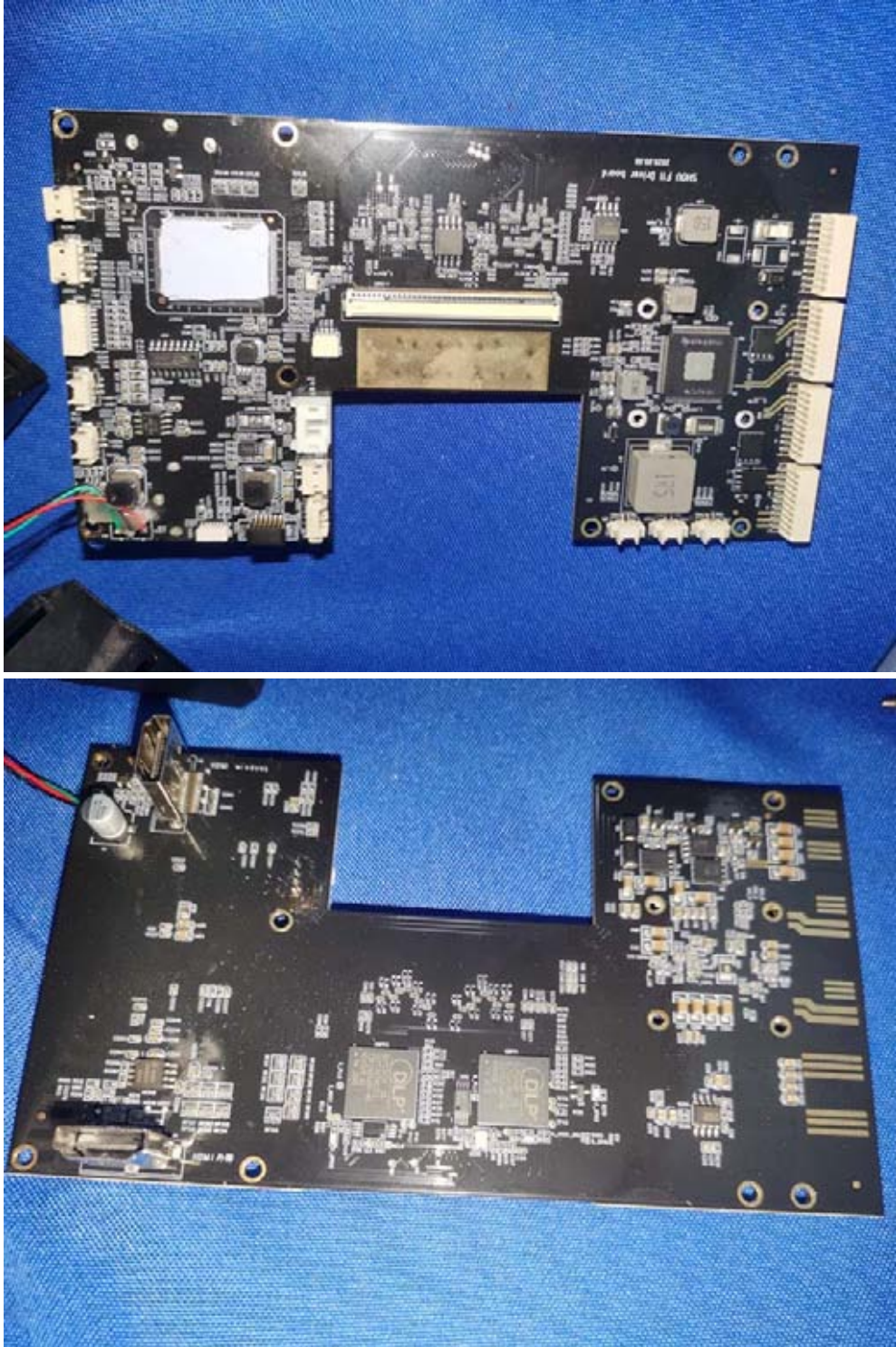

The report refers only to the sample tested and does not apply to the bulk.

This report is issued in confidence to the client and it will be strictly treated as such by the SHENZHEN TIMEWAY TESTING LABORATORIES. It may not be reproduced rather in its entirety or in part and it may not be used for advertising. The client to whom the report is issued may, however, show or send it, or a certified copy thereof prepared by the SHENZHEN TIMEWAY TESTING LABORATORIES, to his customer. Supplier or others persons directly concerned. SHENZHEN TIMEWAY TESTING LABORATORIES, will not, without the consent of the client enter into any discussion of correspondence with any third party concerning the contents of the report. In the event of the improper use of the report. The SHENZHEN TIMEWAY TESTING LABORATORIES, reserves the rights to withdraw it and to adopt any other remedies which may be appropriate.





Inside view

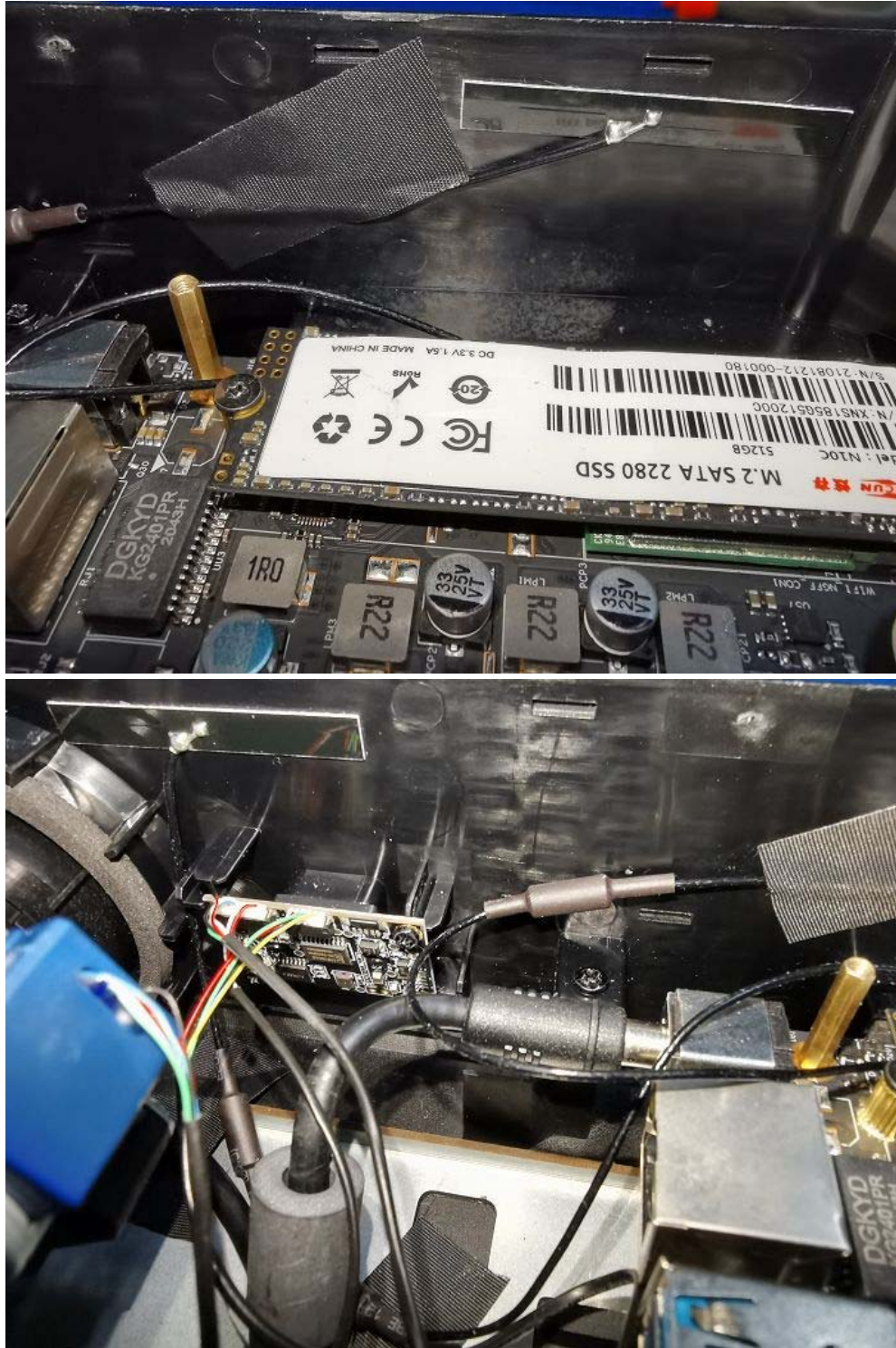

The report refers only to the sample tested and does not apply to the bulk.

This report is issued in confidence to the client and it will be strictly treated as such by the SHENZHEN TIMEWAY TESTING LABORATORIES. It may not be reproduced rather in its entirety or in part and it may not be used for advertising. The client to whom the report is issued may, however, show or send it, or a certified copy thereof prepared by the SHENZHEN TIMEWAY TESTING LABORATORIES, to his customer, Supplier or others persons directly concerned. SHENZHEN TIMEWAY TESTING LABORATORIES, will not, without the consent of the client enter into any discussion of correspondence with any third party concerning the contents of the report. In the event of the improper use of the report. The SHENZHEN TIMEWAY TESTING LABORATORIES, reserves the rights to withdraw it and to adopt any other remedies which may be appropriate.



Inside view

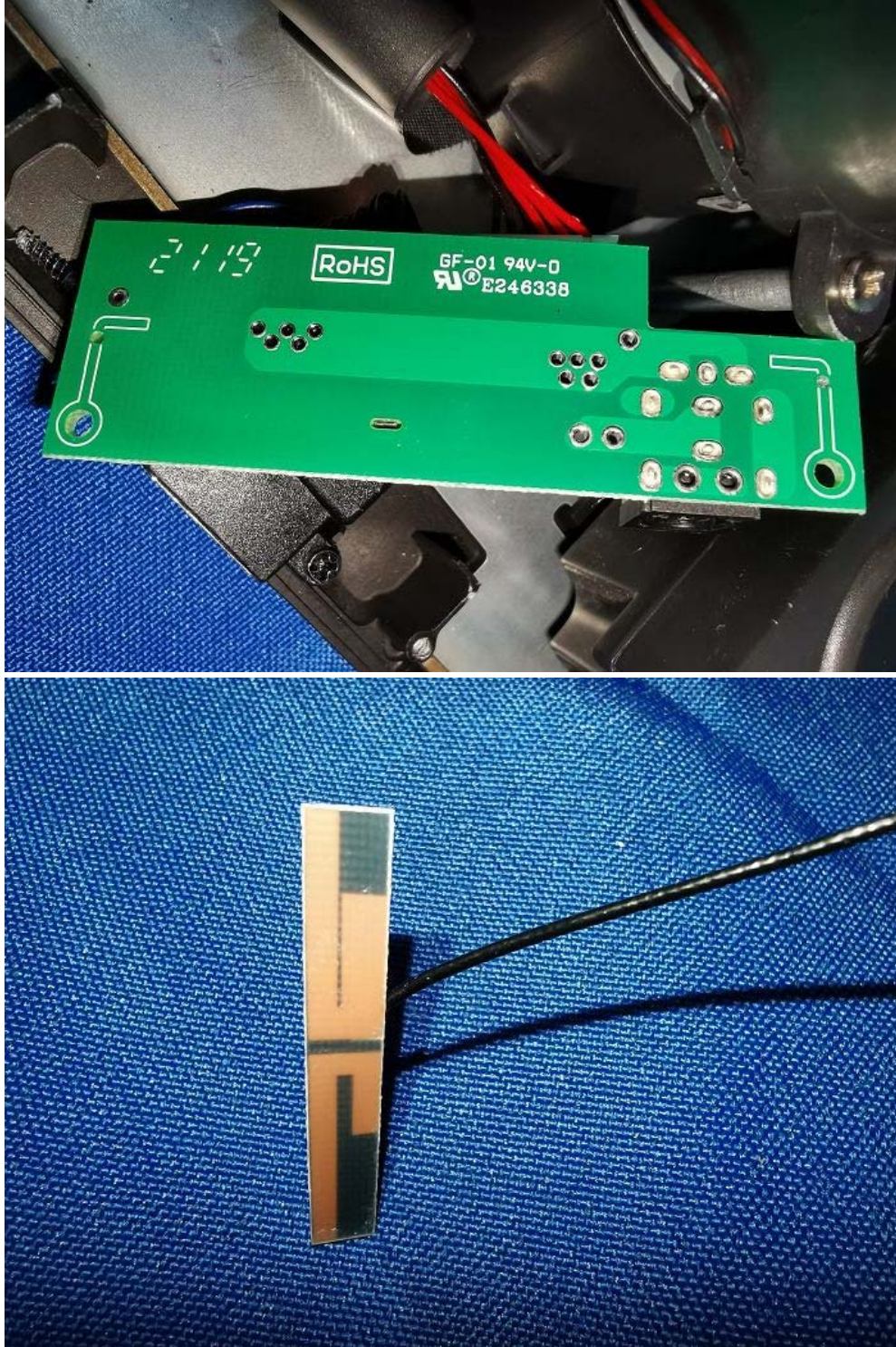

The report refers only to the sample tested and does not apply to the bulk.

This report is issued in confidence to the client and it will be strictly treated as such by the SHENZHEN TIMEWAY TESTING LABORATORIES. It may not be reproduced rather in its entirety or in part and it may not be used for advertising. The client to whom the report is issued may, however, show or send it, or a certified copy thereof prepared by the SHENZHEN TIMEWAY TESTING LABORATORIES, to his customer. Supplier or others persons directly concerned. SHENZHEN TIMEWAY TESTING LABORATORIES, will not, without the consent of the client enter into any discussion of correspondence with any third party concerning the contents of the report. In the event of the improper use of the report. The SHENZHEN TIMEWAY TESTING LABORATORIES, reserves the rights to withdraw it and to adopt any other remedies which may be appropriate.

Inside view

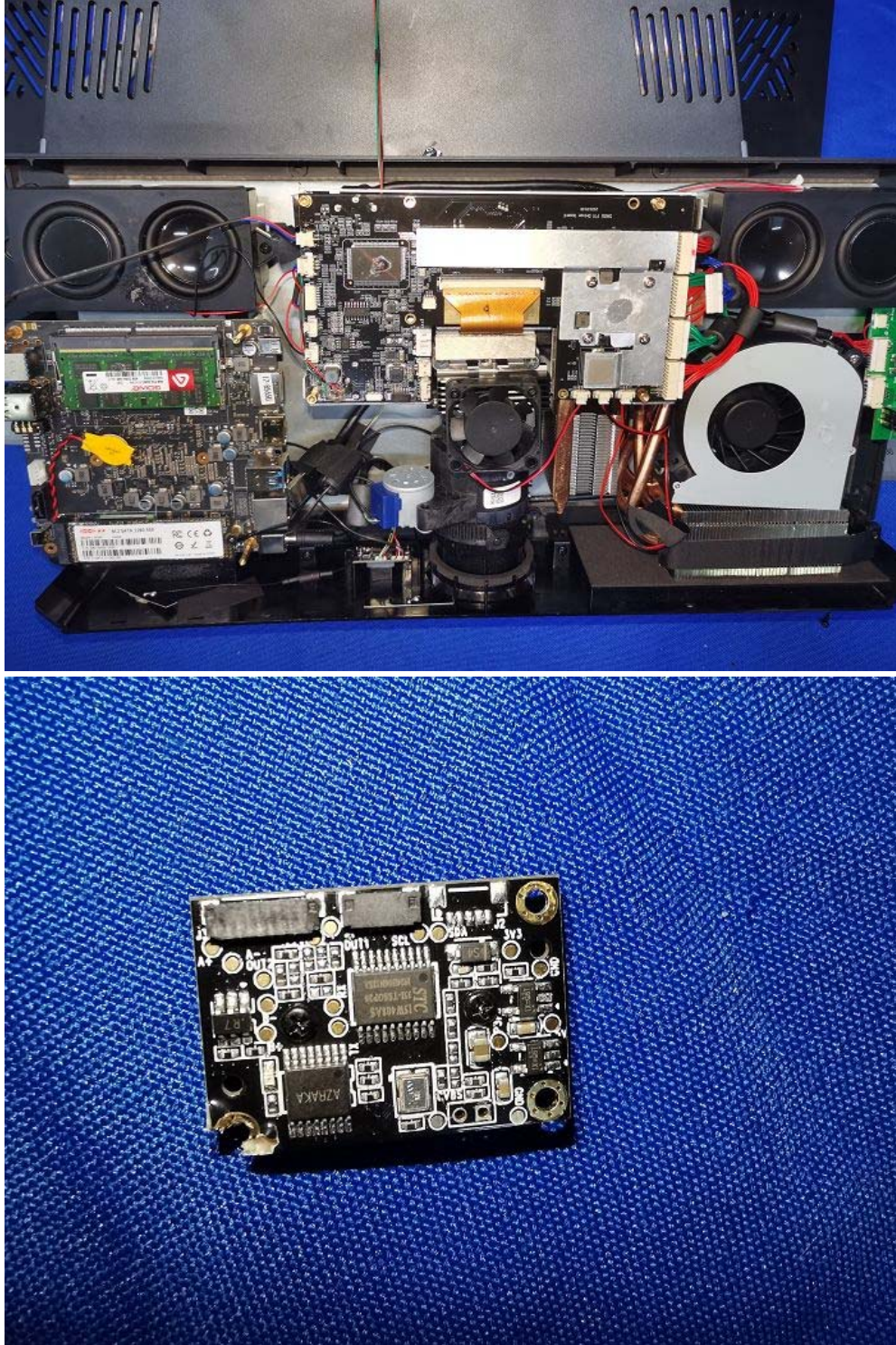

The report refers only to the sample tested and does not apply to the bulk.

This report is issued in confidence to the client and it will be strictly treated as such by the SHENZHEN TIMEWAY TESTING LABORATORIES. It may not be reproduced rather in its entirety or in part and it may not be used for advertising. The client to whom the report is issued may, however, show or send it, or a certified copy thereof prepared by the SHENZHEN TIMEWAY TESTING LABORATORIES, to his customer. Supplier or others persons directly concerned. SHENZHEN TIMEWAY TESTING LABORATORIES, will not, without the consent of the client enter into any discussion of correspondence with any third party concerning the contents of the report. In the event of the improper use of the report. The SHENZHEN TIMEWAY TESTING LABORATORIES, reserves the rights to withdraw it and to adopt any other remedies which may be appropriate.

Inside view

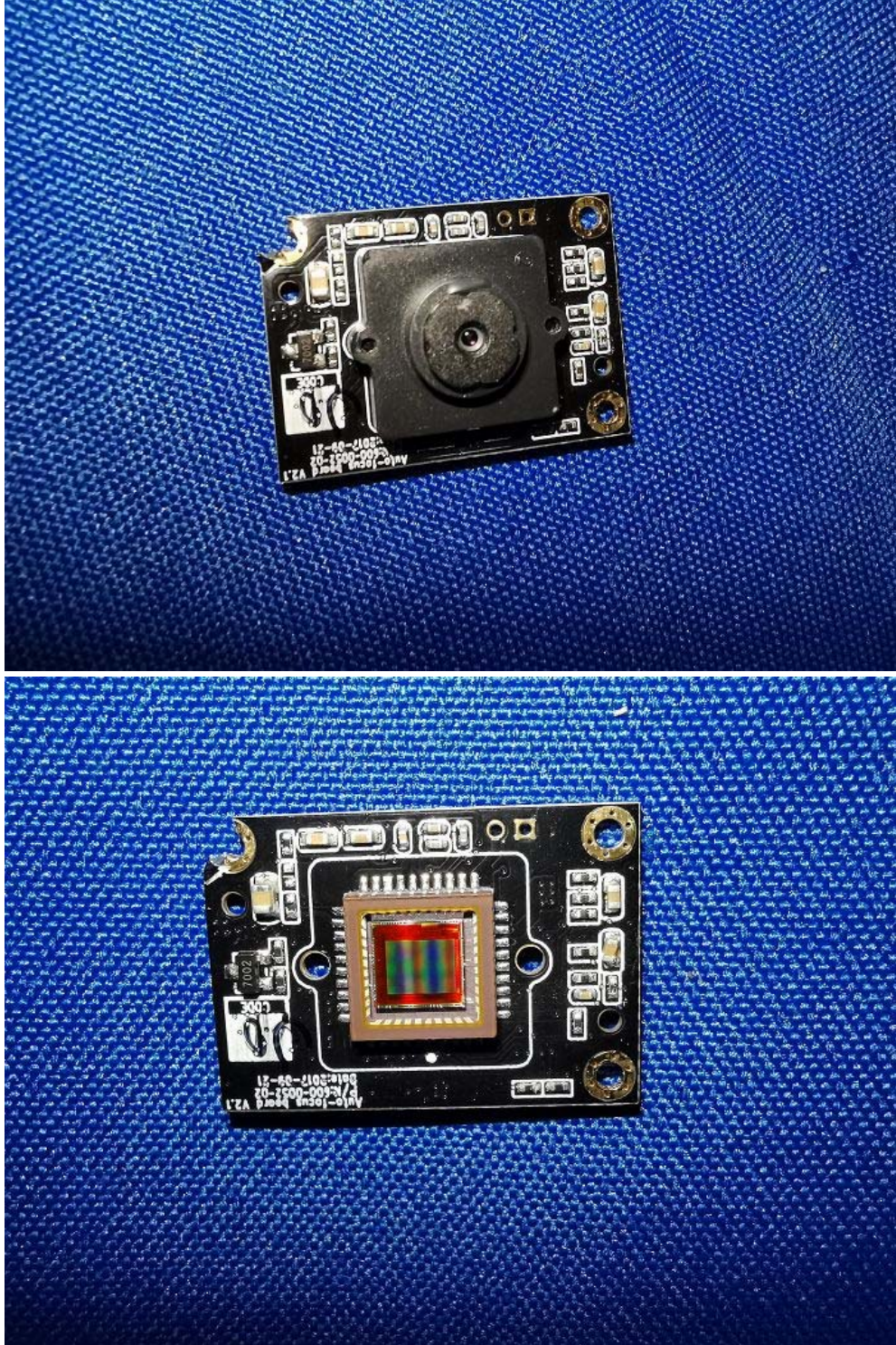

The report refers only to the sample tested and does not apply to the bulk.

This report is issued in confidence to the client and it will be strictly treated as such by the SHENZHEN TIMEWAY TESTING LABORATORIES. It may not be reproduced rather in its entirety or in part and it may not be used for advertising. The client to whom the report is issued may, however, show or send it, or a certified copy thereof prepared by the SHENZHEN TIMEWAY TESTING LABORATORIES, to his customer, Supplier or others persons directly concerned. SHENZHEN TIMEWAY TESTING LABORATORIES, will not, without the consent of the client enter into any discussion of correspondence with any third party concerning the contents of the report. In the event of the improper use of the report. The SHENZHEN TIMEWAY TESTING LABORATORIES, reserves the rights to withdraw it and to adopt any other remedies which may be appropriate.

Inside view

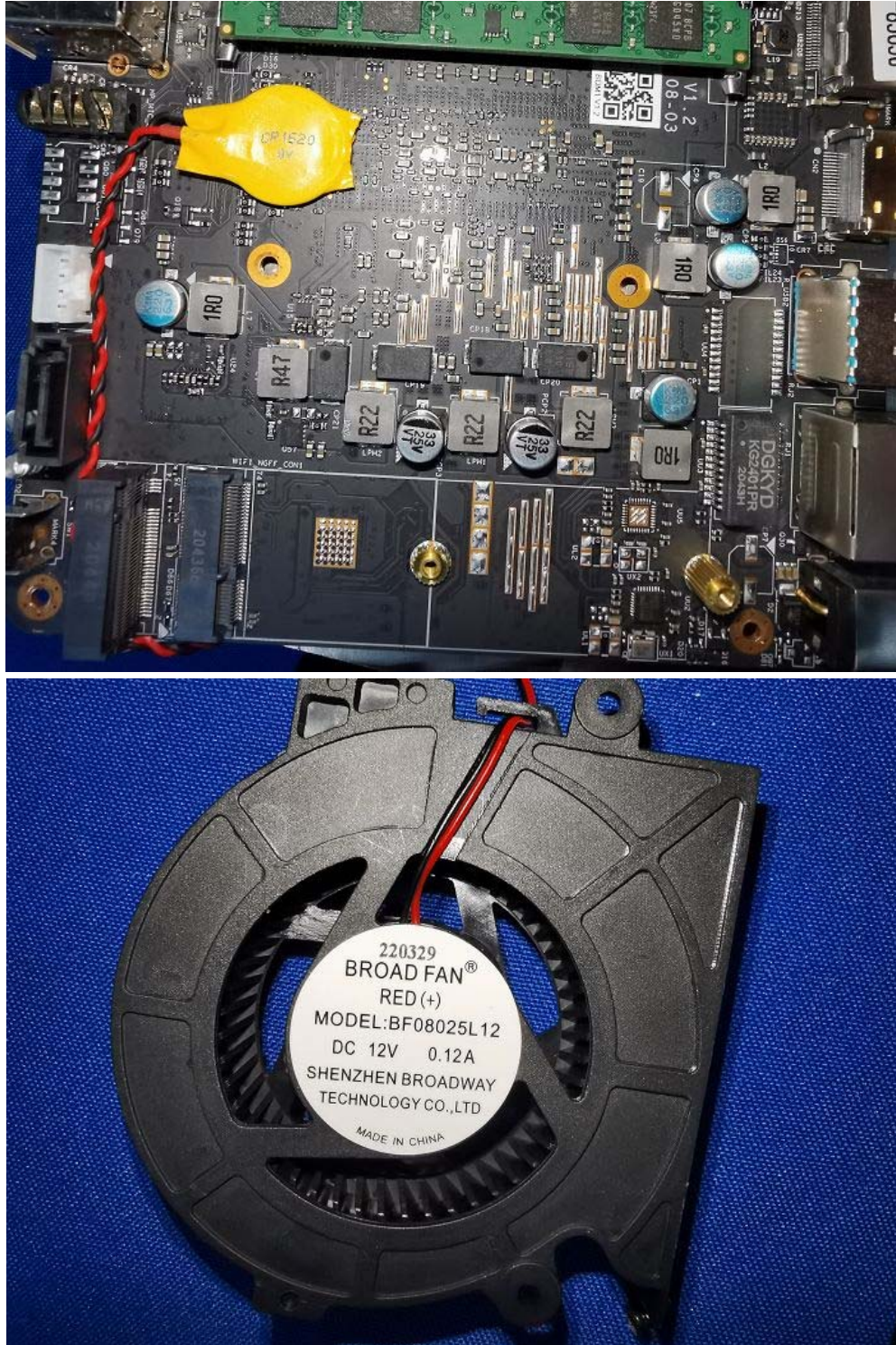

The report refers only to the sample tested and does not apply to the bulk.  
This report is issued in confidence to the client and it will be strictly treated as such by the SHENZHEN TIMEWAY TESTING LABORATORIES. It may not be reproduced rather in its entirety or in part and it may not be used for advertising. The client to whom the report is issued may, however, show or send it, or a certified copy thereof prepared by the SHENZHEN TIMEWAY TESTING LABORATORIES, to his customer. Supplier or others persons directly concerned. SHENZHEN TIMEWAY TESTING LABORATORIES, will not, without the consent of the client enter into any discussion of correspondence with any third party concerning the contents of the report.  
In the event of the improper use of the report. The SHENZHEN TIMEWAY TESTING LABORATORIES, reserves the rights to withdraw it and to adopt any other remedies which may be appropriate.

Inside view

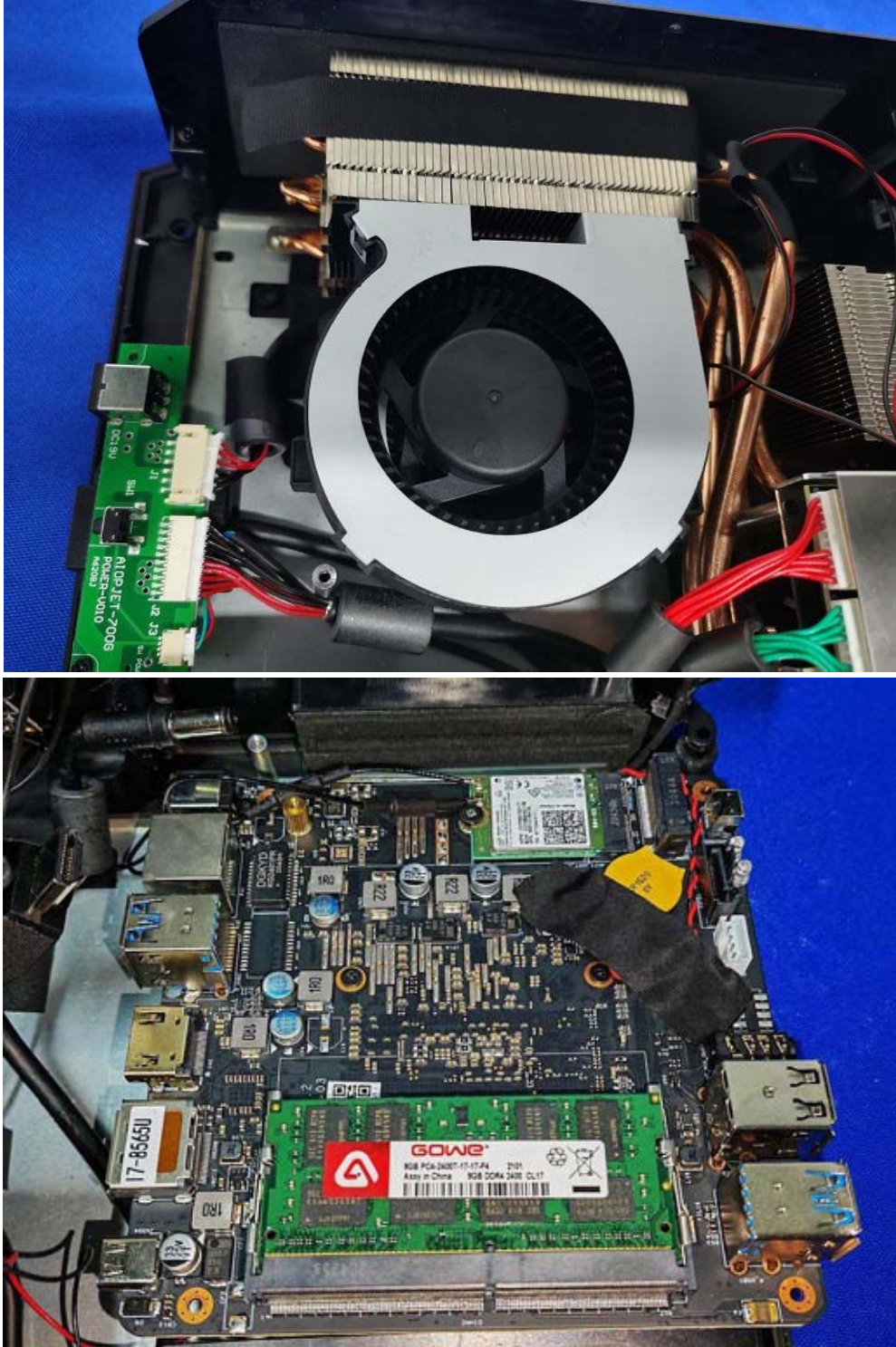

The report refers only to the sample tested and does not apply to the bulk.

This report is issued in confidence to the client and it will be strictly treated as such by the SHENZHEN TIMEWAY TESTING LABORATORIES. It may not be reproduced rather in its entirety or in part and it may not be used for advertising. The client to whom the report is issued may, however, show or send it . or a certified copy there of prepared by the SHENZHEN TIMEWAY TESTING LABORATORIES. to his customer. Supplier or others persons directly concerned. SHENZHEN TIMEWAY TESTING LABORATORIES. will not, without the consent of the client enter into any discussion of correspondence with any third party concerning the contents of the report. In the event of the improper use of the report. The SHENZHEN TIMEWAY TESTING LABORATORIES. reserves the rights to withdraw it and to adopt any other remedies which may be appropriate.



Inside view

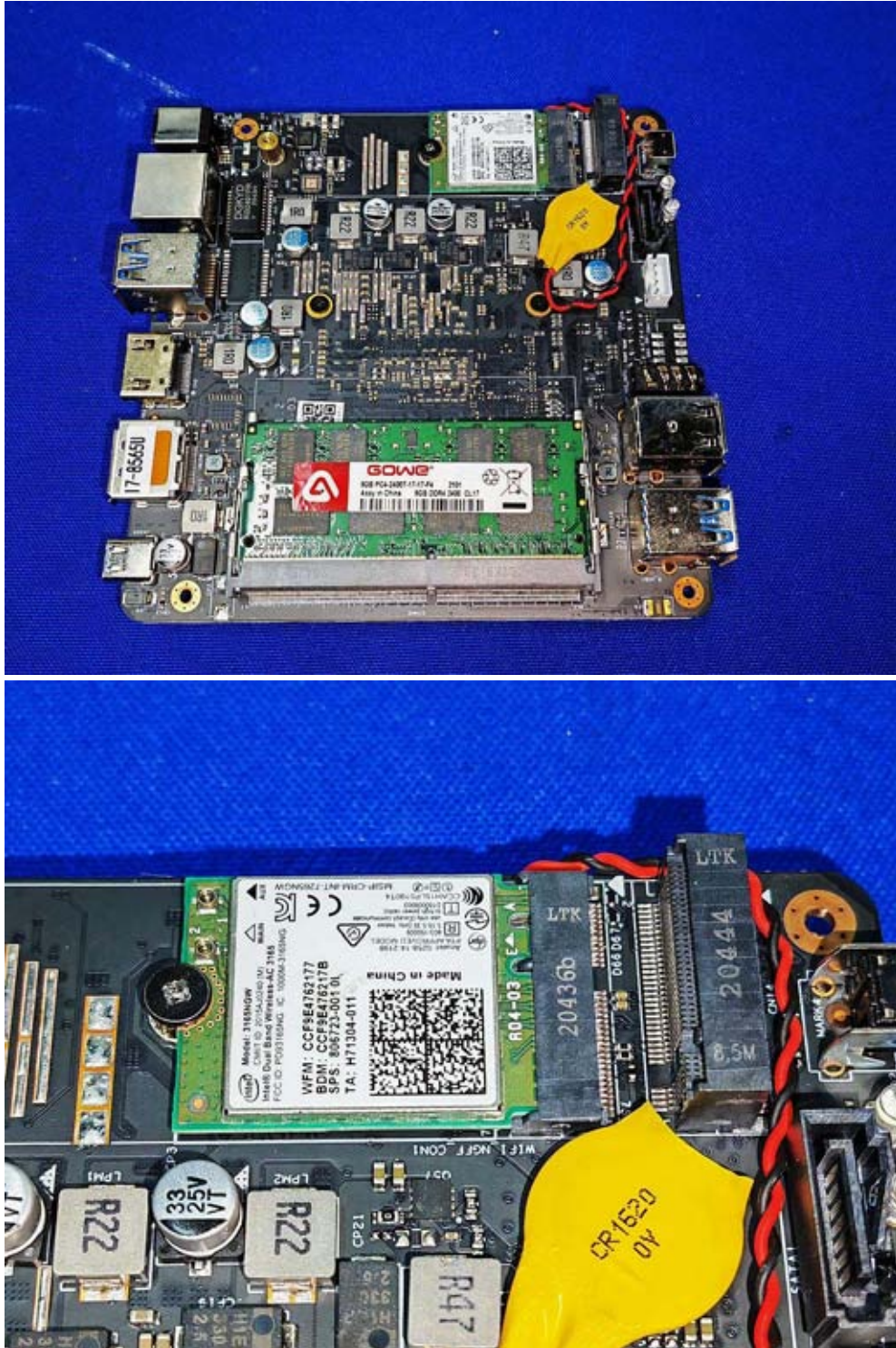

The report refers only to the sample tested and does not apply to the bulk.

This report is issued in confidence to the client and it will be strictly treated as such by the SHENZHEN TIMEWAY TESTING LABORATORIES. It may not be reproduced rather in its entirety or in part and it may not be used for advertising. The client to whom the report is issued may, however, show or send it, or a certified copy thereof prepared by the SHENZHEN TIMEWAY TESTING LABORATORIES, to his customer. Supplier or others persons directly concerned. SHENZHEN TIMEWAY TESTING LABORATORIES, will not, without the consent of the client enter into any discussion of correspondence with any third party concerning the contents of the report. In the event of the improper use of the report. The SHENZHEN TIMEWAY TESTING LABORATORIES, reserves the rights to withdraw it and to adopt any other remedies which may be appropriate.



Inside view

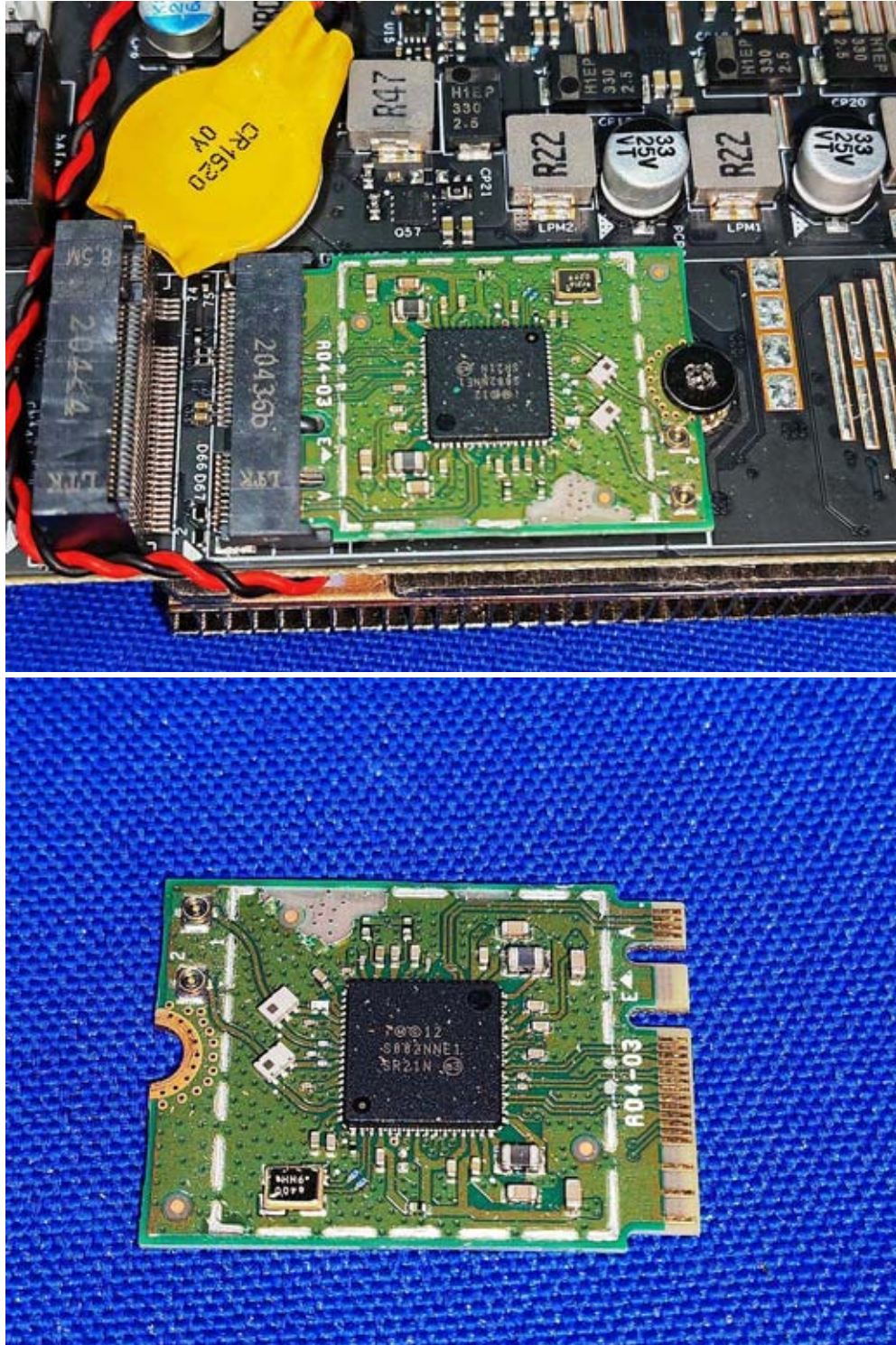

The report refers only to the sample tested and does not apply to the bulk.

This report is issued in confidence to the client and it will be strictly treated as such by the SHENZHEN TIMEWAY TESTING LABORATORIES. It may not be reproduced rather in its entirety or in part and it may not be used for advertising. The client to whom the report is issued may, however, show or send it, or a certified copy thereof prepared by the SHENZHEN TIMEWAY TESTING LABORATORIES, to his customer. Supplier or others persons directly concerned. SHENZHEN TIMEWAY TESTING LABORATORIES, will not, without the consent of the client enter into any discussion of correspondence with any third party concerning the contents of the report. In the event of the improper use of the report. The SHENZHEN TIMEWAY TESTING LABORATORIES, reserves the rights to withdraw it and to adopt any other remedies which may be appropriate.





Inside view

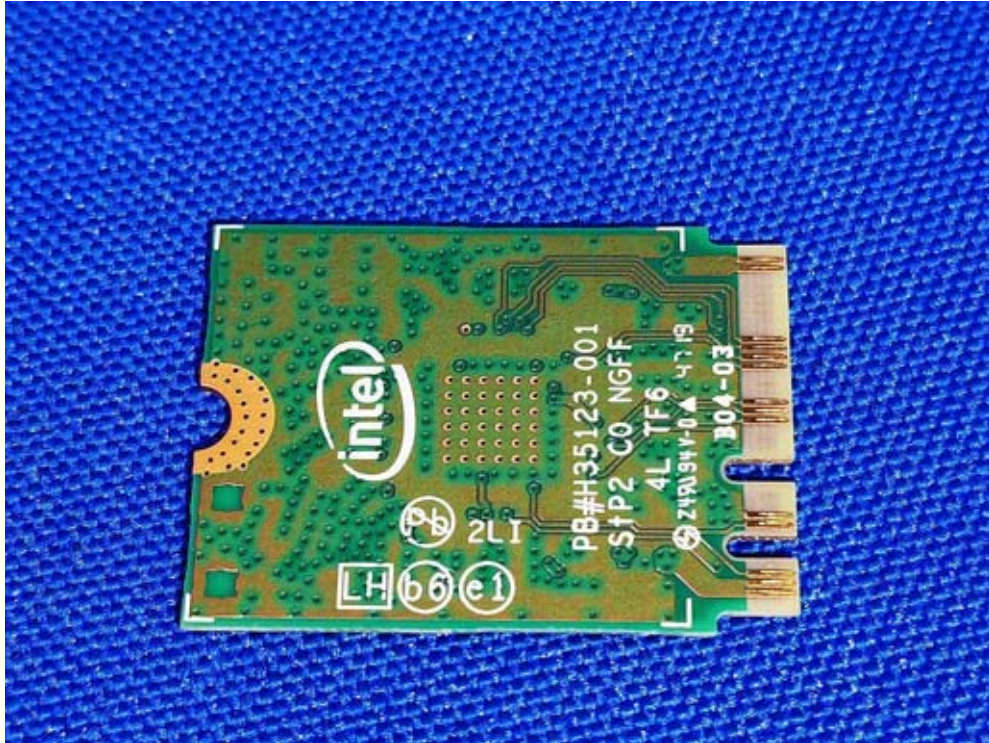

**--End of Report--**

The report refers only to the sample tested and does not apply to the bulk.

This report is issued in confidence to the client and it will be strictly treated as such by the SHENZHEN TIMEWAY TESTING LABORATORIES. It may not be reproduced rather in its entirety or in part and it may not be used for advertising. The client to whom the report is issued may, however, show or send it or a certified copy thereof prepared by the SHENZHEN TIMEWAY TESTING LABORATORIES to his customer. Supplier or others persons directly concerned. SHENZHEN TIMEWAY TESTING LABORATORIES will not, without the consent of the client enter into any discussion of correspondence with any third party concerning the contents of the report. In the event of the improper use of the report. The SHENZHEN TIMEWAY TESTING LABORATORIES reserves the rights to withdraw it and to adopt any other remedies which may be appropriate.