

# ACT FIRE

## USER MANUAL

READ ALL INSTRUCTIONS AND WARNINGS BEFORE USING

### COMPONENTS

1. Padded headband
2. Battery compartment
3. Headband wires
4. Guide arms
5. Turn on /turn off controls
6. Two microphones
7. Audio input & micro-USB charging
8. Bluetooth controls

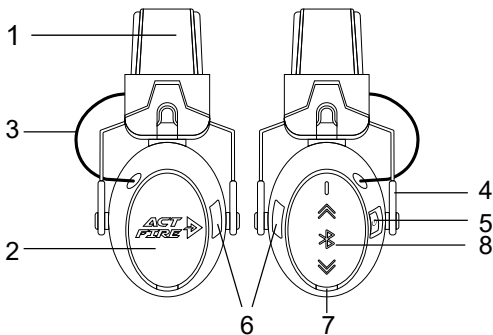

## Installing Batteries:

Install two 1.5V AA batteries or optional Alpha 1100 rechargeable battery pack as shown.

Replace battery door top-end first.

Note:

- Do not mix old and new batteries
- Do not mix alkaline, standard or rechargeable batteries

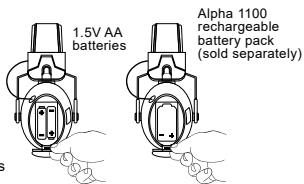

## Charging Battery Pack:

(sold separately)

(NOTE: The batteries must be Rechargeable Batteries.)

Insert the micro-USB connector cable into the micro-USB jack. Connect the other end of the cable to a USB power source to begin charging. The LED will blink when the battery pack is charging and turn solid when charging is complete.

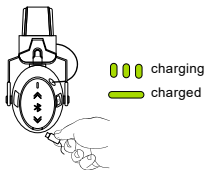

## Power and Volume:

Press and hold power button for 3 seconds to power ON/OFF headset. Voice Assist will announce "Power ON" or "Power OFF."

Adjust ambient volume using UP and DOWN arrows on right cup.

Performance is best when volume is set to lowest level needed for conversation

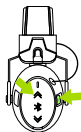

## Fitting Headset:

Fully extend sliders and place cups over ears so that microphones are facing forward.

Then, tighten headband using sliders.

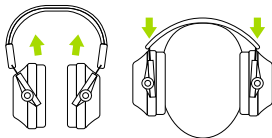

• To reduce the risks associated with harmful noise:

- Always wear hearing protectors when you are exposed to noise.
- Ensure hearing protection is properly fitted. Follow any fitting instructions included with this product.
- Do not bend or reshape the headband as this will cause a loose fit and sound leakage.
- For best protection, the ear cushions should seal firmly against your head. Anything that interferes with the seal, such as long hair (pull back to the extent possible), thick or poorly fitting eyeglass temples, pencils or caps, will lessen the protection.
- Do not immerse in water. Clean with a damp cloth and mild soap. Do not use harsh or abrasive chemicals.
- Earmuffs must be regularly inspected for cracks or worn parts and for proper fitting. Replace as needed.
- only: Do not change between "Dosimeter ON" and "Limiter ON" settings during a single workday.
- Do not store the hearing protector in direct sunlight or at temperature above 131°F (55°C)

 CAUTION

• To reduce the risks associated with chemical exposure and fire:



- Do not store with the batteries installed. A leaking battery may cause bodily injury or damage to the hearing protector. The WEEE logo (shown at the left) appears on the product to indicate that this product must not be disposed of or dumped with your other household wastes. You are liable to dispose of all your electronic or electrical waste equipment by relocating over to the specified collection point for recycling of such hazardous waste. Dispose of components in accordance with all applicable local and governmental regulations

## NOISE REDUCTION RATING (NRR)

### EXAMPLE

1. The environmental noise level as measured at the ear is 92 decibels dB(A).
2. The NRR is 24 dB(A).
3. The level of noise entering the ear is approximately 68 dB(A).

The NRR for the Wireless Electronic Hearing Protector is 24 dB(A).

Improper fit of this device will reduce its effectiveness in attenuating noise.

Consult the enclosed instructions for proper fit.

# SAFETY INFORMATION

## FCC Caution:

Any Changes or modifications not expressly approved by the party responsible for compliance could void the user's authority to operate the equipment.

This device complies with part 15 of the FCC Rules. Operation is subject to the following two conditions:

- (1) This device may not cause harmful interference.
- (2) this device must accept any interference.

received, including interference that may cause undesired operation.

Note: This equipment has been tested and found to comply with the limits for a Class B digital device, pursuant to part 15.

FCC Rules. These limits are designed to provide reasonable protection against harmful interference in a residential installation. This equipment generates uses and can radiate radio frequency energy and, if not installed and used in accordance with the instructions, may cause harmful interference to radio communications. However, there is no guarantee that interference will not occur in a particular installation. If this equipment does cause harmful interference to radio or television reception, which can be determined by turning the equipment off and on, the user is encouraged to try to correct the interference by one or more of the following measures:

- Reorient or relocate the receiving antenna.
- Increase the separation between the equipment and receiver.
- Connect the equipment into an outlet on a circuit different from that to which the receiver is connected.
- Consult the dealer or an experienced radio/TV technician for help.

This equipment complies with FCC RF radiation exposure limits set forth for an uncontrolled environment .

This transmitter must not be co-located or operating in conjunction with any other antenna or transmitter.

## ISED Warning

This device complies with Innovation, Science, and Economic Development Canada licence-exempt RSS standard(s). Operation is subject to the following two conditions:

1. This device may not cause interference, and
2. This device must accept any interference, including interference that may cause undesired operation of the device.

Le présent appareil est conforme aux CNR d Innovation, Sciences et Développement économique Canada applicables

aux appareils radio exempts de licence. L'exploitation est autorisée aux deux conditions suivantes :

1. l'appareil ne doit pas produire de brouillage, et
2. l'utilisateur de l'appareil doit accepter tout brouillage radioélectrique subi, même si le brouillage est susceptible d'en

compromettre le fonctionnement.

## Operating specifications

Item	button	The key name	effect of action	Prompt tone/voice	Indicator light	others
1	On/Off	power button	Press and hold power button for 2 seconds to power ON/ OFF	Power on Ambient listening mode/Power off		
2	Bluetooth symbol button (in the center)	Bluetooth power button	1.Press and hold power button for 3 seconds to power ON/OFF	Bluetooth mode/connected	1. Factory state: red and blue flash, 2Hz cycle	Enter pairing mode automatically
			2.Press and hold power button for 3 seconds to power OFF	Ambient listening mode	2. Connection mode: blue flashing, 1Hz cycle 3. Offline mode: red flashing, 1Hz cycle	
3		Answer/hang up	1.When a call comes, click to answer or hang up during a call.	rings		Auto-pauses music and broadcasts ringtone when playing music
4			2.When a call comes in, press for 2 seconds to reject the call	Play the reject notification tone		When playing music, it automatically pauses the music and broadcasts the ringtone, and resumes the music after being rejected successfully
5						When in the pickup mode, reduce the ambient sound volume to -20dB, and resume the original volume after hanging up or refusing the connection
6						
7		Pairing Your Headset and Phone	Press and hold power button for 5 seconds in bluetooth shutdown state to enter pairing state	Pairing On	Red and blue flash, 2Hz cycle	
8			Matching success	Connected	Blue flashing, 1Hz cycle	
9		Play/Pause	Turn on the phone player, click Play, then click Pause			
10		The next song	Click 2 to proceed to the next song			
11	In a song	Click 3, back up the last song				
12	Vol+	Vol+	Click step, level 5 with mute	Play the prompt tone when the volume is maximum		This button only controls the ambient sound volume, and the Bluetooth volume needs to be controlled through the mobile phone
13	Vol-	Vol-	Click Step Back, level 5 with mute	Play the prompt sound when the volume is minimum		

# ***ACTFIRE***

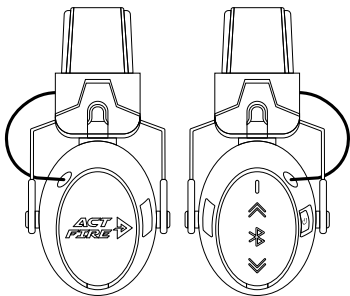

---

## How to contact us

 @Actfire

 @ACTFIRE

 [actfirestore@hotmail.com](mailto:actfirestore@hotmail.com)