

HiStone

User Manual

HK578 Series All-in-One Point-of-Sale (POS)



Qingdao Histone Intelligent Commercial System Co.,Ltd.

General User Notices

Thank you very much for choosing Histone HK578 Series POS System. Please read the user manual thoroughly and get to know deeper understandings before installing and using the machine. Keep the user manual for future reference in case of questions during the use.

In the interest of continuing product improvement, Histone reserves the right to change or update product specifications, functions, or software without notice. Features, functions, and operations described in this manual may not exactly the same since the products are sold in different regions. In some circumstances, pictures shown are illustrative prototypes only and may differ from the actual product. Contact our customer service or your dealer for the latest information before reading this user manual.

The machine installation must be carried out by a professional technician or a dealer. Histone will not accept any responsibility for damage arising out of unauthorized modification or failure to follow the instructions to replace the connected peripherals and cables.



Warning:

- Static may cause damage to the POS.
- Incorrectly replacing a battery can result in an explosion. Make sure to only replace the battery with the same or equivalent type as recommended by the manufacturer (Histone). Discard used batteries according to the manufacturer's instructions.
- Do not remove the peripheral device before you turn off the system. Turn on the system after you turn on peripheral devices and turn off the peripheral devices after you turn off the system.

The manufacturer reserves the right to change or modify any information or specifications contained in this manual without prior notice.

Product Standard Number: Q/0202 RSR527

Product Name : Histone HK578 Series All-in-One Point-of-Sale (POS)

1. System Introduction

The Histone HK578 Series All-in-One Point-of-Sale (POS) adopts an open operating system, flexible component structure, and standard peripheral interface. It can be used both networking or stand-alone and applies in commercial enterprises such as retail stores, supermarkets, convenience stores, and hotels. All major components are standard parts, so the quality is reliable, easy to maintain and upgrade, also cost-effectively making it more competitive with similar products.

Basic Product Configuration

Category	Parts	HK578
System	CPU	J6412
	Memory	4G DDR4 (Up to 32G)
	Storage	128G SSD (Up to 256G)
	LCD Size	15' LCD
	Resolution	1024*768
	Touch Screen	Capacitive touch screen
	Ethernet	1*RJ45 (1000M)
	Second Display (optional)	15' LCD 1024*768 10.4' LCD 800*600
External	Audio	1*3W
	Card Reader (optional)	Magnetic card reader /RFID reader
	Fingerprint Reader (optional)	Support

2. I/O Panel

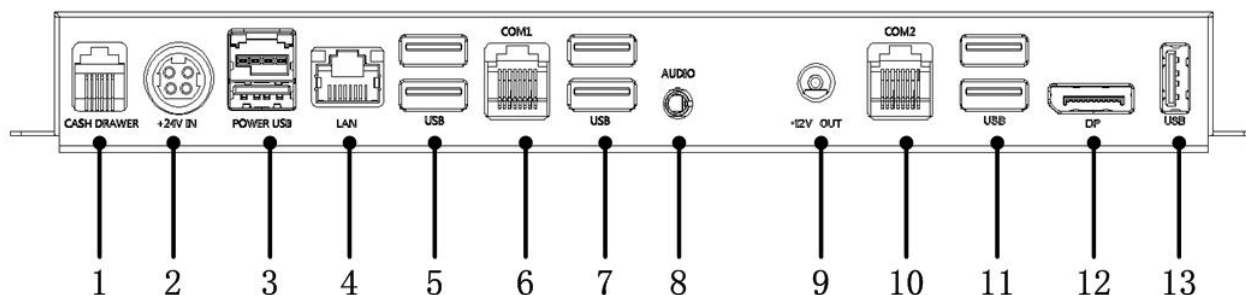

- | | |
|---------------|-------------|
| 1、Cash Drawer | 2、24V DC_IN |
| 3、PowerUSB | 4、RJ45 LAN |
| 5、USB*2 | 6、RJ50 COM |
| 7、USB*2 | 8、Audio |
| 9、12V DC_OUT | 10、RJ50 COM |
| 11、USB*2 | 12、DP |
| 13、USB*1 | |

3. Environmental Absolute Grade

Category		Description
Environment	Power Input	AC 100~240V 50-60Hz (grounding)
	Working Temperature	0°C - 40°C
	Working Humidity	35% ~ 80%
	Storage Temperature	-20°C - 55°C
	Storage Humidity	20% ~ 93%

4. System Dimensions

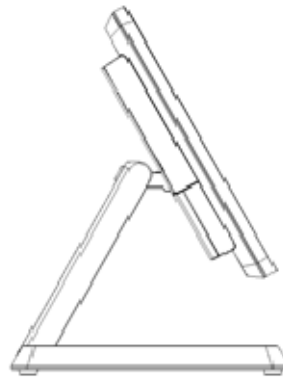
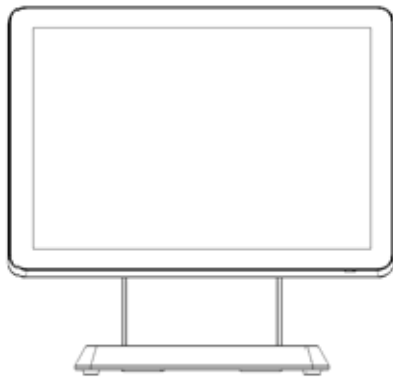

Dual-screen 15+15 Device, W x D x H: 349 x 252 x 331

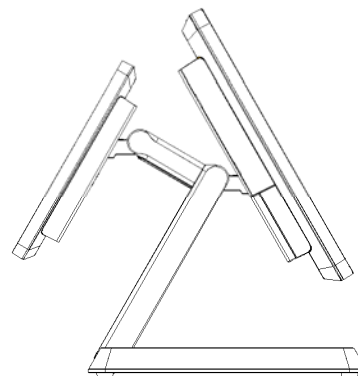
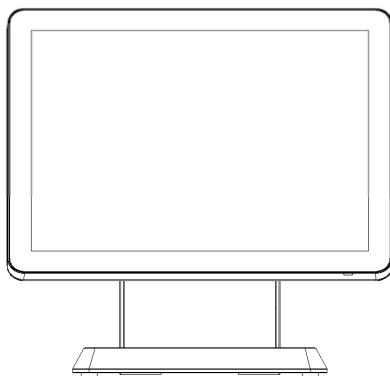

Dual-screen Device 15+10.4 W x D x H: 349 x 320 x 331

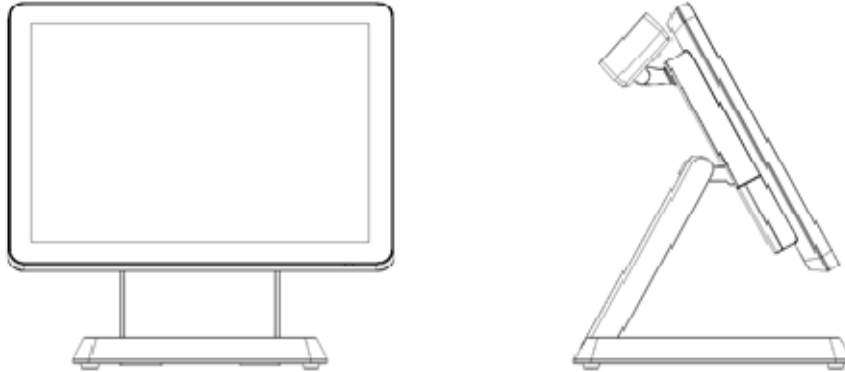

Dual-screen Device 15+10.4 W X D X H: 349 X 320 X 331

5. Unpacking and Inspection

- 1) Before unpacking, inspect the outer packing box is in good condition and check if there is any visible damage. Contact your dealer if you notice that the package is damaged as soon as possible.
- 2) The HK528 series product is carefully packed in an EPE cushion and in a carton box to protect it. Check the packaging bag for any damage before removing them.
- 3) When taking out the machine from the carton handle it carefully and avoid bumping.
- 4) Check the packing accessories and ensure the items are included: a power adapter, a power cable and connecting cables.
- 5) Check the machine and inspect it for obvious scratches or appearance damages.
- 6) The machine must be installed by a service technician or by an authorized dealer.

6. Instruction for Usage

1) Switching Instruction

- Start-up: When the adapter is connected, press the Power button on the right back side of the bottom of the machine, see the button indicator light on, then start-up can be achieved.

2) Instructions for using magnetic stripe cards

- When swiping the card, the machine should be placed on a hard horizontal plane.
- Please scratch the magnetic strip of the magnetic strip card inward from the swipe slot.
- The card swiping process should be smooth and uniform.

3) Instructions for using RFID contactless cards

- The RFID contactless card reader module is located behind the right side of the Host. (with a contactless payment sign)
- When the induction card is not received, please place the card above the induction area.

7. Safety Notes

- 1) The cash register requires that the external power supply should be grounded well. The ground resistance value should be less than 0.1Ω and the machine must connect to a grounded international three 3-pin power socket. If the power supply is ungrounded or improperly grounded may cause leakage current. It will be hazardous to the user and also affect the normal operation of the cash register.
- 2) During the operation, must use a three 3-pin power socket and a UPS that meet CCC certification national standards. It needs to be grounded well and the supply voltage shall be stable. Make sure the voltage of the outlet provides shall be in line with the voltage marked on the label of the unit.
- 3) The unit shall be used under dry, ventilated & clean environment away from sunlight. Avoid making the air vent of the host machine blocked or covered. Ensure the air vent has an exhaust outlet with a certain opening gap.
- 4) The product is a Level A one, it may cause radio interference in living environment. In such case, users may need to take practical & feasible measures against the interference.
- 5) Be sure neither to lengthen cable nor to replace parts at your will, if you have any

- demand, please contact with the reseller.
- 6) Be sure not to unplug or plug in any live part or external device when they are in energized state, and the connecting cables of the POS between parts shall be connected securely.
 - 7) When inserting USB flash or disk, you shall kill virus to prevent the host machine from virus. Android doesn't support NTFS file system. If the USB flash drive you insert is NTFS file system, it won't be supported.
 - 8) Do not switch on or off the host frequently, because it is easy to result in damage on the machine.
 - 9) Be sure not to sprinkle any liquid or fall any object into the unit.
 - 10) Be sure not to keep heavy, strenuous movement, shake & heavy strike away from the POS.
 - 11) If any liquid sprinkles or any sundry falls into the unit, please shut it down immediately & switch off power supply, take batteries down, dry the liquid or remove the sundry. If you take the batteries down, you shall reset CMOS.
 - 12) In case of safety fault, such as peculiar smell, abnormal sound, leakage, and other faults, you must switch off the power supply at once and then contact with reseller. When the POS is not in use, you shall switch off power supply. Do not directly turn off the main power supply, you should exit the application program, turn off the machine, then turn off the main power supply, and put on a dust cover.

8. Declaration of the Presence Condition of the Restricted Substances Marking

Unit 部件 名称	Condition of the Restricted Substances Marking 有毒有害物质或元素					
	铅(Pb)	汞 (Hg)	镉 (Cd)	六价铬 (Cr6+)	多溴联苯 (PBB)	多溴二苯醚 (PBDE)
Main Board 主板	○	○	○	○	○	○
Internal Storage 内存	○	○	○	○	○	○
Hard Disk 硬盘	○	○	○	○	○	○
Power 电源	○	○	○	○	○	○
Main Display 显示器	○	○	○	○	○	○
Customer Display 顾客显示器	○	○	○	○	○	○
Keyboard 键盘	○	○	○	○	○	○
Printer 打印机	○	○	○	○	○	○
CPU Fan CPU 风扇	○	○	○	○	○	○
Cables 各种线缆	○	○	○	○	○	○
Cash Drawer 钱箱	○	○	○	○	○	○
Chassis 机箱	○	○	○	○	○	○
Packaging Carton 包装箱	○	○	○	○	○	○

*本标准格式依据SJ/T11364的规定编制。

This table is prepared in accordance with the provisions of SJ/T 11364.

O: 表示该有毒有害物质在该部件所有均质材料中的含量均在GB/T26572规定的限量要求以下。 O: Indicates that this toxic or hazardous substance contained in all of the homogeneous materials for this part is below the limit requirement in GB/T 26572.

X: 表示该有毒有害物质至少在该部件的某一均质材料中的含量超出GB/T26572规定的限量要求。 X: Indicates that this toxic or hazardous substance contained in at least one of the homogeneous materials used for this part is above the limit requirement in GB/T 26572.

9. Accessories Annexes

No.	Item	Qty	Note
1	POS	1	
2	Adaptor	1	
3	Power Cable	1	

10. Others

For the drivers of other peripheral devices, refer to the USB driver from the package.
You can log in to Histone website or contact Histone via 24h customer service hotline.

Website : <http://hics.Histonetec.com>

24h customer service hotline : 4006-585-111

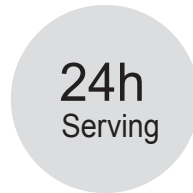

24h customer service hotline

4006-585-111

QC :

HiStone

QINGDAO HISTONE INTELLIGENT COMMERCIAL SYSTEM CO.,LTD.

HQ Office: Qingdao, China

Phone: 0086-532-55751230

Fax: 0086-532-55751234

Website: <http://hics.Histonetec.com/>

FCC Statement:

This device complies with part 15 of the FCC Rules. Operation is subject to the following two conditions: (1) This device may not cause harmful interference, and (2) this device must accept any interference received, including interference that may cause undesired operation.

This equipment has been tested and found to comply with the limits for a Class B digital device, pursuant to part 15 of the FCC Rules. These limits are designed to provide reasonable protection against harmful interference in a residential installation. This equipment generates, uses and can radiate radio frequency energy and, if not installed and used in accordance with the instructions, may cause harmful interference to radio communications. However, there is no guarantee that interference will not occur in a particular installation. If this equipment does cause harmful interference to radio or television reception, which can be determined by turning the equipment off and on, the user is encouraged to try to correct the interference by one or more of the following measures:

- Reorient or relocate the receiving antenna.
- Increase the separation between the equipment and receiver.
- Connect the equipment into an outlet on a circuit different from that to which the receiver is connected.
- Consult the dealer or an experienced radio/TV technician for help. Caution: Any changes or modifications not expressly approved by the party responsible for compliance could void the user's authority to operate the equipment.

This equipment complies with FCC radiation exposure limits set forth for an uncontrolled environment. This transmitter must not be co-located or operating in conjunction with any other antenna or transmitter.

This equipment should be installed and operated with minimum distance 20cm between the radiator&your body.