

Wifi

Intelligent Solar Energy Alert PTZ Camera User Manual



V2. 2

1:PRODUCTS & PACKING LIST

1.1 Product picture:



1.2 Packing list:

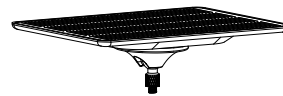

1* Solar panel

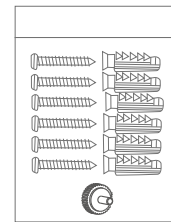

1*Screw kit

- 1*Hexagon spanner
- 1*Screw driver
- 6*Screws
- 6*Tapping screw
- 1* USB charging cable

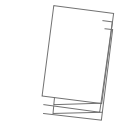

1*User manual



1*Extra power
cable 3M

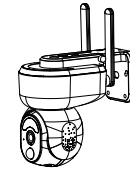

1* PTZ Camera

- 1 -

Product Diagram

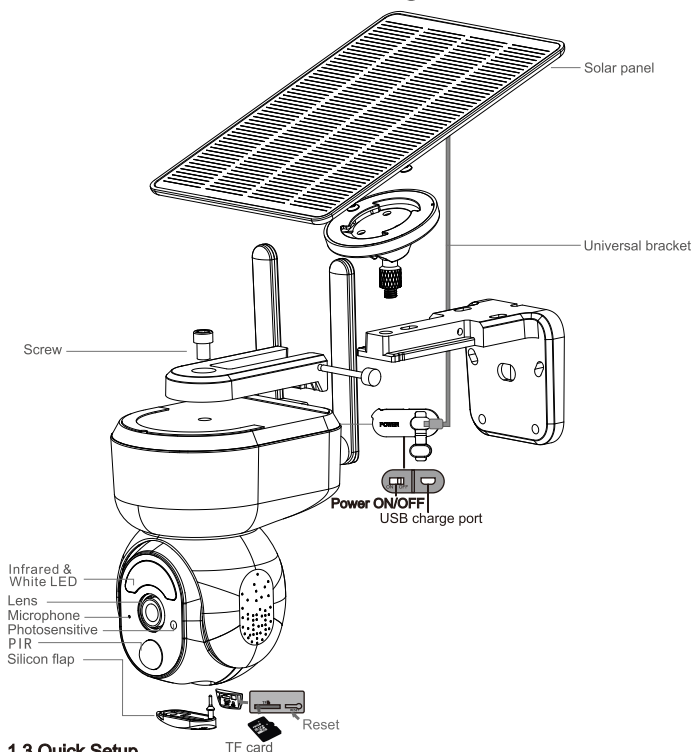

1.3 Quick Setup

- 1.3.1 Insert the USB cable of solar panel to the "USB" Silicon Flap on the bracket base for battery charging.
- 1.3.2 Press the Power switch to turn **ON/OFF** the camera,
- 1.3.3 Wait the voice prompt step by step for pairing the camera with the APP.

1.4 Note:

- 1.4.1 Before you turn on the camera, please close the silicon flap to avoid rain leakage.
- 1.4.2. Make sure your phone is connecting to the 2.4Ghz wifi firstly before you pairing the camera.

- 2 -

2 .INSTALLATION

2.1 Intergrated installation

2.2 Separated installation

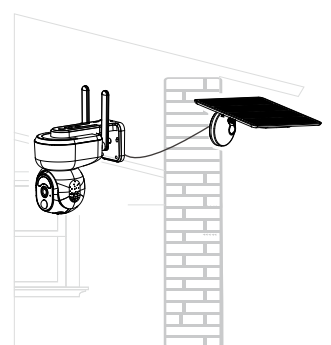
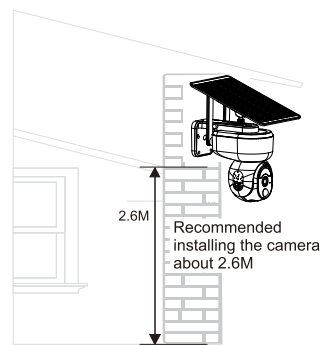

3. APP INSTALLATION

- 3.1. Scan the following QR codes or search for "UBox" from the App Store (for iOS devices) or Google Play Store (for Android smartphones) to download and install the app.



3.2. APP REGISTRATION

- 3.2. 1. Open the app then input your E-mail address then press 'Register'. Check and select to agree the agreement then your E-mail box will get a verification code. (For better user's experience, please allow to open all permissions to avoid missing any notifications from the app.)

- 3.2. 2. Input the "Verification code" and press 'Next'. (if you not found the mail you might find the code in your email spam box.)

- 3 -

3.2.3. Set the login password and confirm the login password. Then press 'Register' to next step. (For your password safety, the password requires more than 8 characters plus a combination of letters)

3.2.4. Enter your E-mail address, and input your login password. Then press 'Login'.

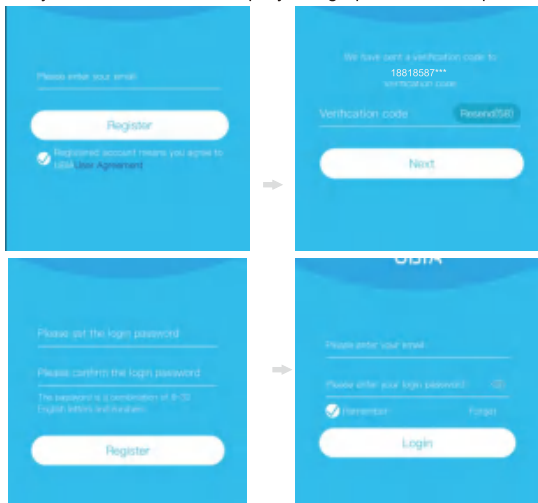

4. WI-FI CONNECTION

- 4.1. Press 'Add Family' then set the room or position as per reminders.
- 4.2. Enter your family name and then press 'Next'.
- 4.3. Input the necessary information just like Country, Province, then press 'Done'.
- 4.4. Press 'Add a device' to add a smart device

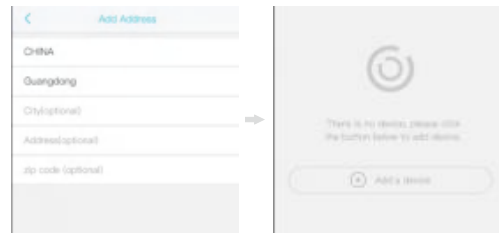
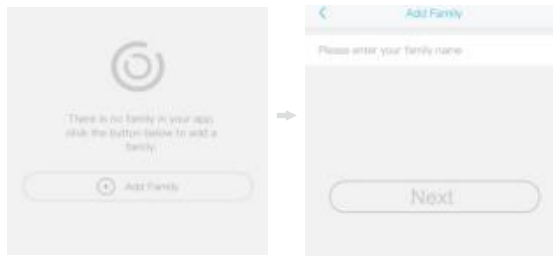

- 4.5. Connect the device with power supply, and make sure your mobile phone is disconnected to an available Wi-Fi. Then press 'Setup device'
- 4.6. After the power on the device, wait for the blue LED and voice prompt. The device is waiting for pairing, which means your device is in pairing mode.
- 4.7. If you did not hear the voice prompt, please press the RESET button until the blue indicator to light up and then release. The device will reboot and enter the pairing state.
- 4.8. The app will input the Wi-Fi name automatically, please input the correct Wi-Fi Password. Then you can choose the 'QR code configuration' or 'Sound wave configuration'.
- 4.9. Sound wave configuration: Make sure camera and mobile phone within 1M distance, you will hear the wave sound DI DI, follow the tips showed in the mobile to finish configuration.

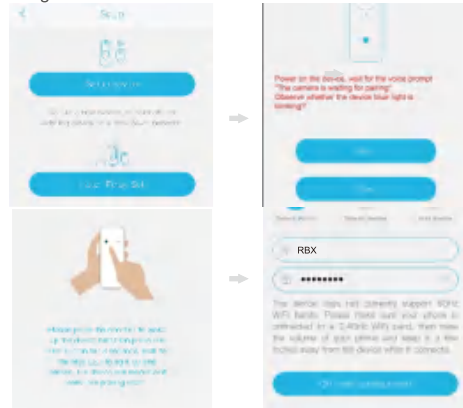

- 4.10. QR code configuration: Select the QR code configuration then the mobile phone display a QR code. Use the device to scan to the QR code 10cm away from the mobile phone.
- 4.11. Select the family name or device location then press 'Done.'
- 4.11. The device will enter to the device list automatically. Setup success! The device is ready to use.



5. DEVICE SETTING

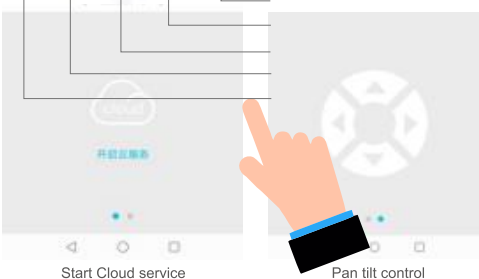
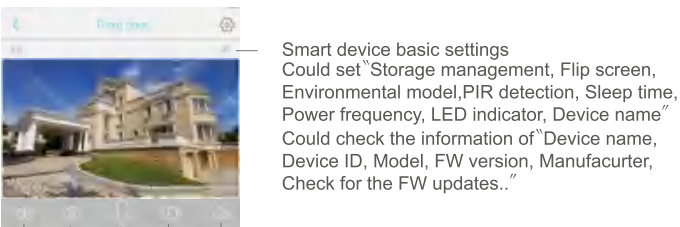
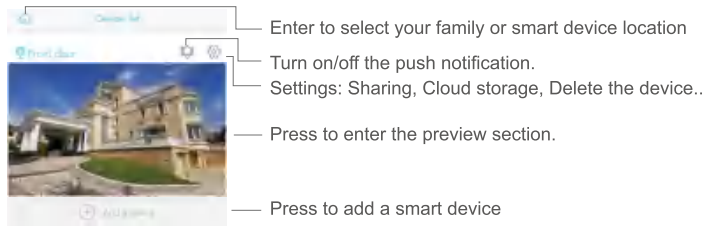

Start Cloud service

Pan tilt control

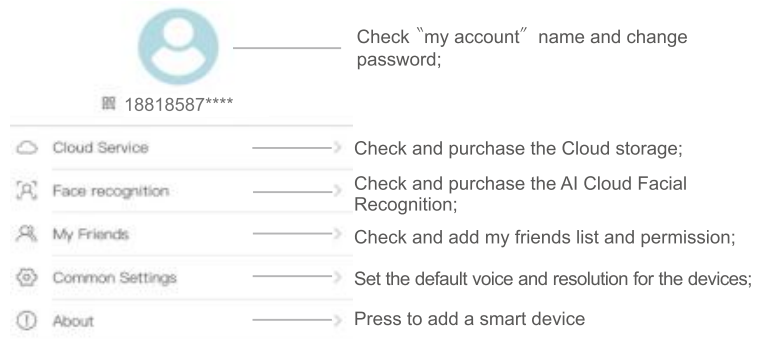

Click the "Calendar" icon on the right top corner, then choose the date to playback the videos from cloud storage.

Choose the desired date to check all videos from the cloud.

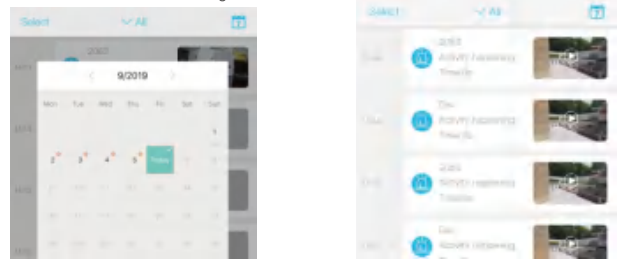

6. SPECIAL NOTES!

- 6.1. The device is equipped with a rechargeable lithium battery. The battery life will be affected by the device wake-up time and the number of wake-ups. Therefore, the PIR sensor alarm detection function is used in an environment with a lot of people. It is recommended to turn off or set the device to low sensitivity to reduce device wake-up and call times extend battery life. When the battery is low, please charge the battery immediately.
- 6.2. Keep the device in range of your router. Make sure the device is placed close to the Wi-Fi router. If there has to be thick or insulated objects between the device and the Wi-Fi router, which may lead to weak Wi-Fi signal, please make sure the Wi-Fi signal is in good level before you start using the device.
- 6.3. It is a delicate device with low power consumption design. Everytime the device is awakened and will work for few seconds. After that, the device will enter standby mode to save power. You can set the work time in the app settings.
- 6.4. Because the mainland China does not receive Google's system push messages, you need to open the app's self-starting function in your phone to receive push messages.
- 6.5. This device provides one month of free cloud storage services. If you need to continue using value-added services after the trial period expires, you need to purchase them in the app.

FCC Statement

This equipment has been tested and found to comply with the limits for a Class B digital device, pursuant to part 15 of the FCC rules. These limits are designed to provide reasonable protection against harmful interference in a residential installation. This equipment generates, uses and can radiate radio frequency energy and, if not installed and used in accordance with the instructions, may cause harmful interference to radio communications. However, there is no guarantee that interference will not occur in a particular installation. If this equipment does cause harmful interference to radio or television reception, which can be determined by turning the equipment off and on, the user is encouraged to try to correct the interference by one or more of the following measures:

- Reorient or relocate the receiving antenna.
- Increase the separation between the equipment and receiver.
- Connect the equipment into an outlet on a circuit different from that to which the receiver is connected.
- Consult the dealer or an experienced radio/TV technician for help.

To assure continued compliance, any changes or modifications not expressly approved by the party.

Responsible for compliance could void the user's authority to operate this equipment. (Example- use only shielded interface cables when connecting to computer or peripheral devices).

This equipment complies with Part 15 of the FCC Rules. Operation is subject to the following two conditions:

- (1) This device may not cause harmful interference, and
- (2) This device must accept any interference received, including interference that may cause undesired operation.

FCC Radiation Exposure Statement:

The equipment complies with FCC Radiation exposure limits set forth for uncontrolled environment. This equipment should be installed and operated with minimum distance 20cm between the radiator and your body.

Any Changes or modifications not expressly approved by the party responsible for compliance could void the user's authority to operate the equipment.