



TEST REPORT

Applicant: Dongguan Rui Xin Electronic Technology Co., Ltd.
Address of Applicant: Room 602, Building 2 No. 198 DaTang Road, Dalingshan Town, Dongguan City, Guangdong Province, China
Manufacturer/Factory: Dongguan Rui Xin Electronic Technology Co., Ltd.
Address of Manufacturer/Factory: Room 602, Building 2 No. 198 DaTang Road, Dalingshan Town, Dongguan City, Guangdong Province, China
Product Name: WIRELESS SPORT EARBUDS
Model No.: SEB6M03-083,TEB6S01-066,TEB6S00-067,SEB6M01-080, SEB6M00-081,SEB6M48-082,SEB6S01-084,SEB6S00-085, SEB6S48-086,SEB6S03-087
Trade Mark: N/A
FCC ID: 2A36W-SEB6M03-083
Applicable standards: FCC CFR Title 47 Part 15 Subpart C Section 15.247
Date of Test: Jan.04, 2023- Jan.12, 2023
Date of report issued: Jan.30, 2023
Test Result : PASS *

* In the configuration tested, the EUT complied with the standards specified above.

Remark:

The results shown in this test report refer only to the sample(s) tested , this test report cannot be reproduced, except in full without prior written permission of the company.

The report would be invalid without specific stamp of test institute and the signatures of compiler and approver

Prepared By

Shenzhen ETR Standard Technology Co., Ltd.

Address: No.103, No.10, Phase I, Zone 3, Xinxing Industrial Park, Xinhe, Fuhai Street, Bao'an District, Shenzhen, Guangdong, China

Compiled by:

Project Engineer

Reviewed by:

Project Manager

Approved by:

Authorized Signature



Report Revision History

Report No.	Description	Issue Date
ET-23010008E	Original	Jan.30, 2023

Contents

Page

1	TEST SUMMARY	4
2	GENERAL INFORMATION	5
2.1	GENERAL DESCRIPTION OF EUT	5
2.2	TEST MODE	7
2.3	DESCRIPTION OF SUPPORT UNITS	7
2.4	DEVIATION FROM STANDARDS	7
2.5	ABNORMALITIES FROM STANDARD CONDITIONS	7
2.6	TEST FACILITY	7
2.7	TEST LOCATION	7
2.8	ADDITIONAL INSTRUCTIONS	7
3	TEST INSTRUMENTS LIST	8
4	TEST RESULTS AND MEASUREMENT DATA	9
4.1	ANTENNA REQUIREMENT	9
4.2	CONDUCTED EMISSIONS	10
4.3	CONDUCTED PEAK OUTPUT POWER	13
4.4	20DB EMISSION BANDWIDTH	14
4.5	CARRIER FREQUENCIES SEPARATION	18
4.6	HOPPING CHANNEL NUMBER	25
4.7	DWELL TIME	27
4.8	BAND EDGE	32
4.8.1	<i>Conducted Emission Method</i>	32
4.8.2	<i>Radiated Emission Method</i>	36
4.9	SPURIOUS EMISSION	38
4.9.1	<i>Conducted Emission Method</i>	38
4.9.2	<i>Radiated Emission Method</i>	42
5	TEST SETUP PHOTO	50
6	EUT CONSTRUCTIONAL DETAILS	50

1 Test Summary

Test Item	Section in CFR 47	Result	Test by
Antenna Requirement	15.203/15.247 (c)	Pass	/
AC Power Line Conducted Emission	15.207	Pass	Qiao Li
Conducted Peak Output Power	15.247 (b)(1)	Pass	Yvan Fan
20dB Occupied Bandwidth	15.247 (a)(1)	Pass	Yvan Fan
Carrier Frequencies Separation	15.247 (a)(1)	Pass	Yvan Fan
Hopping Channel Number	15.247 (a)(1)(iii)	Pass	Yvan Fan
Dwell Time	15.247 (a)(1)(iii)	Pass	Yvan Fan
Radiated Emission	15.205/15.209	Pass	Qiao Li
Band Edge	15.247(d)	Pass	Yvan Fan

Remarks:

1. Pass: The EUT complies with the essential requirements in the standard.
2. Test according to ANSI C63.10:2013

Measurement Uncertainty

Test Item	Uncertainty Criterion	Measurement Uncertainty	Notes
Occupied Channel Bandwidth	±5%	±0.55%	(1)
RF output power, conducted	±1.5dB	±0.99dB	(1)
Power Spectral Density, conducted	±3dB	±0.61dB	(1)
Unwanted Emissions, conducted	±3dB	±0.64dB	(1)
AC Power Line Conducted Emission	±6dB	± 3.02 dB	(1)
Radiated emissions Below 1GHz	±6dB	±4.30 dB	(1)
Radiated emissions Above 1GHz	±6dB	±4.35 dB	(1)

Note (1): The measurement uncertainty is for coverage factor of k=2 and a level of confidence of 95%.

2 General Information

2.1 General Description of EUT

Product Name:	WIRELESS SPORT EARBUDS
Model No.:	SEB6M03-083,TEB6S01-066,TEB6S00-067, SEB6M01-080,SEB6M00-081,SEB6M48-082, SEB6S01-084,SEB6S00-085,SEB6S48-086,SEB6S03-087
Test Model:	SEB6M03-083
Difference of model(s)	All the model are the same circuit and RF module, except the model names and colors
Hardware Version:	V1.0
Software Version:	V1.0
Operation Frequency:	2402MHz~2480MHz
Channel numbers:	79
Channel separation:	1MHz
Battery	DC 3.7V 300mAh
Modulation type:	GFSK, $\pi/4$ -DQPSK,8DPSK
Antenna Type:	PCB Antenna
Antenna gain:	-0.58 dBi(Declare by applicant)
Power supply:	DC 3.7V from battery

Operation Frequency each of channel							
Channel	Frequency	Channel	Frequency	Channel	Frequency	Channel	Frequency
1	2402MHz	21	2422MHz	41	2442MHz	61	2462MHz
2	2403MHz	22	2423MHz	42	2443MHz	62	2463MHz
3	2404MHz	23	2424MHz	43	2444MHz	63	2464MHz
4	2405MHz	24	2425MHz	44	2445MHz	64	2465MHz
5	2406MHz	25	2426MHz	45	2446MHz	65	2466MHz
6	2407MHz	26	2427MHz	46	2447MHz	66	2467MHz
7	2408MHz	27	2428MHz	47	2448MHz	67	2468MHz
8	2409MHz	28	2429MHz	48	2449MHz	68	2469MHz
9	2410MHz	29	2430MHz	49	2450MHz	69	2470MHz
10	2411MHz	30	2431MHz	50	2451MHz	70	2471MHz
11	2412MHz	31	2432MHz	51	2452MHz	71	2472MHz
12	2413MHz	32	2433MHz	52	2453MHz	72	2473MHz
13	2414MHz	33	2434MHz	53	2454MHz	73	2474MHz
14	2415MHz	34	2435MHz	54	2455MHz	74	2475MHz
15	2416MHz	35	2436MHz	55	2456MHz	75	2476MHz
16	2417MHz	36	2437MHz	56	2457MHz	76	2477MHz
17	2418MHz	37	2438MHz	57	2458MHz	77	2478MHz
18	2419MHz	38	2439MHz	58	2459MHz	78	2479MHz
19	2420MHz	39	2440MHz	59	2460MHz	79	2480MHz
20	2421MHz	40	2441MHz	60	2461MHz		

Note:

In section 15.31(m), regards to the operating frequency range over 10 MHz, the Lowest frequency, the middle frequency, and the highest frequency of channel were selected to perform the test, and the selected channel see below:

Channel	Frequency
The lowest channel	2402MHz
The middle channel	2441MHz
The Highest channel	2480MHz

2.2 Test mode

Transmitting mode	Keep the EUT in continuously transmitting mode.
<i>Remark: For battery operated equipment, the EUT was performed using a new DC 3.7V battery.</i>	

2.3 Description of Support Units

Equipment	Model	S/N	Manufacturer
Adapter	HW-050200CH0	/	HUAWEI
USB Cable	1m	/	/

2.4 Deviation from Standards

None.

2.5 Abnormalities from Standard Conditions

None.

2.6 Test Facility

Test laboratory:	Shenzhen ETR Standard Technology Co., Ltd.
CNAS Registration Number:	L11864
A2LA Certificate Number:	6640.01
FCC Designation Number:	CN1326
FCC Test Firm Registration:	183064

2.7 Test Location

All tests were performed at:	
Laboratory location:	No.103, No.10, Phase I, Zone 3, Xinxing Industrial Park, Xinhe, Fuhai Street, Bao'an District, Shenzhen, Guangdong, China
Telephone:	+86 755 85259392
Fax:	+86 755 27219460

2.8 Additional Instructions

Test Software	BT_Tool.exe
Power level setup	Default

3 Test Instruments list

Item	Equipment name	Manufacturer	Model	Serial No.	Calibration date	Due date
1	EMI Test Receiver	Rohde&schwarz	ESPI7	100605	2022.3.09	2023.3.08
2	EMI Test Receiver	Rohde&schwarz	ESCI3	102696	2022.3.09	2023.3.08
3	Broadband antenna	schwarabeck	VULB9168	1064	2022.3.11	2024.3.10
4	Horn antenna	schwarabeck	BBHA9120D	9120D-1145	2022.3.09	2023.3.08
5	amplifier	EMtrace	RP01A	50117	2022.3.09	2023.3.08
6	Artificial power network	schwarabeck	NSLK8127	8127483	2022.3.09	2023.3.08
	Artificial power network	ETS	3186/2NM	1132	2022.3.09	2023.3.08
7	10dB attenuator	HUBER+SUHNER	10dB	/	2022.3.09	2023.3.08
8	amplifier	Space-Dtronics	EWLAN0118 G-P40	19113001	2022.3.09	2023.3.08
9	Spectrum analyzer	KEYSIGHT	N9020A	MY55370280	2022.3.09	2023.3.08
10	Power detector box	MWRFtest	MW100-PSB	MW201020JYT	2022.11.19	2023.11.18

Note: the calibration interval of the above test instruments is 12 or 24 months and the calibrations are traceable to international system unit (SI).

Software Name	Manufacturer	Model	Version
RF test software	MWRFtest	MTS 8310	V2.0.0.0
Conducted test software	EZ-EMC	Farad	Ver.EMC-CON 3A1.1
Radiated test software	EZ-EMC	Farad	Ver.FA-03A2 RE

4 Test results and Measurement Data

4.1 Antenna requirement

Standard requirement:	FCC Part15 C Section 15.203 /247(c)
15.203 requirement: An intentional radiator shall be designed to ensure that no antenna other than that furnished by the responsible party shall be used with the device. The use of a permanently attached antenna or of an antenna that uses a unique coupling to the intentional radiator, the manufacturer may design the unit so that a broken antenna can be replaced by the user, but the use of a standard antenna jack or electrical connector is prohibited.	
15.247(c) (1)(i) requirement: (i) Systems operating in the 2400-2483.5 MHz band that is used exclusively for fixed. Point-to-point operations may employ transmitting antennas with directional gain greater than 6dBi provided the maximum conducted output power of the intentional radiator is reduced by 1 dB for every 3 dB that the directional gain of the antenna exceeds 6dBi.	
E.U.T Antenna: <i>The antenna is PCB antenna, the best case gain of the is -0.58dBi, reference to the appendix II for details</i>	

4.2 Conducted Emissions

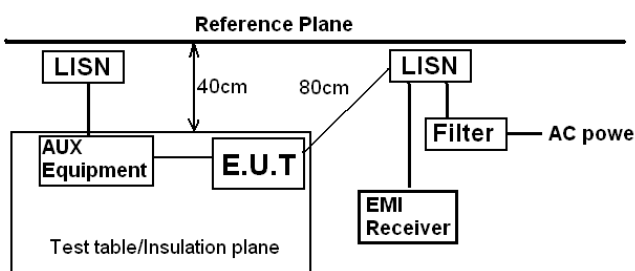
Test Requirement:	FCC Part15 C Section 15.207					
Test Method:	ANSI C63.10:2013					
Test Frequency Range:	150KHz to 30MHz					
Class / Severity:	Class B					
Receiver setup:	RBW=9KHz, VBW=30KHz, Sweep time=auto					
Limit:	Frequency range (MHz)		Limit (dBuV)			
			Quasi-peak		Average	
	0.15-0.5		66 to 56*		56 to 46*	
	0.5-5		56		46	
	5-30		60		50	
* Decreases with the logarithm of the frequency.						
Test setup:	 <p>Remark: E.U.T: Equipment Under Test LISN: Line Impedance Stabilization Network Test table height=0.8m</p>					
Test procedure:	<ol style="list-style-type: none"> 1. The E.U.T and simulators are connected to the main power through a line impedance stabilization network (L.I.S.N.). This provides a 50ohm/50uH coupling impedance for the measuring equipment. 2. The peripheral devices are also connected to the main power through a LISN that provides a 50ohm/50uH coupling impedance with 50ohm termination. (Please refer to the block diagram of the test setup and photographs). 3. Both sides of A.C. line are checked for maximum conducted interference. In order to find the maximum emission, the relative positions of equipment and all of the interface cables must be changed according to ANSI C63.10:2013 on conducted measurement. 					
Test Instruments:	Refer to section 3.0 for details					
Test mode:	Refer to section 2.2 for details					
Test environment:	Temp.:	22.6°C	Humid.:	41%	Press.:	1012mbar
Test voltage:	AC 120V, 60Hz					
Test results:	Pass					

Remark: Both high and low voltages have been tested to show only the worst low Voltage test data.

Measurement data:

Pre-scan all test modes, found worst case at 8-DPSK 2402MHz, and so only show the test result of 8-DPSK 2402MHz

Line:

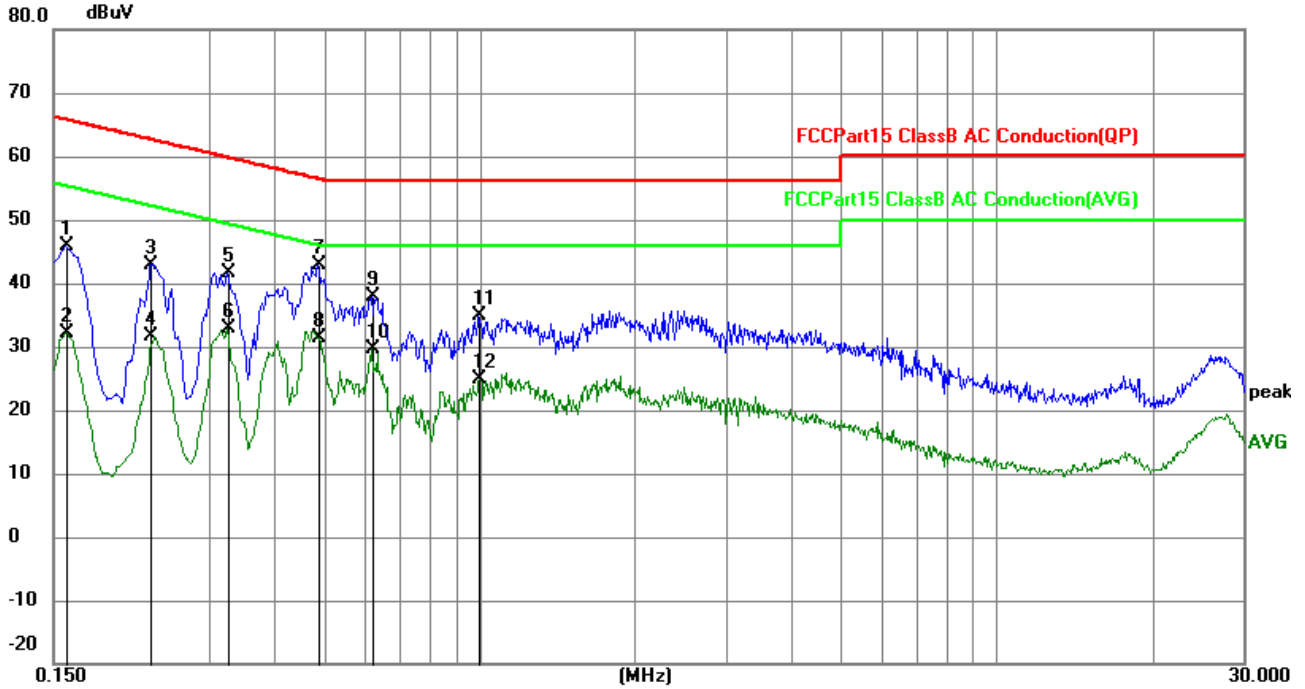

No.	Frequency (MHz)	Reading (dBuV)	Factor (dB)	Level (dBuV)	Limit (dBuV)	Margin (dB)	Detector
1	0.1590	35.44	10.48	45.92	65.52	-19.60	QP
2	0.1590	21.73	10.48	32.21	55.52	-23.31	AVG
3	0.2310	32.53	10.44	42.97	62.41	-19.44	QP
4	0.2310	21.22	10.44	31.66	52.41	-20.75	AVG
5	0.3255	31.20	10.39	41.59	59.57	-17.98	QP
6	0.3255	22.44	10.39	32.83	49.57	-16.74	AVG
7	0.4875	32.42	10.36	42.78	56.21	-13.43	QP
8	0.4875	21.13	10.36	31.49	46.21	-14.72	AVG
9	0.6179	27.51	10.34	37.85	56.00	-18.15	QP
10	0.6179	19.18	10.34	29.52	46.00	-16.48	AVG
11	0.9959	24.49	10.29	34.78	56.00	-21.22	QP
12	0.9959	14.53	10.29	24.82	46.00	-21.18	AVG

Neutral:

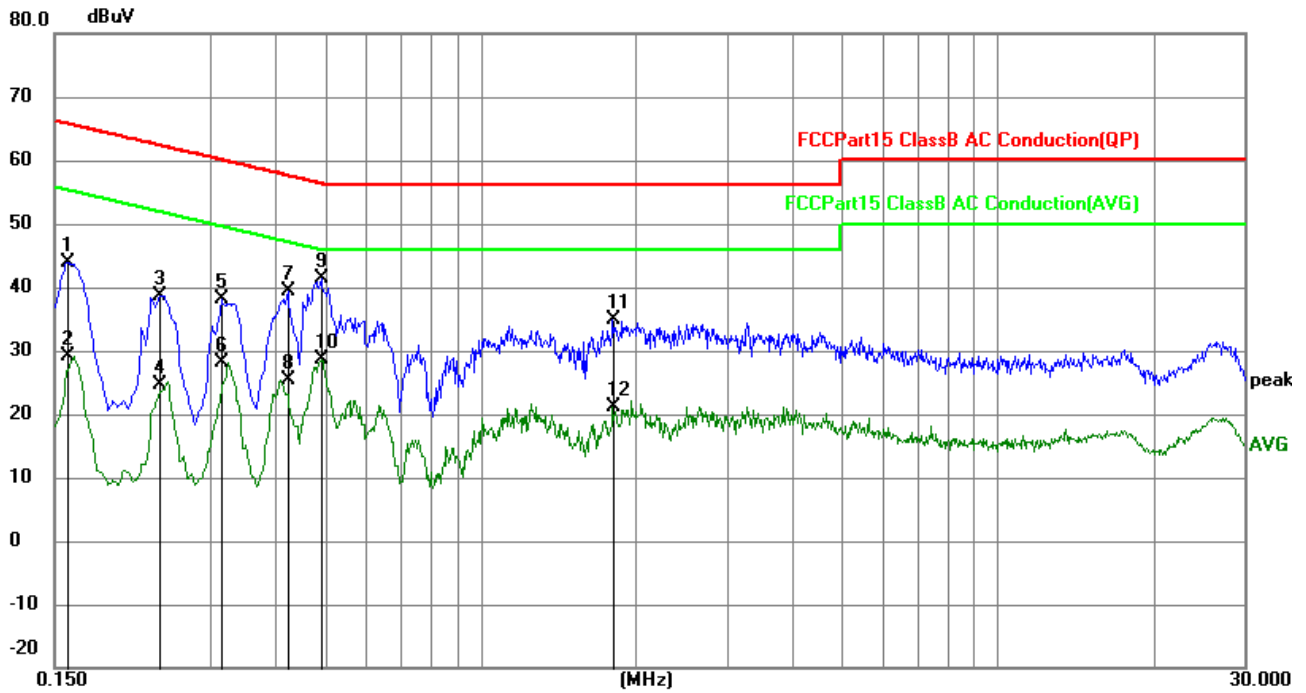

No.	Frequency (MHz)	Reading (dBuV)	Factor (dB)	Level (dBuV)	Limit (dBuV)	Margin (dB)	Detector
1	0.1590	33.42	10.48	43.90	65.52	-21.62	QP
2	0.1590	18.76	10.48	29.24	55.52	-26.28	AVG
3	0.2400	28.25	10.43	38.68	62.10	-23.42	QP
4	0.2400	14.10	10.43	24.53	52.10	-27.57	AVG
5	0.3165	27.71	10.39	38.10	59.80	-21.70	QP
6	0.3165	17.76	10.39	28.15	49.80	-21.65	AVG
7	0.4245	28.89	10.37	39.26	57.36	-18.10	QP
8	0.4245	14.98	10.37	25.35	47.36	-22.01	AVG
9	0.4920	31.14	10.36	41.50	56.13	-14.63	QP
10	0.4920	18.35	10.36	28.71	46.13	-17.42	AVG
11	1.8060	24.53	10.30	34.83	56.00	-21.17	QP
12	1.8060	10.88	10.30	21.18	46.00	-24.82	AVG

Notes:

1. An initial pre-scan was performed on the line and neutral lines with peak detector.
2. Quasi-Peak and Average measurement were performed at the frequencies with maximized peak emission.
3. Final Level = Receiver Read level + LISN Factor + Cable Loss

4.3 Conducted Peak Output Power

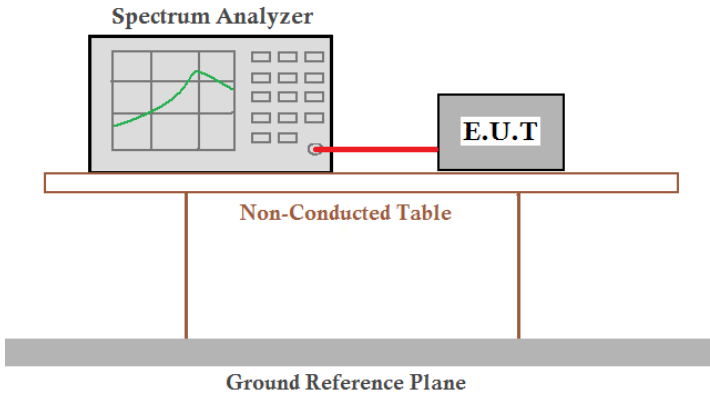
Test Requirement:	FCC Part15 C Section 15.247 (b)(1)
Test Method:	ANSI C63.10:2013 and KDB558074 D01 15.247 Meas Guidance v05r02
Limit:	30dBm(for GFSK),20.97dBm(for EDR)
Test setup:	 <p>The diagram illustrates the test setup. A Spectrum Analyzer is connected via a red cable to an E.U.T. (Equipment Under Test). Both are placed on a Non-Conducted Table. Below the table is a Ground Reference Plane.</p>
Test Instruments:	Refer to section 3.0 for details
Test mode:	Refer to section 2.2 for details
Test results:	Pass

Measurement Data

Mode	Test channel	Peak Output Power (dBm)	Limit (dBm)	Result
GFSK	Lowest	-1.68	20.97	Pass
	Middle	-2.09		
	Highest	-2.70		
$\pi/4$ -DQPSK	Lowest	-0.88	20.97	Pass
	Middle	-1.27		
	Highest	-1.85		
8-DPSK	Lowest	-0.46	20.97	Pass
	Middle	-0.86		
	Highest	-1.46		

4.4 20dB Emission Bandwidth

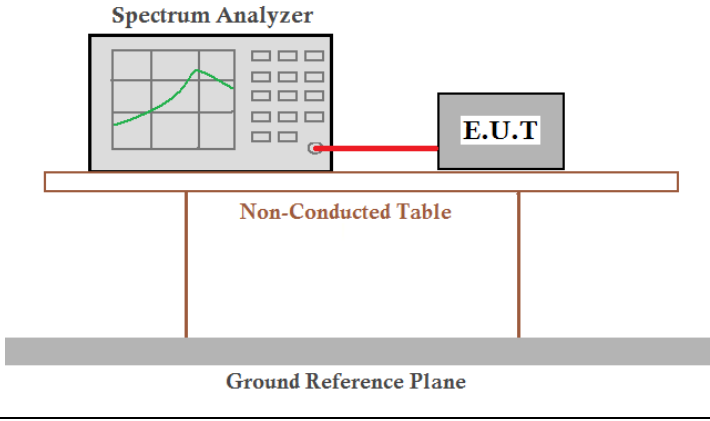
Test Requirement:	FCC Part15 C Section 15.247 (a)(1)
Test Method:	ANSI C63.10:2013 and KDB558074 D01 15.247 Meas Guidance v05r02
Limit:	N/A
Test setup:	 <p>The diagram illustrates the test setup. A Spectrum Analyzer is connected via a red cable to an E.U.T. (Equipment Under Test). Both are placed on a Non-Conducted Table. Below the table is a Ground Reference Plane.</p>
Test Instruments:	Refer to section 3.0 for details
Test mode:	Refer to section 2.2 for details
Test results:	Pass

Measurement Data

Mode	Test channel	20dB Emission Bandwidth (MHz)	Result
GFSK	Lowest	1.016	Pass
	Middle	1.018	
	Highest	1.039	
$\pi/4$ -DQPSK	Lowest	1.304	Pass
	Middle	1.320	
	Highest	1.315	
8-DPSK	Lowest	1.285	Pass
	Middle	1.301	
	Highest	1.337	

Test plot as follows:

Test mode:	GFSK mode
------------	-----------

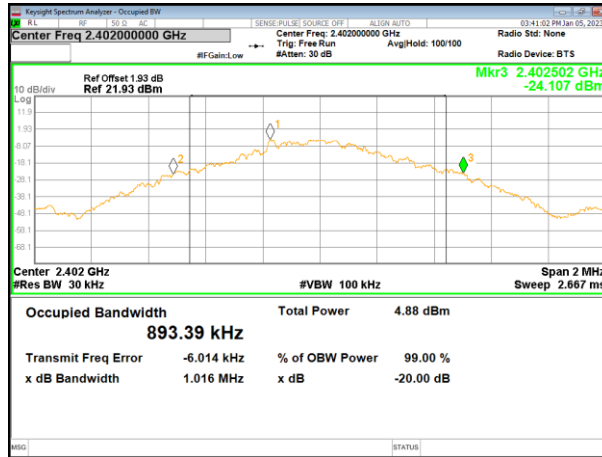

Lowest channel

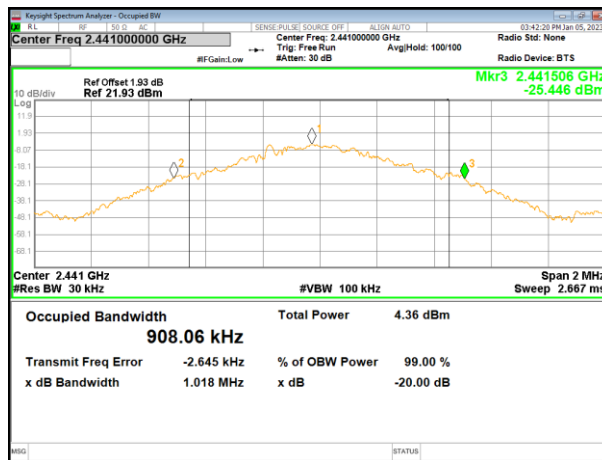

Middle channel

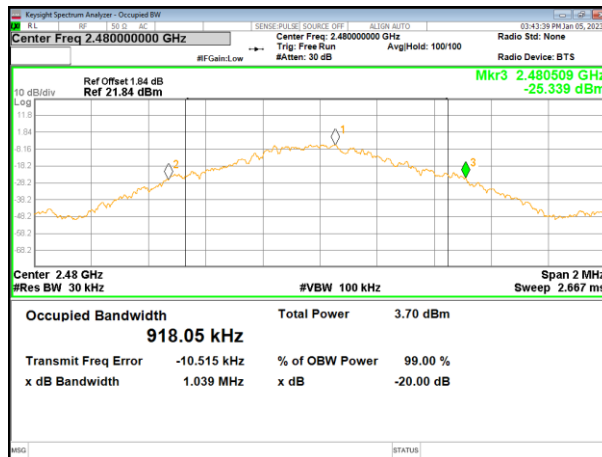

Highest channel

Test mode: $\pi/4$ -DQPSK mode

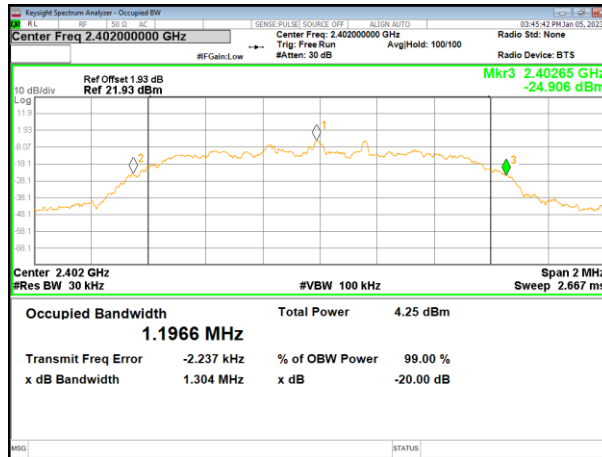

Lowest channel

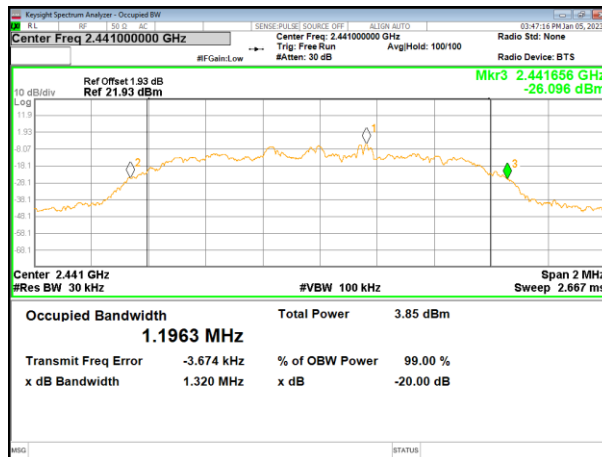

Middle channel

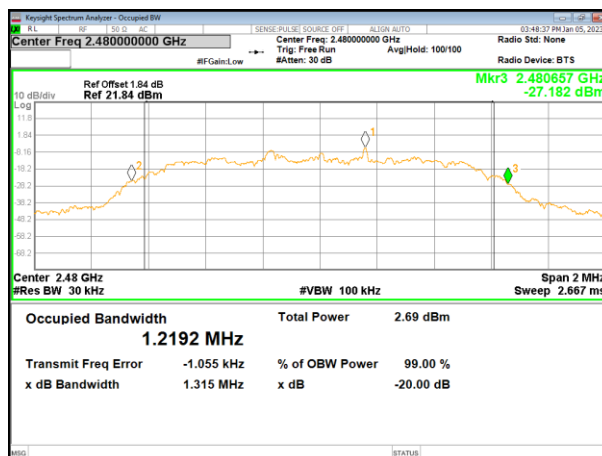

Highest channel

Test mode: 8-DPSK mode

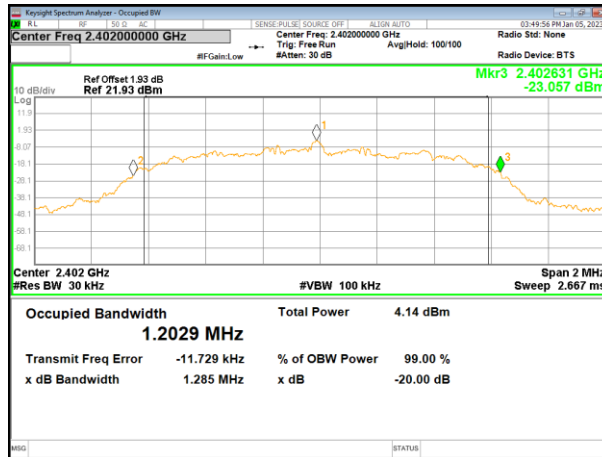

Lowest channel

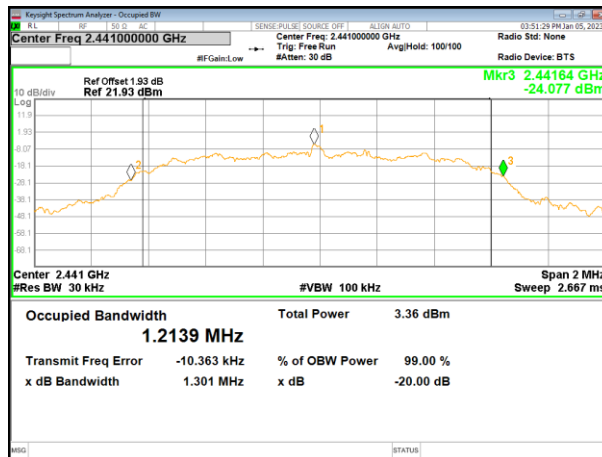

Middle channel

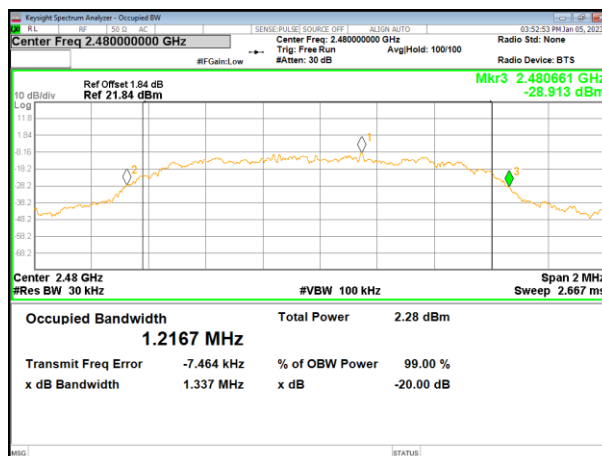

Highest channel

4.5 Carrier Frequencies Separation

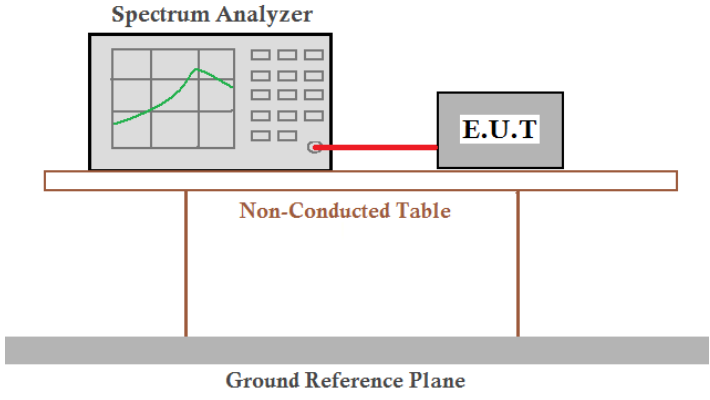
Test Requirement:	FCC Part15 C Section 15.247 (a)(1)
Test Method:	ANSI C63.10:2013
Receiver setup:	RBW=30KHz, VBW=100KHz, detector=Peak
Limit:	>0.025MHz or 2/3 of the 20dB bandwidth (whichever is greater)
Test setup:	
Test Instruments:	Refer to section 3.0 for details
Test mode:	Refer to section 2.2 for details
Test results:	Pass

Measurement Data

Mode	Test channel	Carrier Frequencies Separation (MHz)	Limit (MHz)	Result
GFSK	Lowest	1.0350	0.6773	Pass
	Middle	1.0485	0.6787	Pass
	Highest	1.0755	0.6927	Pass
$\pi/4$ -DQPSK	Lowest	0.9735	0.8693	Pass
	Middle	1.0755	0.8800	Pass
	Highest	1.0965	0.8767	Pass
8-DPSK	Lowest	1.1850	0.8567	Pass
	Middle	1.1835	0.8673	Pass
	Highest	1.1520	0.8913	Pass

Note: According to section 4.4

Test plot as follows:

Modulation mode: **GFSK**

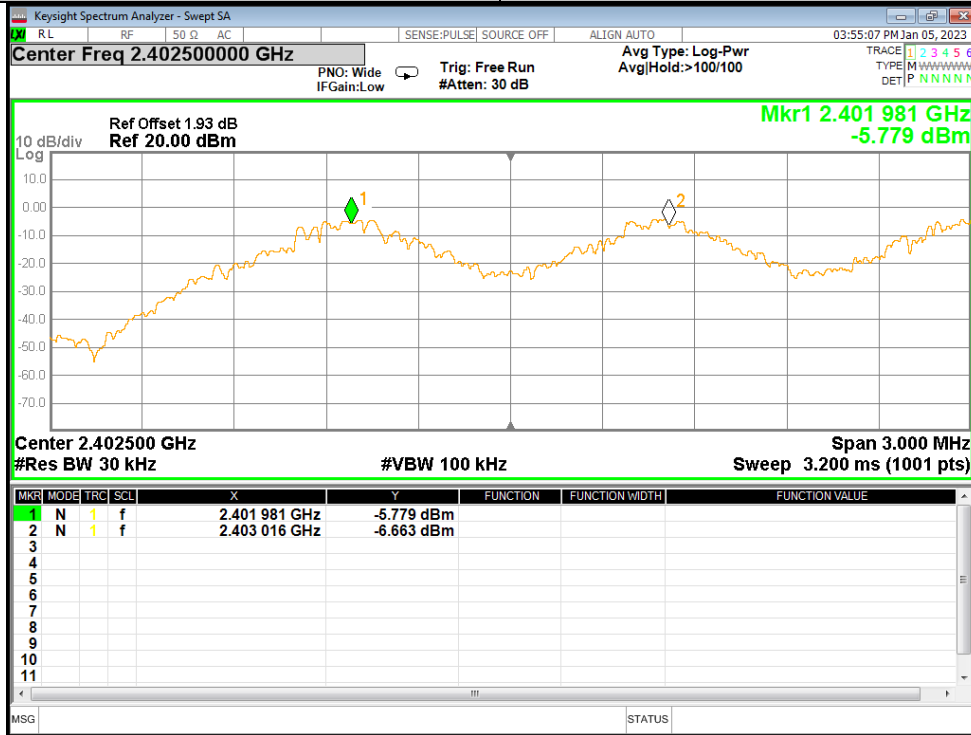

Lowest channel

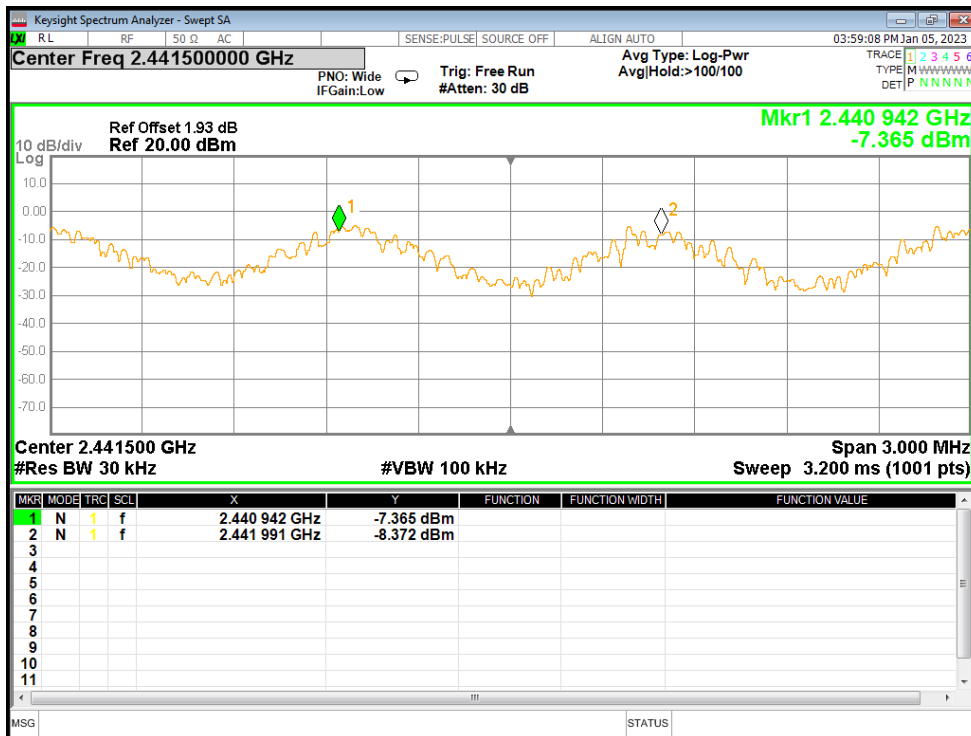

Middle channel

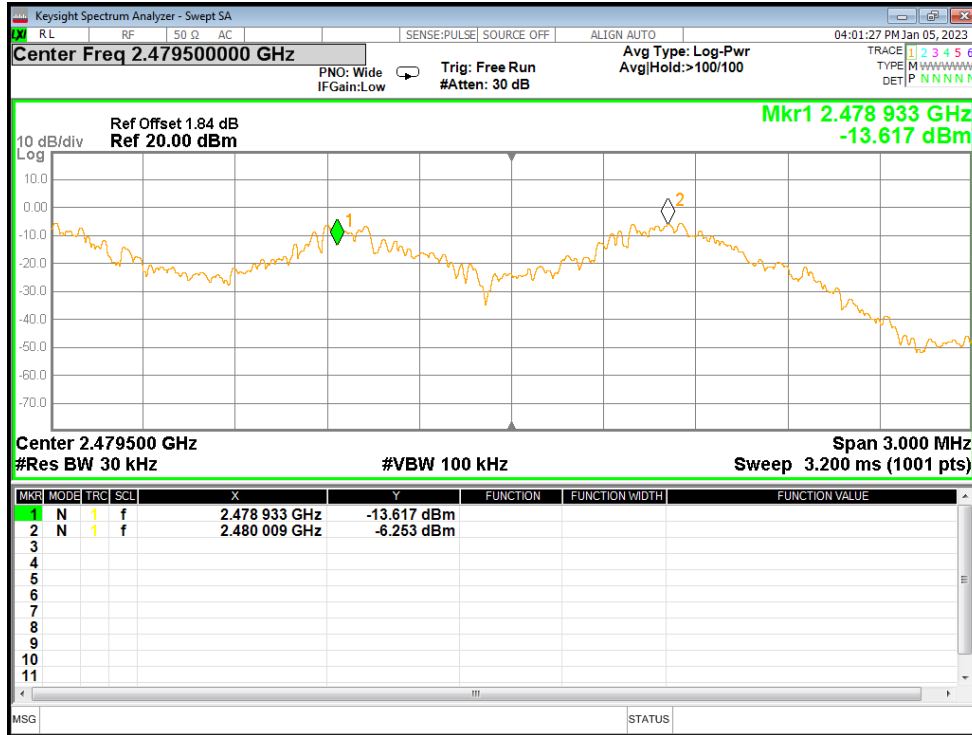

Highest channel

Test mode: $\pi/4$ -DQPSK

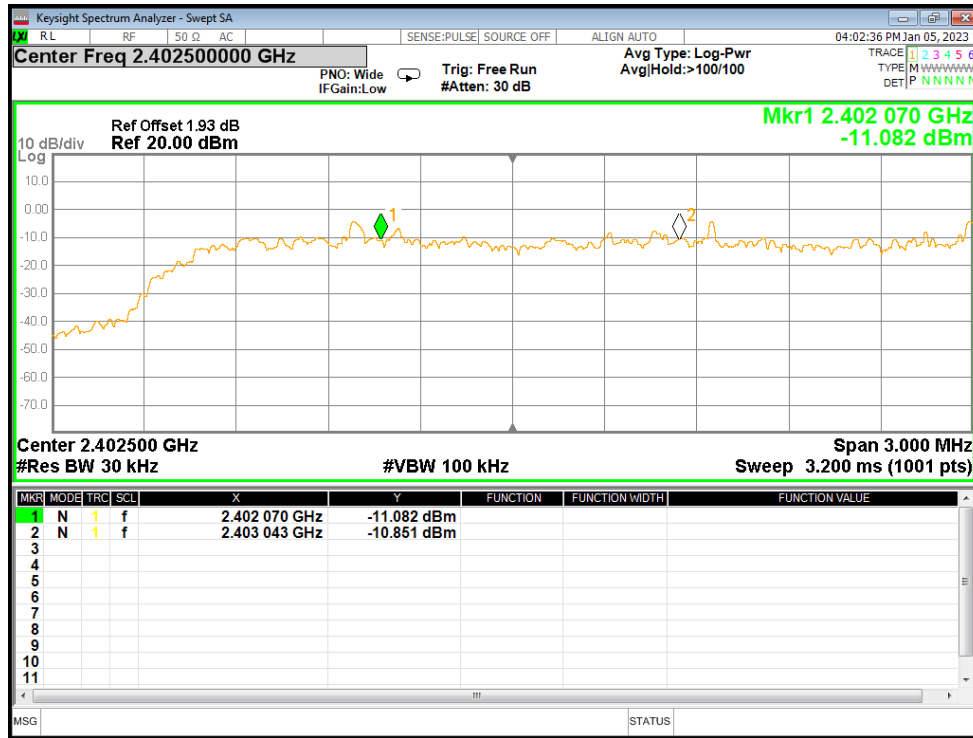

Lowest channel

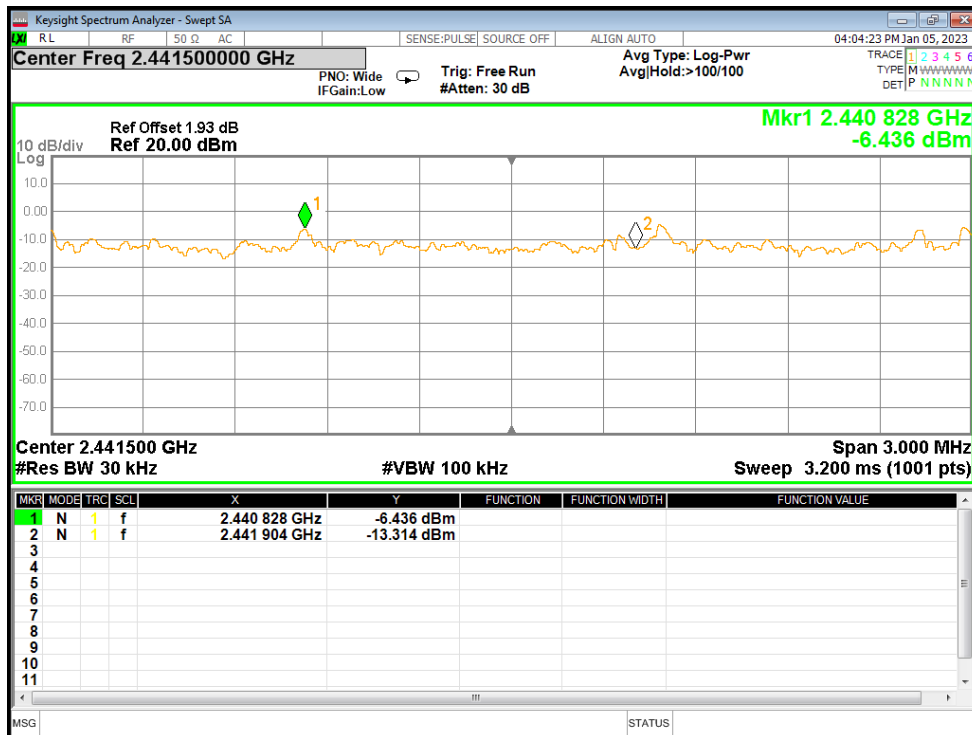

Middle channel

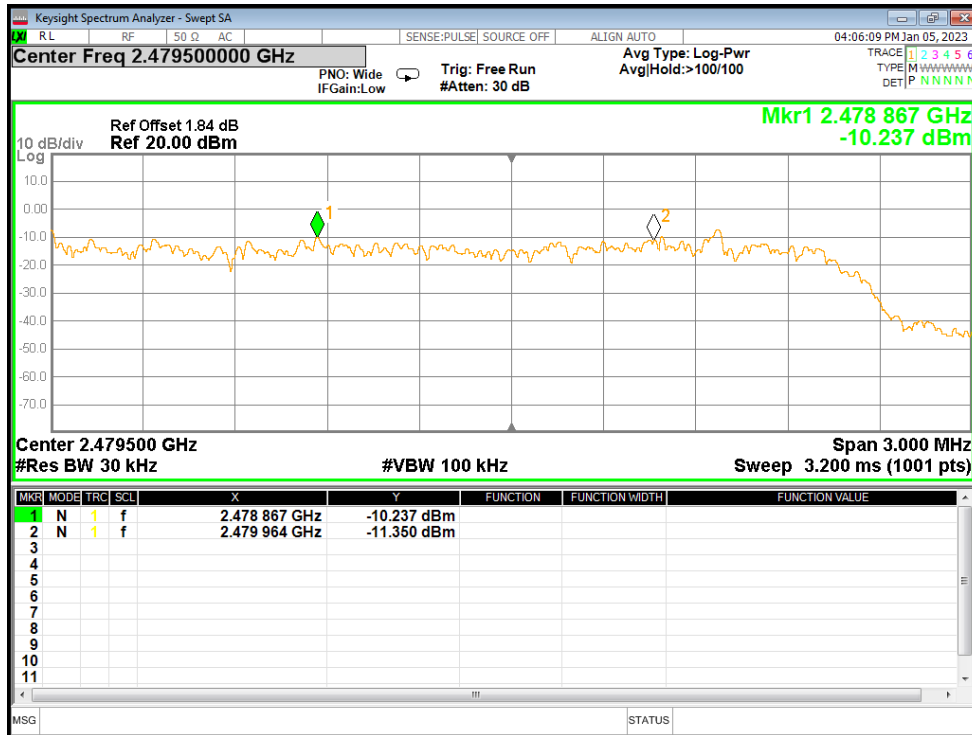

Highest channel

Test mode: **8-DPSK**

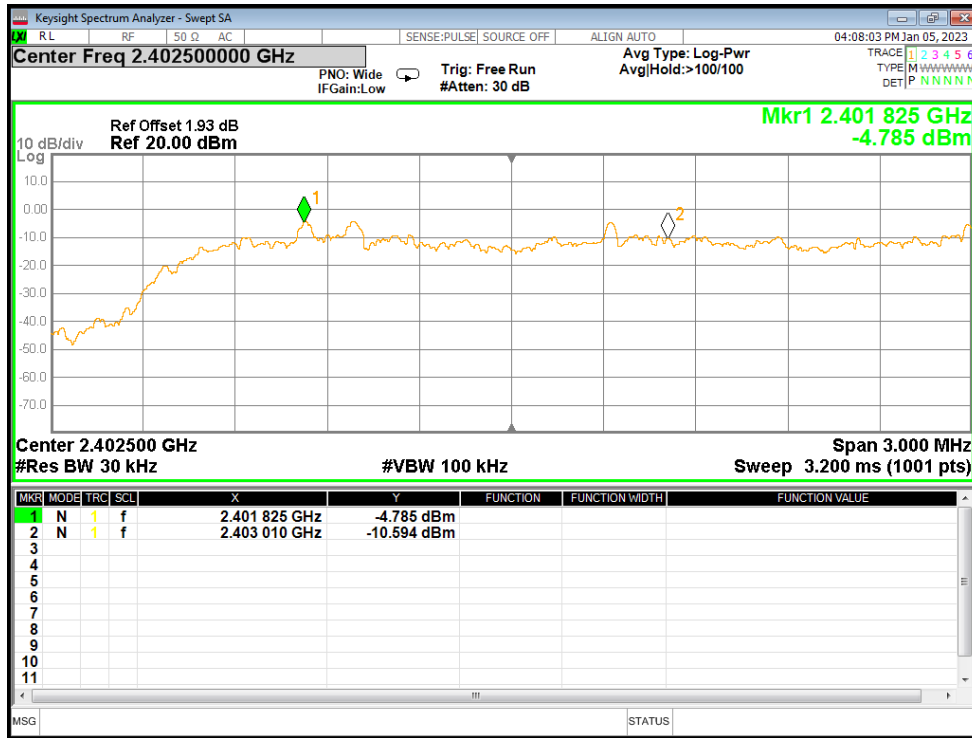

Lowest channel

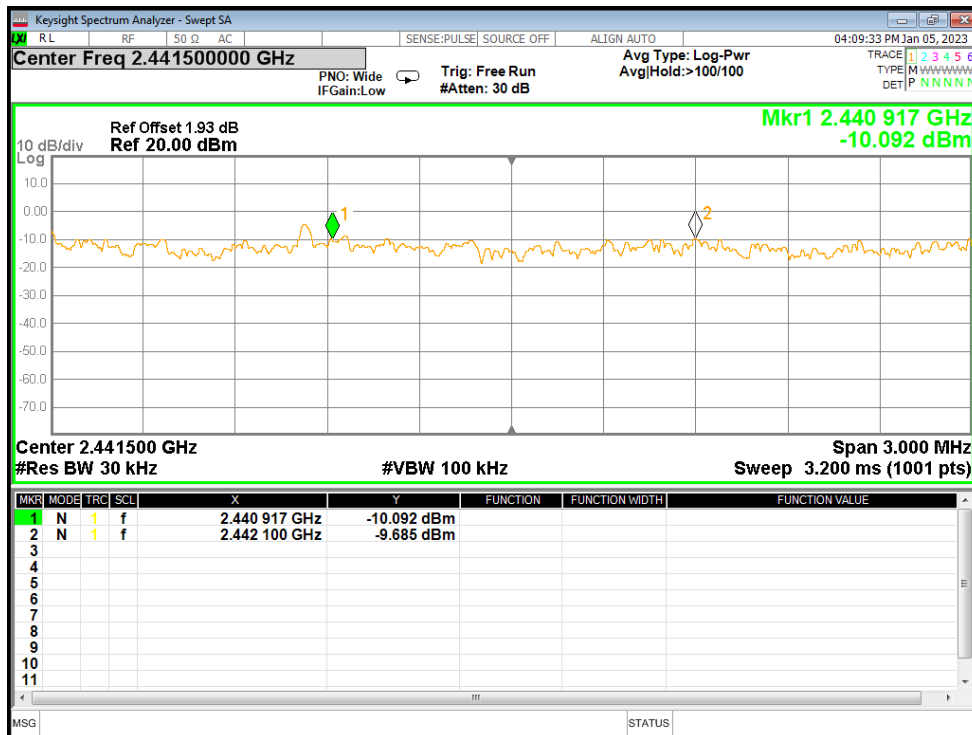

Middle channel

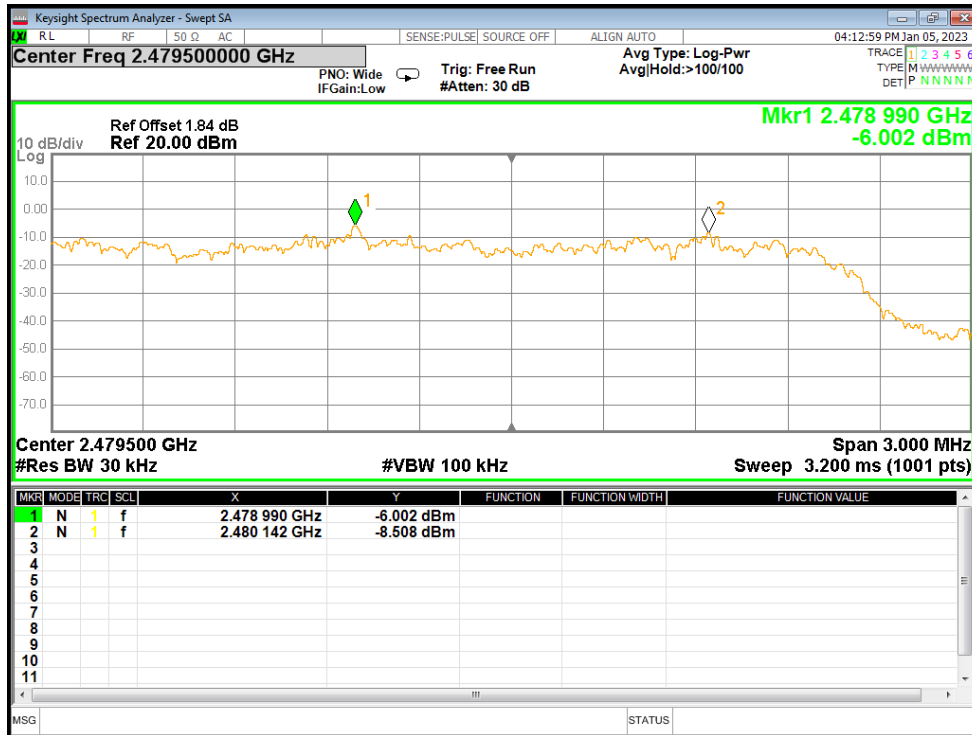

Highest channel

4.6 Hopping Channel Number

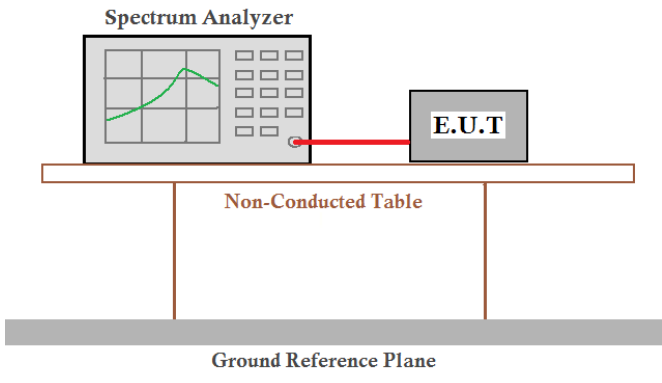
Test Requirement:	FCC Part15 C Section 15.247 (a)(1)(iii)
Test Method:	ANSI C63.10:2013
Receiver setup:	RBW=100kHz, VBW=300kHz, Frequency range=2400MHz-2483.5MHz, Detector=Peak
Limit:	15 channels
Test setup:	 <p>The diagram illustrates the test setup. A Spectrum Analyzer is connected via a red cable to an E.U.T. (Equipment Under Test). Both are placed on a Non-Conducted Table. Below the table is a Ground Reference Plane.</p>
Test Instruments:	Refer to section 3.0 for details
Test mode:	Refer to section 2.2 for details
Test results:	Pass

Measurement Data:

Mode	Hopping channel numbers	Limit	Result
GFSK	79	15	Pass
$\pi/4$ -DQPSK	79	15	Pass
8-DPSK	79	15	Pass

Test plot as follows:

Test mode: GFSK

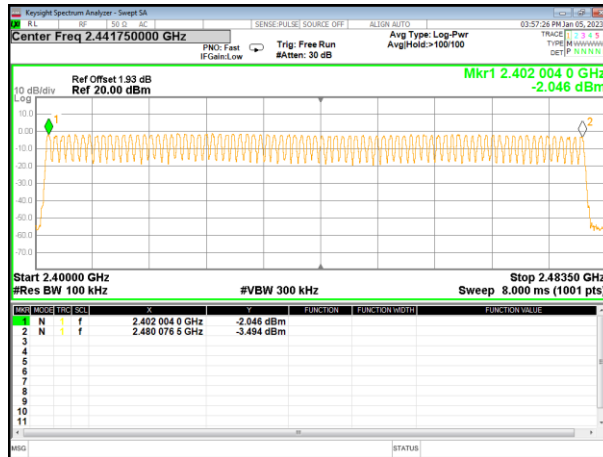

Test mode: $\pi/4$ -DQPSK

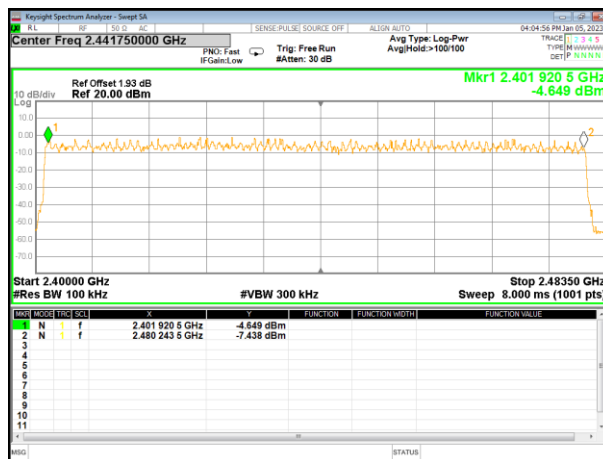

Test mode: 8-DPSK

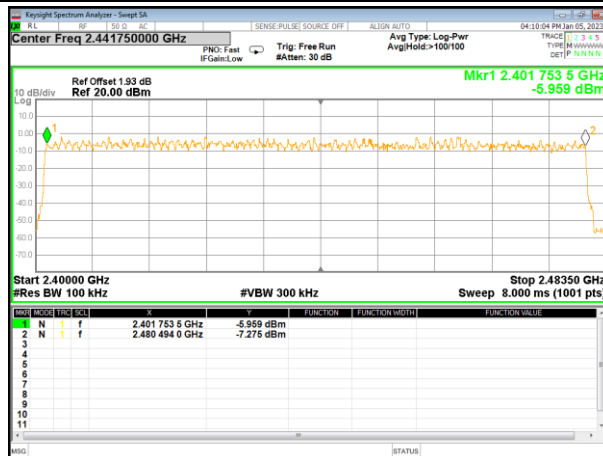

4.7 Dwell Time

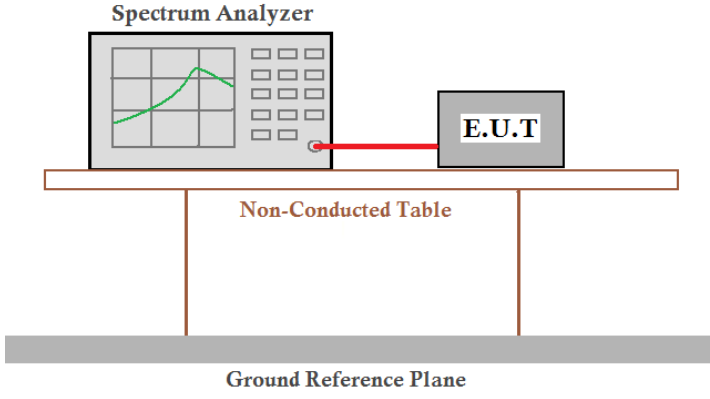
Test Requirement:	FCC Part15 C Section 15.247 (a)(1)(iii)
Test Method:	ANSI C63.10:2013
Receiver setup:	RBW=1MHz, VBW=3MHz, Span=0Hz, Detector=Peak
Limit:	0.4 Second
Test setup:	 <p>The diagram illustrates the test setup. A Spectrum Analyzer is connected via a red cable to an E.U.T. (Equipment Under Test). Both are placed on a Non-Conducted Table. Below the table is a Ground Reference Plane.</p>
Test Instruments:	Refer to section 3.0 for details
Test mode:	Refer to section 2.2 for details
Test results:	Pass

Measurement Data

GFSK mode:

Frequency	Packet	Dwell time(ms)	Limit(ms)	Result
2441MHz	DH1	120.32	400	Pass
2441MHz	DH3	260.96	400	Pass
2441MHz	DH5	307.09	400	Pass

Remarks:

The test period: $T = 0.4 \text{ Second/Channel} \times 79 \text{ Channel} = 31.6 \text{ s}$

Test channel: 2441MHz as blow

DH1 time slot = $0.376(\text{ms}) \times (1600 / (2 \times 79)) \times 31.6 = 120.32\text{ms}$

DH3 time slot = $1.631(\text{ms}) \times (1600 / (4 \times 79)) \times 31.6 = 260.96\text{ms}$

DH5 time slot = $2.879(\text{ms}) \times (1600 / (6 \times 79)) \times 31.6 = 307.09\text{ms}$

$\pi/4$ -DQPSK mode:

Frequency	Packet	Dwell time(ms)	Limit(ms)	Result
2441MHz	DH1	123.52	400	Pass
2441MHz	DH3	261.92	400	Pass
2441MHz	DH5	307.84	400	Pass

Remarks:

The test period: $T = 0.4 \text{ Second/Channel} \times 79 \text{ Channel} = 31.6 \text{ s}$

Test channel: 2441MHz as blow

DH1 time slot = $0.386(\text{ms}) \times (1600 / (2 \times 79)) \times 31.6 = 123.52 \text{ ms}$

DH3 time slot = $1.637(\text{ms}) \times (1600 / (4 \times 79)) \times 31.6 = 261.60 \text{ ms}$

DH5 time slot = $2.886(\text{ms}) \times (1600 / (6 \times 79)) \times 31.6 = 307.84 \text{ ms}$

8-DPSK mode:

Frequency	Packet	Dwell time(ms)	Limit(ms)	Result
2441MHz	DH1	123.52	400	Pass
2441MHz	DH3	261.76	400	Pass
2441MHz	DH5	307.95	400	Pass

Remarks:

The test period: $T = 0.4 \text{ Second/Channel} \times 79 \text{ Channel} = 31.6 \text{ s}$

Test channel: 2441MHz as blow

DH1 time slot = $0.386(\text{ms}) \times (1600 / (2 \times 79)) \times 31.6 = 123.52\text{ms}$

DH3 time slot = $1.636(\text{ms}) \times (1600 / (4 \times 79)) \times 31.6 = 261.76\text{ms}$

DH5 time slot = $2.887(\text{ms}) \times (1600 / (6 \times 79)) \times 31.6 = 307.95\text{ms}$

Test plot as follows:

GFSK mode:

Test channel:	2441MHz
---------------	---------



DH1



DH3

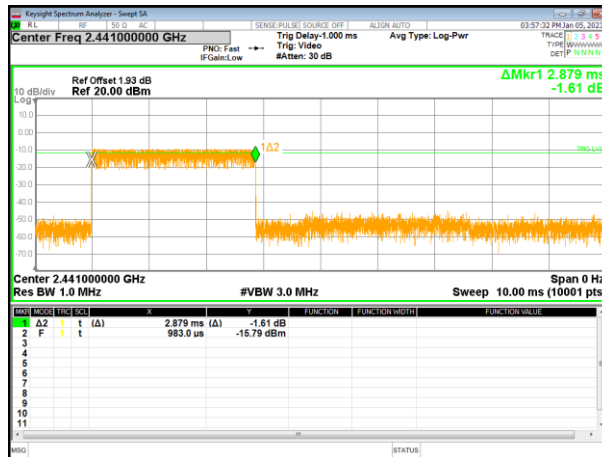

DH5

$\pi/4$ -DQPSK mode

Test channel:

2441MHz

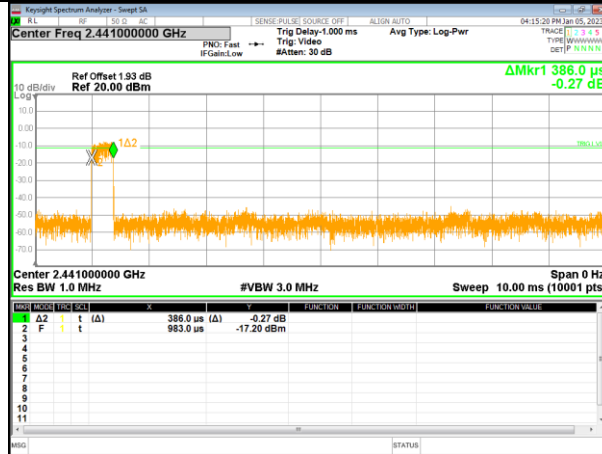

DH1

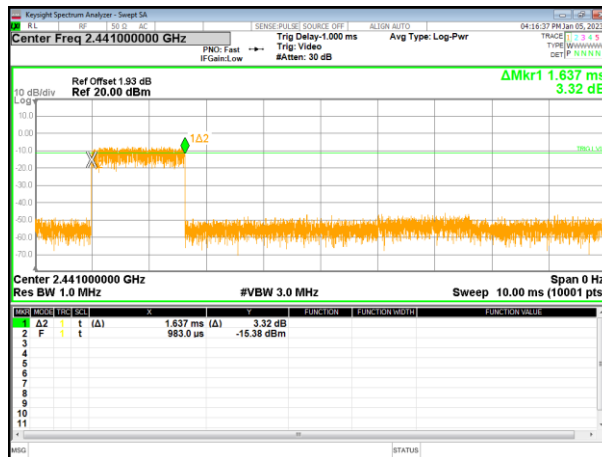

DH3

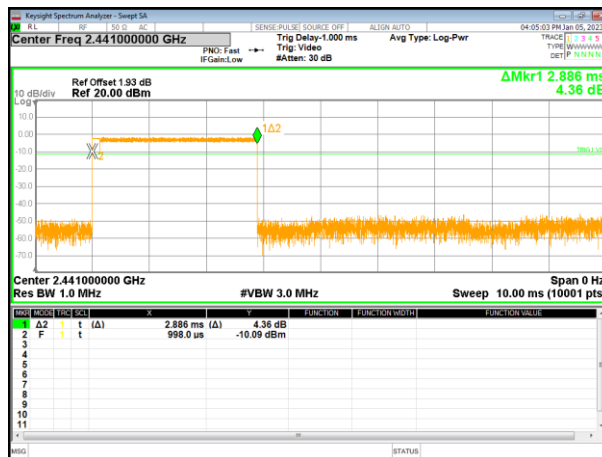

DH5

8-DPSK

Test channel:

2441MHz

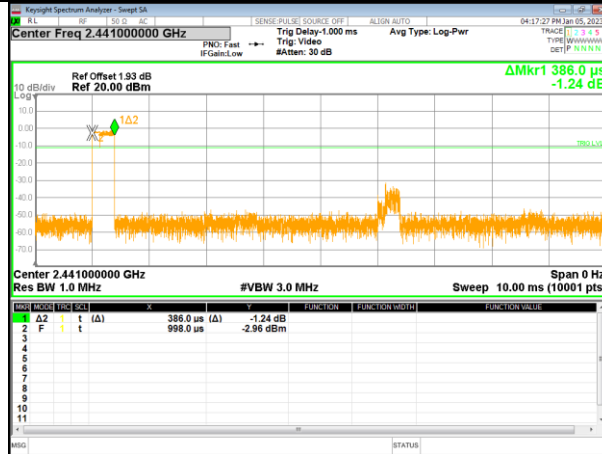

DH1



DH3



DH5

4.8 Band Edge

4.8.1 Conducted Emission Method

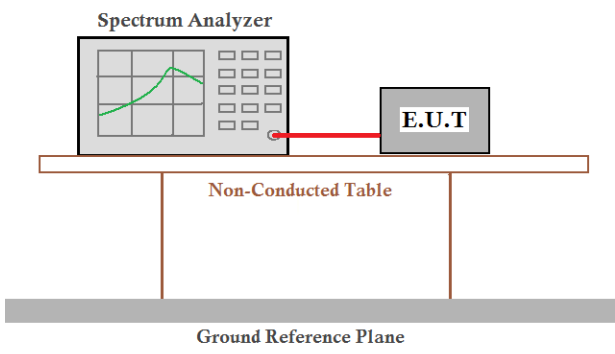
Test Requirement:	FCC Part15 C Section 15.247 (d)
Test Method:	ANSI C63.10:2013
Receiver setup:	RBW=100kHz, VBW=300kHz, Detector=Peak
Limit:	In any 100 kHz bandwidth outside the frequency band in which the spread spectrum intentional radiator is operating, the radio frequency power that is produced by the intentional radiator shall be at least 20 dB below that in the 100 kHz bandwidth within the band that contains the highest level of the desired power, based on either an RF conducted or a radiated measurement.
Test setup:	 <p>The diagram illustrates the test setup. A Spectrum Analyzer is connected to an E.U.T. (Equipment Under Test) via a red cable. Both the Spectrum Analyzer and the E.U.T. are placed on a Non-Conducted Table. The table is supported by a Ground Reference Plane.</p>
Test Instruments:	Refer to section 3.0 for details
Test mode:	Refer to section 2.2 for details
Test results:	Pass

Test plot as follows:

GFSK Mode:

Test channel: Lowest channel

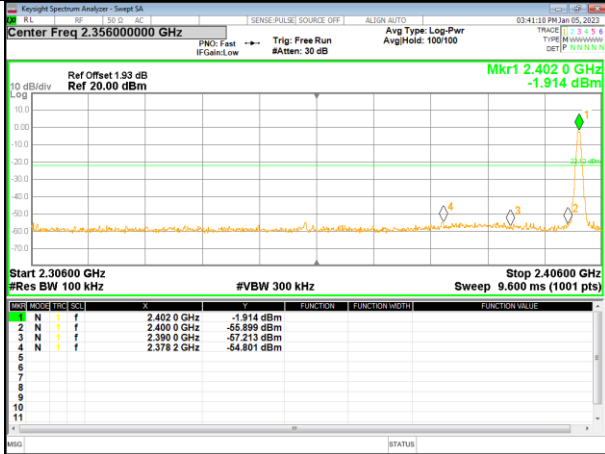

No-hopping mode

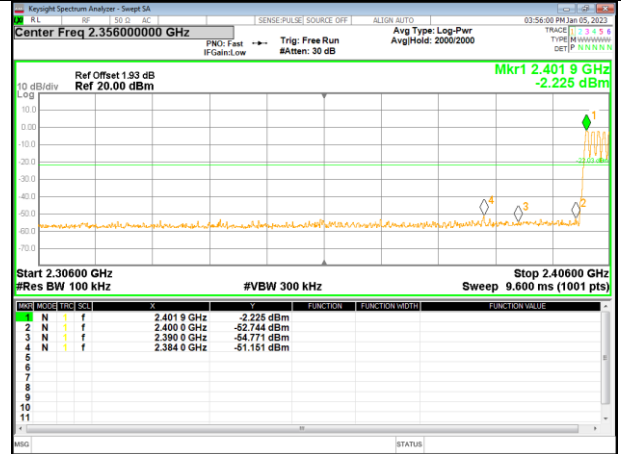

Hopping mode

Test channel: Highest channel

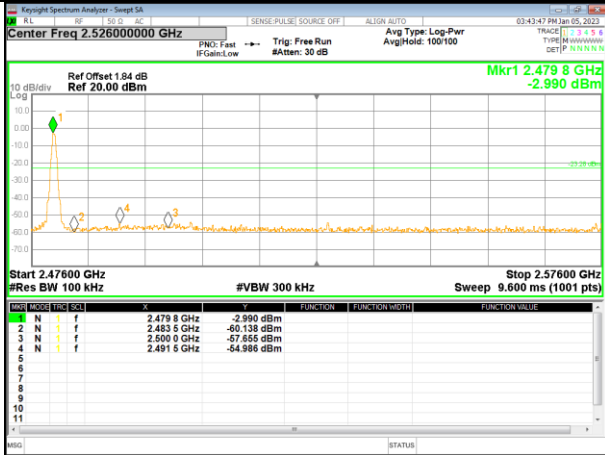

No-hopping mode

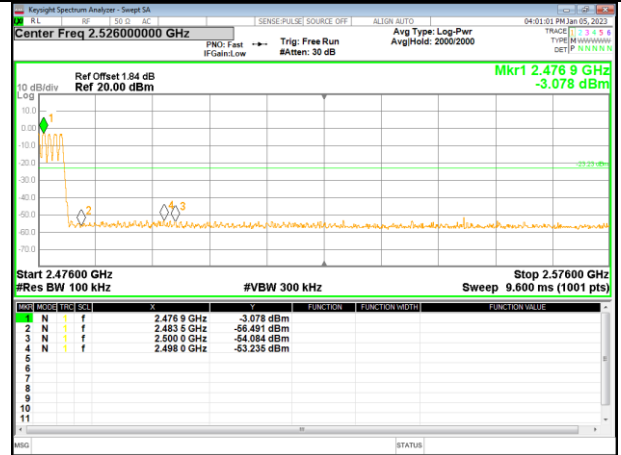

Hopping mode

$\pi/4$ -DQPSK Mode:

Test channel: Lowest channel

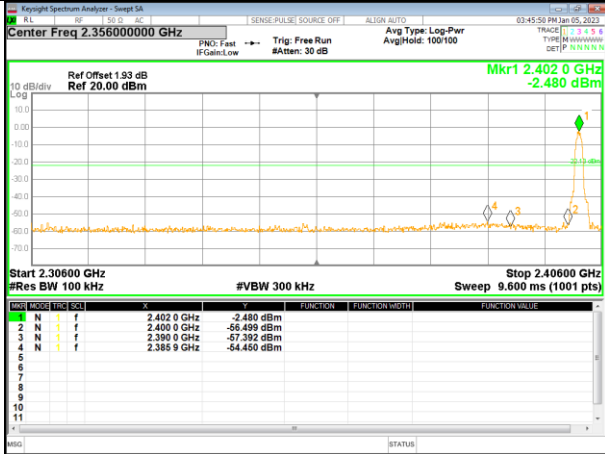

No-hopping mode

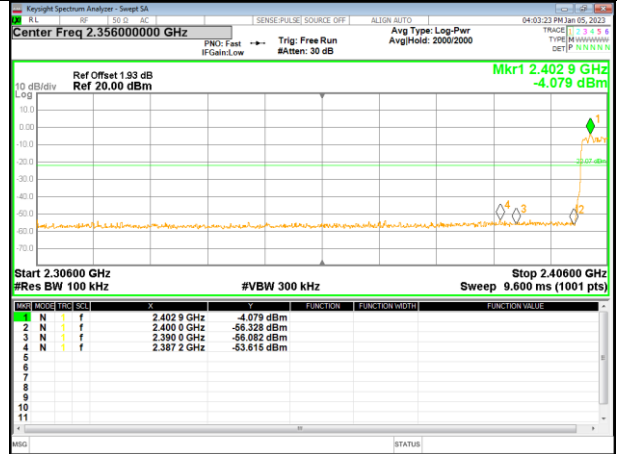

Hopping mode

Test channel: Highest channel

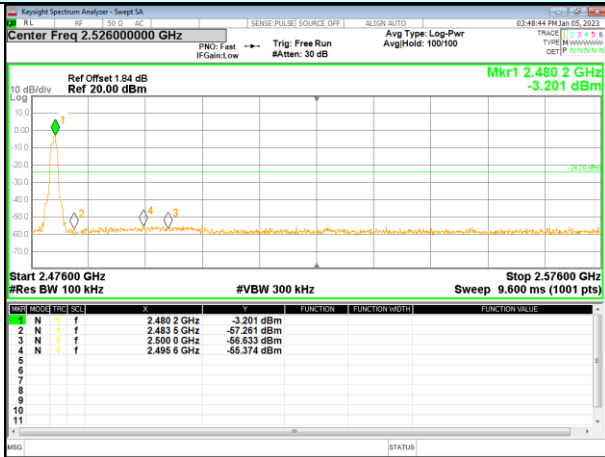

No-hopping mode

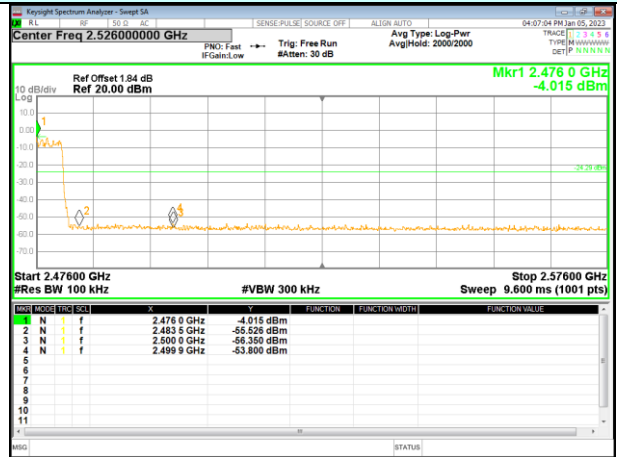

Hopping mode

8-DPSK Mode:

Test channel: Lowest channel

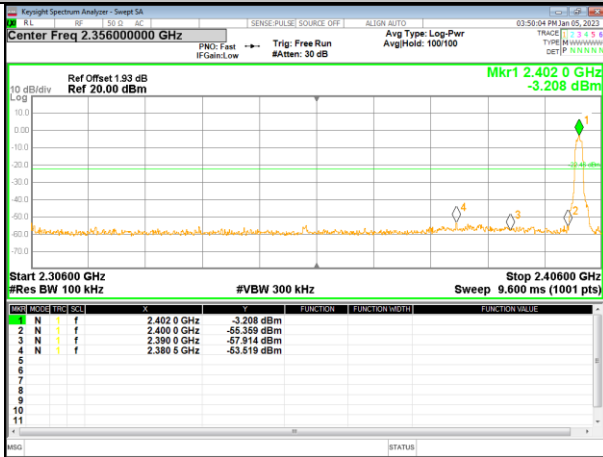

No-hopping mode

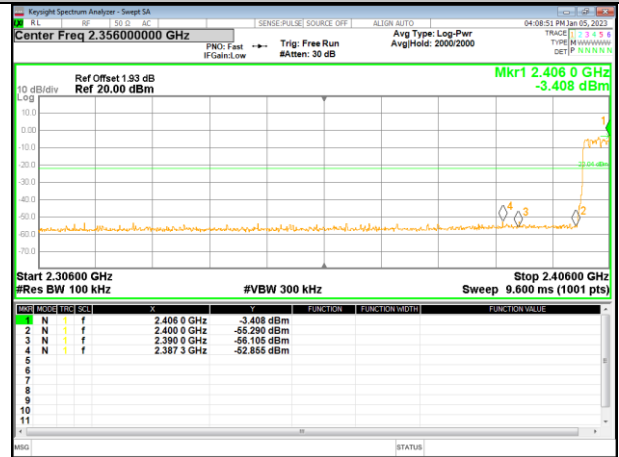

Hopping mode

Test channel: Highest channel

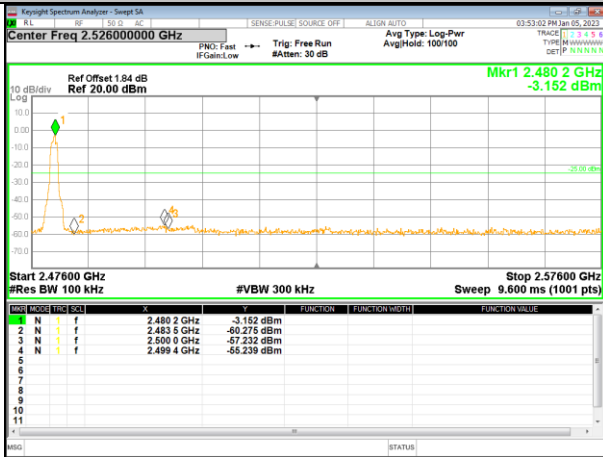

No-hopping mode

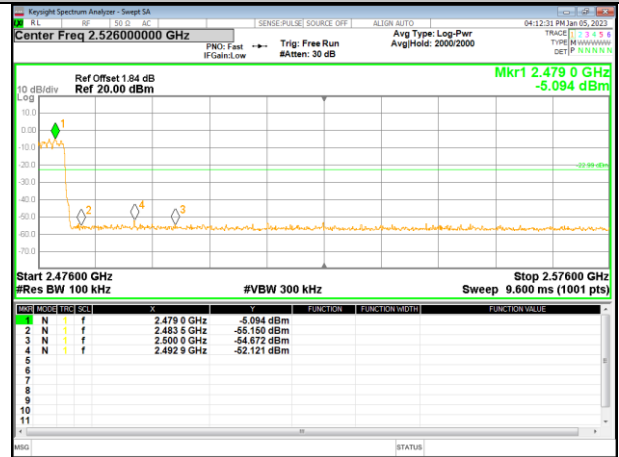

Hopping mode

4.8.2 Radiated Emission Method

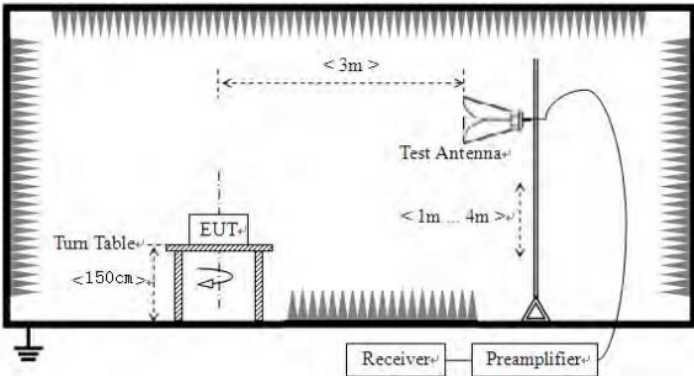
Test Requirement:	FCC Part15 C Section 15.209 and 15.205				
Test Method:	ANSI C63.10:2013				
Test Frequency Range:	All of the restrict bands were tested, only the worst band's (2310MHz to 2500MHz) data was showed.				
Test site:	Measurement Distance: 3m				
Receiver setup:	Frequency	Detector	RBW	VBW	Remark
	Above 1GHz	Peak	1MHz	3MHz	Peak Value
		Peak	1MHz	10Hz	Average Value
Limit:	Frequency		Limit (dBuV/m @3m)		Remark
	Above 1GHz		54.00		Average Value
			74.00		Peak Value
Test setup:					
Test Procedure:	<ol style="list-style-type: none"> 1. The EUT was placed on the top of a rotating table 1.5 meters above the ground at a 3 meter camber. The table was rotated 360 degrees to determine the position of the highest radiation. 2. The EUT was set 3 meters away from the interference-receiving antenna, which was mounted on the top of a variable-height antenna tower. 3. The antenna height is varied from one meter to four meters above the ground to determine the maximum value of the field strength. Both horizontal and vertical polarizations of the antenna are set to make the measurement. 4. For each suspected emission, the EUT was arranged to its worst case and then the antenna was tuned to heights from 1 meter to 4 meters and the rota table was turned from 0 degrees to 360 degrees to find the maximum reading. 5. The test-receiver system was set to Peak Detect Function and Specified Bandwidth with Maximum Hold Mode. 6. If the emission level of the EUT in peak mode was 10dB lower than the limit specified, then testing could be stopped and the peak values of the EUT would be reported. Otherwise the emissions that did not have 10dB margin would be re-tested one by one using peak, quasi-peak or average method as specified and then reported in a data sheet. 				
Test Instruments:	Refer to section 3.0 for details				
Test mode:	Refer to section 2.2 for details				
Test results:	Pass				

Measurement Data

Test channel:	Lowest
---------------	--------

Peak value:

Frequency (MHz)	Read Level (dBuV)	Antenna Factor (dB/m)	Cable Loss (dB)	Preamp Factor (dB)	Level (dBuV/m)	Limit Line (dBuV/m)	Over Limit (dB)	Polarization
2310.00	74.59	27.40	3.41	45.40	60.00	74.00	-14.00	Horizontal
2390.00	78.86	27.10	3.43	45.40	63.99	74.00	-10.01	Horizontal
2400.00	78.64	27.10	3.43	45.40	63.77	74.00	-10.23	Horizontal
2310.00	75.50	27.40	3.41	45.40	60.91	74.00	-13.09	Vertical
2390.00	77.76	27.10	3.43	45.40	62.89	74.00	-11.11	Vertical
2400.00	78.67	27.10	3.43	45.40	63.80	74.00	-10.20	Vertical

Average value:

Frequency (MHz)	Read Level (dBuV)	Antenna Factor (dB/m)	Cable Loss (dB)	Preamp Factor (dB)	Level (dBuV/m)	Limit Line (dBuV/m)	Over Limit (dB)	Polarization
2310.00	54.80	27.40	3.41	45.40	40.21	54.00	-13.79	Horizontal
2390.00	58.87	27.10	3.43	45.40	44.00	54.00	-10.00	Horizontal
2400.00	61.03	27.10	3.43	45.40	46.16	54.00	-7.84	Horizontal
2310.00	55.56	27.40	3.41	45.40	40.97	54.00	-13.03	Vertical
2390.00	58.55	27.10	3.43	45.40	43.68	54.00	-10.32	Vertical
2400.00	61.19	27.10	3.43	45.40	46.32	54.00	-7.68	Vertical

Test channel:	Highest
---------------	---------

Peak value:

Frequency (MHz)	Read Level (dBuV)	Antenna Factor (dB/m)	Cable Loss (dB)	Preamp Factor (dB)	Level (dBuV/m)	Limit Line (dBuV/m)	Over Limit (dB)	Polarization
2483.50	71.48	27.80	3.56	45.40	57.44	74.00	-16.56	Horizontal
2500.00	67.98	27.80	3.56	45.40	53.94	74.00	-20.06	Horizontal
2483.50	71.66	27.80	3.56	45.40	57.62	74.00	-16.38	Vertical
2500.00	67.60	27.80	3.56	45.40	53.56	74.00	-20.44	Vertical

Average value:

Frequency (MHz)	Read Level (dBuV)	Antenna Factor (dB/m)	Cable Loss (dB)	Preamp Factor (dB)	Level (dBuV/m)	Limit Line (dBuV/m)	Over Limit (dB)	Polarization
2483.50	59.77	27.80	3.56	45.40	45.73	54.00	-8.27	Horizontal
2500.00	57.12	27.80	3.56	45.40	43.08	54.00	-10.92	Horizontal
2483.50	60.53	27.80	3.56	45.40	46.49	54.00	-7.51	Vertical
2500.00	56.93	27.80	3.56	45.40	42.89	54.00	-11.11	Vertical

Remarks:

1. Final Level = Receiver Read level + Antenna Factor + Cable Loss – Pre-amplifier Factor
2. The emission levels of other frequencies are very lower than the limit and not show in test report.
3. The pre-test were performed on lowest, middle and highest frequencies, only the worst case's (lowest and highest frequencies) data was showed.
4. During the test, pre-scan the GFSK, π/4-DQPSK, 8-DPSK modulation, and found the 8-DPSK modulation which it is worse case.

4.9 Spurious Emission

4.9.1 Conducted Emission Method

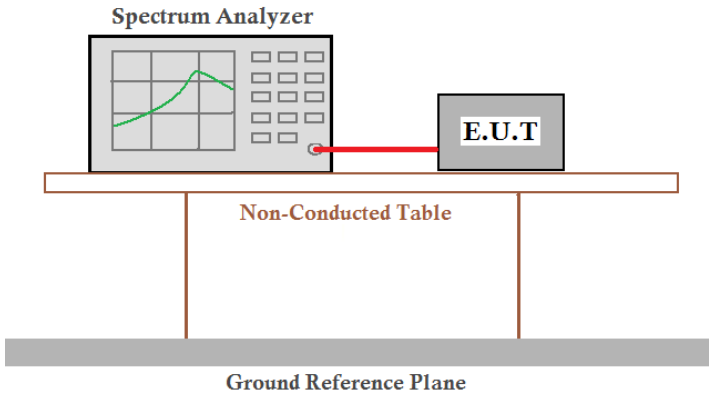
Test Requirement:	FCC Part15 C Section 15.247 (d)
Test Method:	ANSI C63.10:2013
Limit:	In any 100 kHz bandwidth outside the frequency band in which the spread spectrum intentional radiator is operating, the radio frequency power that is produced by the intentional radiator shall be at least 20 dB below that in the 100 kHz bandwidth within the band that contains the highest level of the desired power, based on either an RF conducted or a radiated measurement.
Test setup:	 <p>The diagram illustrates the test setup. A Spectrum Analyzer is connected to an E.U.T. (Equipment Under Test) via a red cable. Both the Spectrum Analyzer and the E.U.T. are placed on a Non-Conducted Table. The table is supported by two legs and sits on a Ground Reference Plane.</p>
Test Instruments:	Refer to section 3.0 for details
Test mode:	Refer to section 2.2 for details
Test results:	Pass

GFSK mode:

Test channel: Lowest channel

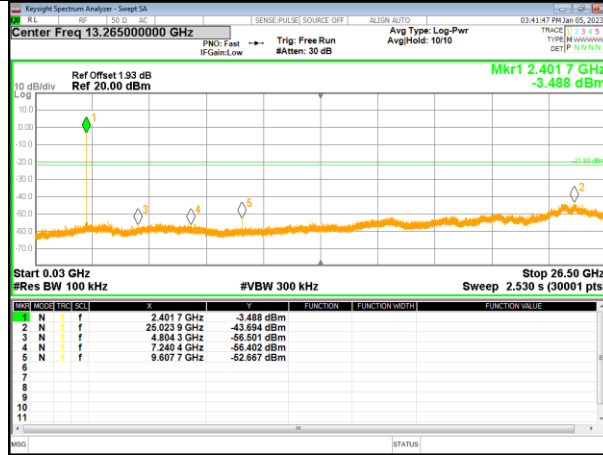

30MHz~25GHz

Test channel: Middle channel

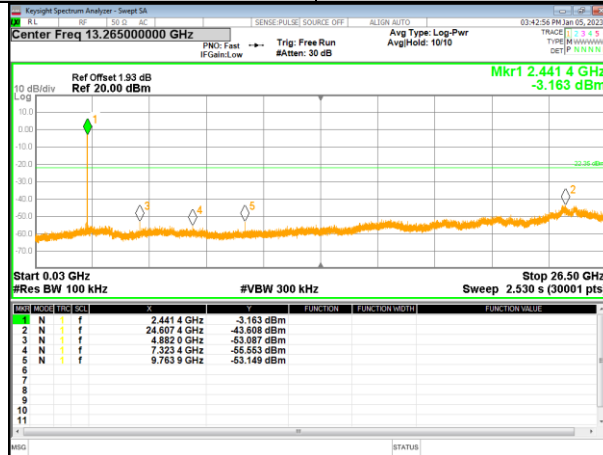

30MHz~25GHz

Test channel: Highest channel

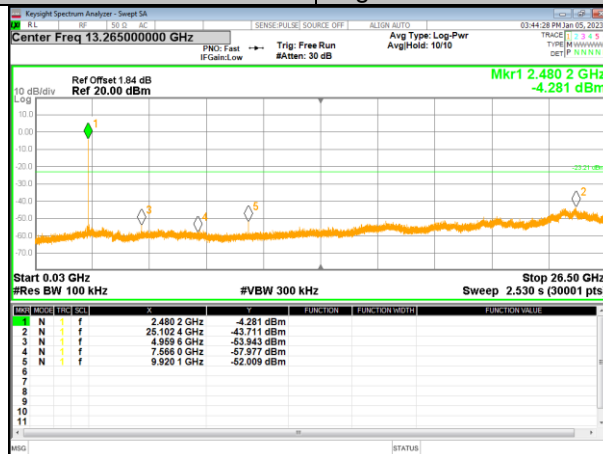

30MHz~25GHz

$\pi/4$ -DQPSK mode:

Test channel: Lowest channel

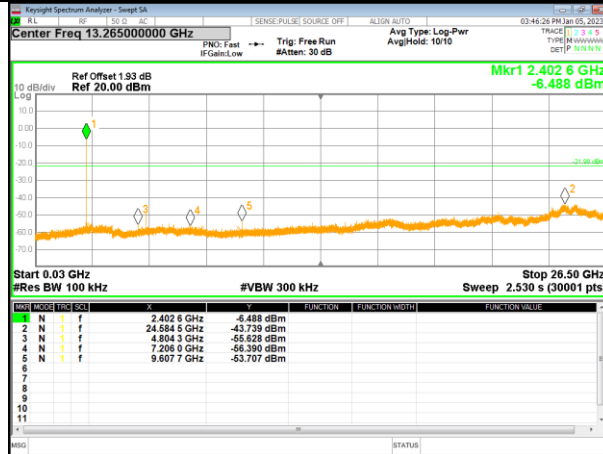

30MHz~25GHz

Test channel: Middle channel

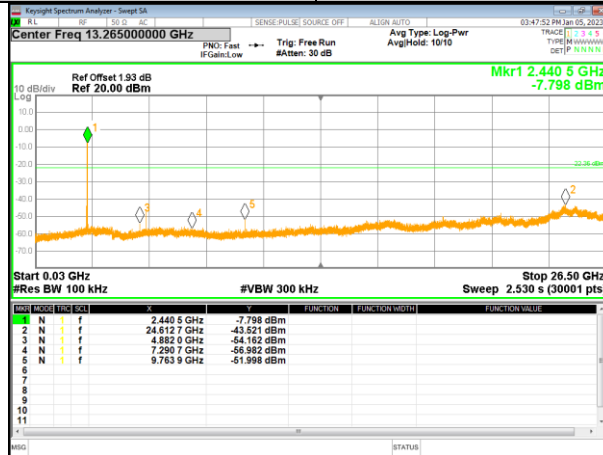

30MHz~25GHz

Test channel: Highest channel

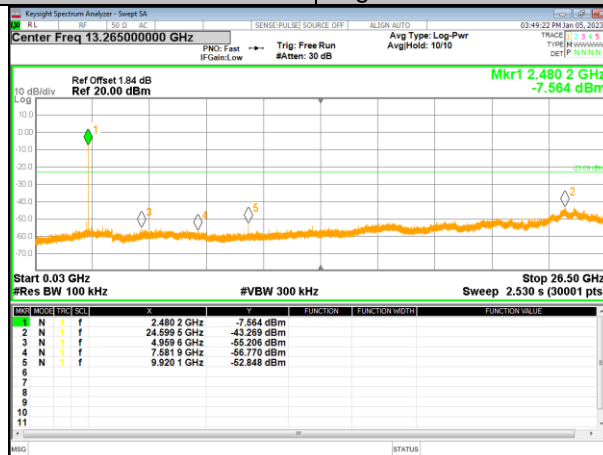

30MHz~25GHz

8-DPSK mode:

Test channel: Lowest channel

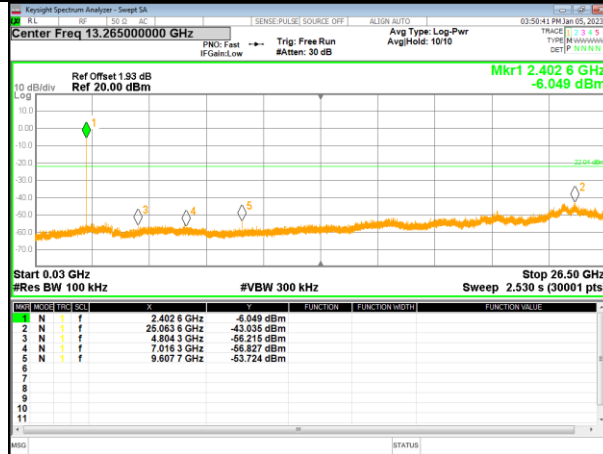

30MHz~25GHz

Test channel: Middle channel

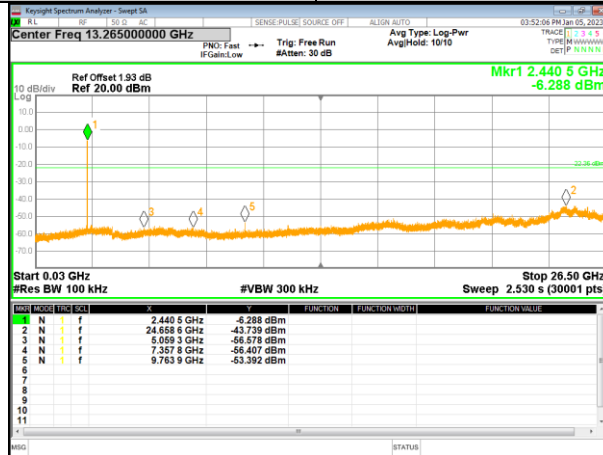

30MHz~25GHz

Test channel: Highest channel

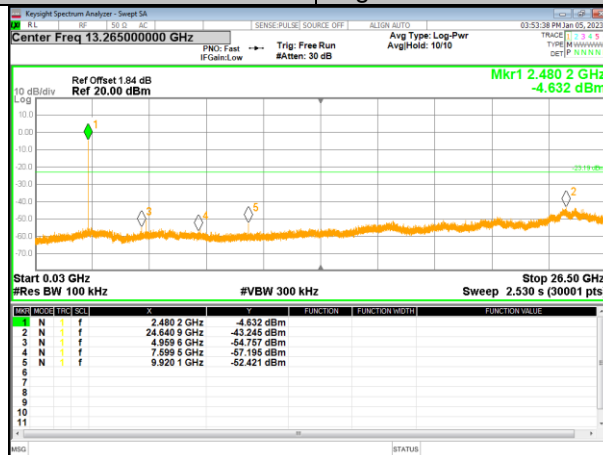

30MHz~25GHz

4.9.2 Radiated Emission Method

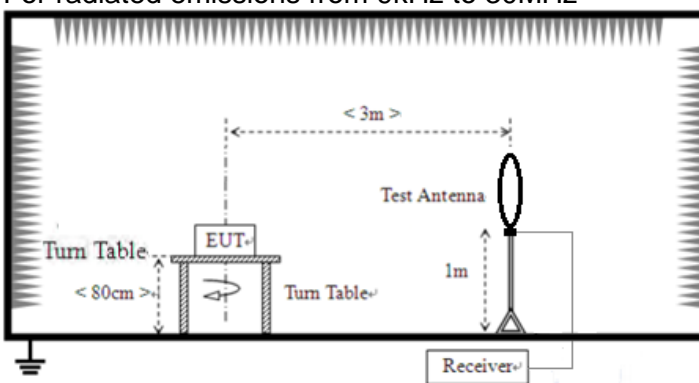
Test Requirement:	FCC Part15 C Section 15.209				
Test Method:	ANSI C63.10:2013				
Test Frequency Range:	9kHz to 25GHz				
Test site:	Measurement Distance: 3m				
Receiver setup:	Frequency	Detector	RBW	VBW	Value
	9KHz-150KHz	Quasi-peak	200Hz	600Hz	Quasi-peak
	150KHz-30MHz	Quasi-peak	9KHz	30KHz	Quasi-peak
	30MHz-1GHz	Quasi-peak	120KHz	300KHz	Quasi-peak
	Above 1GHz	Peak	1MHz	3MHz	Peak
Peak		1MHz	10Hz	Average	
Limit:	Frequency	Limit (uV/m)	Value	Measurement Distance	
	0.009MHz-0.490MHz	2400/F(KHz)	QP	300m	
	0.490MHz-1.705MHz	24000/F(KHz)	QP	30m	
	1.705MHz-30MHz	30	QP	30m	
	30MHz-88MHz	100	QP	3m	
	88MHz-216MHz	150	QP		
	216MHz-960MHz	200	QP		
	960MHz-1GHz	500	QP		
	Above 1GHz	500	Average		
		5000	Peak		
Test setup:	For radiated emissions from 9kHz to 30MHz				
					

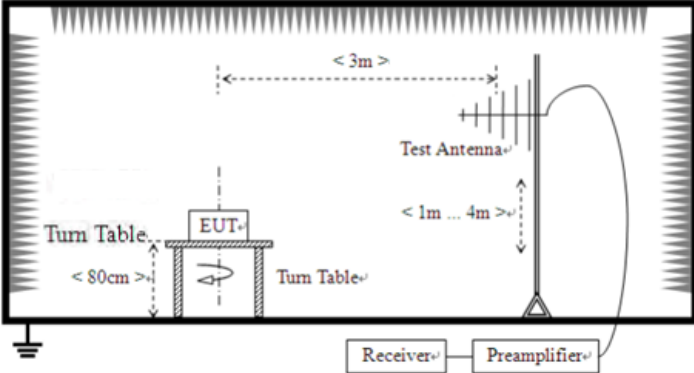
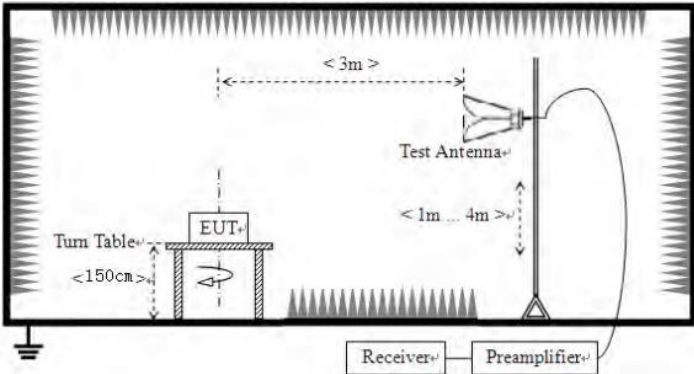
	<p>For radiated emissions from 30MHz to1GHz</p>  <p>For radiated emissions above 1GHz</p> 						
<p>Test Procedure:</p>	<ol style="list-style-type: none"> 1. The EUT was placed on the top of a rotating table (0.8m for below 1G and 1.5m for above 1G) above the ground at a 3 meter camber. The table was rotated 360 degrees to determine the position of the highest radiation. 2. The EUT was set 3 meters away from the interference-receiving antenna, which was mounted on the top of a variable-height antenna tower. 3. The antenna height is varied from one meter to four meters above the ground to determine the maximum value of the field strength. Both horizontal and vertical polarizations of the antenna are set to make the measurement. 4. For each suspected emission, the EUT was arranged to its worst case and then the antenna was tuned to heights from 1 meter to 4 meters and the rota table was turned from 0 degrees to 360 degrees to find the maximum reading. 5. The test-receiver system was set to Peak Detect Function and Specified Bandwidth with Maximum Hold Mode. 6. If the emission level of the EUT in peak mode was 10dB lower than the limit specified, then testing could be stopped and the peak values of the EUT would be reported. Otherwise the emissions that did not have 10dB margin would be re-tested one by one using peak, quasi-peak or average method as specified and then reported in a data sheet. 						
<p>Test Instruments:</p>	<p>Refer to section 3.0 for details</p>						
<p>Test mode:</p>	<p>Refer to section 2.2 for details</p>						
<p>Test environment:</p>	<table border="1"> <tr> <td>Temp.:</td> <td>25.6 °C</td> <td>Humid.:</td> <td>55%</td> <td>Press.:</td> <td>1012mbar</td> </tr> </table>	Temp.:	25.6 °C	Humid.:	55%	Press.:	1012mbar
Temp.:	25.6 °C	Humid.:	55%	Press.:	1012mbar		
<p>Test voltage:</p>	<p>DC 3.7V From battery</p>						

Test results:	Pass
---------------	------

Measurement data:

Remarks:

1. *During the test, pre-scan the GFSK, $\pi/4$ -DQPSK, 8-DPSK modulation, and found the 8-DPSK modulation which it is worse case.*
2. *Pre-scan all kind of the place mode (X-axis, Y-axis, Z-axis), and found the Y-axis which it is worse case.*

■ **9kHz~30MHz**

The low frequency, which started from 9 kHz to 30 MHz, was pre-scanned and the result which was 20 dB lower than the limit line per 15.31(o) was not reported.

■ **Below 1GHz**

Pre-scan all test modes, found worst case at 8-DPSK 2402MHz, and so only show the test result of 8-DPSK 2402MHz

Vertical:

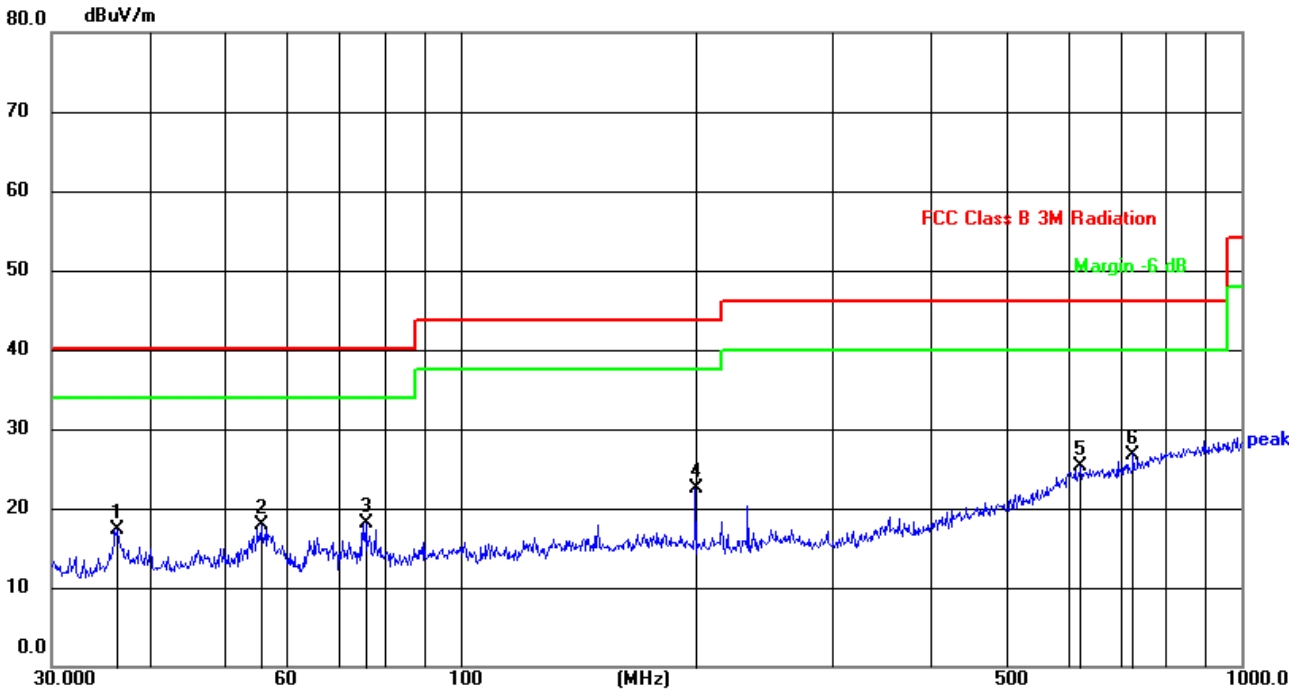

No.	Frequency (MHz)	Reading (dBuV)	Factor (dB/m)	Level (dBuV/m)	Limit (dBuV/m)	Margin (dB)	Detector
1	36.3814	38.36	-21.10	17.26	40.00	-22.74	QP
2	55.6094	38.79	-20.88	17.91	40.00	-22.09	QP
3	75.7114	38.63	-20.54	18.09	40.00	-21.91	QP
4	199.9856	41.12	-18.56	22.56	43.50	-20.94	QP
5	622.8900	34.98	-9.58	25.40	46.00	-20.60	QP
6	726.8052	35.40	-8.60	26.80	46.00	-19.20	QP

Level = Reading + Factor, Margin=level-Limit

Factor= Antenna Factor + Cable Loss – Preamplifier Factor

Horizontal:

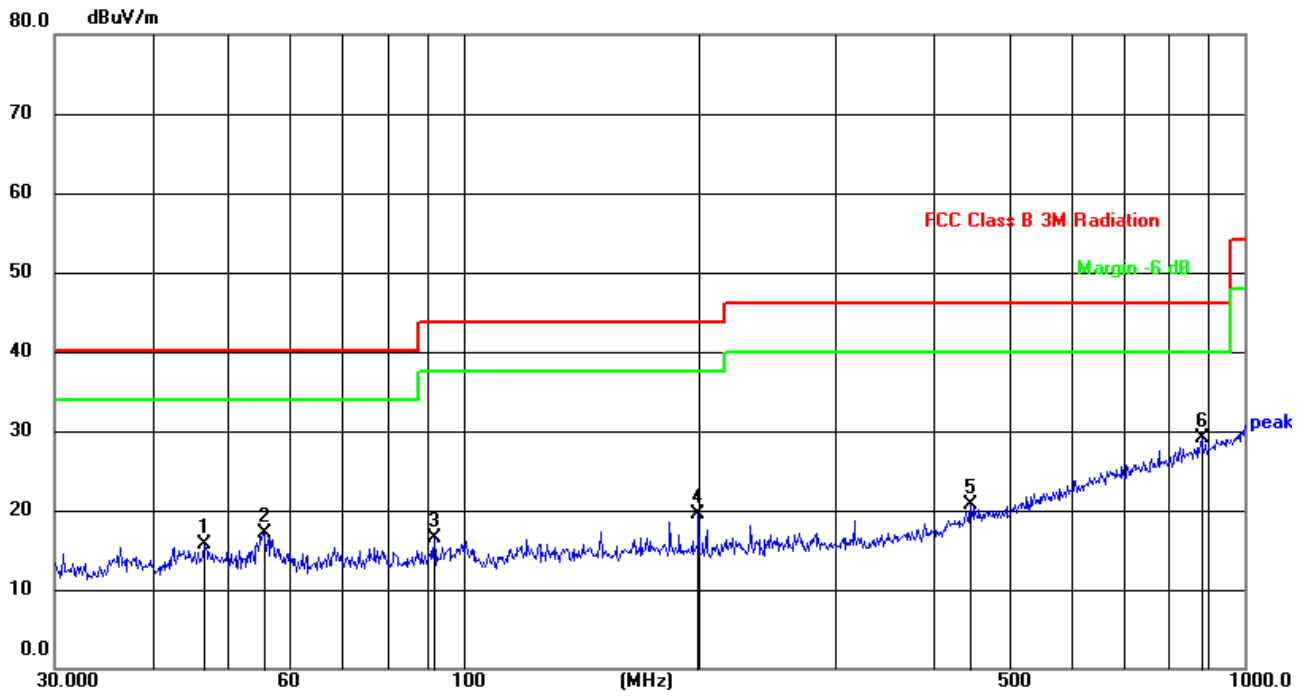

No.	Frequency (MHz)	Reading (dBuV)	Factor (dB/m)	Level (dBuV/m)	Limit (dBuV/m)	Margin (dB)	Detector
1	46.6663	36.71	-20.98	15.73	40.00	-24.27	QP
2	55.6093	37.96	-20.84	17.12	40.00	-22.88	QP
3	91.8162	36.62	-20.04	16.58	43.50	-26.92	QP
4	199.9855	38.35	-18.91	19.44	43.50	-24.06	QP
5	446.4140	35.59	-14.88	20.71	46.00	-25.29	QP
6	881.4067	35.22	-6.20	29.02	46.00	-16.98	QP

Level = Reading + Factor, Margin=level-Limit

Factor= Antenna Factor + Cable Loss – Preamplifier Factor

■ Above 1GHz

Test channel:	Lowest
---------------	--------

Peak value:

Frequency (MHz)	Read Level (dBuV)	Antenna Factor (dB/m)	Cable Loss (dB)	Preamp Factor (dB)	Level (dBuV/m)	Limit Line (dBuV/m)	Over Limit (dB)	Polarization
4804.00	64.90	32.10	5.96	45.70	57.26	74.00	-16.74	Vertical
7206.00	61.22	36.10	6.86	45.50	58.68	74.00	-15.32	Vertical
9608.00	57.18	38.30	8.25	46.20	57.53	74.00	-16.47	Vertical
12010.00	*	--	--	--	--	74.00	--	Vertical
14412.00	*	--	--	--	--	74.00	--	Vertical
4804.00	66.73	32.10	5.96	45.70	59.09	74.00	-14.91	Horizontal
7206.00	60.87	36.10	6.86	45.50	58.33	74.00	-15.67	Horizontal
9608.00	59.22	38.30	8.25	46.20	59.57	74.00	-14.43	Horizontal
12010.00	*					74.00		Horizontal
14412.00	*					74.00		Horizontal

Average value:

Frequency (MHz)	Read Level (dBuV)	Antenna Factor (dB/m)	Cable Loss (dB)	Preamp Factor (dB)	Level (dBuV/m)	Limit Line (dBuV/m)	Over Limit (dB)	Polarization
4804.00	50.06	32.10	5.96	45.70	42.42	54.00	-11.58	Vertical
7206.00	44.05	36.10	6.86	45.50	41.51	54.00	-12.49	Vertical
9608.00	42.84	38.30	8.25	46.20	43.19	54.00	-10.81	Vertical
12010.00	*	--	--	--	--	54.00	--	Vertical
14412.00	*	--	--	--	--	54.00	--	Vertical
4804.00	50.64	32.10	5.96	45.70	43.00	54.00	-11.00	Horizontal
7206.00	44.73	36.10	6.86	45.50	42.19	54.00	-11.81	Horizontal
9608.00	42.66	38.30	8.25	46.20	43.01	54.00	-10.99	Horizontal
12010.00	*					54.00		Horizontal
14412.00	*					54.00		Horizontal

Test channel:	Middle
---------------	--------

Peak value:

Frequency (MHz)	Read Level (dBuV)	Antenna Factor (dB/m)	Cable Loss (dB)	Preamp Factor (dB)	Level (dBuV/m)	Limit Line (dBuV/m)	Over Limit (dB)	Polarization
4882.00	64.81	32.10	5.96	45.70	57.17	74.00	-16.83	Vertical
7323.00	59.95	36.80	6.86	45.50	58.11	74.00	-15.89	Vertical
9764.00	58.03	38.40	8.25	46.20	58.48	74.00	-15.52	Vertical
12205.00	*	--	--	--	--	74.00	--	Vertical
14646.00	*	--	--	--	--	74.00	--	Vertical
4882.00	67.20	32.10	5.96	45.70	59.56	74.00	-14.44	Horizontal
7323.00	61.82	36.80	6.86	45.50	59.98	74.00	-14.02	Horizontal
9764.00	56.88	38.40	8.25	46.20	57.33	74.00	-16.67	Horizontal
12205.00	*					74.00		Horizontal
14646.00	*					74.00		Horizontal

Average value:

Frequency (MHz)	Read Level (dBuV)	Antenna Factor (dB/m)	Cable Loss (dB)	Preamp Factor (dB)	Level (dBuV/m)	Limit Line (dBuV/m)	Over Limit (dB)	Polarization
4882.00	49.92	32.10	5.96	45.70	42.28	54.00	-11.72	Vertical
7323.00	42.94	36.80	6.86	45.50	41.10	54.00	-12.90	Vertical
9764.00	41.22	38.40	8.25	46.20	41.67	54.00	-12.33	Vertical
12205.00	*	--	--	--	--	54.00	--	Vertical
14646.00	*	--	--	--	--	54.00	--	Vertical
4882.00	48.74	32.10	5.96	45.70	41.10	54.00	-12.90	Horizontal
7323.00	43.81	36.80	6.86	45.50	41.97	54.00	-12.03	Horizontal
9764.00	40.90	38.40	8.25	46.20	41.35	54.00	-12.65	Horizontal
12205.00	*					54.00		Horizontal
14646.00	*					54.00		Horizontal

Test channel:	Highest
---------------	---------

Peak value:

Frequency (MHz)	Read Level (dBuV)	Antenna Factor (dB/m)	Cable Loss (dB)	Preamplifier Factor (dB)	Level (dBuV/m)	Limit Line (dBuV/m)	Over Limit (dB)	Polarization
4960.00	64.30	32.70	5.96	45.70	57.26	74.00	-16.74	Vertical
7440.00	59.96	36.40	6.86	45.50	57.72	74.00	-16.28	Vertical
9920.00	58.34	38.00	8.25	46.20	58.39	74.00	-15.61	Vertical
12400.00	*	--	--	--	--	74.00	--	Vertical
14880.00	*	--	--	--	--	74.00	--	Vertical
4960.00	64.72	32.70	5.96	45.70	57.68	74.00	-16.32	Horizontal
7440.00	60.23	36.40	6.86	45.50	57.99	74.00	-16.01	Horizontal
9920.00	59.18	38.00	8.25	46.20	59.23	74.00	-14.77	Horizontal
12400.00	*					74.00		Horizontal
14880.00	*					74.00		Horizontal

Average value:

Frequency (MHz)	Read Level (dBuV)	Antenna Factor (dB/m)	Cable Loss (dB)	Preamplifier Factor (dB)	Level (dBuV/m)	Limit Line (dBuV/m)	Over Limit (dB)	Polarization
4960.00	44.98	32.70	5.96	45.70	37.94	54.00	-16.06	Vertical
7440.00	41.36	36.40	6.86	45.50	39.12	54.00	-14.88	Vertical
9920.00	41.92	38.00	8.25	46.20	41.97	54.00	-12.03	Vertical
12400.00	*	--	--	--	--	54.00	--	Vertical
14880.00	*	--	--	--	--	54.00	--	Vertical
4960.00	46.18	32.70	5.96	45.70	39.14	54.00	-14.86	Horizontal
7440.00	41.79	36.40	6.86	45.50	39.55	54.00	-14.45	Horizontal
9920.00	40.78	38.00	8.25	46.20	40.83	54.00	-13.17	Horizontal
12400.00	*					54.00		Horizontal
14880.00	*					54.00		Horizontal

Remarks:

1. Final Level = Receiver Read level + Antenna Factor + Cable Loss – Preamplifier Factor
2. “*”, means this data is too weak instrument of signal is unable to test.
3. The emission levels of other frequencies are very lower than the limit and not show in test report.
4. The test data shows only the worst case 8-DPSK mode

5 Test Setup Photo

Reference to the **appendix I** for details.

6 EUT Constructional Details

Reference to the **appendix II** for details.

-----End-----