



Solutions

TEST REPORT

Test Report No.: UL-RPT-RP-14768916-916-FCC

Applicant * : iSens Electrónica, Lda.
Model No. * : iLogger Case 2
FCC ID * : 2A350-ILOGGERCASE2
Technology : RFID 13.56 MHz
Test Standard(s) : **FCC Parts 15.209(a) & 15.225**
For details of applied tests refer to test result summary

1. This test report shall not be reproduced in full or partial, without the written approval of UL International Germany GmbH.
2. The results in this report apply only to the sample tested.
3. The test results in this report are traceable to the national or international standards.
4. Test Report Version 1.0
5. Result of the tested sample: **PASS**
6. All information marked with a (*) were provided by customer / applicant or authorized representative

Prepared by: Muhammad Faiq Khan
Title: Project Engineer
Date: 25 May 2023

Prepared by: Rachid Acharkaoui
Title: Operations Manager
Date: 25 May 2023



Deutsche
Akkreditierungsstelle
D-PL-19381-02-00

This laboratory is accredited by DAkkS.
The tests reported herein have been performed in
accordance with its' terms of accreditation.

This page has been left intentionally blank.

Table of Contents

1. Customer Information *	4
1.1. Applicant Information	4
1.2. Manufacturer Information	4
2. Summary of Testing	5
2.1. General Information	5
Applied Standards	5
Location	5
Date information	5
2.2. Summary of Test Results	6
Note(s):	6
2.3. Methods and Procedures	6
2.4. Deviations from the Test Specification	6
3. Equipment Under Test (EUT)	7
3.1. Identification of Equipment Under Test (EUT) *	7
3.2. Description of EUT *	7
3.3. Modifications Incorporated in the EUT	7
3.4. Additional Information Related to Testing *	8
3.5. Support Equipment	8
A. Support Equipment (In-house)	8
B. . Support Equipment (Manufacturer supplied) *	8
4. Operation and Monitoring of the EUT during Testing	9
4.1. Operating Modes	9
4.2. Configuration and Peripherals	9
5. Measurements, Examinations and Derived Results	10
5.1. General Comments	10
5.2. Test Results	11
5.2.1. Transmitter 20 dB Bandwidth	11
5.2.2. Transmitter Fundamental Field Strength & Spectrum Mask	13
5.2.3. Transmitter Radiated Spurious Emissions	17
5.2.4. Transmitter Frequency Stability (Temperature & Voltage Variation)	22
6. Measurement Uncertainty	26
7. Used equipment	27
8. Open-Area-Test Site comparison	28
9. Report Revision History	32

1. Customer Information *

1.1.Applicant Information

Company Name:	iSens Electrónica, Lda.
Company Address:	Rua de Orlando Ribeiro n 78 4465-591 Leça do Balio, Portugal
Company Phone No.:	+351 220 198 410
Company E-Mail:	info@maksense.com
Contact Person:	André Toga
Contact E-Mail Address:	Andre.toga@maksense.com
Contact Phone No.:	+351 935 908 105

1.2.Manufacturer Information

Company Name:	iSens Electrónica, Lda.
Company Address:	Rua de Orlando Ribeiro n 78 4465-591 Leça do Balio, Portugal
Company Phone No.:	+351 220 198 410
Company E-Mail:	info@maksense.com
Contact Person:	André Toga
Contact E-Mail Address:	Andre.toga@maksense.com
Contact Phone No.:	+351 935 908 105

2. Summary of Testing

2.1. General Information

Applied Standards

Specification Reference:	47CFR15.225
Specification Title:	Code of Federal Regulations Volume 47 (Telecommunications): Part 15 Subpart C (Radio Frequency Devices) - Section 15.225
Specification Reference:	47CFR15.209
Specification Title:	Code of Federal Regulations Volume 47 (Telecommunications): Part 15 Subpart C (Intentional Radiators) - Section 15.209

Location

Location of Testing:	UL International Germany GmbH Hedelfinger Str. 61 70327 Stuttgart Germany
Test Firm Registration:	399704

Date information

Order Date:	17 April 2023
EUT arrived:	02 May 2023
Test Dates:	08 May 2023 to 19 May 2023
EUT returned:	-/-

2.2. Summary of Test Results

Clause	Measurement	Complied	Did not comply	Not performed	Not applicable
Part 15.207	Transmitter AC Conducted Emissions ⁽¹⁾	<input type="checkbox"/>	<input type="checkbox"/>	<input type="checkbox"/>	<input checked="" type="checkbox"/>
Part 15.215(c)	Transmitter 20 dB Bandwidth	<input checked="" type="checkbox"/>	<input type="checkbox"/>	<input type="checkbox"/>	<input type="checkbox"/>
Part 15.225(a)(b)(c)(d)	Transmitter Fundamental Field Strength & Spectrum Mask (continued)	<input checked="" type="checkbox"/>	<input type="checkbox"/>	<input type="checkbox"/>	<input type="checkbox"/>
Part 15.209(a)/ 15.225(d)	Transmitter Radiated Emissions	<input checked="" type="checkbox"/>	<input type="checkbox"/>	<input type="checkbox"/>	<input type="checkbox"/>
Part 15.225(e)	Transmitter Frequency Stability (Temperature & Voltage Variation)	<input checked="" type="checkbox"/>	<input type="checkbox"/>	<input type="checkbox"/>	<input type="checkbox"/>
<p>Decision rule: If the decision rule is not included in the applied customer specification or testing standard, the binary statement for simple acceptance, as defined in ILAC G8: 2019 Section 4.2.1, is applied as the decision rule for a pass/ fail statement. If the measured value is on the limit, the result is defined as a pass. In this case the risk of a false positive is 50%. For further information regarding risk assessment refer to ILAC G8: 2019.</p>					

Note(s):

1. The EUT is operating with non-rechargeable alkaline battery.

2.3. Methods and Procedures

Reference:	ANSI C63.4-2014
Title:	American National Standard for Methods of Measurement of Radio-Noise Emissions from Low-Voltage Electrical and Electronic Equipment in the Range of 9 kHz to 40 GHz.
Reference:	ANSI C63.10-2013
Title:	American National Standard of Procedures for Compliance Testing of Unlicensed Wireless Devices
Reference:	KDB 414788 D01 Radiated Test Site v01r01
Title:	TEST SITES FOR RADIATED EMISSION MEASUREMENTS

2.4. Deviations from the Test Specification

For the measurements contained within this test report, there were no deviations from, additions to, or exclusions from the test specification identified above.

3. Equipment Under Test (EUT)

3.1. Identification of Equipment Under Test (EUT) *

Brand Name:	maksense
Model Name or Number:	iLogger Case 2
Serial Number:	EUT 3 (Radiated test sample)
Hardware Version Number:	1.0.0
Firmware Version Number:	1.0.0
FCC ID:	2A350-ILOGGERCASE2

3.2. Description of EUT *

The equipment under test was a sample transport container with RFID 13.56MHz technology

3.3. Modifications Incorporated in the EUT

No modifications were applied to the EUT during testing.

3.4. Additional Information Related to Testing *

Tested Technology:	RFID 13.56 MHz	
Category of Equipment:	Transceiver	
Channel Spacing:	Single channel device	
Transmit Frequency Range:	13.56 MHz	
Power supply Requirement(s):	6 V DC 4x Type C-LR14 1.5V DC Type: Non rechargeable	
Tested Temperature Range:	Minimum	-20 °C
	Maximum	+50 °C

3.5. Support Equipment

The following support equipment was used to exercise the EUT during testing:

A. Support Equipment (In-house)

Item	Description	Brand Name	Model Name or Number	Serial Number
1	-/-	-/-	-/-	-/-

B. . Support Equipment (Manufacturer supplied) *

Item	Description	Brand Name	Model Name or Number	Serial Number
1	-/-	-/-	-/-	-/-

4. Operation and Monitoring of the EUT during Testing

4.1. Operating Modes

The EUT was tested in the following operating mode(s):

- Continuous transmitting modulated carrier at maximum power in RFID-13.56 MHz test mode.

4.2. Configuration and Peripherals

The EUT was tested in the following configuration(s):

- The customer supplied a document containing the setup instructions which name is “Quick Guide Radio – iLogger Case 2” was used for configuration.

EUT Power supply:

- The EUT can powered via 6 V DC with 4 type C-LR14 fully charged alkaline batteries.
- All tests were performed with EUT powered via fully charged alkaline batteries except voltage variations.
- Voltage variations tests done with a laboratory power supply with varying the input voltage.

Test Mode Activations:

- For RFID 13.56 MHz test mode, after power on EUT activates the RFID communication signal continuously.
- Following customer supplied pre-programmed EUTs were used:
 - RADIO – MODE 1” Only RFID ACT” was used to simulate Operating Mode for transmitter test modes.

Radiated Measurements:

- Before starting final radiated spurious emission measurements “worst case verification” with the EUT in Standing-position & Laying-position was performed by Lab.
- The EUT in Standing-position was found to be the worst case therefore this report includes relevant results.
- Radiated measurements below 30 MHz were performed with the EUT positioned on the turn table and rotating 360 degrees while the loop antenna height was set to 100 cm.
- Radiated measurements above 30 MHz were performed with the EUT positioned on the turn table and rotating 360 degrees while the antenna height varies from 1 to 4 m over the measurement frequency range.
- R&S®EMC32 Measurement Software V11.30.00 was used for the radiated spurious emission measurements.

5. Measurements, Examinations and Derived Results

5.1. General Comments

Measurement uncertainties are evaluated in accordance with current best practice. Our reported expanded uncertainties are based on standard uncertainties, which are multiplied by an appropriate coverage factor to provide a statistical confidence level of approximately 95%. Please refer to Section 6 *Measurement Uncertainty* for details.

In accordance with DAkkS requirements all the measurement equipment is on a calibration schedule. All equipment was within the calibration period on the date of testing.

5.2. Test Results

5.2.1. Transmitter 20 dB Bandwidth

Test Summary:

Test Engineer:	Muhammad Faiq Khan	Test Dates:	16 May 2023
Test Sample Serial Number:	EUT 3 (Radiated test sample)		
Test Site Identification	SR 9		

FCC Reference:	Part 15.215(c)
Test Method Used:	ANSI C63.10 Section 6.9.2

Environmental Conditions:

Temperature (°C):	22.1
Relative Humidity (%):	40.5

Settings of the Instrument:

RBW/VBW	30 kHz / 100 kHz
Span	3 MHz
Sweep time	Auto
Detector	MaxPeak

Notes:

1. The measurement was performed by setting the RBW to 500 Hz and the VBW to 2kHz, which differs from the procedure detailed in ANSI C63.10 6.9.2, due to the difficulty of selecting an appropriate RBW (1% to 5% of the OBW) for this technology. The span was 25 kHz and Peak detector was set on Max hold. The ndB down function of the marker was used where n is 20 dB.
2. The deviation (use of a larger RBW and VBW compared to the 20 dB BW) was agreed with the FCC via a generic KDB inquiry. Since it is difficult to perform the measurement of 20 dB bandwidth for the devices transmitting at 13.56 MHz as per test procedure detailed in ANSI C63.10 6.9.2.

Test Setup:

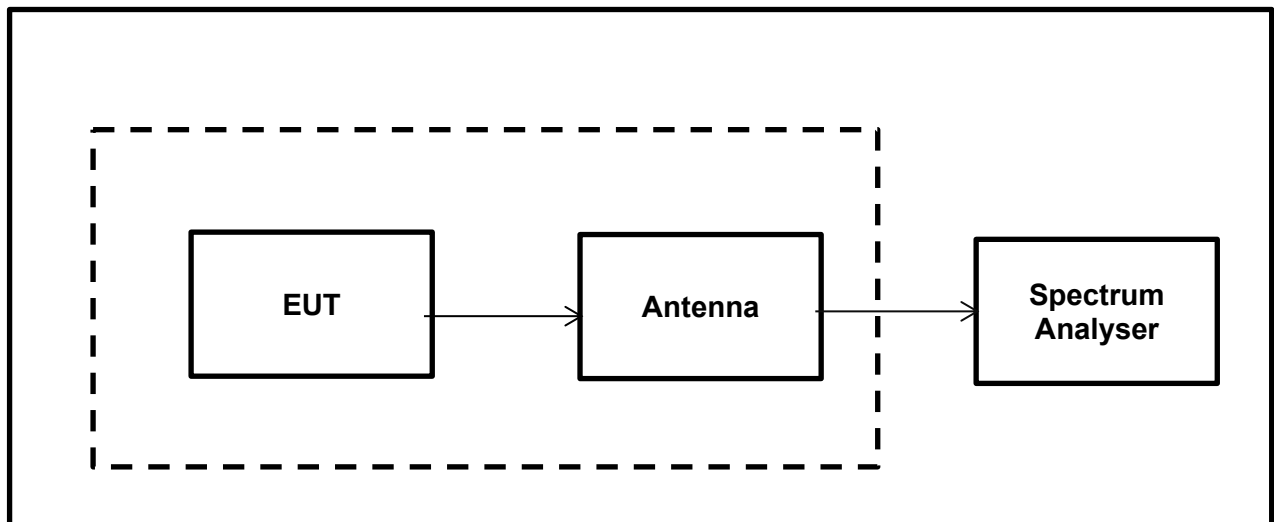

Transmitter 20 dB Bandwidth (continued)

Results: RFID 13.56 MHz

RFID Channel	20 dB Bandwidth (kHz)
13.56 MHz	2.518

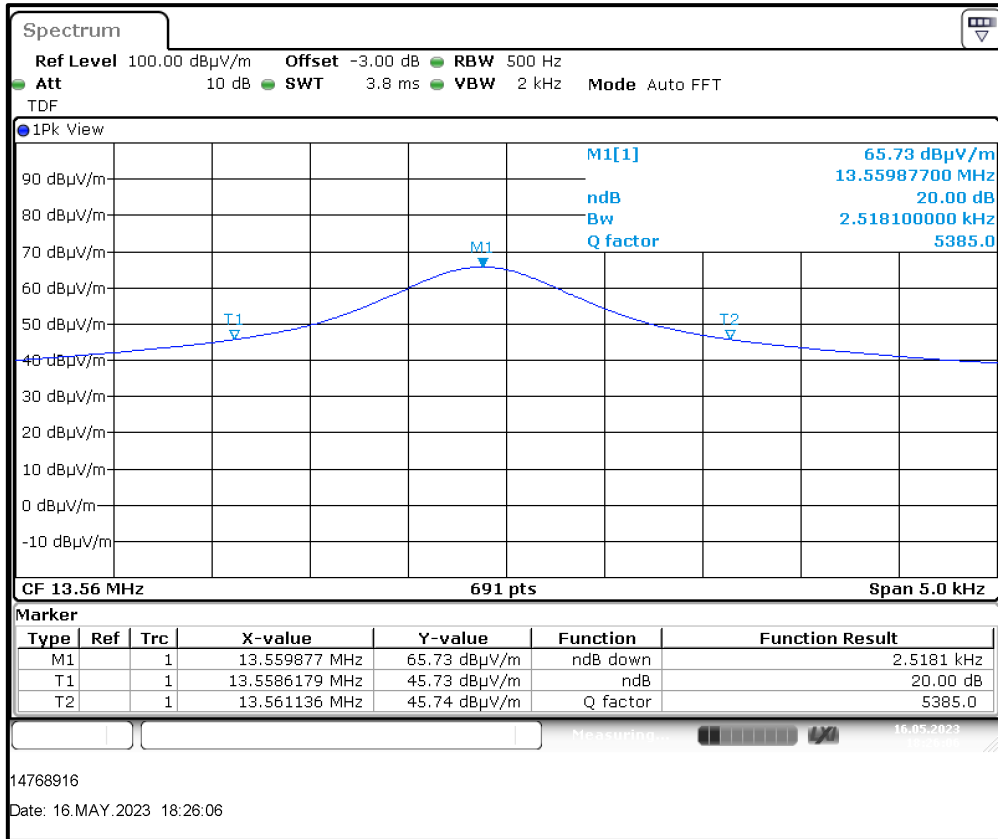

RFID 13.56 MHz

Result: Pass

5.2.2. Transmitter Fundamental Field Strength & Spectrum Mask**Test Summary:**

Test Engineer:	Abbas Al-Hussainy	Test Date:	09 May 2023
Test Sample Serial Number:	EUT 3 (Radiated test sample)		
Test Site Identification	SR 1/2		

FCC Reference:	Part 15.225(a)(b)(c)(d)
Test Method Used:	ANSI C63.10 Section 6.4

Environmental Conditions:

Temperature (°C):	25.3
Relative Humidity (%):	48.2

Note(s):

1. The limit is specified at a test distance of 30 metres. However, as specified by FCC Section 15.31 (f)(2), measurements may be performed at a closer distance and the measured level corrected to the specified measurement distance by using the square of an inverse linear distance extrapolation factor (40 dB/decade).
2. In accordance with FCC KDB 414788 D01 Radiated Test Site v01 an alternative Test Site was used. Instead of an OATS a Semi Anechoic Chamber was used where evidence was shown that the behaviour is the same. A maximum deviation of 1.38 dB for 13.56 MHz could be determined. This deviation is also taken into account to the result.
3. Therefore, applicable limits were extrapolated from 30 m to 3 m using a distance extrapolation factor of 40 dB/decade. The transducer factor on the measuring instrument was used to extrapolate the measured values from 30 m to 3 m using a distance extrapolation factor of 40 dB/decade.
4. Pre-scan measurements were performed using a spectrum analyser with a peak detector and measurement bandwidth of 10 kHz. The fundamental field strength was maximized by rotating the measurement antenna and EUT. The spectrum analyser was then switched to test receiver mode and the final measurement on the maximized level was performed.
5. Compliance with the spectrum mask is shown by final measurements performed in a semi-anechoic chamber. For the field strength measurements in a semi-anechoic chamber, a transducer factor on the measuring instrument was used to extrapolate the results at 3 m to a distance of 30 m. A distance extrapolation factor of 40 dB was used.
6. A transducer factor was used on the spectrum analyser during measurement. This factor includes correction between the fixed gain of the magnetic loop antenna and the calibration values. It also includes the value of the RF cable used to connect the antenna to the spectrum analyser which was incorporated into the annual calibration of the magnetic loop antenna.
7. For the emissions appearing within the 13.110-14.010 MHz band, compliance with the spectrum mask is shown in accordance with FCC Part 15.225(a)(b)(c)(d) limits.
8. The emissions shown at frequencies approximately at 13.56 MHz on the plot represent EUT's fundamental field strength for RFID 13.56 MHz.
9. For the emissions appearing outside of the 13.110-14.010 MHz band, compliance with the spectrum mask is shown in accordance with FCC Part 15.225(d) referencing FCC Part 15.209 general radiated emission limits.

Transmitter Fundamental Field Strength & Spectrum Mask(continued)
Open Area Test Site

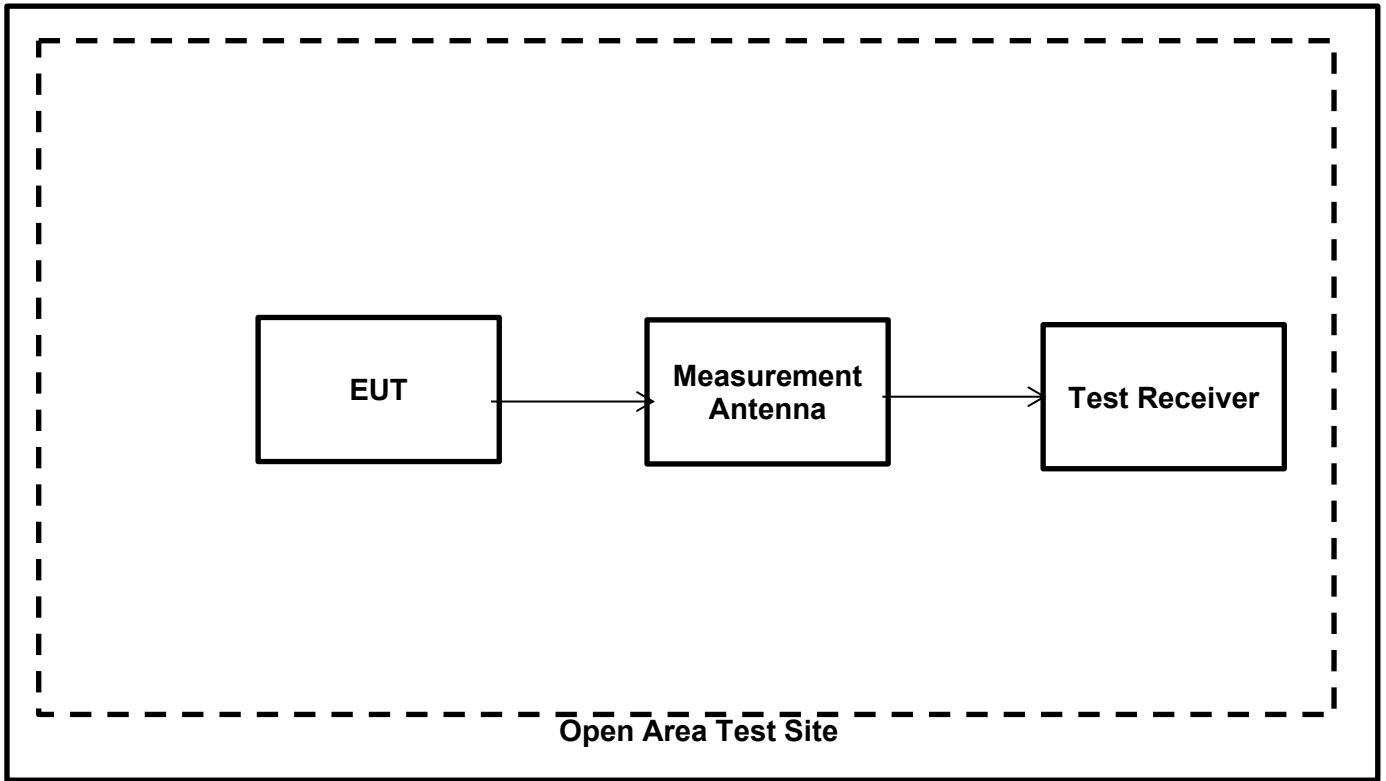

Semi Anechoic Chamber

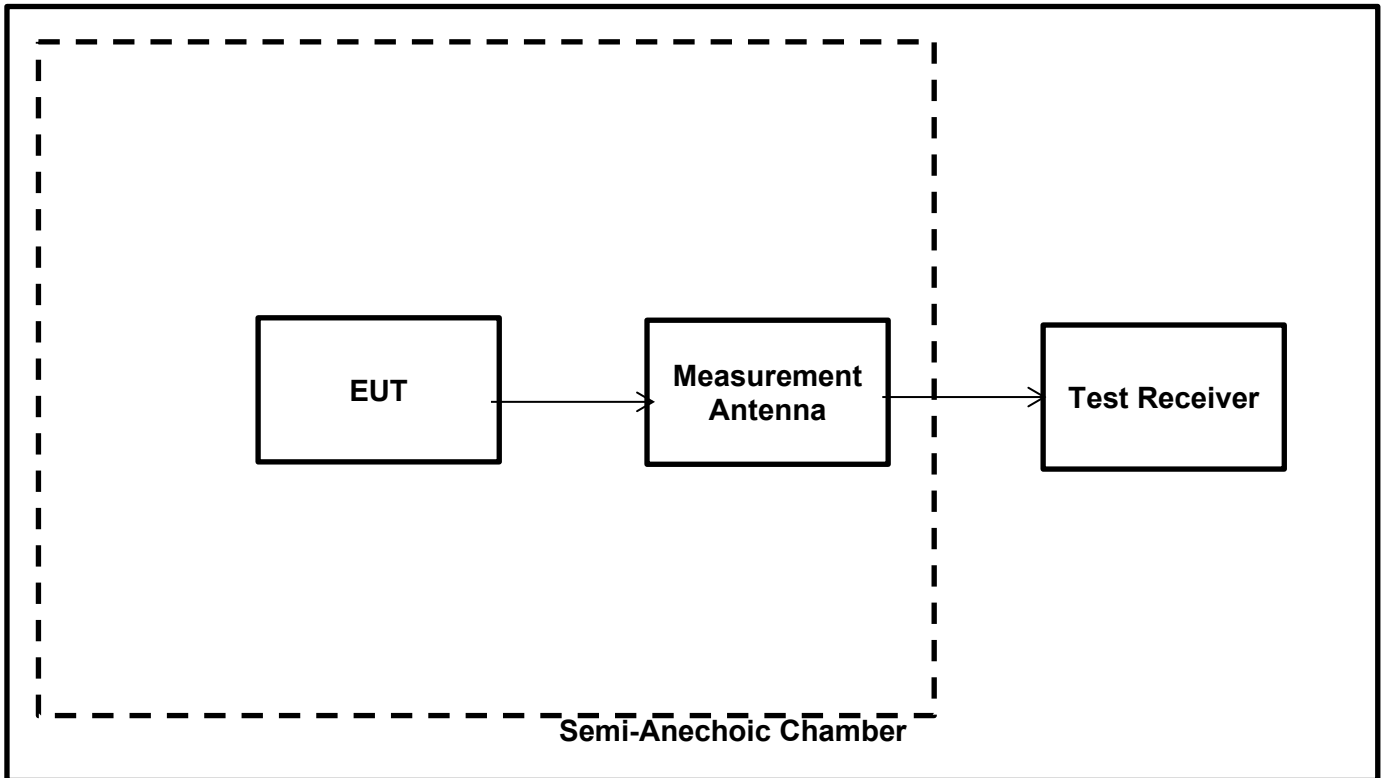

Transmitter Fundamental Field Strength & Spectrum Mask (continued)
Results: Fully Charged Batteries / RFID 13.56 MHz

Frequency Band (MHz)	Emission Frequency (MHz)	Loop Antenna Orientation	MaxPeak Emission Level at 3 m (dB μ V/m) Note 3	Deviation from OATS to SAC (dB)	Deviation Corrected Level at 3 m (dB μ V/m)	Limit at 3 m (dB μ V/m) Note 3	Margin (dB)	Result
12.000 to 13.110	All emissions were found to be below system noise floor							Complied
13.110 to 13.410	13.35	0° to EUT	40.97	1.38	42.35	80.50	38.15	Complied
13.410 to 13.553	13.42	0° to EUT	43.28	1.38	44.66	90.50	45.84	Complied
	13.48	0° to EUT	45.41	1.38	46.79	90.50	43.71	Complied
13.553 to 13.567	13.56	0° to EUT	64.41	1.38	65.79	124.00	58.21	Complied
13.567 to 13.710	13.64	0° to EUT	46.52	1.38	47.90	90.50	42.60	Complied
	13.69	0° to EUT	45.35	1.38	46.73	90.50	43.77	Complied
13.710 to 14.010	13.77	0° to EUT	44.07	1.07	45.14	80.50	35.36	Complied
	13.85	0° to EUT	34.81	1.07	35.88	80.50	44.62	Complied
14.010 to 15.000	All emissions were found to be below system noise floor							Complied

Transmitter Fundamental Field Strength & Spectrum Mask (continued)
Plot: Fully Charged Batteries / RFID 13.56 MHz

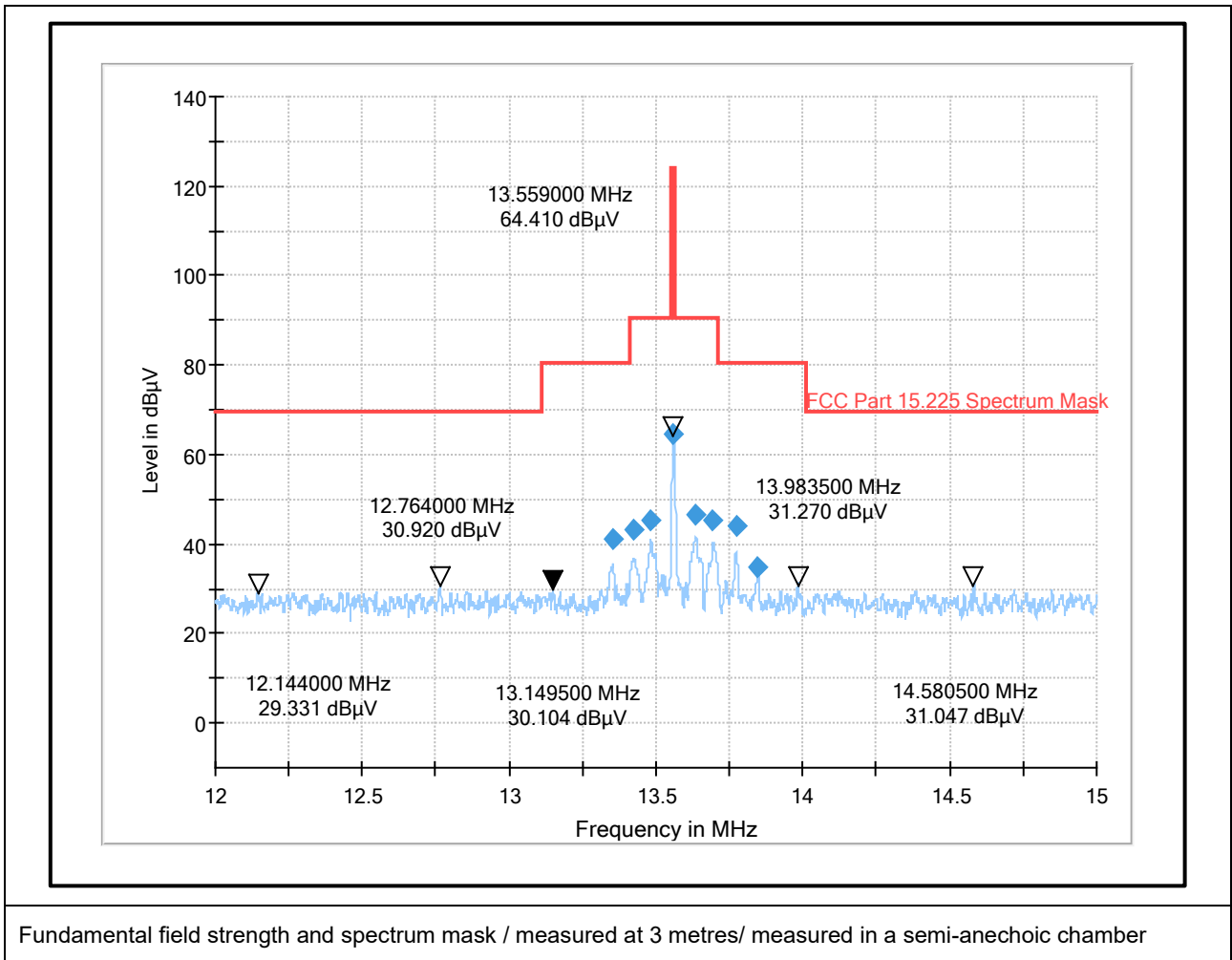

Fundamental field strength and spectrum mask / measured at 3 metres/ measured in a semi-anechoic chamber

Result: Pass

5.2.3. Transmitter Radiated Spurious Emissions**Test Summary:**

Test Engineer:	Abbas Al-Hussainy	Test Date:	05 May 2023
Test Sample Serial Number:	EUT 3 (Radiated test sample)		
Test Site Identification	SR 1/2		

FCC Reference:	Parts 15.225(d) & 15.209(a)
Test Method Used:	ANSI C63.10:2013 Sections 6.3 and 6.4
Frequency Range:	9 kHz to 30 MHz

Environmental Conditions:

Temperature (°C):	25.7
Relative Humidity (%):	42.1

Note(s):

- In accordance with FCC KDB 414788, an alternative test site may be used for the measurement below 30 MHz (The OATS / SAC comparison data is available upon request). Therefore the result from the semi-anechoic chamber tests is shown in this section of the test report.
- The limits are specified at a test distance of 30 m & 300 m. However, as specified by FCC Section 15.31 (f)(2), measurements may be performed at a closer distance and the measured level corrected to the specified measurement distance by using the square of an inverse linear distance extrapolation factor.
- Therefore the limit values are extrapolated to a measurement distance of 3 m where field strength of X dB μ V/m was measured.
 - 9 kHz- 490 kHz: limits extrapolated from 300 m to 3 m adding 80 dB at 40 dB /decade.
 - 490 kHz-1705 kHz: limits extrapolated from 30 m to 3 m by adding 40 dB at 40 dB /decade.
- The final measured value, for the given emission, in the table below incorporates the calibrated antenna factor and cable loss.
- Measurements below 30 MHz were performed in a semi-anechoic chamber SR1/ 2 (Asset Number 1603665) at a distance of 3 m. The EUT was floor standing equipment and placed at on ground plane in the centre of the chamber turntable. The measurement loop antenna height was at 1 m.
- Pre-scans were performed and markers placed on the highest measured levels. The test receiver was set to:
 - Frequency range: 9 kHz-150 kHz : RBW: 300 Hz /VBW: 1 kHz
 - Frequency range: 150 kHz – 30 MHz: RBW: 10 kHz /VBW: 30 kHz
 - Detector: Max-Peak detector
 - Trace Mode: Max Hold
- The emissions shown at frequencies approximately 13.56 MHz on the 9 kHz to 30 MHz plots are the EUT RFID 13.56 MHz fundamental for the tested channel.

Transmitter Radiated Spurious Emission test setup

Test Setup:

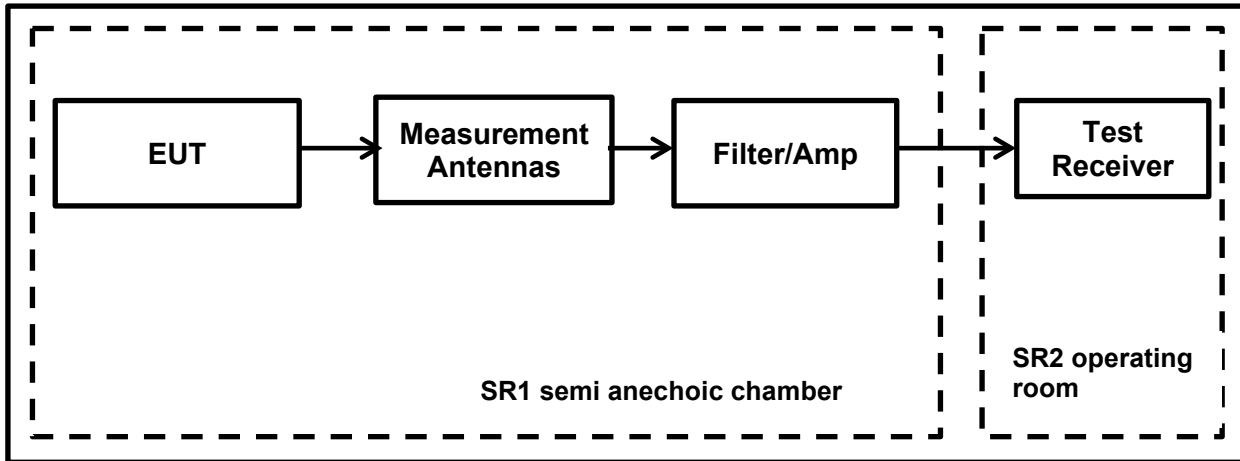

Transmitter Radiated Emissions (continued)

Results: Fully Charged Batteries / RFID 13.56 MHz

Frequency (MHz)	Loop Antenna Orientation	Level (dBµV/m)	Limit (dBµV/m)	Margin (dB)	Result
0.101426	90° to EUT	27.59	106.19	78.60	Complied
0.103964	0° to EUT	32.87	105.98	73.11	Complied
0.144854	0° to EUT	36.08	103.25	67.17	Complied
9.473010	90° to EUT	34.48	70.00	35.52	Complied

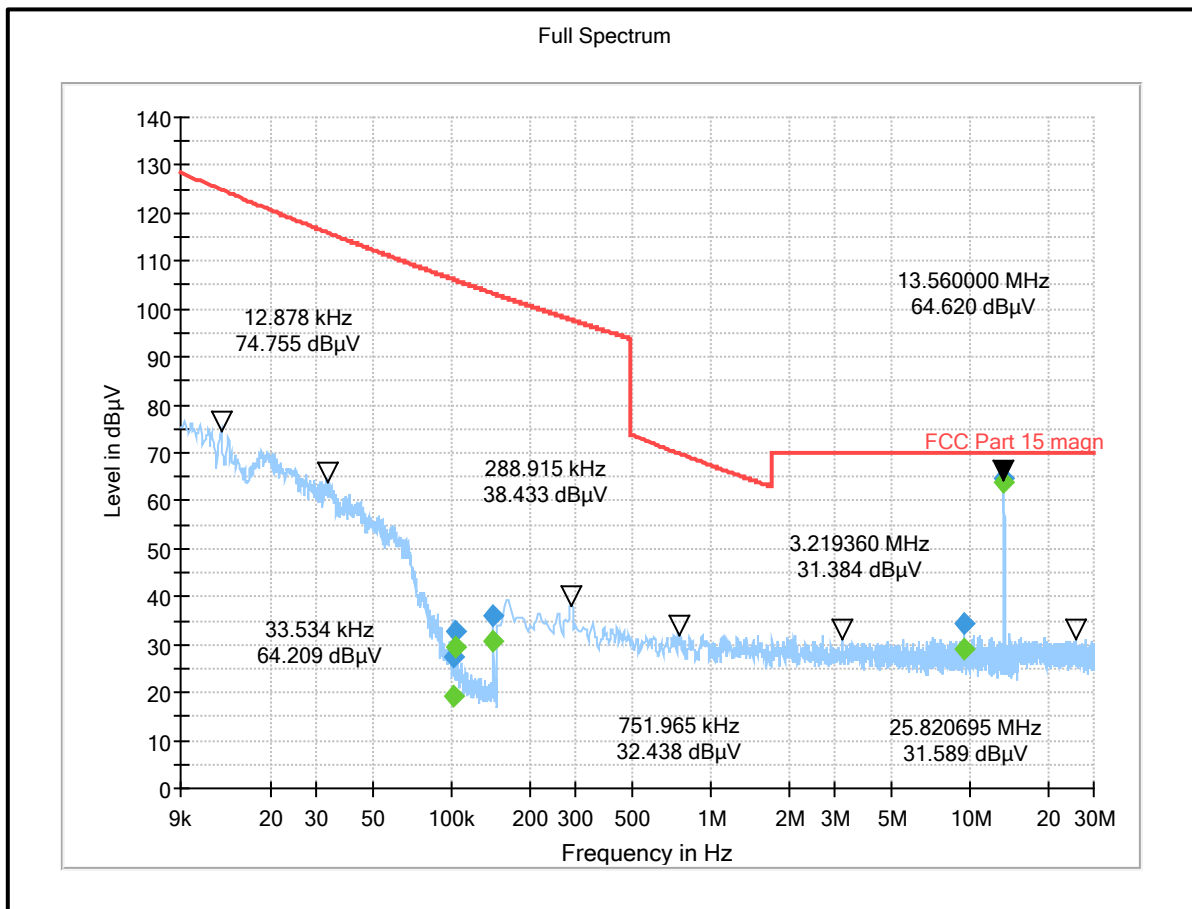

Result: Pass

Transmitter Radiated Emissions (continued)

Test Summary:

Test Engineer:	Abbas Al-Hussainy	Test Date:	09 May 2023
Test Sample Serial Number:	EUT 3		
Test Site Identification	SR 1/2		

FCC Reference:	Parts 15.225(d) & 15.209(a)
Test Method Used:	ANSI C63.10:2013 Sections 6.3 and 6.5
Frequency Range:	30 MHz to 1000 MHz

Environmental Conditions:

Temperature (°C):	25.3
Relative Humidity (%):	48.2

Note(s):

1. All emissions shown on the pre-scan plot were investigated and found to be ambient or >20 dB below the appropriate limit or below the measurement system noise floor.
2. Measurements below 30 MHz were performed in a semi-anechoic chamber SR1/ 2 (Asset Number 1603665) at a distance of 3 m. The EUT was floor standing equipment and placed at on ground plane in the centre of the chamber turntable. Maximum emission levels were determined by height searching the measurement antenna over the range 1 m to 4 m.
3. Pre-scans were performed and markers placed on the highest measured levels. The test receiver resolution bandwidth was set to 100 kHz and video bandwidth 300 kHz. A peak detector was used, sweep time was set to auto and trace mode was Max Hold.

Test Setup:

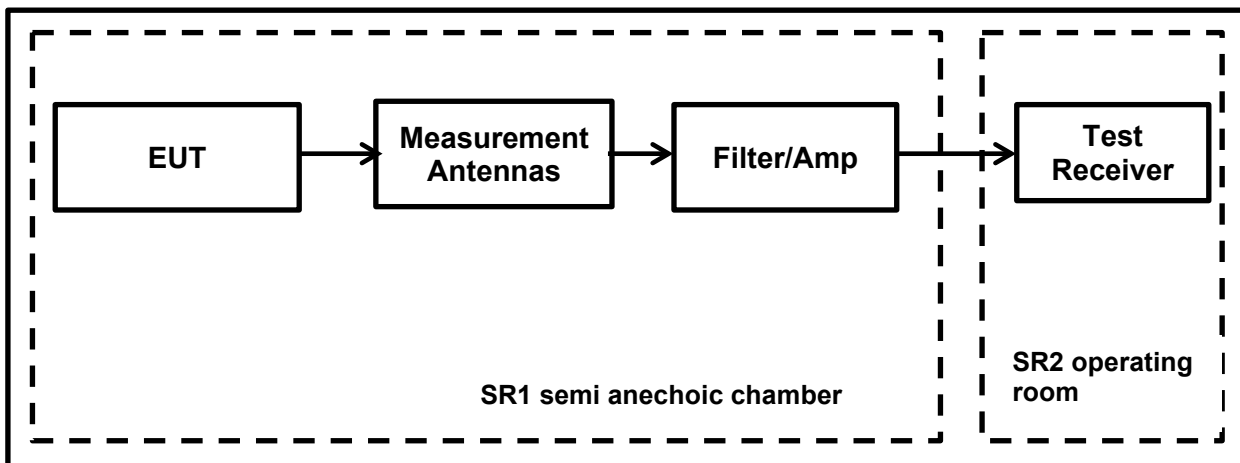

Transmitter Radiated Emissions (continued)

Results: Fully Charged Batteries / RFID 13.56 MHz

Frequency (MHz)	Antenna Polarization	Level (dB μ V/m)	Limit (dB μ V/m)	Margin (dB)	Result
46.020	Horizontal	19.32	40.00	20.68	Complied
216.975	Horizontal	34.61	46.00	11.39	Complied
244.110	Horizontal	37.65	46.00	8.35	Complied
586.708	Vertical	28.03	46.00	17.97	Complied

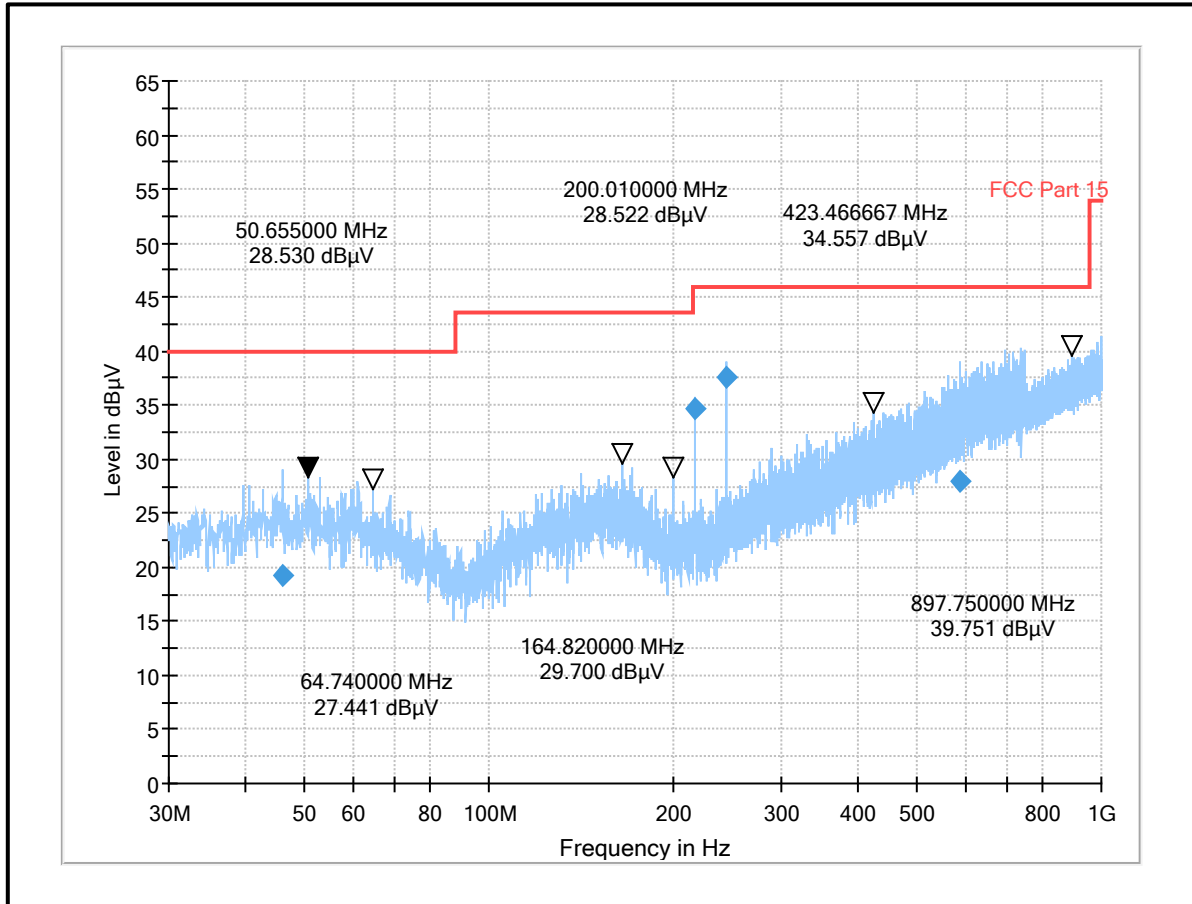

Result: Pass

5.2.4. Transmitter Frequency Stability (Temperature & Voltage Variation)**Test Summary:**

Test Engineer:	Muhammad Faiq Khan	Test Dates:	17 May 2023 & 19 May 2023
Test Sample Serial Number:	EUT 3 (Radiated test sample)		
Test Site Identification	SR 9		

FCC Reference:	Part 15.225(e)
Test Method Used:	ANSI C63.10 Sections 6.8.1 and 6.8.2

Environmental Conditions:

Ambient Temperature (°C):	23.5
Ambient Relative Humidity (%):	43.2

Settings of the Instrument

RBW/VBW	30 Hz/30 kHz
Span	4 kHz
Sweep Time	Auto
Sweep Mode	Single Sweep
Detector	Peak
Marker Function	Signal Count

Note(s):

1. The EUT was kept inside the environmental/climatic test chamber. The tests were performed with extreme temperature & extreme voltage variations.
2. The temperature variations were monitored throughout the tests using a calibrated digital thermometer. The voltage variations were monitored throughout the tests using a calibrated digital multimeter.
3. For accurate measurement of frequency deviations, Signal Count / frequency counter function was activated on the spectrum analyser.
4. The applicant's declared operating frequency 13.560 MHz was used as reference frequency.
5. The difference between operating /reference frequency & measured frequency was reported as a frequency error.
6. The frequency tolerance of the carrier signal shall be maintained within $\pm 0.01\%$ or 100 ppm of the operating frequency

Transmitter Frequency Stability (Temperature & Voltage Variation) (continued)

Test Setup:

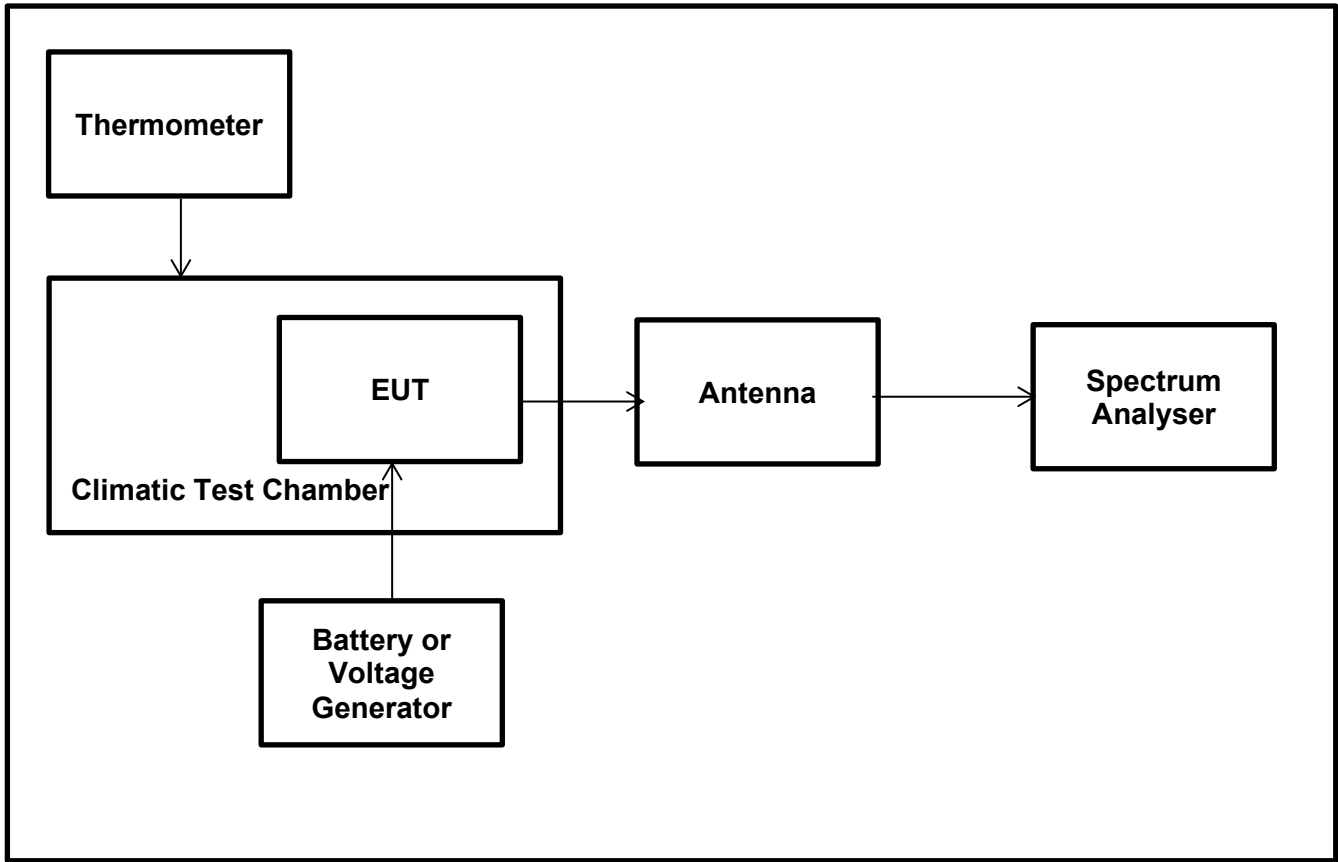

Transmitter Frequency Stability (Temperature & Voltage Variation) (continued)**Results: Fully Charged Batteries / RFID 13.56 MHz / Temperature Variations**

Extreme Temperature (°C)	Time after EUT Power-up	Measured Frequency (MHz)	Frequency Error		Frequency Error Limits		Result
			%	ppm	%	ppm	
-20	at 0 minutes	13.559863017	-0.001010199	-10.10	± 0.01	± 100	Complied
	at 2 minutes	13.559872606	-0.000939484	-9.39	± 0.01	± 100	Complied
	at 5 minutes	13.559865625	-0.000990966	-9.91	± 0.01	± 100	Complied
	at 10 minutes	13.559859461	-0.001036423	-10.36	± 0.01	± 100	Complied
-10	at 0 minutes	13.559900479	-0.000733931	-7.34	± 0.01	± 100	Complied
	at 2 minutes	13.559901663	-0.000725199	-7.25	± 0.01	± 100	Complied
	at 5 minutes	13.559903318	-0.000712994	-7.13	± 0.01	± 100	Complied
	at 10 minutes	13.559893341	-0.000786571	-7.87	± 0.01	± 100	Complied
0	at 0 minutes	13.559902328	-0.000720295	-7.20	± 0.01	± 100	Complied
	at 2 minutes	13.559902225	-0.000721055	-7.21	± 0.01	± 100	Complied
	at 5 minutes	13.559901328	-0.000727670	-7.28	± 0.01	± 100	Complied
	at 10 minutes	13.559900547	-0.000733429	-7.33	± 0.01	± 100	Complied
+10	at 0 minutes	13.559889233	-0.000816866	-8.17	± 0.01	± 100	Complied
	at 2 minutes	13.559888629	-0.000821320	-8.21	± 0.01	± 100	Complied
	at 5 minutes	13.559889188	-0.000817198	-8.17	± 0.01	± 100	Complied
	at 10 minutes	13.559890851	-0.000804934	-8.05	± 0.01	± 100	Complied
+20	at 0 minutes	13.559874555	-0.000925111	-9.25	± 0.01	± 100	Complied
	at 2 minutes	13.559874347	-0.000926645	-9.27	± 0.01	± 100	Complied
	at 5 minutes	13.559873672	-0.000931622	-9.32	± 0.01	± 100	Complied
	at 10 minutes	13.559873646	-0.000931814	-9.32	± 0.01	± 100	Complied
+30	at 0 minutes	13.559872524	-0.000940088	-9.40	± 0.01	± 100	Complied
	at 2 minutes	13.559873389	-0.000933709	-9.34	± 0.01	± 100	Complied
	at 5 minutes	13.559872521	-0.000940111	-9.40	± 0.01	± 100	Complied
	at 10 minutes	13.559871308	-0.000949056	-9.49	± 0.01	± 100	Complied
+40	at 0 minutes	13.559868751	-0.000967913	-9.68	± 0.01	± 100	Complied
	at 2 minutes	13.559863285	-0.001008223	-10.08	± 0.01	± 100	Complied
	at 5 minutes	13.559862366	-0.001015000	-10.15	± 0.01	± 100	Complied
	at 10 minutes	13.559861360	-0.001022419	-10.22	± 0.01	± 100	Complied
+50	at 0 minutes	13.559857538	-0.001050605	-10.51	± 0.01	± 100	Complied
	at 2 minutes	13.559856528	-0.001058053	-10.58	± 0.01	± 100	Complied
	at 5 minutes	13.559857388	-0.001051711	-10.52	± 0.01	± 100	Complied
	at 10 minutes	13.559856923	-0.001055140	-10.55	± 0.01	± 100	Complied

Result: Pass

Transmitter Frequency Stability (Temperature & Voltage Variation) (continued)

Results: Fully Charged Batteries / RFID 13.56 MHz / Voltage Variations

Extreme Voltage Conditions	Extreme DC Voltage (V)	Measured Frequency (MHz)	Frequency Error		Frequency Error Limits		Result
			%	ppm	%	ppm	
85% of Rated Primary Supply Voltage	5.1	13.559880948	-0.000878	-8.78	± 0.01	± 100	Complied
Rated Primary Supply Voltage	6.0	13.559877418	-0.000904	-9.04	± 0.01	± 100	Complied
115% of Rated Primary Supply Voltage	6.9	13.559881385	-0.000875	-8.75	± 0.01	± 100	Complied

Result: Pass

6. Measurement Uncertainty

The expression of uncertainty of a measurement result allows realistic comparison of results with reference values and limits given in specifications and standards.

The uncertainty of the result may need to be taken into account when interpreting the measurement results.

The reported expanded uncertainties below are based on a standard uncertainty multiplied by an appropriate coverage factor such that a confidence level of approximately 95% is maintained. For the purposes of this document “approximately” is interpreted as meaning “effectively” or “for most practical purposes”.

Measurement Type	Confidence Level (%)	Calculated Uncertainty
20 dB Bandwidth	95%	±0.87 %
Fundamental Field Strength	95%	±3.10 dB
Radiated Spurious Emissions	95%	±3.10 dB
Frequency Stability	95%	±92 Hz

The methods used to calculate the above uncertainties are in line with those recommended within the various measurement specifications. Where measurement specifications do not include guidelines for the evaluation of measurement uncertainty the published guidance of the appropriate accreditation body is followed.

7. Used equipment

Test site: SR 1/2

ID	Manufacturer	Type	Model	Serial	Calibration Date	Cal. Cycle (months)
1	Rohde & Schwarz	Antenna, Loop	HFH2-Z2	831247/012	10/07/2020	36
377	BONN Elektronik	Amplifier, Low Noise Pre	BLMA 0118-1A	025294B	13/07/2022	12
423	Bonn Elektronik	Amplifier, Low Noise Pre	BLMA 1840-1A	55929	13/07/2022	12
460	Deisel	Turntable	DT 4250 S	n/a	n/a	n/a
452	Schwarzbeck	Antenna, Trilog Broadband	VULB 9168	9168-240	02/09/2020	36
495	Rohde & Schwarz	Antenna, log. - periodical	HL050	100296	06/08/2021	24
496	Rohde & Schwarz	Antenna, log. - periodical	HL050	100297	22/08/2022	24
588	Maturo	Controller	NCD	029/7180311	n/a	n/a
591	Rohde & Schwarz	Receiver	ESU 40	100244/040	13/07/2022	12
669	Rohde & Schwarz	EMI Test Receiver	ESW 44	103087	03/02/2022	18
607	Schwarzbeck	Antenna broadband horn antenna	BBHA 9170	9170-561	15/10/2019	48
608	Rohde & Schwarz	Switch Matrix	OSP 120	101227	lab verification	n/a
628	Maturo	Antenna mast	CAM 4.0-P	224/19590716	n/a	n/a
629	Maturo	Kippeinrichtung	KE 2.5-R-M	MAT002	n/a	n/a
-/-	Testo	Thermo-Hygrometer	608-H1	01	lab verification	n/a
328	SPS	AC/DC power distribution system	PAS 5000	A2464 00/2 0200	lab verification	n/a
1603665	Siemens Matsushita Components	semi-anechoic chamber SR1/ 2	-/-	B83117-A1421-T161	n/a	n/a
681	Maturo	Antenna mast, tilting	BAM4.5-P	402/0718.1	n/a	n/a

Test site: SR 9

ID	Manufacturer	Type	Model	Serial	Calibration Date	Cal. Cycle (months)
625	Schwarzbeck	Antenna, H-field	HFSL 7101	109	lab verification only relative measurements	n/a
637	Rohde & Schwarz	Spectrum Analyser	FSV40	101587	15/07/2022	12
-/-	Testo	Thermo-Hygrometer	608-H1	07	lab verification	n/a
645	Weiss Umwelttechnik	Climatic Chamber	LabEvent T/110/70/3	5822619794 0010	lab verification	n/a

8. Open-Area-Test Site comparison

GPS coordinates

Latitude: 48.765746, Longitude: 9.250684



Open-Area-Test Site comparison (continued)

The following listed equipment was used for the measurement:

Manufacturer	Type	Model	Frequency Range
Rohde & Schwarz	Signal generator	SML03	9 kHz – 30 MHz
Rohde & Schwarz	Receiver, EMI Test	ESIB7	20 Hz – 7 GHz
Rohde & Schwarz	Antenna, Loop	HFH2-Z2	1 kHz – 30 MHz
ETS LINDGREN	Antenna, Loop	6512	1 kHz – 30 MHz
HUBER+SUHNER	RF Cable	-/-	-/-
Elspec	BNC Cable	-/-	-/-

The transmit signal to the ETS Lindgren loop antenna is supplied by the SML signal generator.

The distance of the transmit and receive antenna was 3 m. No other distances can be achieved in SR1 so 10 m and 30 m distances are not possible. Due to this no comparison is possible.

The Results are valid for equipment which is not larger as the loop antenna which represents in the comparison the EUT.

If an EUT is bigger measurements on an OATS are needed.

The measurement was performed on the lowest frequency 9 kHz and was increased by 10 kHz Steps up to 100 kHz. Then the step size was 100 kHz up to 1000 kHz. From 1 MHz up to the last frequency of 30 MHz the step size was 1 MHz. The HFH2-Z2 loop antenna placed at 80 cm height was used as the receive antenna. The intercepted RF signal from this antenna was measured with the ESIB7 Test Receiver and the values were recorded accordingly.

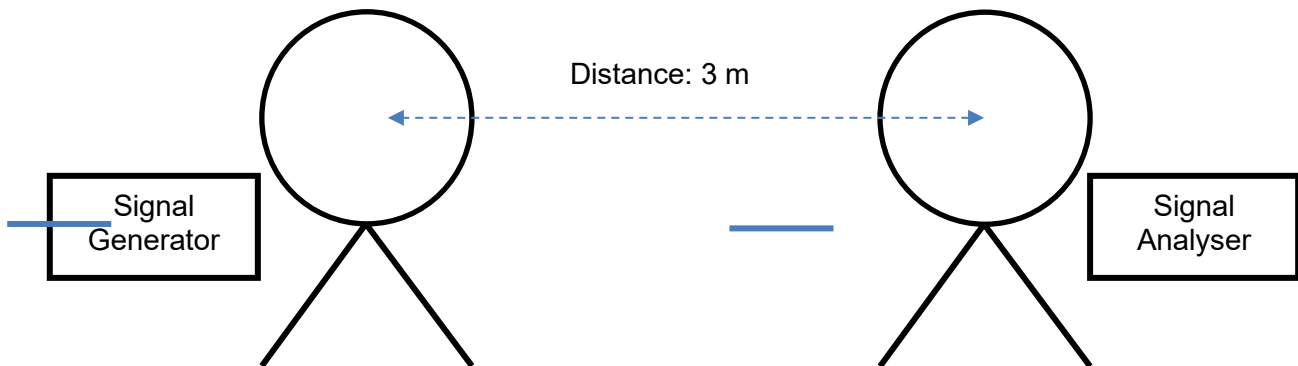

Open-Area-Test Site comparison (continued)

Numeric values:

Frequency (MHz)	0.01	0.02	0.03	0.04	0.05	0.06	0.07	0.08	0.09	0.10	0.125	0.20
SR1 Measured power (dBµV)	87.91	87.22	87.01	86.98	86.40	86.32	85.98	85.20	84.30	83.80	82.96	82.55
OATS Measured power (dBµV)	86.22	87.42	87.50	86.49	86.01	85.39	84.32	84.29	84.20	83.10	83.60	82.32
Delta (dB)	-1.69	0.20	0.49	-0.49	-0.39	-0.93	-1.66	-0.91	-0.10	-0.70	0.64	-0.23

Frequency (MHz)	0.30	0.40	0.50	0.60	0.70	0.80	0.90	1.00	2.00	3.00	4.00	5.00
SR1 Measured power (dBµV)	81.98	81.23	80.39	80.00	79.53	79.10	78.87	78.20	77.60	77.01	76.32	76.04
OATS Measured power (dBµV)	80.84	80.49	79.58	79.58	78.85	78.59	77.69	77.50	77.91	76.90	75.45	74.90
Delta (dB)	-1.14	-0.74	-0.81	-0.42	-0.68	-0.51	-1.18	-0.70	0.31	-0.11	-0.87	-1.14

Frequency (MHz)	6.00	7.00	8.00	9.00	10.00	11.00	12.00	13.00	13.56	14.00	15.00	16.00
SR1 Measured power (dBµV)	75.98	75.43	75.20	74.97	74.59	74.32	74.05	73.83	73.50	73.22	73.20	73.05
OATS Measured power (dBµV)	74.94	74.09	74.11	73.58	73.87	74.38	74.84	74.31	74.88	74.29	73.90	73.93
Delta (dB)	-1.04	-1.34	-1.09	-1.39	-0.72	0.06	0.79	0.48	1.38	1.07	0.70	0.88

Frequency (MHz)	17.00	18.00	19.00	20.00	21.00	22.00	23.00	24.00	25.00	26.00	27.00	28.00	29.00	30.00
SR1 Measured power (dBµV)	73.00	72.86	72.74	72.64	72.50	72.52	72.39	72.20	72.04	71.97	71.86	71.64	71.41	71.27
OATS Measured power (dBµV)	73.70	73.98	72.90	72.60	72.45	72.34	72.59	72.59	71.97	71.59	71.58	71.88	71.98	72.49
Delta (dB)	0.70	1.12	0.16	-0.04	-0.05	-0.18	0.20	0.39	-0.07	-0.38	-0.28	0.24	0.57	1.22

Open-Area-Test Site comparison (continued)

Graph

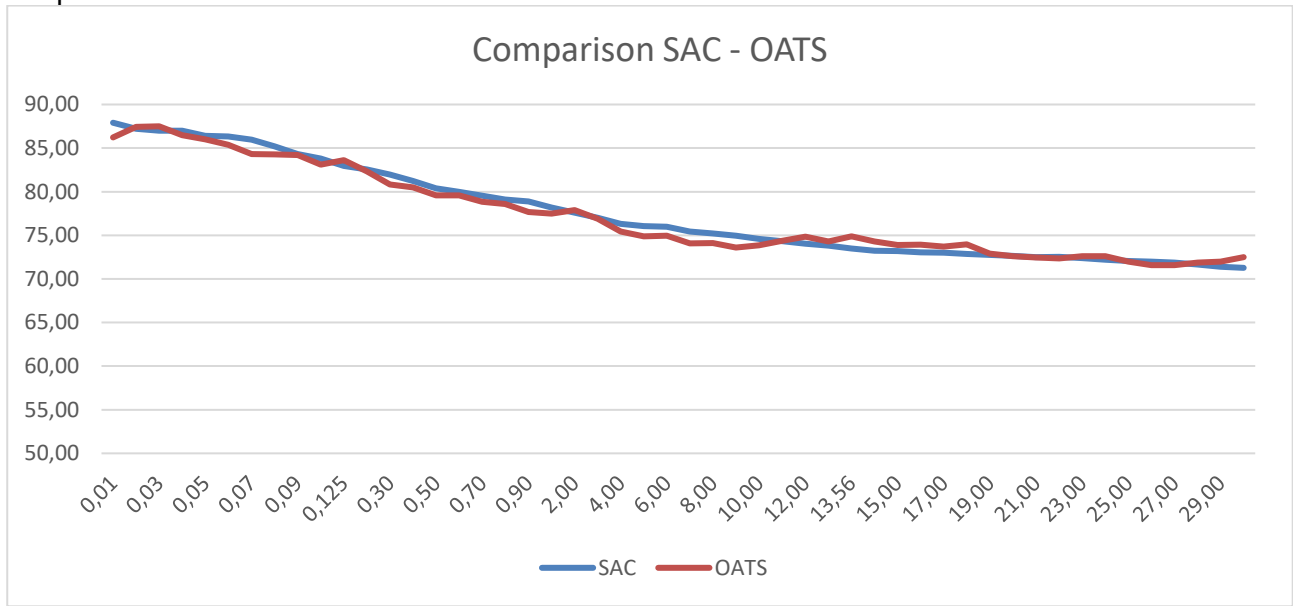

Conclusion: Maximum difference is 1.69 dB @ 9 kHz

9. Report Revision History

Version Number	Revision Details		
	Page No(s)	Clause	Details
1.0	32	-	Initial Version

END of Test Report