



User Manual



Hey,

Welcome to your own toy robot factory, X-KIT!

With this suite, you can create unlimited toy robots by 3D design, model making, 3D printing, and coding. Get ready to dive into the world of robotics.

Let's see how you can tackle it .



02 Overview

03 How It Works

04 Parts List

05 The Hub

08 Charging Guide

09 Electronic Modules

10 Connectors

11 APP Download

12 X-KIT APP

15 Modular Design

18 Graphical Coding

21 Remote Control

23 Projects

24 Explore

25 FAQ

X-KIT is a collaborative suite of an app and hardware.

Please visit the website: <https://en.ime3d.com>



X-KIT Box

Hub / Servo / Sensor / Connector



X-KIT APP

Modular Design / Graphical Coding /
Remote Control

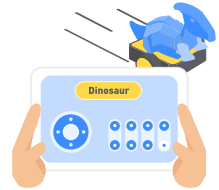
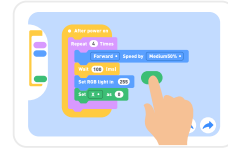
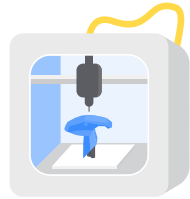
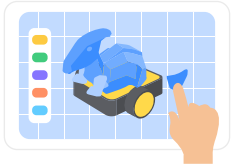

Design

Pick preset design from the list in the app. Customize the design by will. Export the printing file.

3D Print

Send the file to a 3D printer and start to print the components of the design.

Assemble

Put the printed pieces together on the Hub following the instruction shown in the app.

Code

Make and transfer a desirable program for the robot.

Run

Let the robot run or control it by the console in the app.



Note

The order of the process is flexible. For example, users can run the bare Hub without design, or print, or code by direct remote-control.

Parts List



The Hub x1



Servomotor x4



Ultrasound Sensor x1



Buzzer x1



Wheel x2



Tire x8



Rubber Track x2



Ball Pin x1



Axle x1



Long Pin x1



Axle Pin x1



Ball Axle x1



Pin x1



Quick Guide x1



Map x1

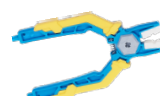

Plier x1



USB x1

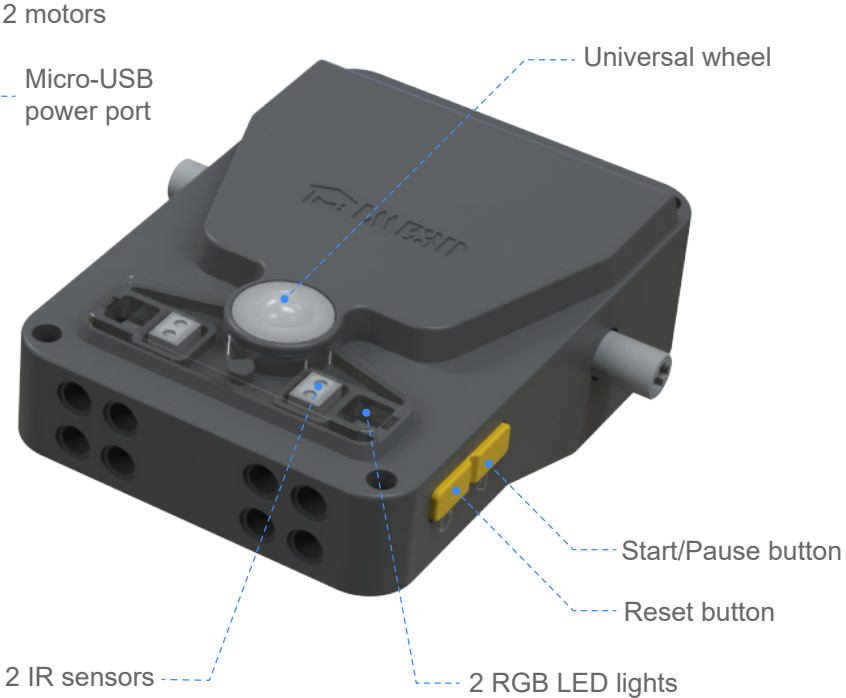

The Hub

Signal Lights



Power Signal

If the green Power signal is on , it means that the Hub is running.

Bluetooth Signal

If the Bluetooth signal is on , it means that the Hub is successfully connected with the app.

Data Signal

If the yellow Data signal is on , it means that data transmission is enabled or programs are ready to run.



Note

The Power signal and the Data signal are both normally turned on.

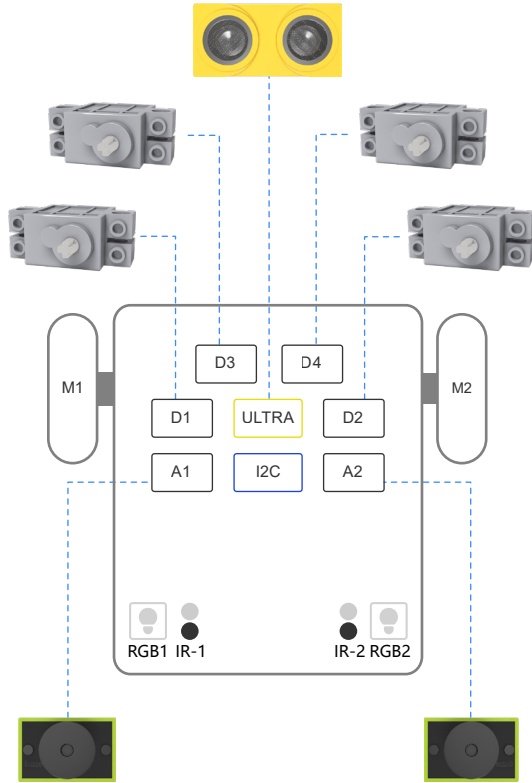

Please refer to the diagram when plugging in electronic modules as servos, sensors. Wrong installation might cause the malfunction of program.

Motor (M1/M2)

They can rotate forward and backward to move.

RGB Lights

Colorful lights can be turned on by manipulating the numbers of RGB values.

IR Sensor

The IR Sensor can recognize black objects in the range of 1-2cm (0.39-0.79in).

When charging

- ★ Make sure the cord is plugged into the power slot.
- ★ Make sure the status of power button is off.
(Power signal is dimmed .)

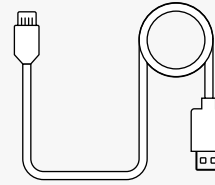
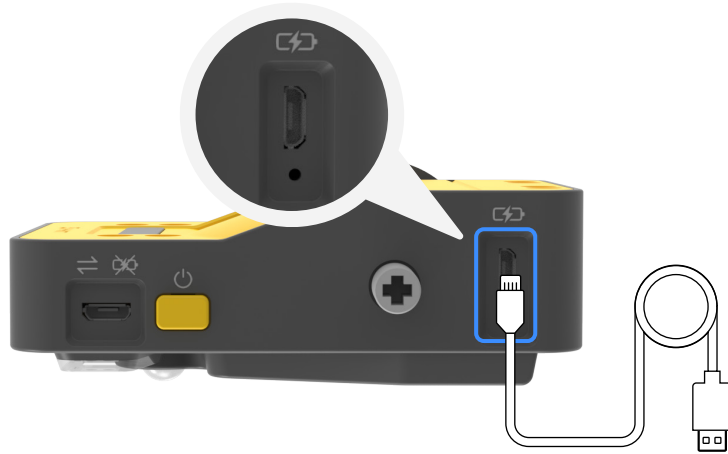

The cord is for both charging and code transfer.

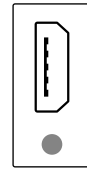

Not charging

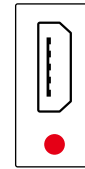

Charging

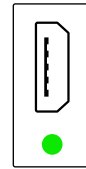

Fully charged



Note

It's needed to remove some parts that block the power slot when a robot is assembled on the hub if you want to charge.

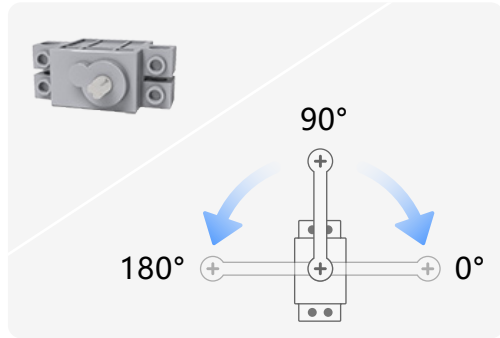

Servomotor

Servomotor is a rotary actuator that allows for precise control. It consists of a suitable motor coupled to a sensor for position feedback. It rotates in an angular range from 0° to 180° , while its default position is at 90° .

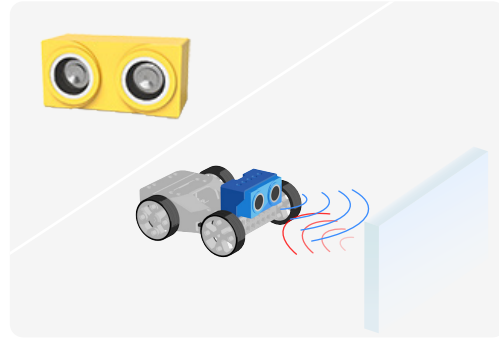

Ultrasonic Sensor

An ultrasonic sensor is an electronic device that measures the distance of a target object by emitting ultrasonic sound waves, and converts the reflected sound into an electrical signal. It can detect objects in its surroundings.

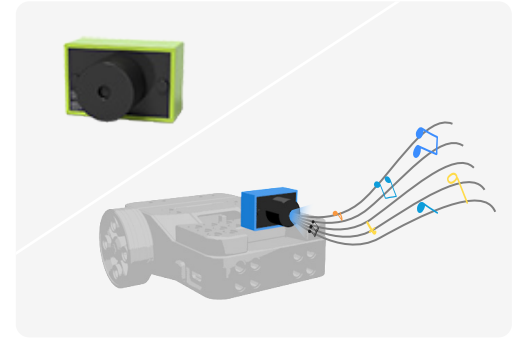

Buzzer

A buzzer is an audio signaling device. Typical uses of buzzers include alarm devices, timers, and playing musical notes.

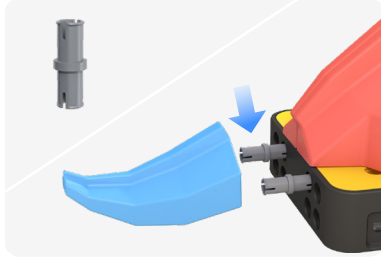

Pin

Double pins at both ends

It can be used for connections between part and part, part and Hub in most cases. It can also be used as a small axle providing free rotation.

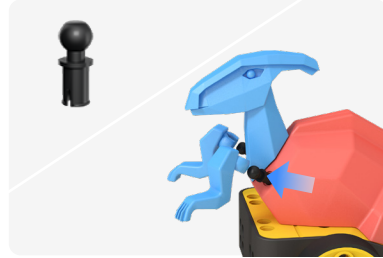

Ball Pin

With a ball head at one end

It can be used on part or link that rotates in nearly 360°.

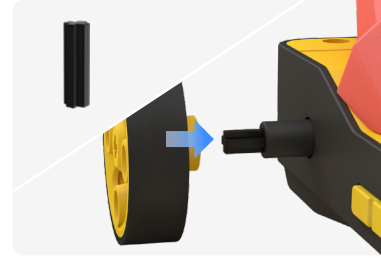

Axle

Double cross-shape ends

It can be used for connections between part and part, part and axle slots on the Hub. It transfers the rotation of the motor to wheels, links or other parts.

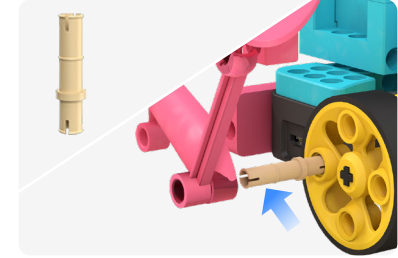

Long Pin

One longer end pin

It can be used for connections among multiple parts. Links can be set next to each other with free rotation.



Note



The plier is used to unplug the connectors for safety issue, and to avoid damages to parts.

Windows PC Download

🔍 www.ime3d.com/downloads

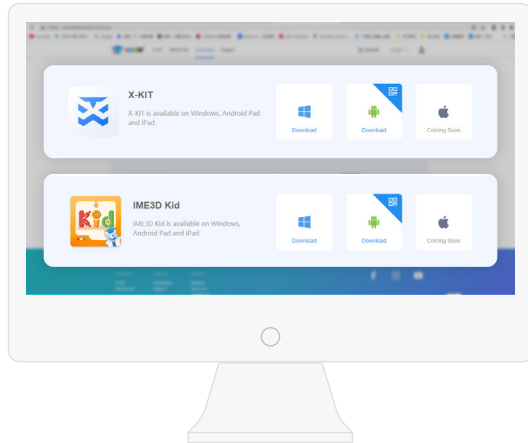

Android Tablet / iPad Download

🔍 Search "X-KIT" in Google Play or App Store

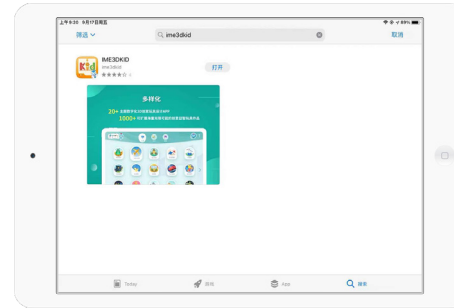

Note

X-KIT APP is always free for trial and updates!

Setting

Set email / BGM / Sound Effect

Robot templates

Preview and pick the 60+ robot designs

Robot categories

Animal Kingdom / Vehicle League
Construction Group / Fantasy Show

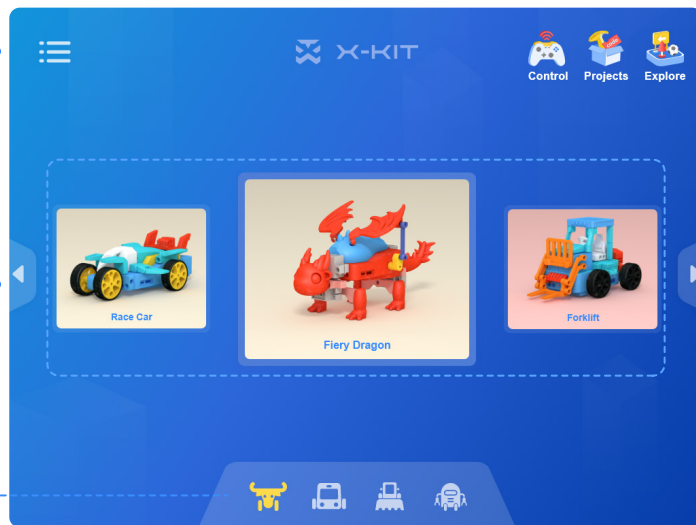

Projects

User-created design and coding works are saved here



Remote control

A wireless control panel provides full control over robots



Explore

Latest news, tutorial, gameplay updates are posted here

X-KIT contains **60+** robots from 4 categories for kids to pick from.



Animal Kingdom



Vehicle League



Construction Group



Fantasy Show

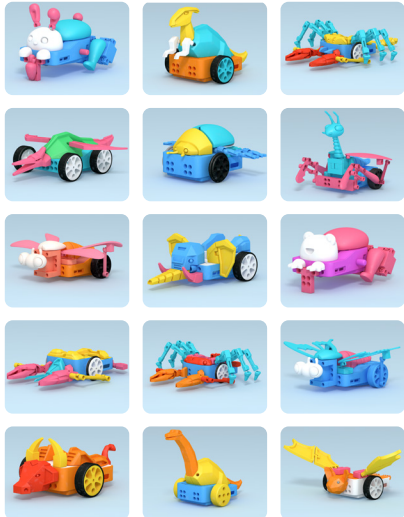

Return to Homepage [Back Arrow]

Robot description [Parasaurulophus description]

Building Instruction
Step by step instruction of the assembling of selected robot [Building Instruction button]

Parts list
Lists of 3D printed parts and electronic modules [Parts List icon]

Robot 3D preview
A 3D model of the robot can be previewed here [3D Model]

Go to coding
Forward to coding mode [Code button]

Print
Print the parts of selected robot by saving the parts into a STL file and sending it to a 3D printer [Print button]

Robot design
Make design modification based on selected robot template [Design button]

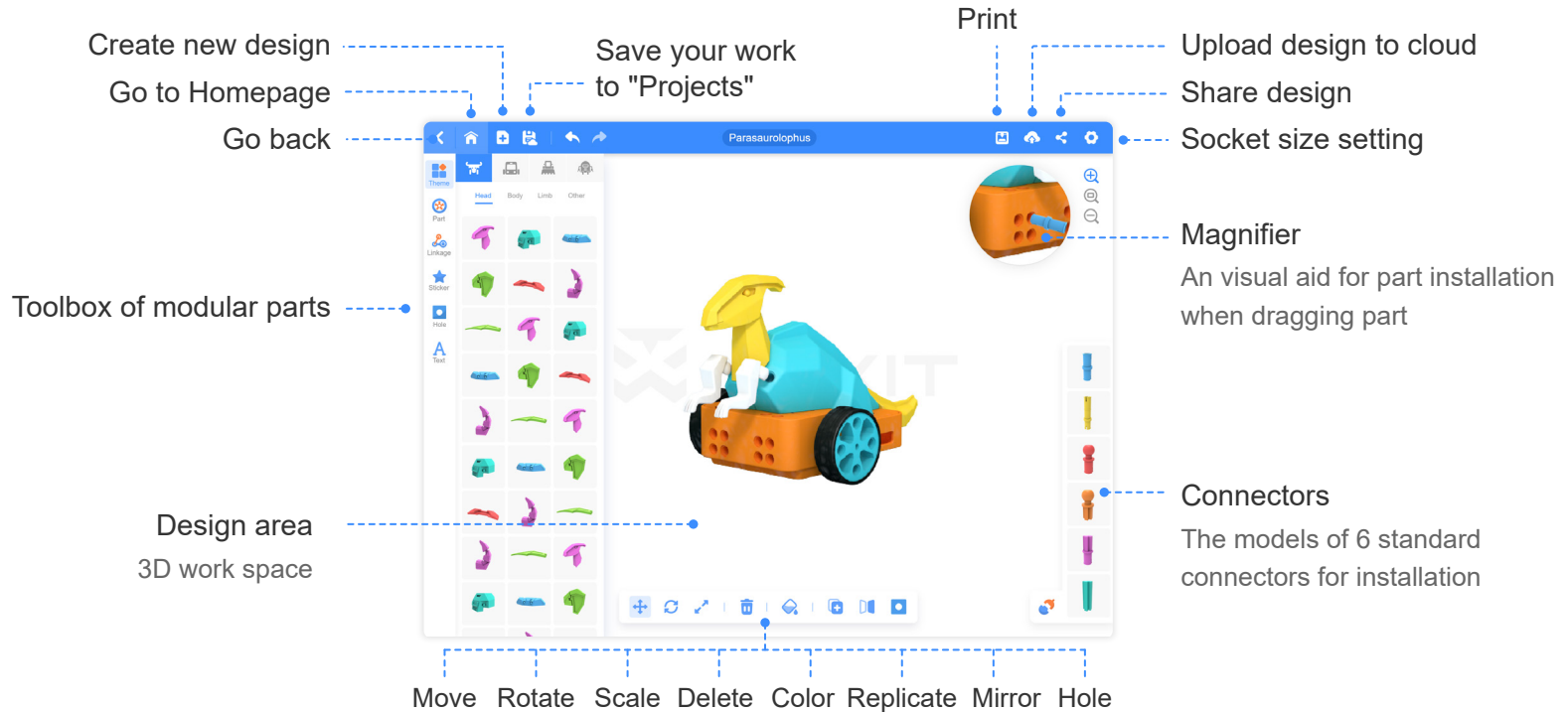

Note

In the real world, in order to fit the connectors, any part with pre-made holes can not be scaled.

Includes parts of 60+ robot templates. The modules can be used for brand new design

Includes models of wheel and electronic modules as ultrasound sensor, servo or servo pack

Includes various modular parts as links or LEGO parts

Includes various fun stickers to stick on and merge into most parts without using connectors

Includes hole tool to make standard sockets on model

Includes Text tool to generate custom text stickers

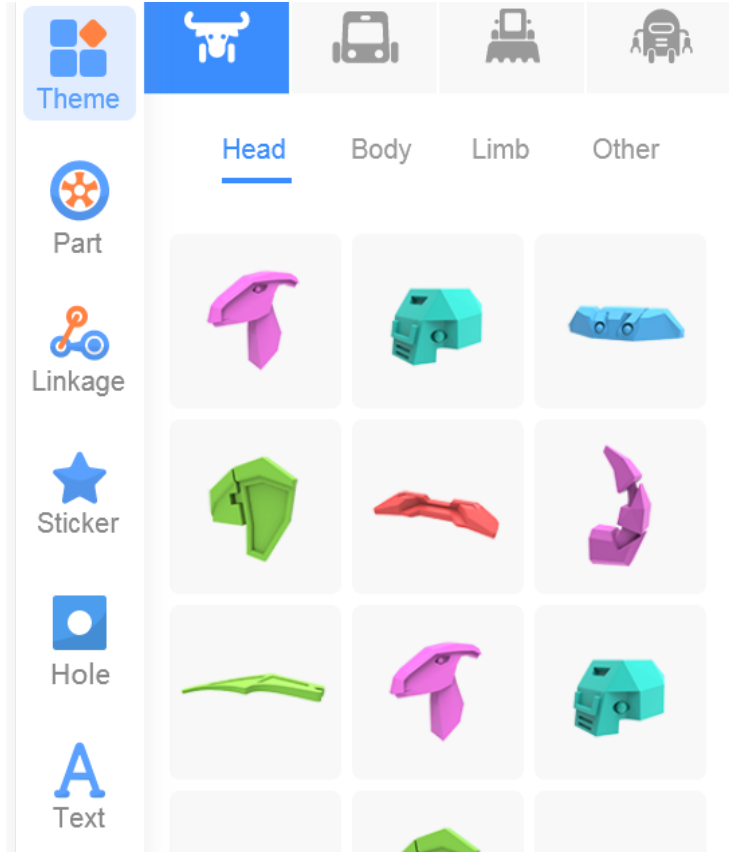

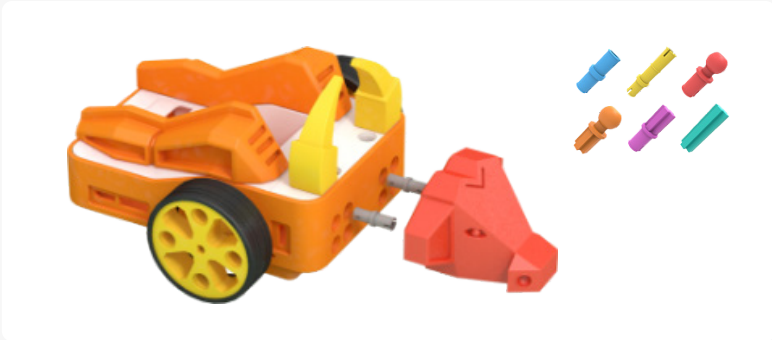

It is required to use connectors to install parts onto the Hub or connect part to part. There are 6 types of connector model in the connector tool box. Stickers and texts don't need connectors.

[Refer to page 10 for the usage of connectors](#)

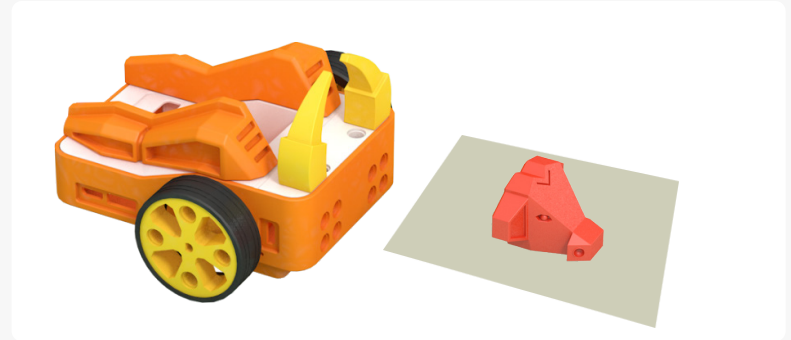

When parts fail to be installed, they will drop on a work plane. You can edit and then reinstall them, or delete them.

There are two different coding modes after pressing  code

Card Coding

An easy-to-learn coding app which allows pre-school kids to taste the fun of coding.

Only on Android Tablet / Windows PC

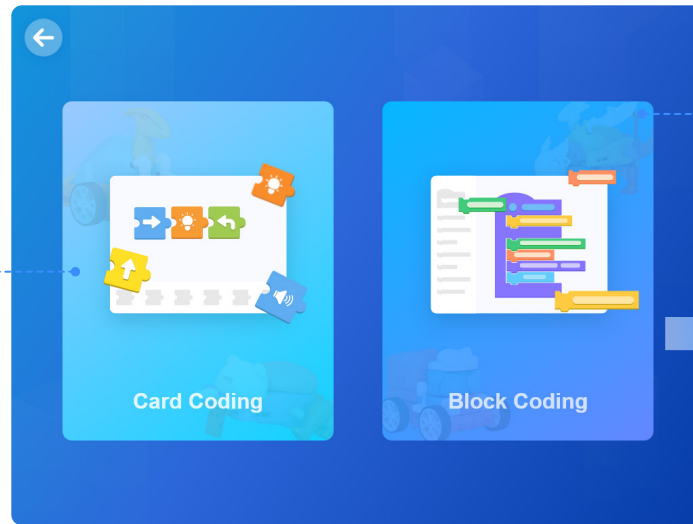

Block Coding

More powerful but still very intuitive block coding allows users of all ages to freely control their robot through coding.

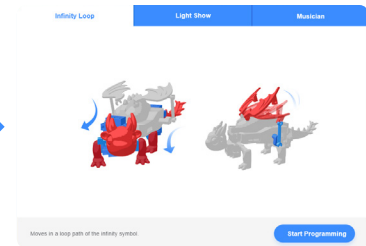

There are 3 premade codes in each robot template for users to directly use in the robot. And users can make modification based on them as well.

40+ premade codes are prepared in the Code Library for users to use in their robots directly.



The image shows a graphical coding interface with several key components and annotations:

- Navigation and Project Management:** Buttons for "Create new code", "Back to Homepage", "Go back", "Save to 'Projects'", "Control", and "Connect Hub" are located at the top of the interface.
- Coding Block Toolbox:** A vertical sidebar on the left contains icons for Action, Judge, Loop, Math, Variable, and Function. A callout states: "Coding block toolbox Includes X-KIT coding blocks, variables and other custom coding blocks".
- Case Library:** A button at the bottom left is labeled "Case Library" with a callout: "Case Library 40+ premade codes are for users to directly use or modify".
- Code Editor:** The central workspace shows a script named "doSomething" with blocks for setting servo angles (No1, No2) and pausing execution (500ms).
- Plugins Diagram:** A large blue diagram on the right shows a foldable schematic of an electronic module with components like Ultrasonic, Servo, Buzzer, and M1/M2. A callout states: "Plugins Diagram of electronic module connection A foldable diagram guides you to connect electronic modules".
- Execution and Upload:** A yellow "Start/Stop" button is located at the bottom right of the code editor. A callout states: "Start/Stop code Transferred codes in the hub can be started or stopped by pressing this button". Below it is an "Upload code" button with a callout: "Upload code Upload your code to the hub".

Start / Stop custom code

Transferred codes in the hub can be started or stopped by pressing this button

Go back

Preset motions

6 preset motions of the Hub can be activated instantly

Directional pad

Move the "Directional button" around to control the motion of the Hub

Flip direction

Flip the forward direction as needed

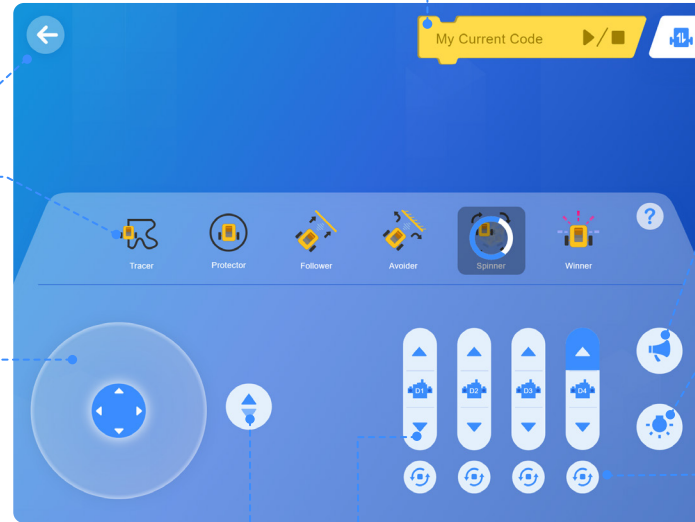
**Connect Hub**

The Bluetooth signal will be on when the Hub is successfully connected.

Buzzer

Buzz your buzzer. The Buzzer module need to be connected.

RGB lights

Light up your RGB lights underneath the hub.

Reset servo

Reset the servo to turn to its original position (90°).

Servo control

Press ▲ to let servo rotate to its 0° position.

Press ▼ to let servo rotate to its 180° position.

Long pressing makes the servo rotate continuously.

There are **6** pre-programmed motions in the Remote-Control mode.

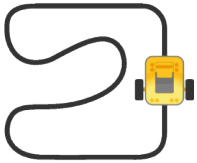

Tracer

The Tracer auto-traces the black line in the court using the IR sensors embedded.



Protector

The Protector patrols only in the territory inside the black circle.



Avoider

The Avoider bypasses an obstacle every time it encounters one.



Follower

The Follower keeps a fixed distance to the object it follows.



Spinner

The Spinner spins in an increasing speed and then slow down till it stops.



Winner

The Winner celebrates by moving in a path of letter "V" with lights flashing.



Note

Press Tracer / Protector / Follower: Avoider to start motion, press again to stop.
Spinner / Winner: will run until it finishes its motion.

New project

Brand new design, card code or block code can be created here

My designs

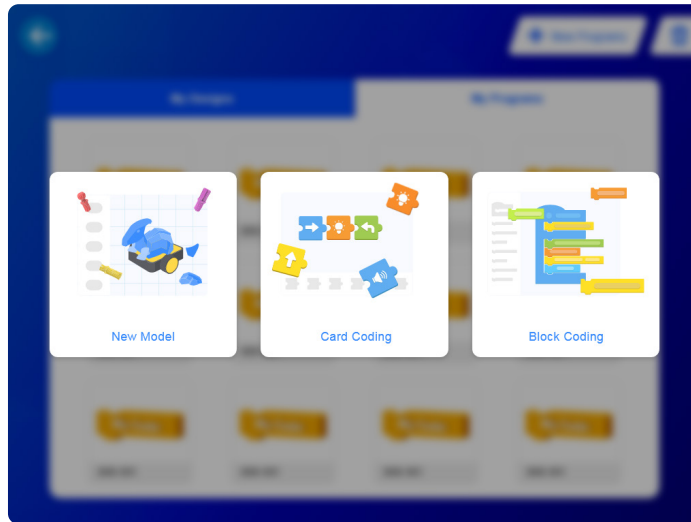
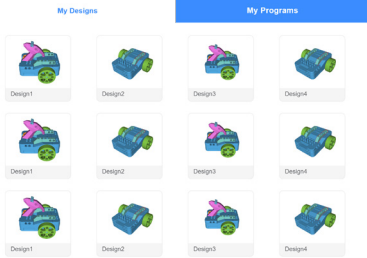

My codes

There are 2 code files due to 2 coding modes. Distinguish them by the icons.



Card Code



Block Code

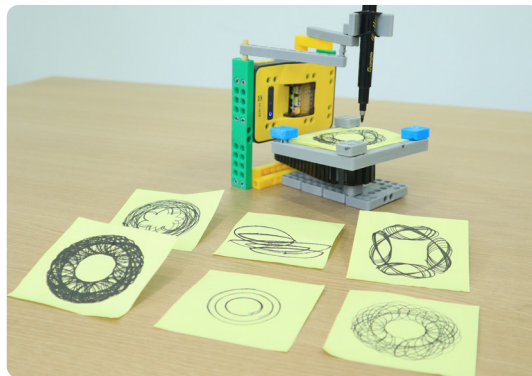
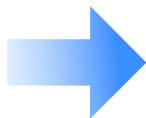

Geometry Painter



Foraging Dinosaurs



Rover Drone



Show Stand

Latest updates of gameplay tutorial and news are here!

1: Can I still use X-KIT without a 3D printer?

Without a 3D printer, our user can control the hub and the electric modules to perform basic motions. However, the point of X-KIT is to let more people get close with 3D design and 3D printing and enjoy the power from them.

If you are not currently with a 3D printer, you might:

1. Download your .STL (3D model) file on PC and take it to a friends' or colleagues' 3D printer.
2. Export to Shapeways or i.materialise: Professional service bureaus who will produce your print on their own production floor and send to you, and of course there needs payment.
3. Get yourself a 3D printer permanently is never too late! 3D printing is truly a versatile and handy tool at home. Not even mention that we

2: What device does X-KIT app support?

Windows PC, iPad and Android tablets are all workable.

3: What's the minimum printed size of a 3D

100*100mm (3.94*3.94inch) is good enough for up to 98% of the parts. Our current biggest part is around 120mm (4.72inch) in its length, very rare case though.

4: Will the robot list be expanded in the future so it does not get too stale?

We absolutely got this. If you are following our Facebook page, you would know there are tons of idea that we are trying to convert into new models. The robot list keeps updating for sure. Not only this, more ways of play and new activities will be released in the Explore page in the app.

This device complies with part 15 of the FCC Rules. Operation is subject to the following two conditions: (1) this device may not cause harmful interference, and (2) this device must accept any interference received, including interference that may cause undesired operation.

Any changes or modifications not expressly approved by the party responsible for compliance could void the user's authority to operate the equipment.

NOTE: This equipment has been tested and found to comply with the limits for a Class B digital device, pursuant to Part 15 of the FCC Rules. These limits are designed to provide reasonable protection against harmful interference in a residential installation. This equipment generates, uses and can radiate radio frequency energy and, if not installed and used in accordance with the instructions, may cause harmful interference to radio communications.

However, there is no guarantee that interference will not occur in a particular installation.

If this equipment does cause harmful interference to radio or television reception, which can be determined by turning the equipment off and on, the user is encouraged to try to correct the interference by one or more of the following measures:

- Reorient or relocate the receiving antenna.
- Increase the separation between the equipment and receiver.
- Connect the equipment into an outlet on a circuit different from that to which the receiver is connected.
- Consult the dealer or an experienced radio/TV technician for help.

The device has been evaluated to meet general RF exposure requirement. The device can be used in portable exposure condition without restriction

For how-to videos and further supports:

🔍 <https://en.ime3d.com/Support>

Follow us on:



@IME3D2011



@IME3D2011



@IME3D2011

Name: IME3D X-KIT

Model: V4.0

Mfr: Aowei (Shanghai) Digital Technology Co., Ltd

Tel: +86-21-60719032

Add: 12-301,NO.1895 Hutai Road,Creative park Shanghai,P.R.China



WARNING:



CHOCKING HAZARO_Small Parts not for
children under 3 years old