

## TEST REPORT

**Applicant:** Shenyang Sanfeng Intelligent Technology Co., Ltd

**Address:** No. 10-1 (1-28-12), Hunnan West Road, Hunnan District,  
Shenyang City, Liaoning Province, China

**Product Name:** Cell Phone Signal Booster

**FCC ID:** 2A34B-SFZN006

**Standard(s):** 47 CFR Part 20.21  
ANSI C63.26-2015  
KDB 935210 D03 Signal Booster Measurements v04r04

**Report Number:** SSH1240116-03495E-RF-00A

**Report Date:** 2024/3/13

The above device has been tested and found compliant with the requirement of the relative standards by Bay Area Compliance Laboratories Corp. (Dongguan).

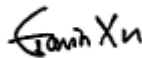

**Reviewed By:** Gavin Xu  
Title: RF Engineer



**Approved By:** Ivan Cao  
Title: EMC Manager

---

**Bay Area Compliance Laboratories Corp. (Dongguan)**  
No.12, Pulong East 1<sup>st</sup> Road, Tangxia Town, Dongguan, Guangdong, China

Tel: +86-769-86858888

Fax: +86-769-86858891

[www.baclcorp.com.cn](http://www.baclcorp.com.cn)

Note: The information marked ▲ is provided by the applicant, the laboratory is not responsible for its authenticity and this information can affect the validity of the result in the test report. Unless otherwise stated the results shown in this test report refer only to the sample(s) tested. This report cannot be reproduced except in full, without prior written approval of the Company. This report is valid only with a valid digital signature. The digital signature may be available only under the Adobe software above version 7.0. This report may contain data that are not covered by the accreditation scope and shall be marked with ★. This report must not be used by the client to claim product certification, approval, or endorsement by NVLAP, NIST, or any agency of the U.S. Government.

# CONTENTS

<b>DOCUMENT REVISION HISTORY</b> .....	<b>4</b>
<b>1. GENERAL INFORMATION</b> .....	<b>5</b>
<b>1.1 GENERAL DESCRIPTION OF EQUIPMENT UNDER TEST</b> .....	<b>5</b>
<b>1.2 ACCESSORY INFORMATION</b> .....	<b>5</b>
<b>1.3 ANTENNA AND KITTING INFORMATION DETAIL▲</b> .....	<b>6</b>
<b>1.4 EQUIPMENT MODIFICATIONS</b> .....	<b>6</b>
<b>2. DESCRIPTION OF TEST CONFIGURATION</b> .....	<b>7</b>
<b>2.1 EUT OPERATION CONDITION</b> .....	<b>7</b>
<b>2.2 EUT EXERCISE SOFTWARE</b> .....	<b>7</b>
<b>2.3 SUPPORT EQUIPMENT LIST AND DETAILS</b> .....	<b>7</b>
<b>2.4 SUPPORT CABLE LIST AND DETAILS</b> .....	<b>7</b>
<b>2.5 BLOCK DIAGRAM OF TEST SETUP</b> .....	<b>7</b>
<b>2.6 TEST FACILITY</b> .....	<b>8</b>
<b>2.7 MEASUREMENT UNCERTAINTY</b> .....	<b>8</b>
<b>3. SUMMARY OF TEST RESULTS</b> .....	<b>9</b>
<b>4. REQUIREMENTS AND TEST RESULT</b> .....	<b>10</b>
<b>4.1 AUTHORIZED FREQUENCY BAND VERIFICATION</b> .....	<b>10</b>
4.1.1 Applicable Standard .....	10
4.1.2 Test Procedure .....	10
4.1.3 Test Result .....	11
<b>4.2 MAXIMUM POWER MEASUREMENT</b> .....	<b>14</b>
4.2.1 Applicable Standard .....	14
4.2.2 Test Procedure .....	14
4.2.3 Test Result .....	16
<b>4.3 MAXIMUM BOOSTER GAIN COMPUTATION</b> .....	<b>19</b>
4.3.1 Applicable Standard .....	19
4.3.2 Test Procedure .....	19
4.3.3 Test Result .....	20
<b>4.4 INTERMODULATION PRODUCT</b> .....	<b>22</b>
4.4.1 Applicable Standard .....	22
4.4.2 Test Procedure .....	22
4.4.3 Test Result .....	23
<b>4.5 OUT OF BAND EMISSIONS</b> .....	<b>27</b>
4.5.1 Applicable Standard .....	27
4.5.2 Test Procedure .....	27
4.5.3 Test Result .....	29
<b>4.6 SPURIOUS EMISSIONS AT ANTENNA TERMINALS</b> .....	<b>50</b>
4.6.1 Applicable Standard .....	50
4.6.2 Test Procedure .....	50
4.6.3 Test Result .....	52

**4.7 NOISE LIMITS** ..... **63**

    4.7.1 Applicable Standard ..... 63

    4.7.2 Test Procedure ..... 63

    4.7.3 Maximum transmitter noise power level ..... 63

    4.7.4 Variable uplink noise timing ..... 64

    4.7.5 Test Result ..... 65

**4.8 UPLINK INACTIVITY** ..... **72**

    4.8.1 Applicable Standard ..... 72

    4.8.2 Test Procedure ..... 72

    4.8.3 Test Result ..... 73

**4.9 VARIABLE BOOSTER GAIN** ..... **75**

    4.9.1 Applicable Standard ..... 75

    4.9.2 Test Procedure ..... 75

    4.9.3 Test Result ..... 77

**4.10 OCCUPIED BANDWIDTH** ..... **81**

    4.10.1 Applicable Standard ..... 81

    4.10.2 Test Procedure ..... 81

    4.10.3 Test Result ..... 82

**4.11 OSCILLATION DETECTION** ..... **94**

    4.11.1 Applicable Standard ..... 94

    4.11.2 Test Procedure ..... 94

    4.11.3 Test Result ..... 97

**4.12 RADIATED SPURIOUS EMISSIONS** ..... **106**

    4.12.1 Applicable Standard ..... 106

    4.12.2 Test Procedure ..... 106

    4.12.3 Test Result ..... 107

**APPENDIX A - EUT PHOTOGRAPHS** ..... **118**

**APPENDIX B - TEST SETUP PHOTOGRAPHS** ..... **119**

**APPENDIX C - RF EXPOSURE EVALUATION** ..... **120**

**APPLICABLE STANDARD** ..... **120**

**CALCULATION FORMULA:** ..... **120**

**CALCULATED DATA:** ..... **121**

## DOCUMENT REVISION HISTORY

Revision Number	Report Number	Description of Revision	Date of Revision
1.0	SSH1240116-03495E-RF-00A	Original Report	2024/3/13

## 1. GENERAL INFORMATION

### 1.1 General Description Of Equipment under Test

<b>EUT Name:</b>	Cell Phone Signal Booster
<b>Equipment Type:</b>	Fixed Wideband Consumer Signal Booster
<b>EUT Model:</b>	SF006A
<b>Multiple Models:</b>	SF006B
<b>Rated Input Voltage:</b>	DC 12V from adapter
<b>Serial Number:</b>	2G05-5(Model: SF006A) 2G05-6(Model: SF006B)
<b>EUT Received Date:</b>	2024/1/26
<b>EUT Received Status:</b>	Good
<p>Note: The multiple models are electrically identical with the test model. The difference is only this model integrates indoor antenna in the shell, Please refer to the declaration letter for more detail, which was provided by manufacturer. All RF conducted test performed with the Model: SF006A, and radiation emission tested with the two models.</p>	

### Operation Band:

Bands	Uplink Frequency (MHz)	Downlink Frequency (MHz)
Lower 700	698-716	728-746
Upper 700	776-787	746-757
Cellular	824-849	869-894
AWS-1	1710-1755	2110-2155
PCS	1850-1915	1930-1995

### 1.2 Accessory Information

Accessory Description	Manufacturer	Model	Parameters
Adapter	SHENZHEN TEKA TECHNOLOGY CO.,LTD.	TEKA-TD120200US	Input: AC 100-240V 50/60Hz,0.7A MAX Output: DC 12V,2A

### 1.3 Antenna And Kitting Information Detail▲

EUT has multiple sets antenna kitting for marketing, the antenna gain for varied band were listed in user manual, fulfill the requirement of FCC Part 20.21(e)(8)(i)(G), more detail information please refer to the user manuals.

Component	Type Specification	Antenna Gain/Cable Loss				
		Lower 700	Upper 700	Cellular	AWS-1	PCS
Outdoor Cable	4D-FB 60Feet	3.9dB	4.1dB	4.1dB	6.7dB	6.9dB
Outdoor Cable	RG6 60Feet	3.2dB	3.4dB	3.4dB	5.1dB	5.2dB
Outdoor Cable	RG6 30Feet	1.6dB	1.7dB	1.7dB	3.3dB	2.6dB
Indoor Cable	RG6 30Feet	1.6dB	1.7dB	1.7dB	4.2dB	2.6dB
Indoor Cable	RG6 15Feet	0.8dB	0.85dB	0.85dB	2.1dB	1.3dB
Outdoor Antenna	A0103SF	5.6dBi	6.7dBi	7.1dBi	7.9dBi	8.0dBi
Outdoor Antenna	A0104SF	6.6dBi	6.6dBi	6.5dBi	7.2dBi	7.0dBi
Indoor Antenna	A0501SF	5.1dBi	3.8dBi	4.5dBi	6.4dBi	8.8dBi
Indoor Antenna	A0502SF	5.57dBi	5.79dBi	5.91dBi	7.61dBi	6.91dBi
Indoor Antenna	A0801SF	-1.3dBi	1.6dBi	1.8dBi	2.9dBi	2.2dBi

Note: Indoor antenna A0801SF connects the booster direct, and A0502SF is Integrated antenna in model SF006B, not use the indoor cable.

### 1.4 Equipment Modifications

No modifications are made to the EUT during all test items.

## 2. DESCRIPTION OF TEST CONFIGURATION

### 2.1 EUT Operation Condition

The system was configured for testing in Engineering Mode according to KDB 935210 D03 Signal Booster Measurements v04r04, which was provided by the manufacturer.

### 2.2 EUT Exercise Software

No software was used during test.

### 2.3 Support Equipment List and Details

Manufacturer	Description	Model	Serial Number
Unknown	Load	Unknown	Unknown
Unknown	Adapter	TEKA-TD120200US	Unknown
Agilent	MXG Vector Signal Generator	N5182B	MY51350142

### 2.4 Support Cable List and Details

Cable Description	Shielding Type	Ferrite Core	Length (m)	From Port	To
DC Cable	No	No	1.2	Adapter	EUT
RF Cable	No	No	0.2	EUT	Load
RF Cable	No	No	2	N5182B	EUT

### 2.5 Block Diagram of Test Setup

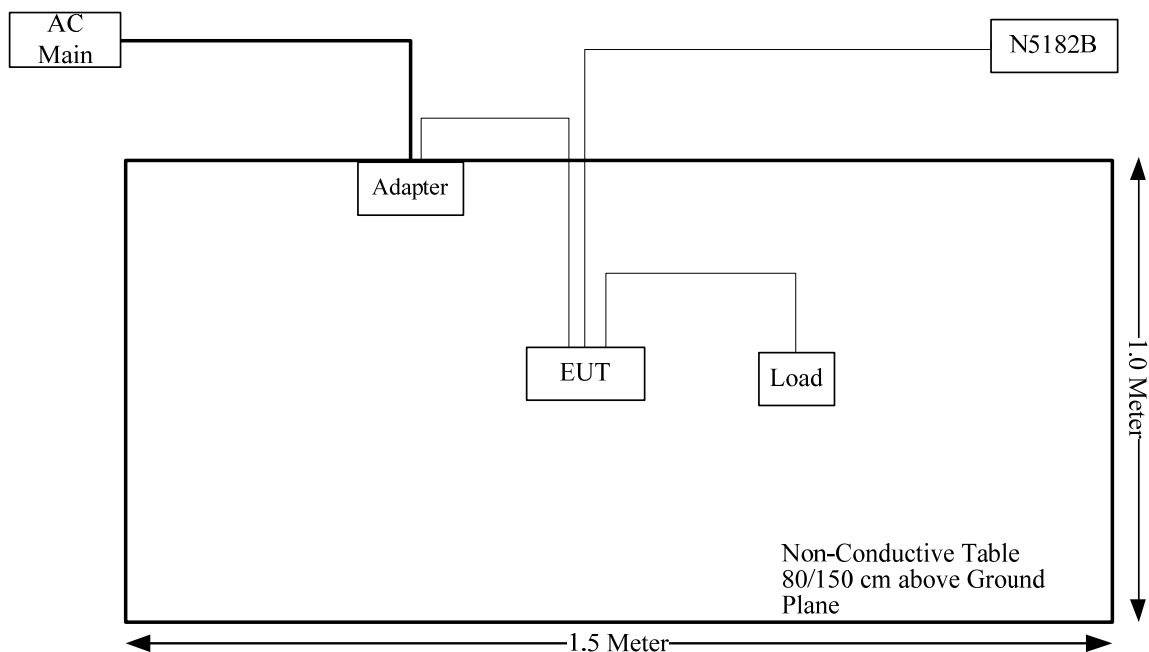

## 2.6 Test Facility

The Test site used by Bay Area Compliance Laboratories Corp. (Dongguan) to collect test data is located on the No.12, Pulong East 1st Road, Tangxia Town, Dongguan, Guangdong, China.

The lab has been recognized as the FCC accredited lab under the KDB 974614 D01 and is listed in the FCC Public Access Link (PAL) database, FCC Registration No. : 829273, the FCC Designation No. : CN5044.

The lab has been recognized by Innovation, Science and Economic Development Canada to test to Canadian radio equipment requirements, the CAB identifier: CN0022.

## 2.7 Measurement Uncertainty

Otherwise required by the applicant or Product Regulations, Decision Rule in this report did not consider the uncertainty. The extended uncertainty given in this report is obtained by combining the standard uncertainty times the coverage factor K with the 95% confidence interval.

Parameter	Measurement Uncertainty
Occupied Channel Bandwidth	±5 %
RF output power, conducted	±0.61dB
Power Spectral Density, conducted	±0.61 dB
Unwanted Emissions, radiated	9kHz~30MHz: 3.3dB, 30MHz~200MHz: 4.55 dB, 200MHz~1GHz: 5.92 dB, 1GHz~6GHz: 4.98 dB, 6GHz~18GHz: 5.89 dB, 18GHz~26.5GHz:5.47 dB, 26.5GHz~40GHz:5.63 dB
Unwanted Emissions, conducted	±2.47 dB
Temperature	±1 °C
Humidity	±5%
DC and low frequency voltages	±0.4%
Duty Cycle	1%
AC Power Lines Conducted Emission	3.11 dB (150 kHz to 30 MHz)



### 3. SUMMARY OF TEST RESULTS

Standard(s) Section	Test Items	Result
§20.21(e)(3)	Authorized Frequency Band Verification	Compliant
§ 20.21(e)(8)(i)(D) § 20.21(e)(8)(i)(B) §20.21(e)(4)	Maximum Power Measurement	Compliant
§ 20.21(e)(8)(i)(C)(2)(i) § 20.21(e)(8)(i)(B) §20.21(e)(4)	Maximum Booster Gain Computation	Compliant
§ 20.21(e)(8)(i)(F)	Intermodulation Product	Compliant
§ 20.21(e)(8)(i)(E)	Out Of Band Emissions	Compliant
§2.1051	Spurious Emissions At Antenna Terminals	Compliant
§ 20.21(e)(8)(i)(A)(1)(i) § 20.21(e)(8)(i)(H) §20.21(e)(4)	Noise Limits	Compliant
§ 20.21(e)(8)(i)(I) §20.21(e)(4)	Uplink Inactivity	Compliant
§ 20.21(e)(8)(i)(C)(1) § 20.21(e)(8)(i)(H)	Variable Booster Gain	Compliant
§ 2.1049	Occupied Bandwidth	Compliant
§ 20.21(e)(8)(ii)(A) §20.21(e)(5)	Oscillation Detection	Compliant
§2.1053	Radiated Spurious Emissions	Compliant
§ 20.21(e)(8)(i)(B) § 20.21(e)(3)	Spectrum block filtering test procedure	Not applicable

Note:

Not applicable: This item only for wideband consumer boosters using spectrum block filtering.

## 4. REQUIREMENTS AND TEST RESULT

### 4.1 Authorized Frequency Band Verification

#### 4.1.1 Applicable Standard

According to § 20.21(e)(3) *Frequency Bands*.

This test is intended to confirm that the signal booster only operates on the CMRS frequency bands authorized for use by the NPS. In other words, the signal booster shall reject amplification of other signals outside of its passband. In addition, this test will identify the frequency at which the maximum gain is realized within each CMRS operational band, which then serves as a basis for subsequent tests.

#### 4.1.2 Test Procedure

KDB 935210 D03 Signal Booster Measurements v04r04 Clause 7.1

- a) Connect the EUT to the test equipment as shown in **Figure 1**. Begin with the uplink output (donor) port connected to the spectrum analyzer.
- b) Set the spectrum analyzer resolution bandwidth (RBW) for 100 kHz with the video bandwidth (VBW)  $\geq 3$  the RBW, using a PEAK detector with the MAX HOLD function.
- c) Set the center frequency of the spectrum analyzer to the center of the operational band under test with a span of 1 MHz.
- d) Set the signal generator for CW mode and tune to the center frequency of the operational band under test.
- e) Set the initial signal generator power to a level that is at least 6 dB below the AGC level specified by the manufacturer.
- f) Slowly increase the signal generator power level until the output signal reaches the AGC operational level.
- g) Reduce the signal generator power to a level that is 3 dB below the level noted above, then manually reset the EUT (e.g., cycle ac/dc power).
- h) Reset the spectrum analyzer span to 2 the width of the CMRS band under test. Adjust the tuned frequency of the signal generator to sweep 2 the width of the CMRS band using the sweep function. The AGC must be deactivated throughout the entire sweep.
- i) Using three markers, identify the CMRS band edges and the frequency with the highest power. Affirm that the values of all markers are visible on the display of the spectrum analyzer (e.g., marker table set to on).
- j) Capture the spectrum analyzer trace for inclusion in the test report.
- k) Repeat 7.1c) to 7.1j) for all operational uplink and downlink bands.

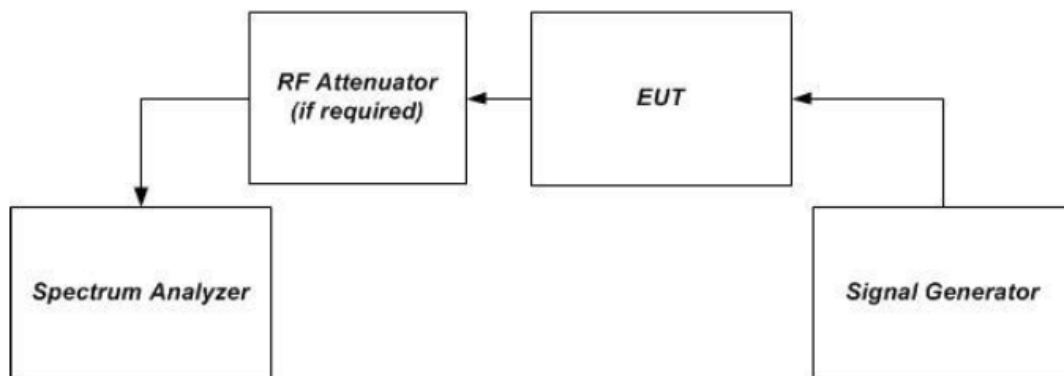

**Figure 1 – Band verification test instrumentation setup**

**4.1.3 Test Result**

Serial Number:	2G05-5	Test Date:	2024/2/21~2024/2/23
Test Site:	RF	Test Mode:	Transmitting
Tester:	Stu Song	Test Result:	Pass

**Environmental Conditions:**

Temperature: (°C)	24.2~26.3	Relative Humidity: (%)	42~64	ATM Pressure: (kPa)	100.7~101.5
----------------------	-----------	------------------------------	-------	------------------------	-------------

**Test Equipment List and Details:**

Manufacturer	Description	Model	Serial Number	Calibration Date	Calibration Due Date
R&S	Spectrum Analyzer	FSU 26	200160/026	2023/10/18	2024/10/17
yzjingcheng	Coaxial Cable	KTRFBU-141-50	41010012	2023/9/1	2024/8/31
yzjingcheng	Coaxial Cable	KTRFBU-141-50	41010013	2023/9/1	2024/8/31
Eastsheep	Coaxial Attenuator	5W-N-JK-6G-10dB	F-08-EM502	2023/9/10	2024/9/9
Agilent	MXG Vector Signal Generator	N5182B	MY51350142	2023/9/1	2024/8/31

\* Statement of Traceability: Bay Area Compliance Laboratories Corp. (Dongguan) attests that all calibrations have been performed, traceable to National Primary Standards and International System of Units (SI).

**Test Data:**

Modes	Operation Band	Bandedge Lower Frequency (MHz)	Bandedge Upper Frequency (MHz)	Highest Power Frequency (MHz)
Uplink	Lower 700	698	716	704.577
	Upper 700	776	787	782.628
	Cellular	824	849	829.929
	AWS-1	1710	1755	1742.885
	PCS	1850	1915	1865.000
Downlink	Lower 700	728	746	742.885
	Upper 700	746	757	750.280
	Cellular	869	894	882.782
	AWS-1	2110	2155	2142.740
	PCS	1930	1995	1979.792

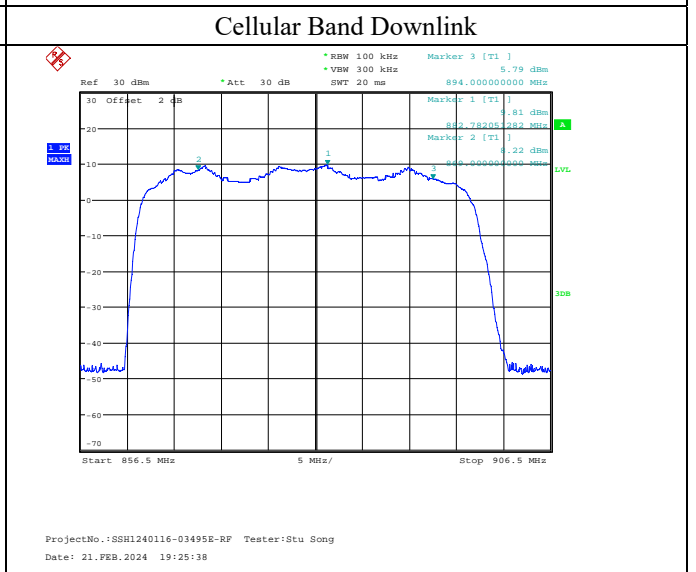
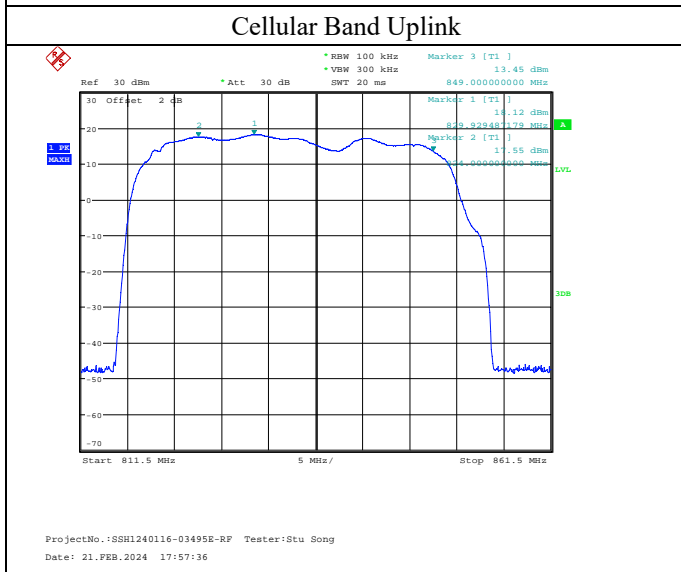
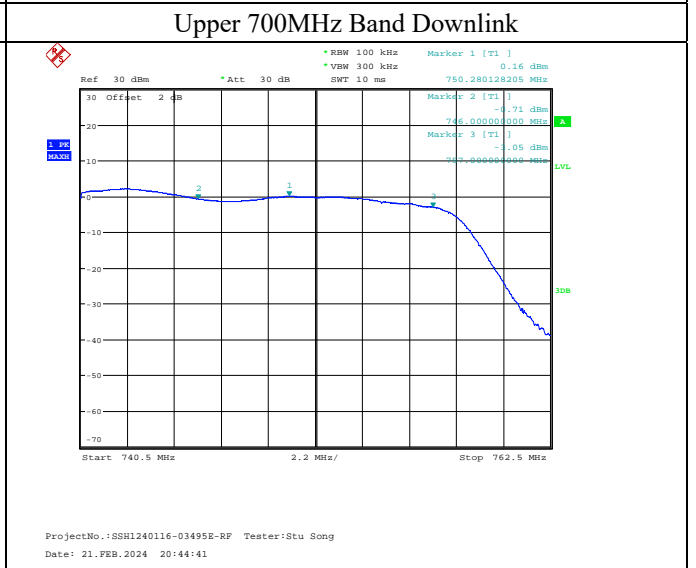
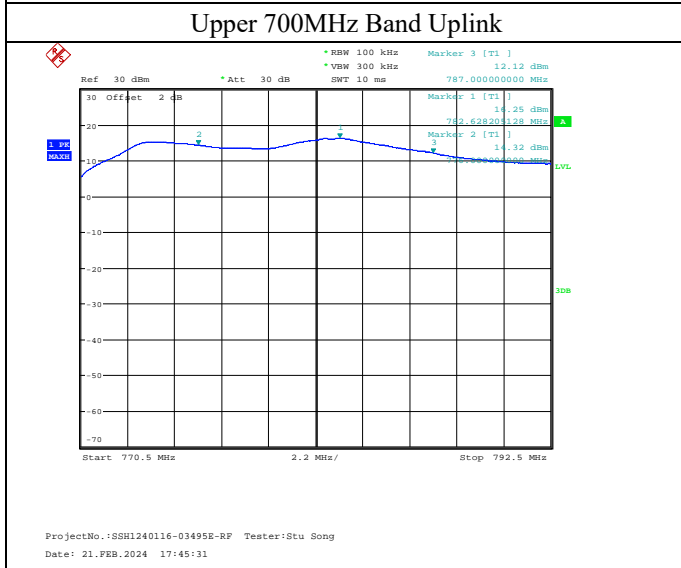
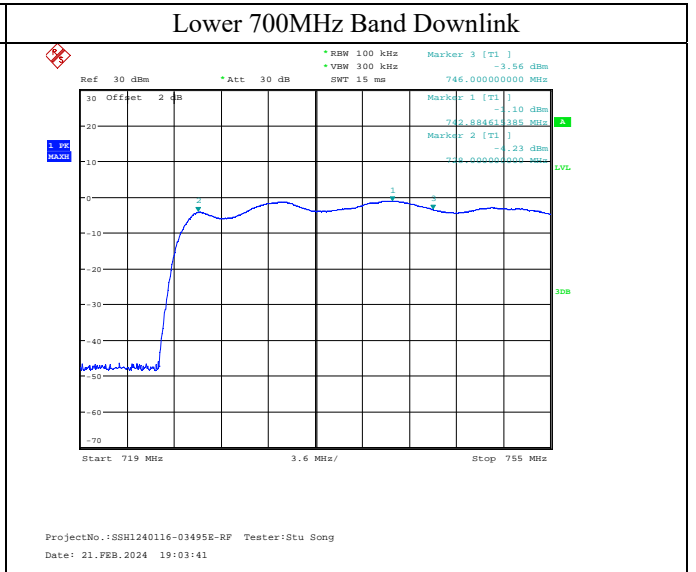
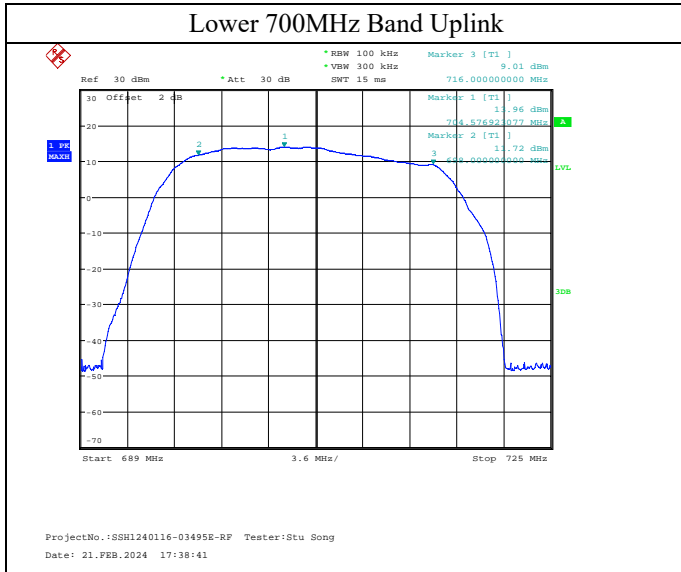

**AWS-1 Band Uplink**

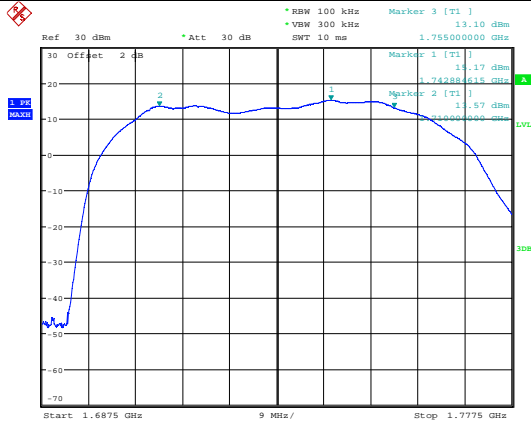

ProjectNo.:SSH1240116-03495E-RF Tester:Stu Song  
 Date: 21.FEB.2024 18:13:19

**AWS-1 Band Downlink**

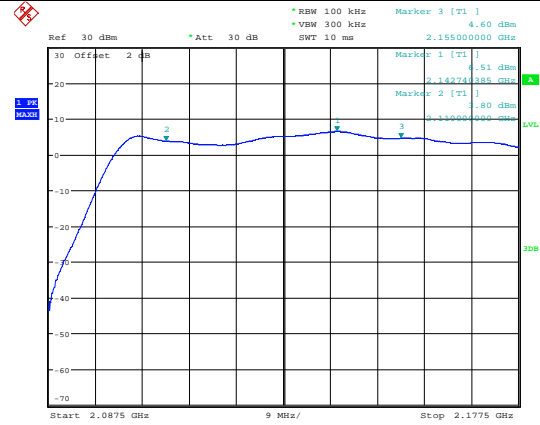

ProjectNo.:SSH1240116-03495E-RF Tester:Stu Song  
 Date: 21.FEB.2024 19:34:33

**PCS Band Uplink**

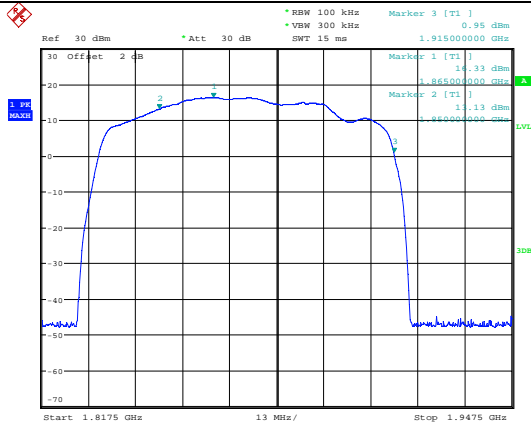

ProjectNo.:SSH1240116-03495E-RF Tester:Stu Song  
 Date: 21.FEB.2024 18:29:31

**PCS Band Downlink**

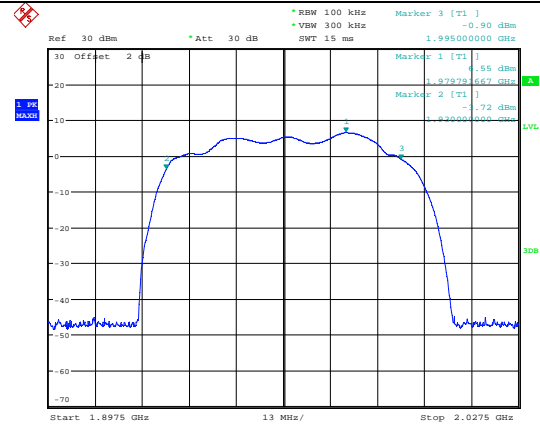

ProjectNo.:SSH1240116-03495E-RF Tester:Stu Song  
 Date: 21.FEB.2024 19:45:57

## 4.2 Maximum Power Measurement

### 4.2.1 Applicable Standard

According to § 20.21(e)(8)(i)(D) *Power Limits*; § 20.21(e)(8)(i)(B) *Bidirectional Capability* (uplink minimum conducted power output); §20.21(e)(4) *Self-monitoring*.

This procedure shall be used to demonstrate compliance to the signal booster power limits and requirements as specified in Sections 20.21(e)(8)(i)(D) and 20.21(e)(8)(i)(B) for wideband consumer signal boosters.

- a) Compliance to applicable EIRP limits must be shown using the highest gains from the list of antennas, cabling, and coupling devices declared by the manufacturer for use with the consumer booster.
- b) In addition, the maximum power levels measured in this procedure will be used in calculating the maximum gain as described in the next subclause.
- c) The frequency with the highest power level in each operational band as determined in 7.1 is to be measured discretely by applying the following procedure using the stated emission and power detector types independently.
- d) Use a signal generator to create a pulsed CW or GSM signal with a pulse width of 570  $\mu$ s and a duty cycle of 12.5% (i.e., one GSM timeslot), then measure using the burst power function of the measuring instrument.
- e) Use a signal generator to create an AWGN signal with a 99% occupied bandwidth (OBW) of 4.1 MHz, then measure using the channel power or band power function of the measuring instrumentation.
- f) All modes of operation must be verified to maintain operation within applicable limits at the maximum uplink and downlink test levels per device type as defined in 5.5, by increasing the power level in 2 dB steps from the AGC level to the maximum input level specified in 5.5.

### 4.2.2 Test Procedure

KDB 935210 D03 Signal Booster Measurements v04r04 Clause 7.2

- a) Connect the EUT to the test equipment as shown in **Figure 1**. Begin with the uplink output (donor) port connected to the spectrum analyzer.
- b) Configure the signal generator and spectrum analyzer for operation on the frequency determined in 7.1 with the highest power level, but with the center frequency of the signal no closer than 2.5 MHz from the band edge. The spectrum analyzer span shall be set to at least 10 MHz.
- c) Set the initial signal generator power to a level well below that which causes AGC activation.
- d) Slowly increase the signal generator power level until the output signal reaches the AGC operational limit (from observation of signal behavior on the spectrum analyzer; i.e., no further increase in output power as input power is increased).
- e) Reduce power sufficiently on the signal generator to ensure that the AGC is not controlling the power output.
- f) Slowly increase the signal generator power to a level just below (and within 0.5 dB of) the AGC limit without triggering the AGC. Note the signal generator power level as  $P_{in}$ .
- g) Measure the output power,  $P_{out}$ , with the spectrum analyzer as follows.
  - 1) Set RBW = 100 kHz for AWGN signal type, or 300 kHz for CW or GSM signal type.
  - 2) Set VBW  $\geq$  3\*RBW.
  - 3) Select either the BURST POWER or CHANNEL POWER measurement mode, as required for each signal type. For AWGN, the channel power integration bandwidth shall be the 99% OBW of the 4.1 MHz signal.
  - 4) Select the power averaging (rms) detector.
  - 5) Affirm that the number of measurement points per sweep  $\geq$  (2\*span)/RBW.

*NOTE—This requirement does not apply for BURST power measurement mode.*

- 6) Set sweep time = auto couple, or as necessary (but no less than auto couple value).
- 7) Trace average at least 100 traces in power averaging (i.e., rms) mode.
- 8) Record the measured power level  $P_{out}$ , with one set of results for the GSM or CW input stimulus, and another set of results for the AWGN input stimulus.
- h) Repeat step g) while increasing the signal generator amplitude in 2 dB steps until the maximum input level indicated in 5.5 is reached. If the booster has shut down at any point during the input power steps, it should be noted and step g) shall be repeated at an input level 1 dB less than that found to cause the shutdown. The test report shall include either a statement describing that the device complies at 10 dB above AGC or at the 5.5 power levels, or a table showing compliance at the additional input power(s) required.
- i) Repeat the entire procedure for each operational uplink and downlink frequency band supported by the booster.
- j) Provide tabulated results in the test report.

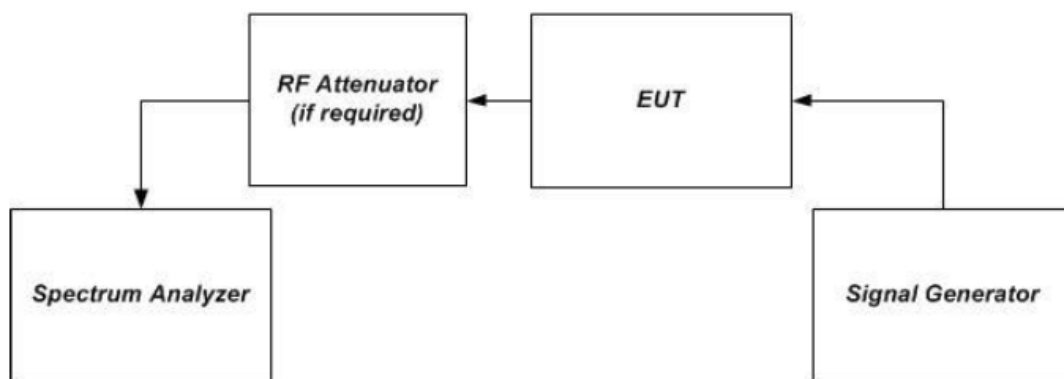

**Figure 1 – Band verification test instrumentation setup**

**4.2.3 Test Result**

Serial Number:	2G05-5	Test Date:	2024/2/21~2024/2/23
Test Site:	RF	Test Mode:	Transmitting
Tester:	Stu Song	Test Result:	Pass

**Environmental Conditions:**

Temperature: (°C)	24.2~26.3	Relative Humidity: (%)	42~64	ATM Pressure: (kPa)	100.7~101.5
----------------------	-----------	---------------------------	-------	------------------------	-------------

**Test Equipment List and Details:**

Manufacturer	Description	Model	Serial Number	Calibration Date	Calibration Due Date
R&S	Spectrum Analyzer	FSU 26	200160/026	2023/10/18	2024/10/17
yzjingcheng	Coaxial Cable	KTRFBU-141-50	41010012	2023/9/1	2024/8/31
yzjingcheng	Coaxial Cable	KTRFBU-141-50	41010013	2023/9/1	2024/8/31
Eastsheep	Coaxial Attenuator	5W-N-JK-6G-10dB	F-08-EM502	2023/9/10	2024/9/9
Agilent	MXG Vector Signal Generator	N5182B	MY51350142	2023/9/1	2024/8/31

*\* Statement of Traceability: Bay Area Compliance Laboratories Corp. (Dongguan) attests that all calibrations have been performed, traceable to National Primary Standards and International System of Units (SI).*

**Test Data:**

**AGC Input Level:**

Mode	Operation Band	Signal Type	AGC Input Level (dBm)
Uplink	Lower 700MHz	AWGN	-37.00
		GSM	-37.00
	Upper 700MHz	AWGN	-34.00
		GSM	-34.00
	Cellular	AWGN	-34.00
		GSM	-34.00
	AWS-1	AWGN	-39.00
		GSM	-39.00
	PCS	AWGN	-38.00
		GSM	-38.00
Downlink	Lower 700MHz	AWGN	-58.00
		GSM	-58.00
	Upper 700MHz	AWGN	-55.00
		GSM	-55.00
	Cellular	AWGN	-43.00
		GSM	-43.00
	AWS-1	AWGN	-55.00
		GSM	-55.00
	PCS	AWGN	-55.00
		GSM	-55.00



**Maximum Output Power:**

**Uplink:**

Operation Band	Signal Type	Pre AGC Input (dBm)	Maximum Conducted Output Power (dBm)	Conducted Output Power Limit (dBm)	Antenna Gain (dBi)	Cable Loss (dB)	Maximum EIRP (dBm)	EIRP Limit (dBm)
Lower 700MHz	AWGN	-37.40	20.02	≥17	6.6	1.60	25.02	≤30
	GSM	-37.30	20.32	≥17	6.6	1.60	25.32	≤30
Upper 700MHz	AWGN	-34.30	20.99	≥17	6.7	1.70	25.99	≤30
	GSM	-34.30	20.57	≥17	6.7	1.70	25.57	≤30
Cellular	AWGN	-34.40	21.21	≥17	7.1	1.70	26.61	≤30
	GSM	-34.20	19.80	≥17	7.1	1.70	25.20	≤30
AWS-1	AWGN	-39.30	21.47	≥17	7.9	3.30	26.07	≤30
	GSM	-39.20	21.10	≥17	7.9	3.30	25.70	≤30
PCS	AWGN	-38.30	22.07	≥17	8	2.60	27.47	≤30
	GSM	-38.30	22.46	≥17	8	2.60	27.86	≤30

Note: According to the antenna kitting provided by manufacturer, the worst combine of the antenna gain and cable loss was used to calculation the EIRP result.

**Downlink:**

Operation Band	Signal Type	Pre AGC Input (dBm)	Maximum Conducted Output Power (dBm)	Conducted Output Power Limit (dBm)	Antenna Gain (dBi)	Cable Loss (dB)	Maximum EIRP (dBm)	EIRP Limit (dBm)
Lower 700MHz	AWGN	-58.40	2.83	≤17	5.57	0.00	8.40	≤17
	GSM	-58.40	0.78	≤17	5.57	0.00	6.35	≤17
Upper 700MHz	AWGN	-55.20	0.55	≤17	5.79	0.00	6.34	≤17
	GSM	-55.30	-3.36	≤17	5.79	0.00	2.43	≤17
Cellular	AWGN	-43.10	7.36	≤17	5.91	0.00	13.27	≤17
	GSM	-43.10	8.67	≤17	5.91	0.00	14.58	≤17
AWS-1	AWGN	-55.40	7.40	≤17	7.61	0.00	15.01	≤17
	GSM	-55.20	8.58	≤17	7.61	0.00	16.19	≤17
PCS	AWGN	-55.30	6.91	≤17	6.91	0.00	13.82	≤17
	GSM	-55.30	8.05	≤17	6.91	0.00	14.96	≤17

Note:

According to the antenna kitting provided by manufacturer, the worst combine of the antenna gain and cable loss was used to calculation the EIRP result.

Indoor antenna A0801SF connects the booster direct, and A0502SF is Integrated antenna in model SF006B, not use the indoor cable.

**Maximum Input Level:**

Mode	Operation Band	Signal type	Maximum Input level (dBm)	Limit (dBm)	Conducted Output level (dBm)	Limit (dBm)	Antenna Gain (dBi)	Cable loss dB	EIRP (dBm)	Limit (dBm)				
Uplink	Lower 700MHz	AWGN	-27.00	<0	20.63	>17	6.6	1.60	25.63	17~30				
		GSM	-27.00		19.82		6.6	1.60	24.82					
	Upper 700MHz	AWGN	-24.00		21.39		6.7	1.70	26.39					
		GSM	-24.00		20.22		6.7	1.70	25.22					
	Cellular	AWGN	-24.00		21.42		7.1	1.70	26.82					
		GSM	-24.00		19.71		7.1	1.70	25.11					
	AWS-1	AWGN	-29.00		21.58		7.9	3.30	26.18					
		GSM	-29.00		20.93		7.9	3.30	25.53					
	PCS	AWGN	-28.00		22.31		8	2.60	27.71					
		GSM	-28.00		22.55		8	2.60	27.95					
	Downlink	Lower 700MHz	AWGN		-48.00		-20	2.84	/		5.57	0.00	8.41	17
			GSM		-48.00			0.01			5.57	0.00	5.58	
Upper 700MHz		AWGN	-45.00	-0.16	5.79	0.00		5.63						
		GSM	-45.00	-3.39	5.79	0.00		2.40						
Cellular		AWGN	-33.00	7.34	5.91	0.00		13.25						
		GSM	-33.00	8.50	5.91	0.00		14.41						
AWS-1		AWGN	-45.00	7.00	7.61	0.00		14.61						
		GSM	-45.00	8.22	7.61	0.00		15.83						
PCS		AWGN	-45.00	6.45	6.91	0.00		13.36						
		GSM	-45.00	7.86	6.91	0.00		14.77						

Note: the Maximum uplink Input level limit for Fixed using inside antenna was used.

## 4.3 Maximum Booster Gain Computation

### 4.3.1 Applicable Standard

According to § 20.21(e)(8)(i)(C)(2) *Booster Gain Limits* (maximum gain); § 20.21(e)(8)(i)(B) *Bidirectional Capability* (equivalent uplink and downlink gain); §20.21(e)(4) *Self-monitoring*.

This subclause provides guidance for the calculation of the maximum gain, based on the results obtained from the 7.1 and 7.2 measurements. The NPS limits on maximum gain for fixed and mobile wideband consumer signal boosters are provided in Section 20.21(e)(8)(i)(C)(2). Additionally, Section 20.21(e)(8)(i)(B) requires that wideband consumer signal boosters be able to provide equivalent uplink and downlink gain, i.e., within 9 dB.

### 4.3.2 Test Procedure

KDB 935210 D03 Signal Booster Measurements v04r04 Clause 7.3

- a) Calculate the maximum gain of the booster as follows to demonstrate compliance to the applicable gain limits as specified.
- b) For both the uplink and downlink in each supported frequency band, use each of the  $P_{OUT}$  and  $P_{IN}$  result pairs for all signal types used in 7.2 in the following equation to obtain the maximum gain, G:  
$$G \text{ (dB)} = P_{OUT}(\text{dBm}) - P_{IN}(\text{dBm}).$$
- c) Record the maximum gain of the uplink and downlink paths for each supported frequency band, and verify that the each gain value complies with the applicable limit.
- d) Provide tabulated results in the test report.

**4.3.3 Test Result**

Serial Number:	2G05-5	Test Date:	2024/2/21~2024/2/23
Test Site:	RF	Test Mode:	Transmitting
Tester:	Stu Song	Test Result:	Pass

**Environmental Conditions:**

Temperature: (°C)	24.2~26.3	Relative Humidity: (%)	42~64	ATM Pressure: (kPa)	100.7~101.5
----------------------	-----------	---------------------------	-------	------------------------	-------------

**Test Equipment List and Details:**

Manufacturer	Description	Model	Serial Number	Calibration Date	Calibration Due Date
R&S	Spectrum Analyzer	FSU 26	200160/026	2023/10/18	2024/10/17
yzjingcheng	Coaxial Cable	KTRFBU-141-50	41010012	2023/9/1	2024/8/31
yzjingcheng	Coaxial Cable	KTRFBU-141-50	41010013	2023/9/1	2024/8/31
Eastsheep	Coaxial Attenuator	5W-N-JK-6G-10dB	F-08-EM502	2023/9/10	2024/9/9
Agilent	MXG Vector Signal Generator	N5182B	MY51350142	2023/9/1	2024/8/31

*\* Statement of Traceability: Bay Area Compliance Laboratories Corp. (Dongguan) attests that all calibrations have been performed, traceable to National Primary Standards and International System of Units (SI).*

**Test Data:  
Maximum Gain:**

Mode	Operation Band	Signal Type	Pre AGC Input (dBm)	Maximum Conducted Output Power (dBm)	Gain (dB)	Gain Limit (dB)	
Uplink	Lower 700MHz	AWGN	-37.40	20.02	57.42	≤63.49	
		GSM	-37.30	20.32	57.62	≤63.49	
	Upper 700MHz	AWGN	-34.30	20.99	55.29	≤64.36	
		GSM	-34.30	20.57	54.87	≤64.36	
	Cellular	AWGN	-34.40	21.21	55.61	≤64.95	
		GSM	-34.20	19.80	54	≤64.95	
	AWS-1	AWGN	-39.30	21.47	60.77	≤71.27	
		GSM	-39.20	21.10	60.3	≤71.27	
	PCS	AWGN	-38.30	22.07	60.37	≤71.99	
		GSM	-38.30	22.46	60.76	≤71.99	
	Downlink	Lower 700MHz	AWGN	-58.40	2.83	61.23	≤63.49
			GSM	-58.40	0.78	59.18	≤63.49
Upper 700MHz		AWGN	-55.20	0.55	55.75	≤64.36	
		GSM	-55.30	-3.36	51.94	≤64.36	
Cellular		AWGN	-43.10	7.36	50.46	≤64.95	
		GSM	-43.10	8.67	51.77	≤64.95	
AWS-1		AWGN	-55.40	7.40	62.8	≤71.27	
		GSM	-55.20	8.58	63.78	≤71.27	
PCS		AWGN	-55.30	6.91	62.21	≤71.99	
		GSM	-55.30	8.05	63.35	≤71.99	

Note:

Fixed Booster maximum gain shall not exceed  $6.5 \text{ dB} + 20 \text{ Log}_{10}(\text{Frequency})$ , Where, Frequency is the uplink mid-band frequency of the supported spectrum bands in MHz.

**Equivalent Uplink and Downlink Gain:**

Operation Band	Signal Type	Uplink Gain (dB)	Downlink Gain (dB)	Gain Computation (dB)	Gain Computation Limit (dB)
Lower 700MHz	AWGN	57.42	61.23	3.81	±9
	GSM	57.62	59.18	1.56	±9
Upper 700MHz	AWGN	55.29	55.75	0.46	±9
	GSM	54.87	51.94	-2.93	±9
Cellular	AWGN	55.61	50.46	-5.15	±9
	GSM	54	51.77	-2.23	±9
AWS-1	AWGN	60.77	62.8	2.03	±9
	GSM	60.3	63.78	3.48	±9
PCS	AWGN	60.37	62.21	1.84	±9
	GSM	60.76	63.35	2.59	±9

## 4.4 Intermodulation Product

### 4.4.1 Applicable Standard

According to § 20.21(e)(8)(i)(F) *Intermodulation Limits*.

### 4.4.2 Test Procedure

KDB 935210 D03 Signal Booster Measurements v04r04 Clause 7.4

The following procedures shall be used to demonstrate compliance to the intermodulation limit specified in Section 20.21(e)(8)(i)(F) for wideband consumer signal boosters.

- a) Connect the signal booster to the test equipment as shown in **Figure 2**. Begin with the uplink output (donor) port connected to the spectrum analyzer.
  - b) Set the spectrum analyzer RBW = 3 kHz.
  - c) Set the VBW  $\geq 3 \times$  RBW.
  - d) Select the rms detector.
  - e) Set the spectrum analyzer center frequency to the center of the supported operational band under test.
  - f) Set the span to 5 MHz. Affirm that the number of measurement points per sweep  $\geq (2 \times \text{span})/\text{RBW}$ .
  - g) Configure the two signal generators for CW operation with generator #1 tuned 300 kHz below the operational band center frequency and generator #2 tuned 300 kHz above the operational band center frequency. If the maximum output power is not at the operational-band (booster pass band) center frequency, configure the test signal pair around the frequency with maximum output power as determined per 7.2.
  - h) Set the signal generator amplitudes so that the power from each into the EUT is equivalent, then turn on the RF output.
  - i) Simultaneously increase each signal generators' amplitude equally until just before the EUT begins AGC, then affirm that all intermodulation-product emissions (if any occur) are below the specified limit of -19 dBm.
  - j) Use the trace averaging function of the spectrum analyzer, and wait for the trace to stabilize. Place a marker at the highest amplitude intermodulation-product emission.
  - k) Record the maximum intermodulation product amplitude level that is observed.
  - l) Capture the spectrum analyzer trace for inclusion in the test report.
  - m) Repeat 7.4e) to 7.4l) for all uplink and downlink operational bands.
- NOTE—If using a single signal generator with dual outputs, affirm that intermodulation products are not the result of the generator.*
- n) Increase the signal generator amplitude in 2 dB steps to 10 dB above the AGC threshold determined in 7.4i), but not exceeding the maximum input level of 5.5, to affirm that the EUT maintains compliance with the intermodulation limit. The test report shall include either a statement describing that the device complies at 10 dB above AGC or at the 5.5 power levels, or a table showing compliance at the additional input power(s) required.

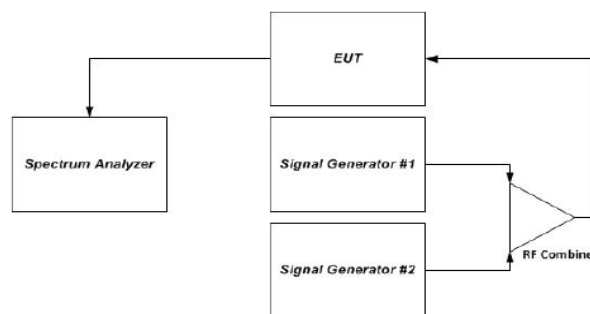

Figure 2 – Intermodulation product instrumentation test setup

**4.4.3 Test Result**

Serial Number:	2G05-5	Test Date:	2024/2/21~2024/2/23
Test Site:	RF	Test Mode:	Transmitting
Tester:	Stu Song	Test Result:	Pass

**Environmental Conditions:**

Temperature: (°C)	24.2~26.3	Relative Humidity: (%)	42~64	ATM Pressure: (kPa)	100.7~101.5
----------------------	-----------	---------------------------	-------	------------------------	-------------

**Test Equipment List and Details:**

Manufacturer	Description	Model	Serial Number	Calibration Date	Calibration Due Date
R&S	Spectrum Analyzer	FSU 26	200160/026	2023/10/18	2024/10/17
yzjingcheng	Coaxial Cable	KTRFBU-141-50	41010012	2023/9/1	2024/8/31
yzjingcheng	Coaxial Cable	KTRFBU-141-50	41010013	2023/9/1	2024/8/31
Eastsheep	Coaxial Attenuator	5W-N-JK-6G-10dB	F-08-EM502	2023/9/10	2024/9/9
Agilent	MXG Vector Signal Generator	N5182B	MY51350142	2023/9/1	2024/8/31

*\* Statement of Traceability: Bay Area Compliance Laboratories Corp. (Dongguan) attests that all calibrations have been performed, traceable to National Primary Standards and International System of Units (SI).*

**Test Data:**

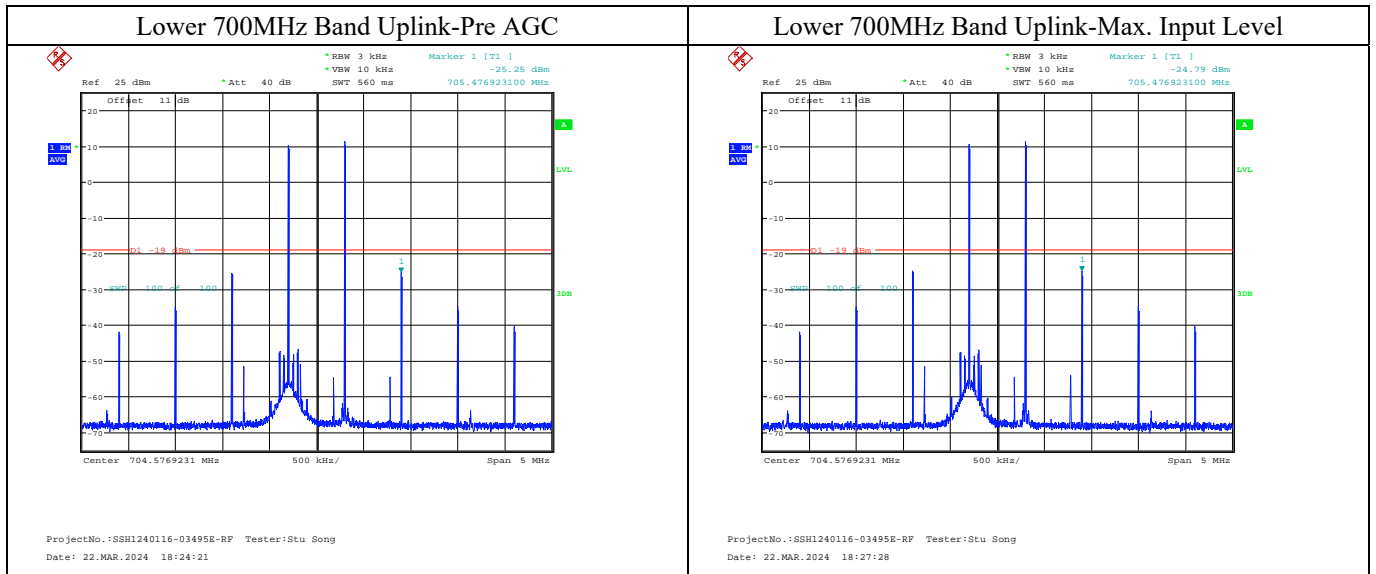

Upper 700MHz Band Uplink-Pre AGC

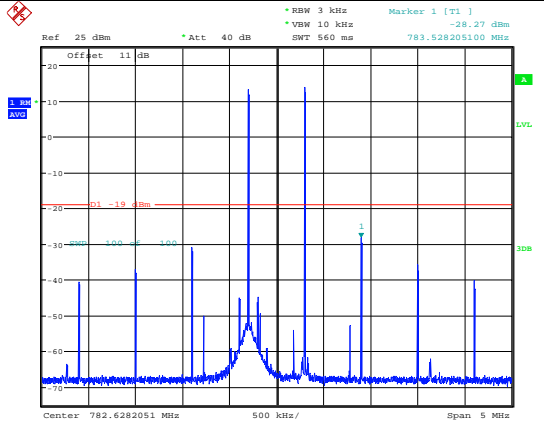

ProjectNo.:SSH1240116-03495E-RF Tester:Stu Song  
Date: 22.MAR.2024 19:01:56

Upper 700MHz Band Uplink-Max. Input Level

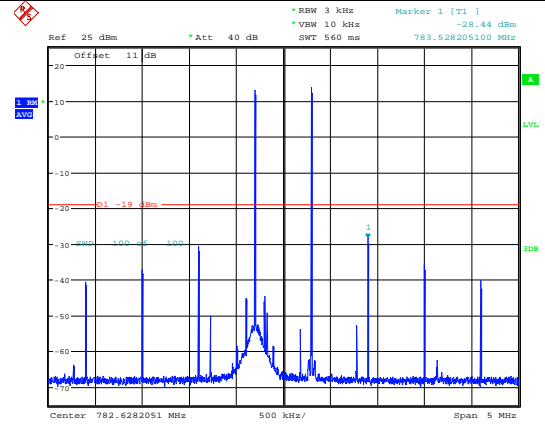

ProjectNo.:SSH1240116-03495E-RF Tester:Stu Song  
Date: 22.MAR.2024 19:04:17

Cellular Band Uplink-Pre AGC

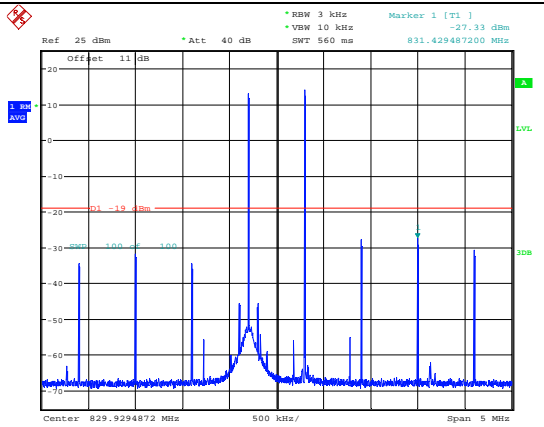

ProjectNo.:SSH1240116-03495E-RF Tester:Stu Song  
Date: 22.MAR.2024 19:08:57

Cellular Band Uplink-Max. Input Level

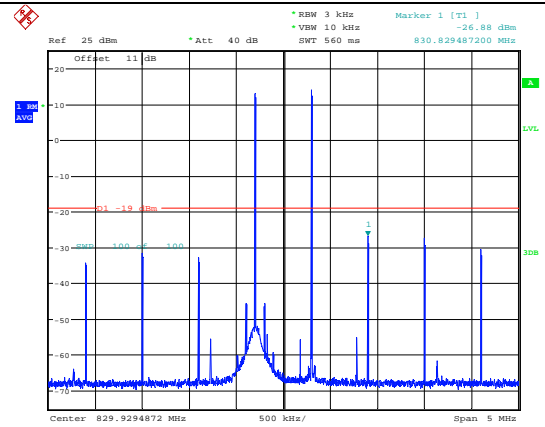

ProjectNo.:SSH1240116-03495E-RF Tester:Stu Song  
Date: 22.MAR.2024 19:12:29

AWS-1 Band Uplink-Pre AGC

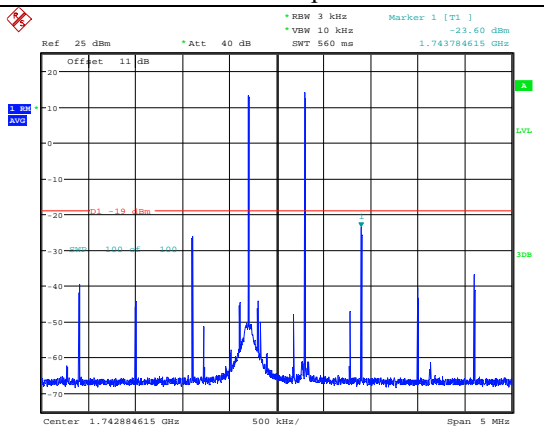

ProjectNo.:SSH1240116-03495E-RF Tester:Stu Song  
Date: 22.MAR.2024 19:18:21

AWS-1 Band Uplink-Max. Input Level

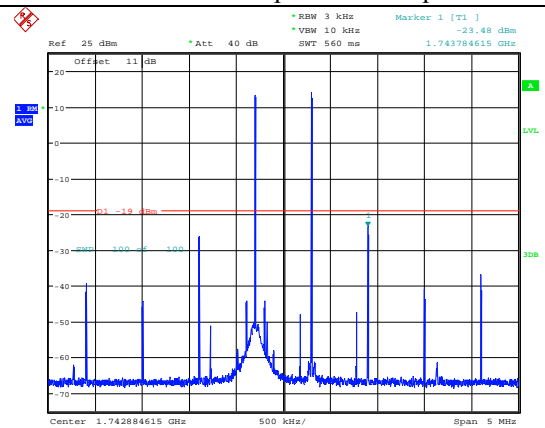

ProjectNo.:SSH1240116-03495E-RF Tester:Stu Song  
Date: 22.MAR.2024 19:20:16



PCS Band Uplink-Pre AGC

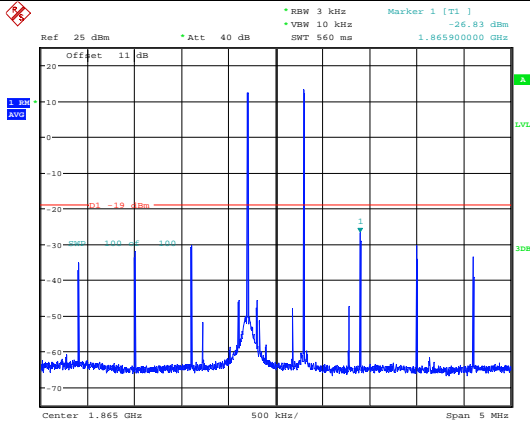

ProjectNo.:SSH1240116-03495E-RF Tester:Stu Song  
Date: 22.MAR.2024 19:24:49

PCS Band Uplink-Max. Input Level

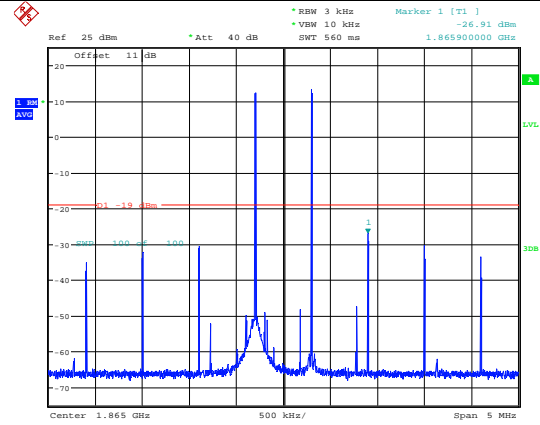

ProjectNo.:SSH1240116-03495E-RF Tester:Stu Song  
Date: 22.MAR.2024 19:30:21

Lower 700MHz Band Downlink-Pre AGC

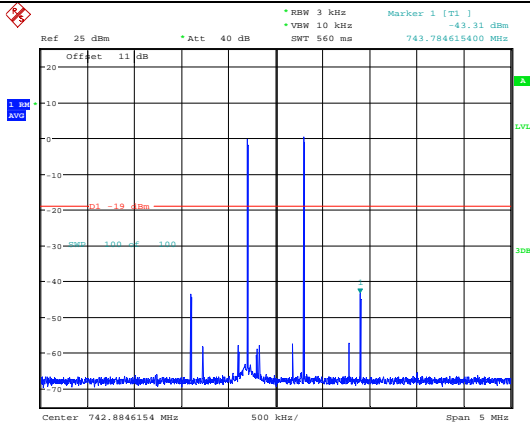

ProjectNo.:SSH1240116-03495E-RF Tester:Stu Song  
Date: 22.MAR.2024 20:16:00

Lower 700MHz Band Downlink -Max. Input Level

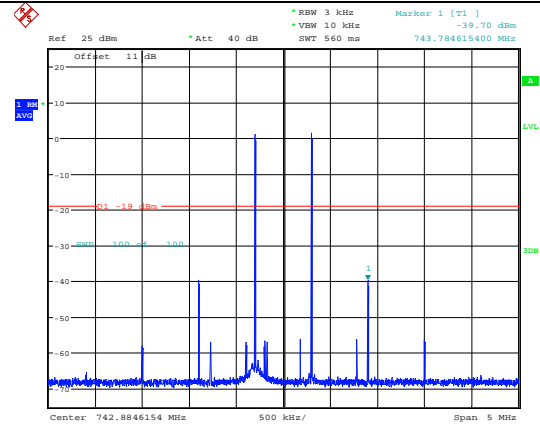

ProjectNo.:SSH1240116-03495E-RF Tester:Stu Song  
Date: 22.MAR.2024 20:18:19

Upper 700MHz Band Downlink -Pre AGC

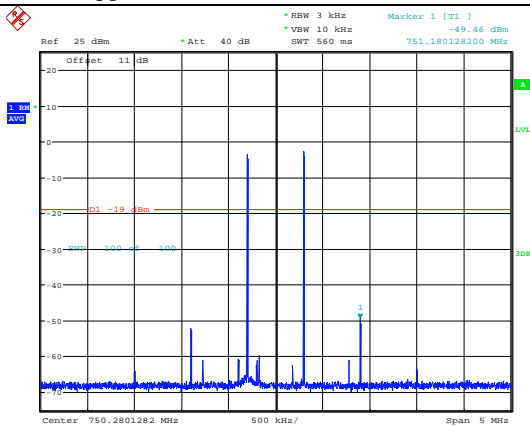

ProjectNo.:SSH1240116-03495E-RF Tester:Stu Song  
Date: 22.MAR.2024 20:22:29

Upper 700MHz Band Downlink -Max. Input Level

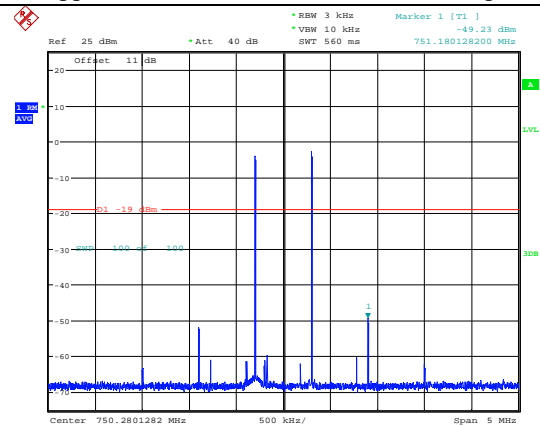

ProjectNo.:SSH1240116-03495E-RF Tester:Stu Song  
Date: 22.MAR.2024 20:24:35

Cellular Band Downlink -Pre AGC

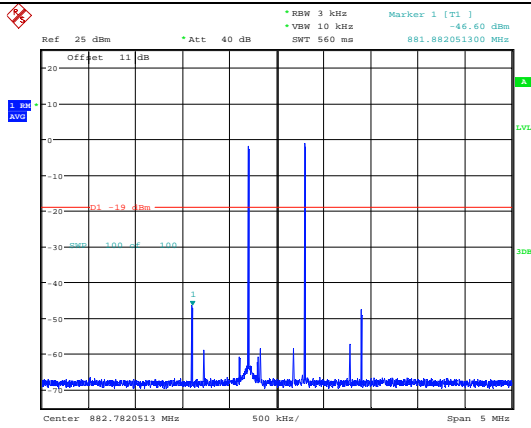

ProjectNo.:SSH1240116-03495E-RF Tester:Stu Song  
Date: 22.MAR.2024 20:29:20

Cellular Band Downlink -Max. Input Level

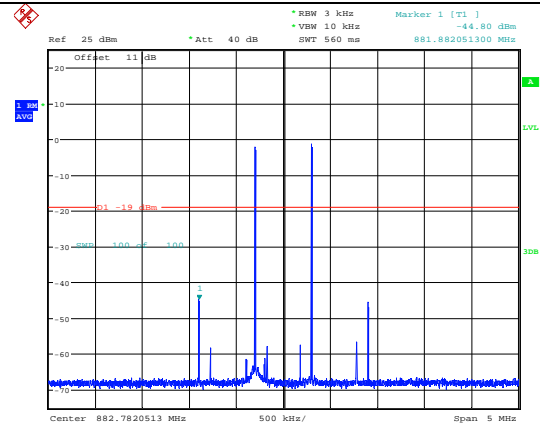

ProjectNo.:SSH1240116-03495E-RF Tester:Stu Song  
Date: 22.MAR.2024 20:35:35

AWS-1 Band Downlink -Pre AGC

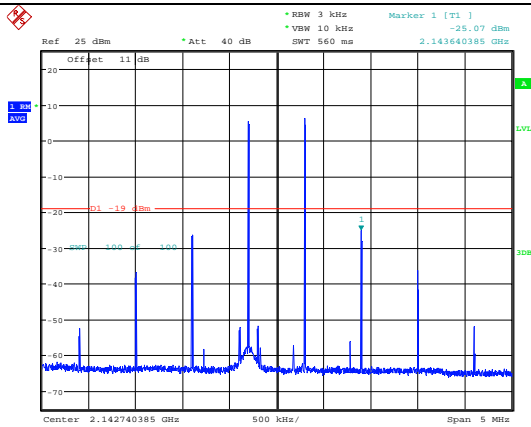

ProjectNo.:SSH1240116-03495E-RF Tester:Stu Song  
Date: 22.MAR.2024 20:39:32

AWS-1 Band Downlink -Max. Input Level

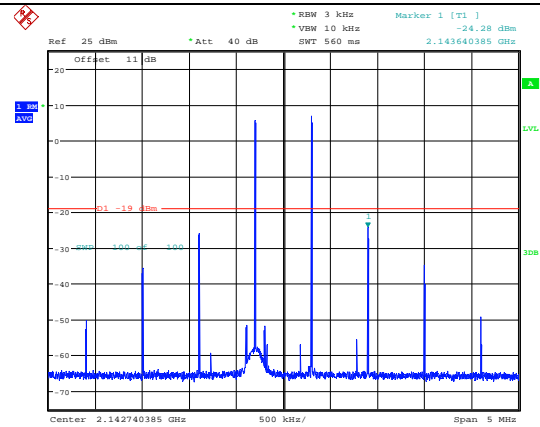

ProjectNo.:SSH1240116-03495E-RF Tester:Stu Song  
Date: 22.MAR.2024 20:41:06

PCS Band Downlink -Pre AGC

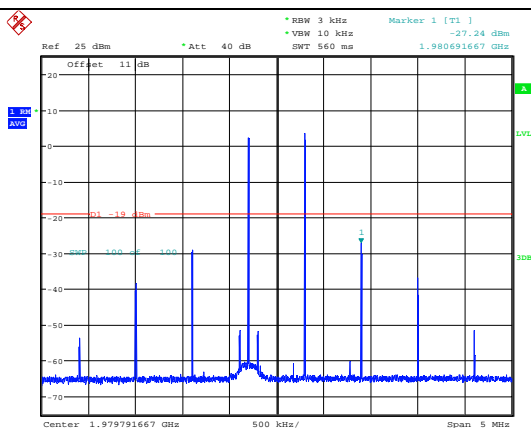

ProjectNo.:SSH1240116-03495E-RF Tester:Stu Song  
Date: 22.MAR.2024 20:47:06

PCS Band Downlink -Max. Input Level

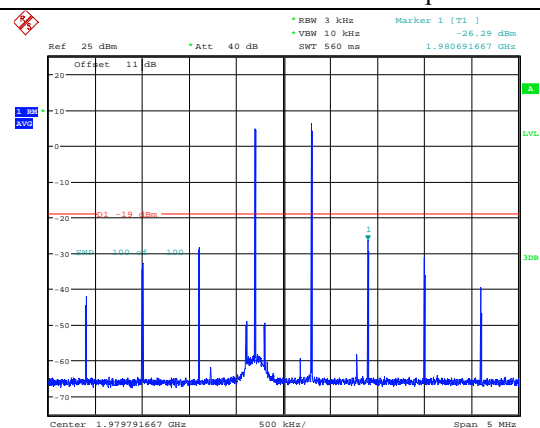

ProjectNo.:SSH1240116-03495E-RF Tester:Stu Song  
Date: 22.MAR.2024 20:48:41

## 4.5 Out Of Band Emissions

### 4.5.1 Applicable Standard

According to § 20.21(e)(8)(i)(E) *Out of Band Emission Limits*.

### 4.5.2 Test Procedure

KDB 935210 D03 Signal Booster Measurements v04r04 Clause 7.5

This measurement is intended to demonstrate compliance to the limit specified in Section 20.21(e)(8)(i)(E). The mobile-station emission limit is listed in Appendix A for each applicable operating band and rule part.

- a) Connect the EUT to the test equipment as shown in **Figure 1**. Begin with the uplink output (donor) port connected to the spectrum analyzer.
- b) Configure the signal generator for the appropriate operation for all uplink and downlink bands:
  - 1) GSM: 0.2 MHz from upper and lower band edges.
  - 2) LTE (5 MHz): 2.5 MHz from upper and lower band edges.
  - 3) CDMA: 1.25 MHz from upper and lower band edges, except for cellular band as follows (only the upper and lower frequencies need to be tested):  
824.88 MHz, 845.73 MHz, 836.52 MHz, 848.10 MHz,  
869.88 MHz, 890.73 MHz, 881.52 MHz, 893.10 MHz.

*NOTE 1—Alternative test modulation types:*

- CDMA (alternative 1.25 MHz AWGN)
- LTE 5 MHz (alternative W-CDMA or 4.1 MHz AWGN)

*NOTE 2—For LTE, the signal generator should use the uplink and downlink signal types for these modulations in uplink and downlink tests, respectively. LTE shall use 5 MHz signal, 25 resource blocks transmitting.*

*NOTE 3—When using an AWGN test signal, the bandwidth shall be the measured 99% OBW.*

- c) Set the signal generator amplitude to the maximum power level prior to AGC similar to 7.2.2e) to 7.2.2f) of the power measurement procedures for the appropriate modulations.
- d) Set RBW = measurement bandwidth specified in the applicable rule section for the supported frequency band (see Appendix A for cross-reference to applicable rule section).

*NOTE 3—Within 300 kHz and 3 MHz away from band edge, if smaller RBW is used (i.e., RBW < 100 kHz or 1 MHz, for above and below 1 GHz, respectively), per Parts 24 and 27 the smaller RBW is applicable only for frequencies within 100 kHz or 1 MHz (for above and below 1 GHz, respectively) away from the band edge.*
- e) Set VBW = 3\* RBW.
- f) Select the power averaging (rms) detector.
- g) Sweep time = auto-couple.
- h) Set the analyzer start frequency to the upper band/block edge frequency and the stop frequency to the upper band/block edge frequency plus: 300 kHz (when operational frequency is < 1 GHz), or 3 MHz (when operational frequency is ≥ 1 GHz).
- i) Trace average at least 100 traces in power averaging (i.e., rms) mode.
- j) Use peak marker function to find the maximum power level.
- k) Capture the spectrum analyzer trace of the power level for inclusion in the test report.
- l) Increase the signal generator amplitude in 2 dB steps until the maximum input level per 5.5 is reached. Affirm that the EUT maintains compliance with the OOB limits. The test report shall

- include either a statement describing that the device complies at 10 dB above AGC or at the 5.5 power levels, or a table showing compliance at the additional input power(s) required.
- m) Reset the analyzer start frequency to the lower band/block edge frequency minus: 300 kHz (when operational frequency is < 1 GHz), or 3 MHz (when operational frequency is  $\geq$  1 GHz), and the stop frequency to the lower band/block edge frequency, then repeat 7.5i) to 7.5l).
- n) Repeat 7.5b) through 7.5m) for each uplink and downlink operational band.

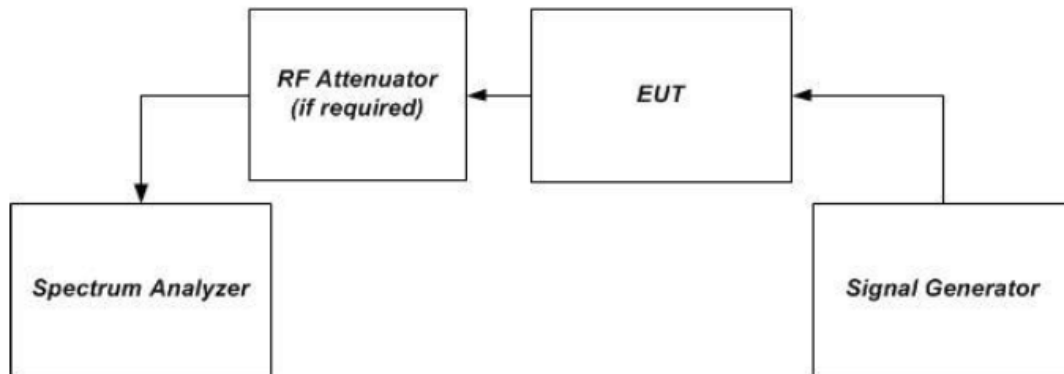

Figure 1 – Band verification test instrumentation setup

**4.5.3 Test Result**

Serial Number:	2G05-5	Test Date:	2024/4/12
Test Site:	RF	Test Mode:	Transmitting
Tester:	Stu Song	Test Result:	Pass

**Environmental Conditions:**

Temperature: (°C)	25.2	Relative Humidity: (%)	52	ATM Pressure: (kPa)	100.7
----------------------	------	---------------------------	----	------------------------	-------

**Test Equipment List and Details:**

Manufacturer	Description	Model	Serial Number	Calibration Date	Calibration Due Date
R&S	Spectrum Analyzer	FSU 26	200160/026	2023/10/18	2024/10/17
yzjingcheng	Coaxial Cable	KTRFBU-141-50	41010012	2023/9/1	2024/8/31
yzjingcheng	Coaxial Cable	KTRFBU-141-50	41010013	2023/9/1	2024/8/31
Eastsheep	Coaxial Attenuator	5W-N-JK-6G-10dB	F-08-EM502	2023/9/10	2024/9/9
Agilent	MXG Vector Signal Generator	N5182B	MY51350142	2023/9/1	2024/8/31

\* Statement of Traceability: Bay Area Compliance Laboratories Corp. (Dongguan) attests that all calibrations have been performed, traceable to National Primary Standards and International System of Units (SI).

**Test Data:**

**Lower 700M Band Uplink**

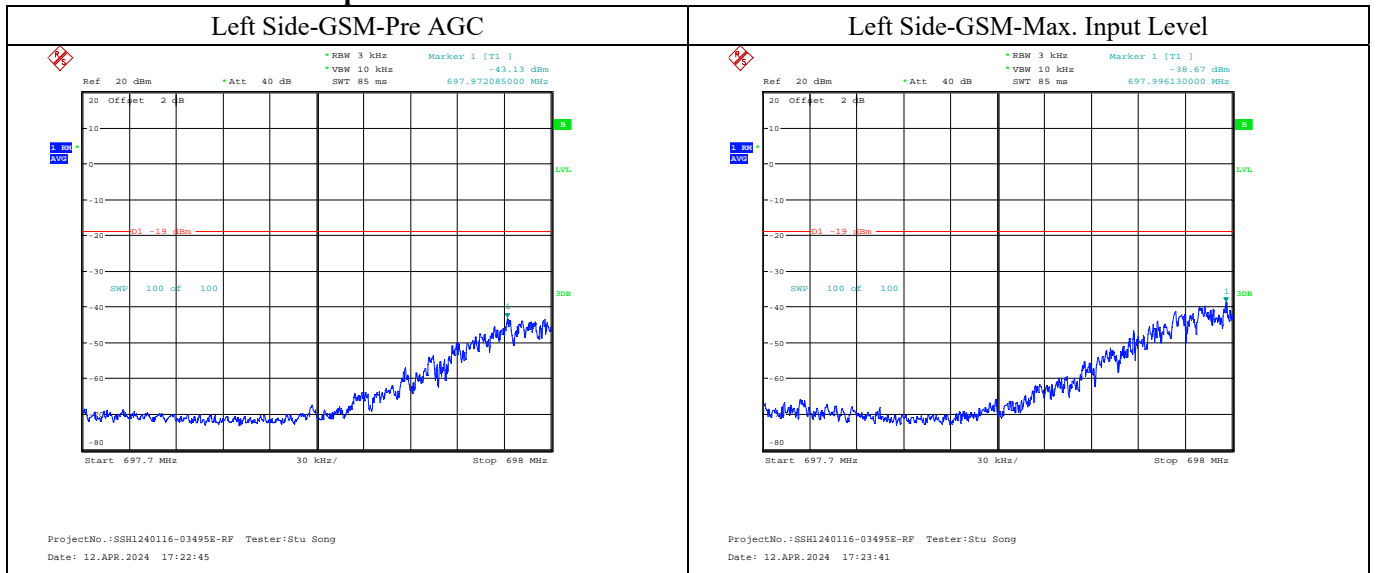

Left Side-CDMA-Pre AGC

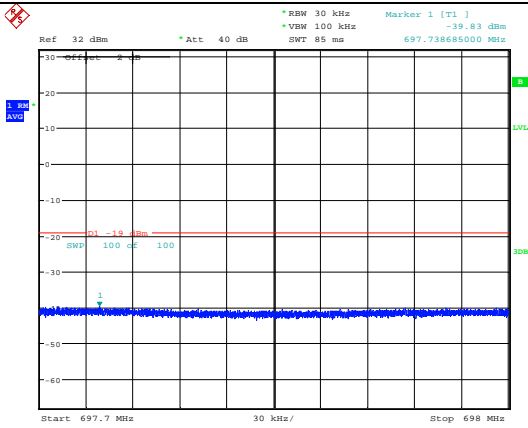

ProjectNo.:SSH1240116-03495E-RF Tester:Stu Song  
 Date: 12.APR.2024 15:19:46

Left Side-CDMA-Max. Input Level

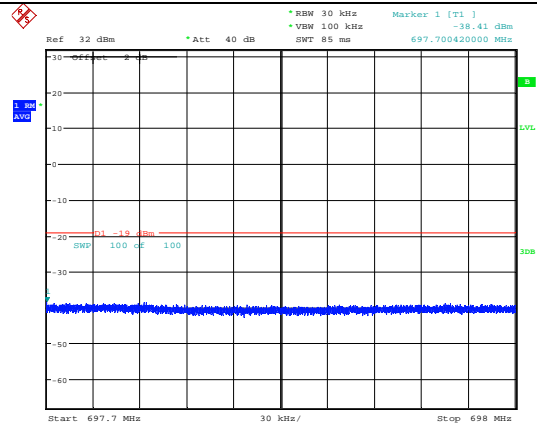

ProjectNo.:SSH1240116-03495E-RF Tester:Stu Song  
 Date: 12.APR.2024 15:20:48

Left Side-WCDMA-Pre AGC

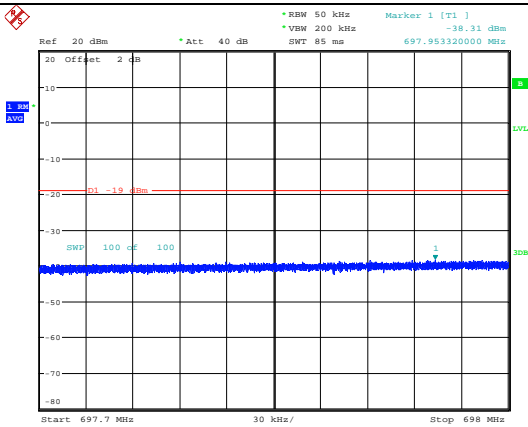

ProjectNo.:SSH1240116-03495E-RF Tester:Stu Song  
 Date: 12.APR.2024 17:58:03

Left Side-WCDMA-Max. Input Level

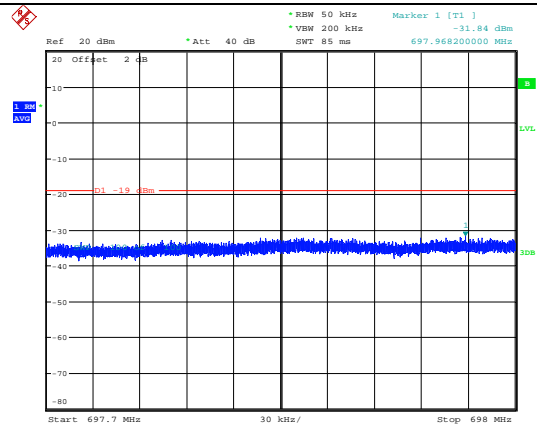

ProjectNo.:SSH1240116-03495E-RF Tester:Stu Song  
 Date: 12.APR.2024 17:58:58

Right Side-GSM-Pre AGC

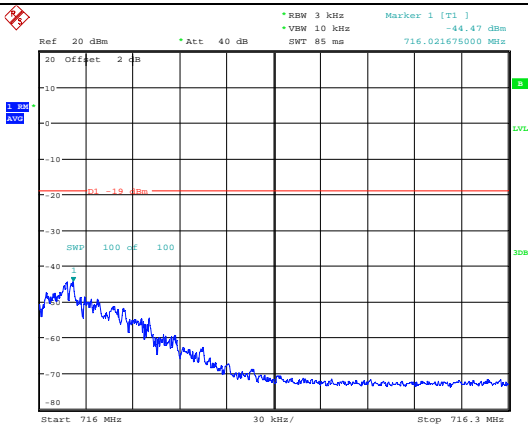

ProjectNo.:SSH1240116-03495E-RF Tester:Stu Song  
 Date: 12.APR.2024 17:25:01

Right Side-GSM-Max. Input Level

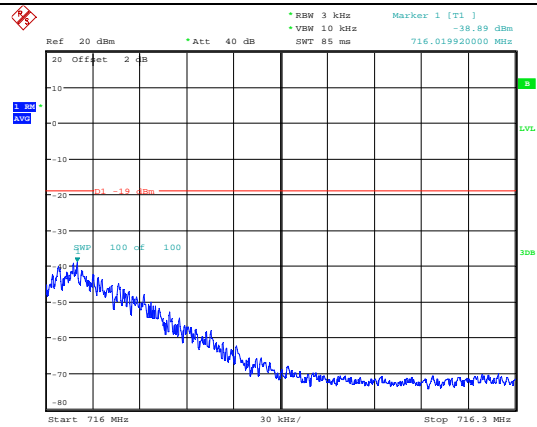

ProjectNo.:SSH1240116-03495E-RF Tester:Stu Song  
 Date: 12.APR.2024 17:25:59

Right Side-CDMA-Pre AGC

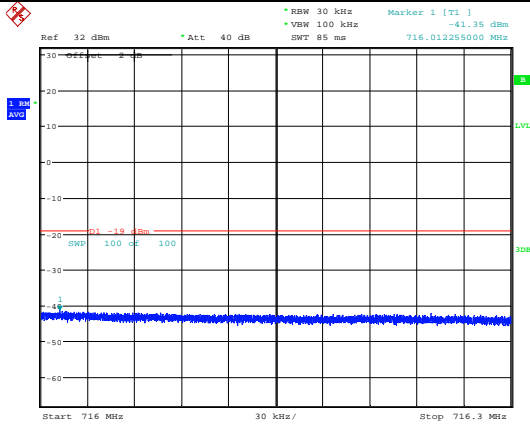

ProjectNo.:SSH1240116-03495E-RF Tester:Stu Song  
Date: 12.APR.2024 15:22:49

Right Side-CDMA-Max. Input Level

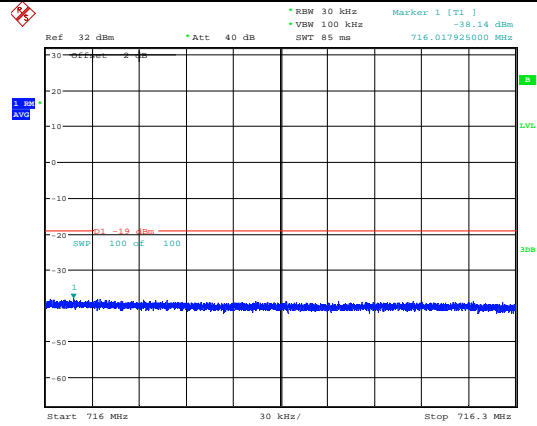

ProjectNo.:SSH1240116-03495E-RF Tester:Stu Song  
Date: 12.APR.2024 15:25:34

Right Side-WCDMA-Pre AGC

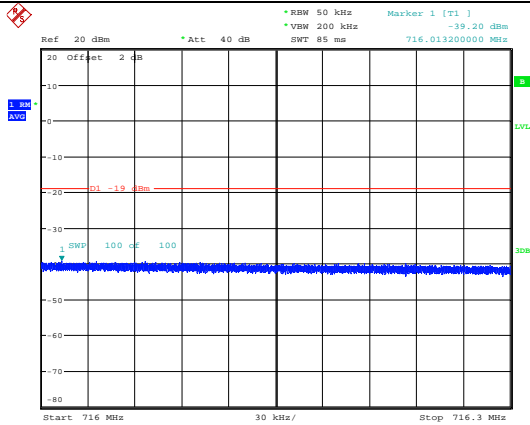

ProjectNo.:SSH1240116-03495E-RF Tester:Stu Song  
Date: 12.APR.2024 18:00:27

Right Side-WCDMA-Max. Input Level

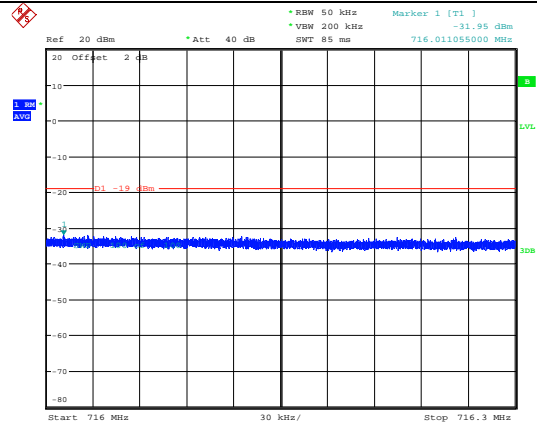

ProjectNo.:SSH1240116-03495E-RF Tester:Stu Song  
Date: 12.APR.2024 18:01:16

Upper 700M Band Uplink

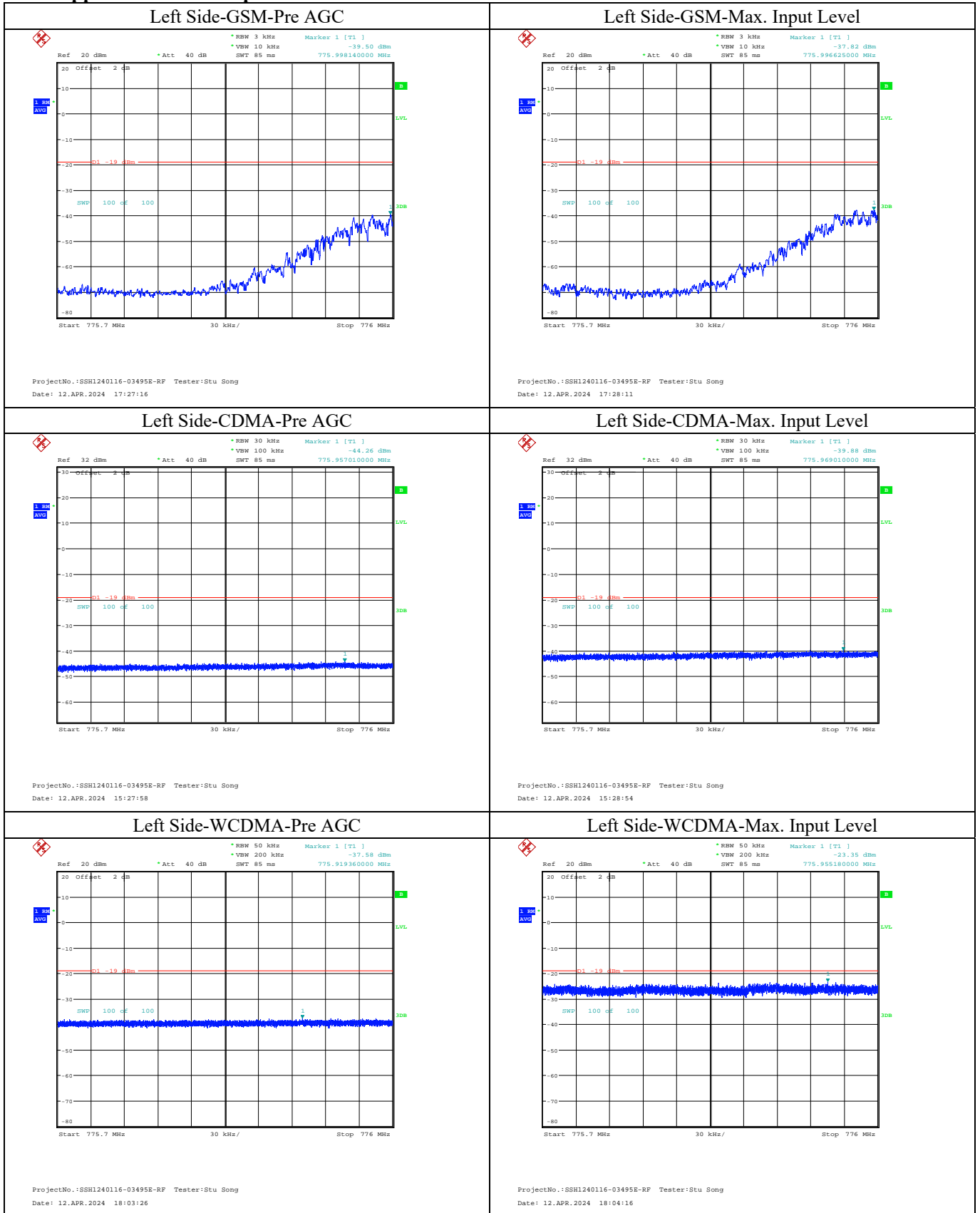



Right Side-GSM-Pre AGC

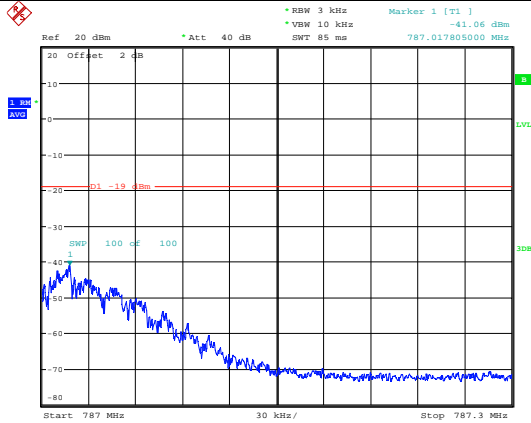

ProjectNo.:SSH1240116-03495E-RF Tester:Stu Song  
Date: 12.APR.2024 17:30:26

Right Side-GSM-Max. Input Level

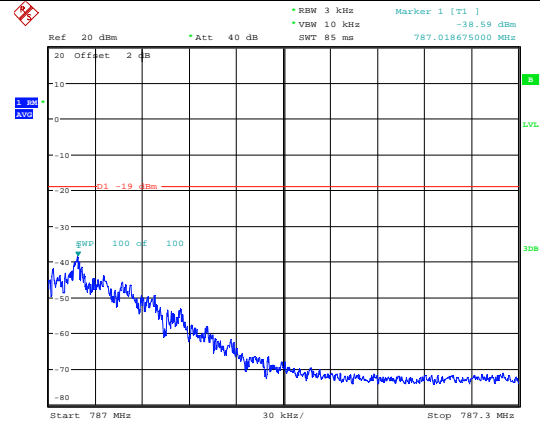

ProjectNo.:SSH1240116-03495E-RF Tester:Stu Song  
Date: 12.APR.2024 17:31:16

Right Side-CDMA-Pre AGC

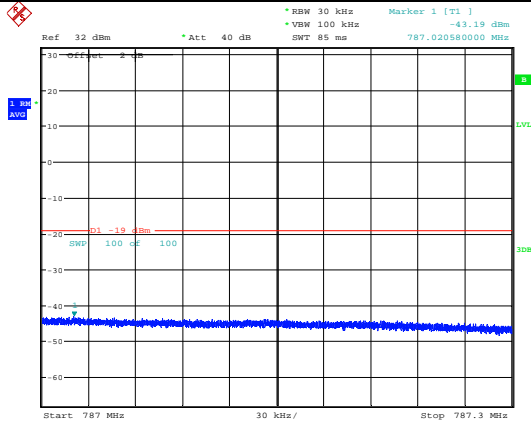

ProjectNo.:SSH1240116-03495E-RF Tester:Stu Song  
Date: 12.APR.2024 15:30:25

Right Side-CDMA-Max. Input Level

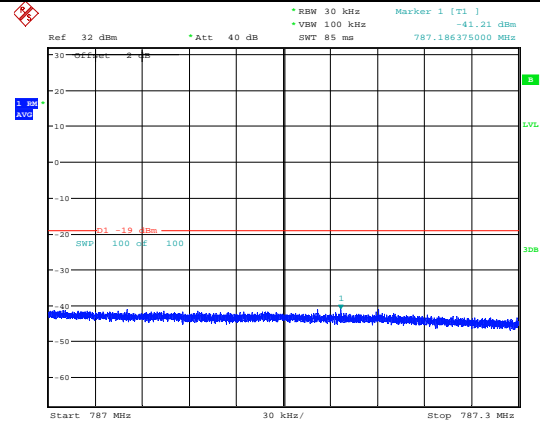

ProjectNo.:SSH1240116-03495E-RF Tester:Stu Song  
Date: 12.APR.2024 15:31:19

Right Side-WCDMA-Pre AGC

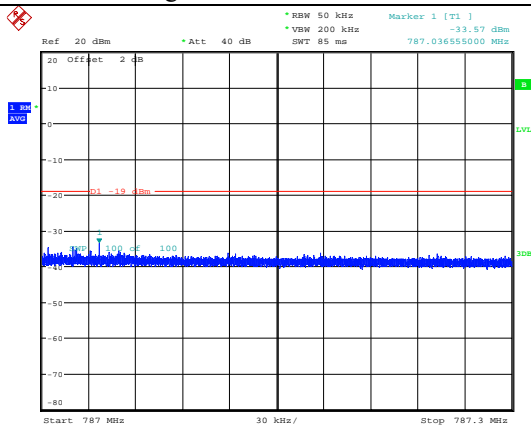

ProjectNo.:SSH1240116-03495E-RF Tester:Stu Song  
Date: 12.APR.2024 18:05:31

Right Side-WCDMA-Max. Input Level

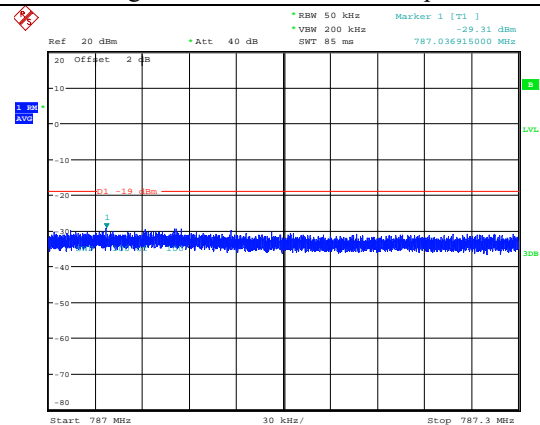

ProjectNo.:SSH1240116-03495E-RF Tester:Stu Song  
Date: 12.APR.2024 18:06:17

**Cellular Band Uplink**

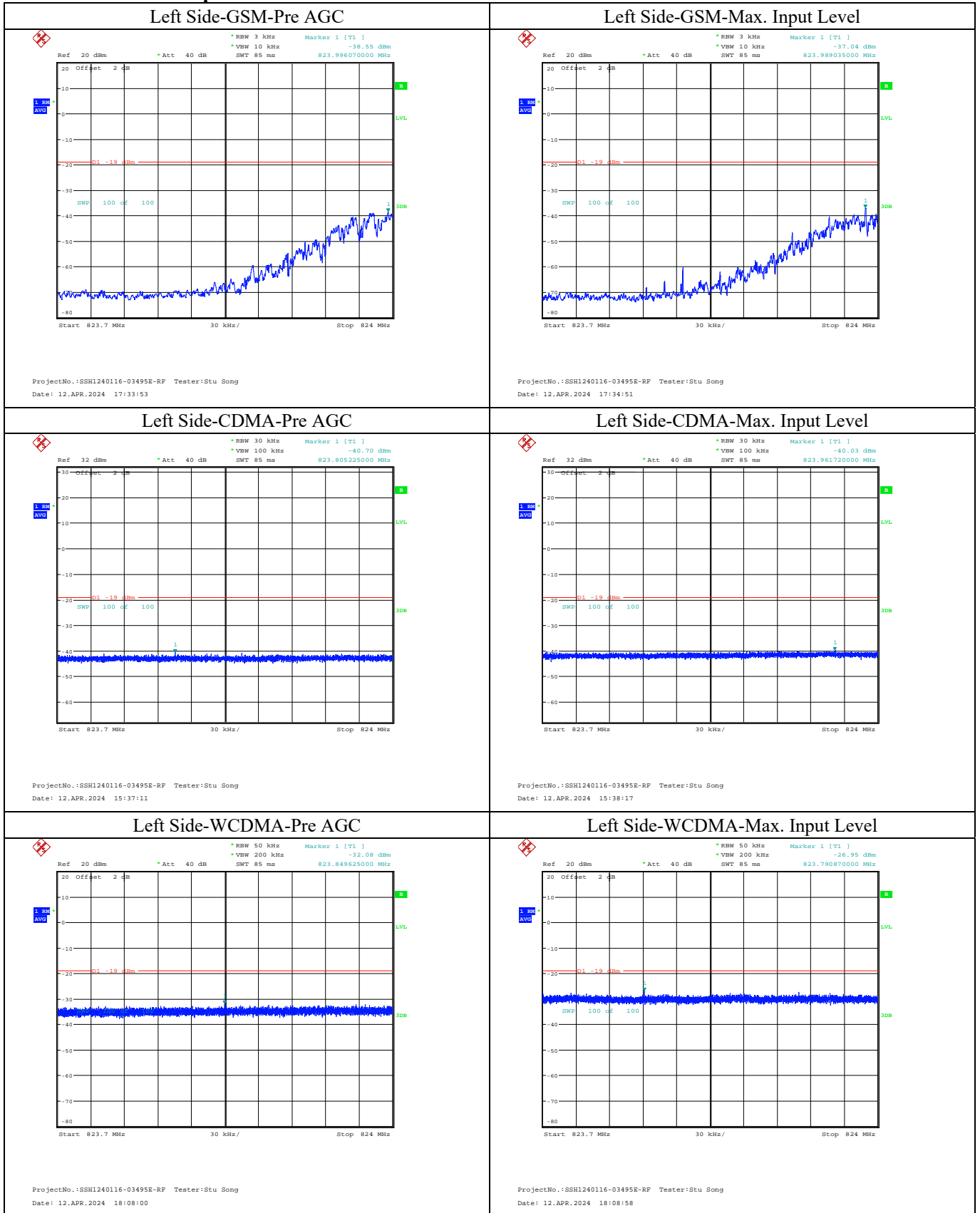

Right Side-GSM-Pre AGC

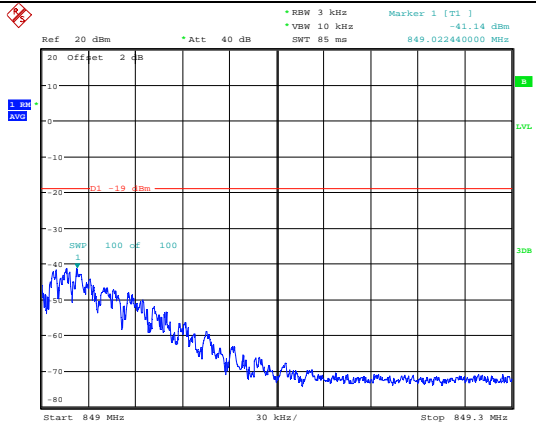

ProjectNo.:SSH1240116-03495E-RF Tester:Stu Song  
Date: 12.APR.2024 17:35:58

Right Side-GSM-Max. Input Level

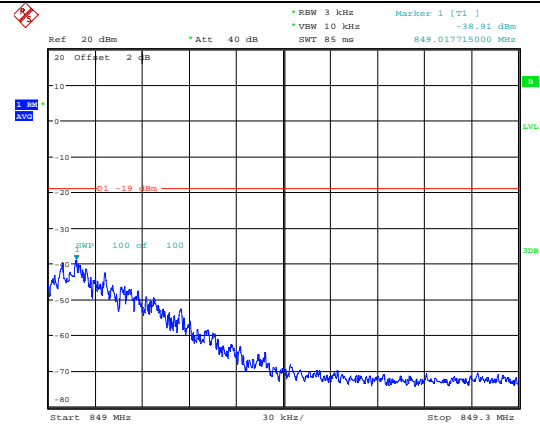

ProjectNo.:SSH1240116-03495E-RF Tester:Stu Song  
Date: 12.APR.2024 17:36:47

Right Side-CDMA-Pre AGC

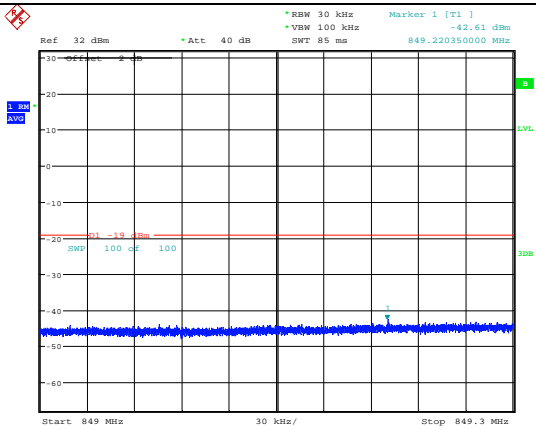

ProjectNo.:SSH1240116-03495E-RF Tester:Stu Song  
Date: 12.APR.2024 15:40:21

Right Side-CDMA-Max. Input Level

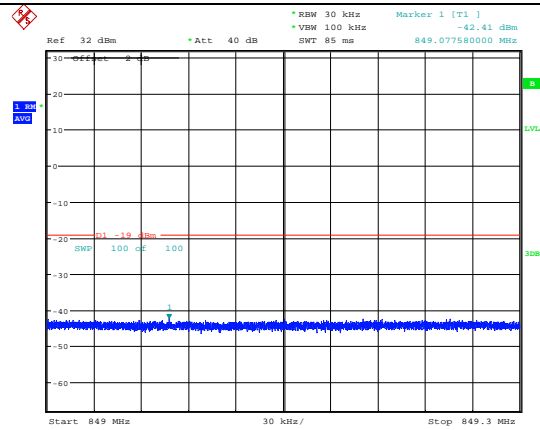

ProjectNo.:SSH1240116-03495E-RF Tester:Stu Song  
Date: 12.APR.2024 15:41:22

Right Side-WCDMA-Pre AGC

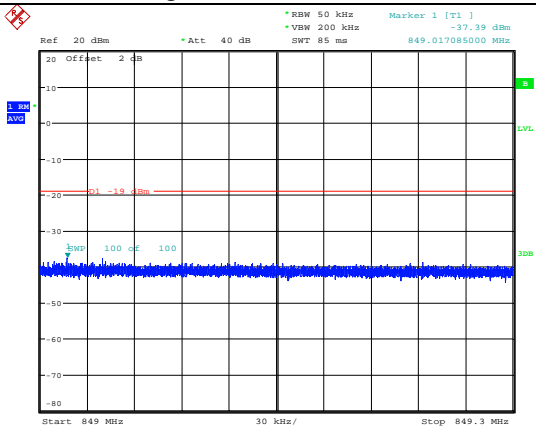

ProjectNo.:SSH1240116-03495E-RF Tester:Stu Song  
Date: 12.APR.2024 18:10:23

Right Side-WCDMA-Max. Input Level

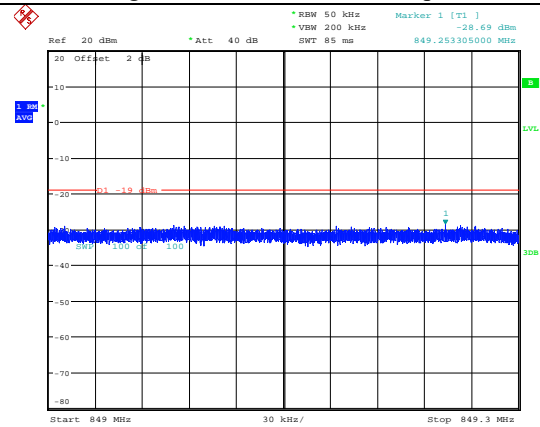

ProjectNo.:SSH1240116-03495E-RF Tester:Stu Song  
Date: 12.APR.2024 18:11:10

**AWS-1 Band Uplink**

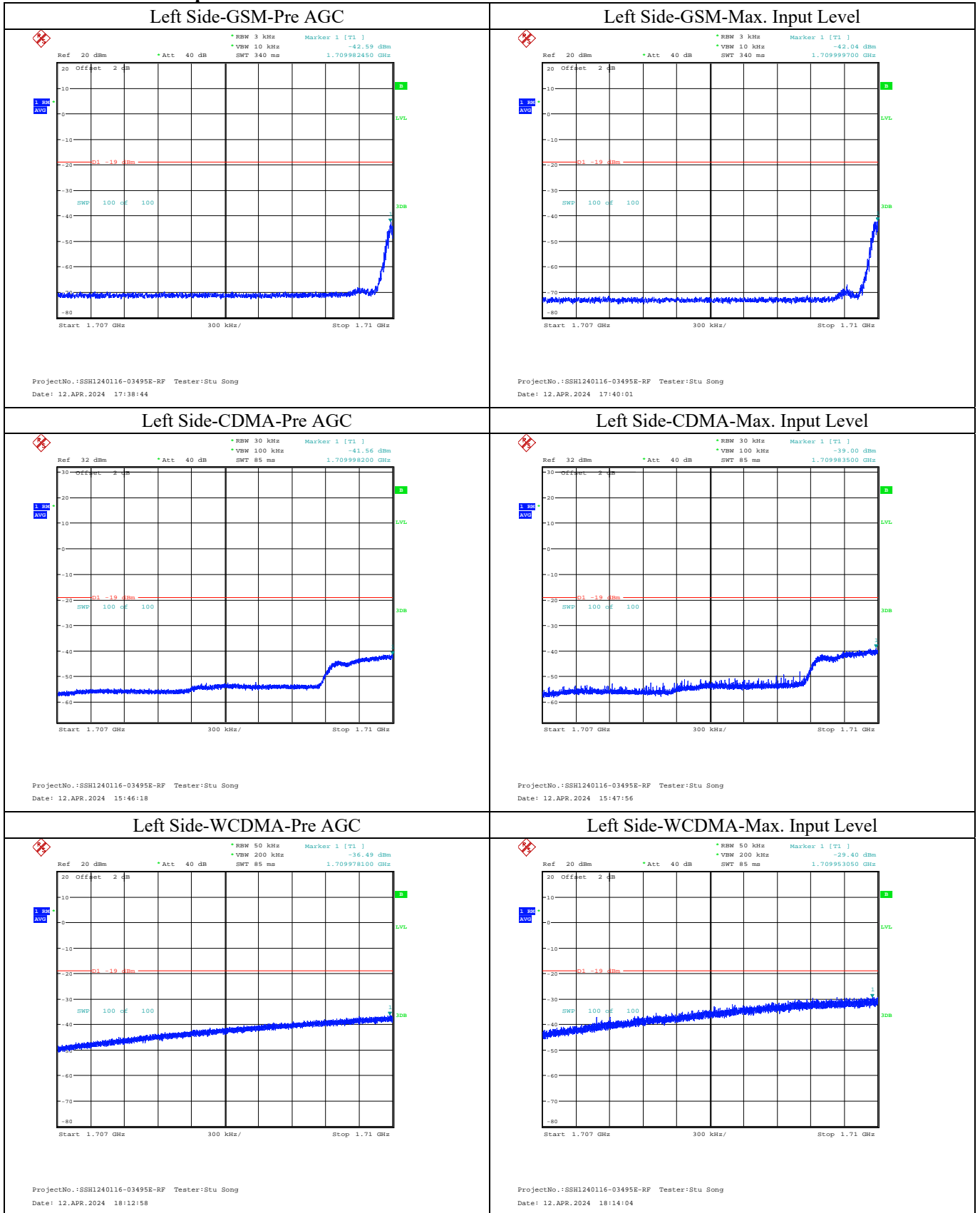

Right Side-GSM-Pre AGC

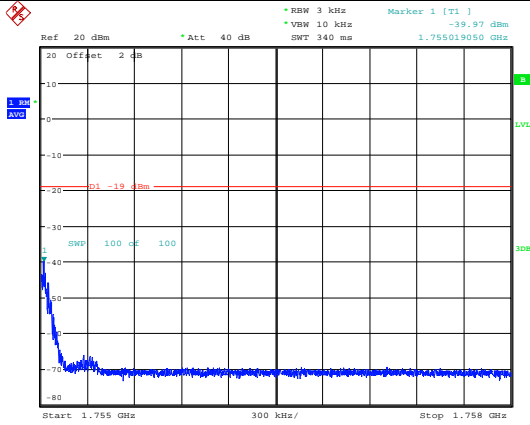

ProjectNo.:SSH1240116-03495E-RF Tester:Stu Song  
Date: 12.APR.2024 17:42:14

Right Side-GSM-Max. Input Level

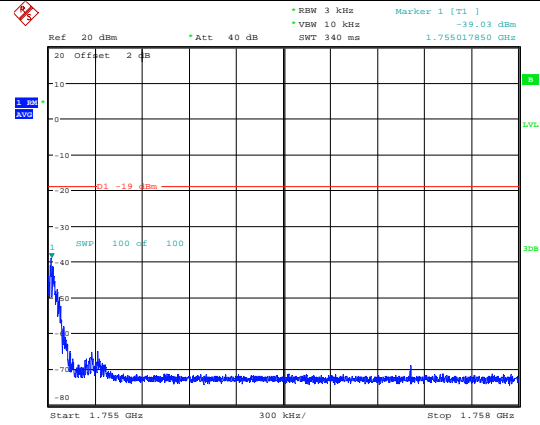

ProjectNo.:SSH1240116-03495E-RF Tester:Stu Song  
Date: 12.APR.2024 17:43:40

Right Side-CDMA-Pre AGC

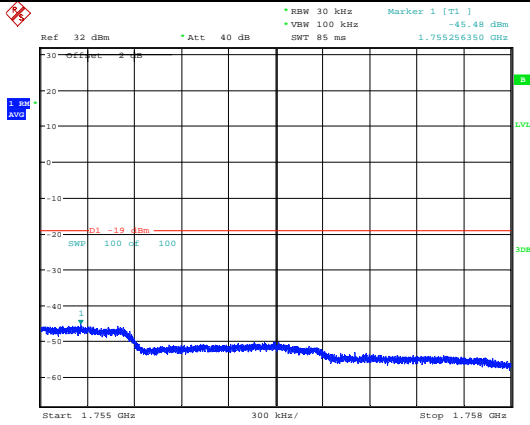

ProjectNo.:SSH1240116-03495E-RF Tester:Stu Song  
Date: 12.APR.2024 15:50:32

Right Side-CDMA-Max. Input Level

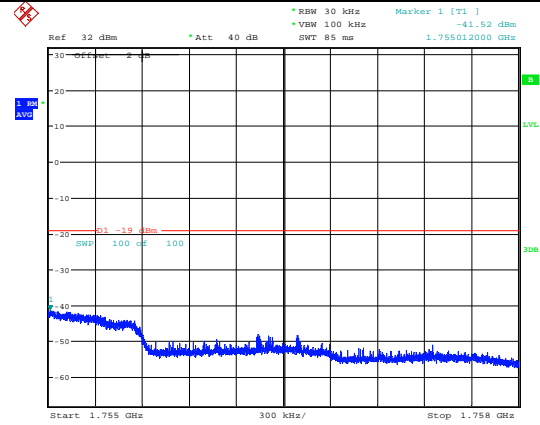

ProjectNo.:SSH1240116-03495E-RF Tester:Stu Song  
Date: 12.APR.2024 15:51:32

Right Side-WCDMA-Pre AGC

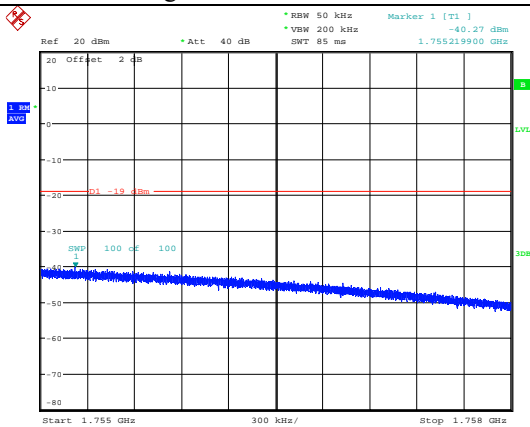

ProjectNo.:SSH1240116-03495E-RF Tester:Stu Song  
Date: 12.APR.2024 18:15:24

Right Side-WCDMA-Max. Input Level

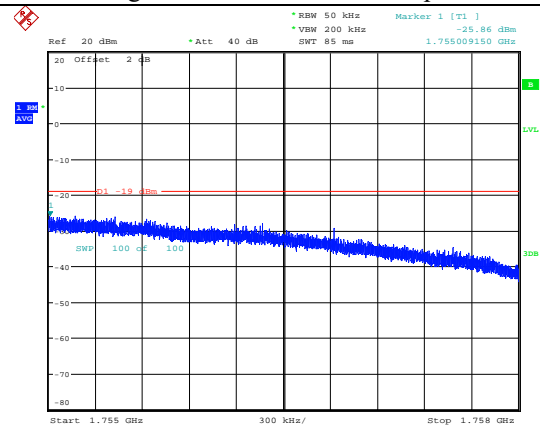

ProjectNo.:SSH1240116-03495E-RF Tester:Stu Song  
Date: 12.APR.2024 18:16:15

PCS Band Uplink

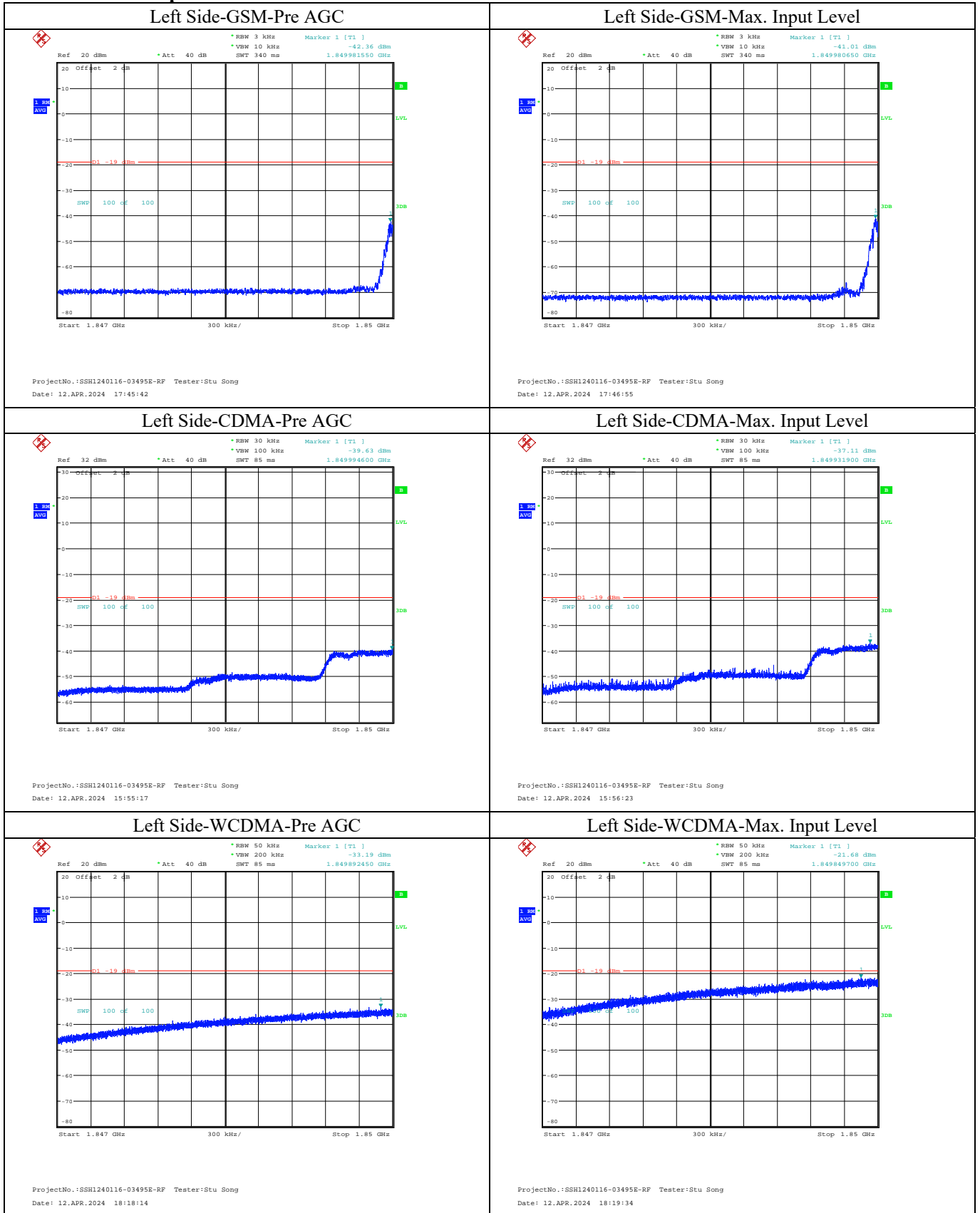

Right Side-GSM-Pre AGC

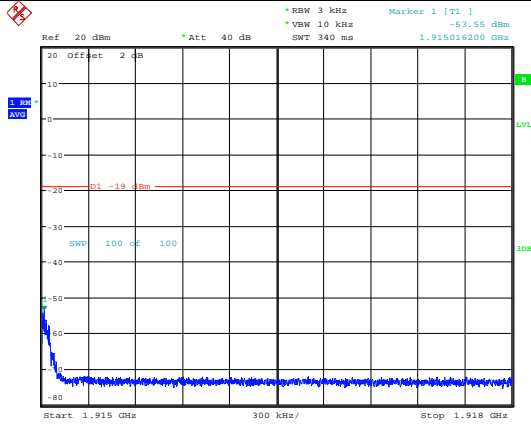

ProjectNo.:SSH1240116-03495E-RF Tester:Stu Song  
Date: 12.APR.2024 17:48:47

Right Side-GSM-Max. Input Level

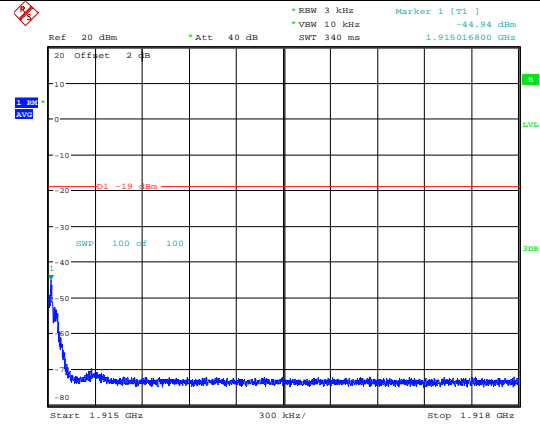

ProjectNo.:SSH1240116-03495E-RF Tester:Stu Song  
Date: 12.APR.2024 17:50:12

Right Side-CDMA-Pre AGC

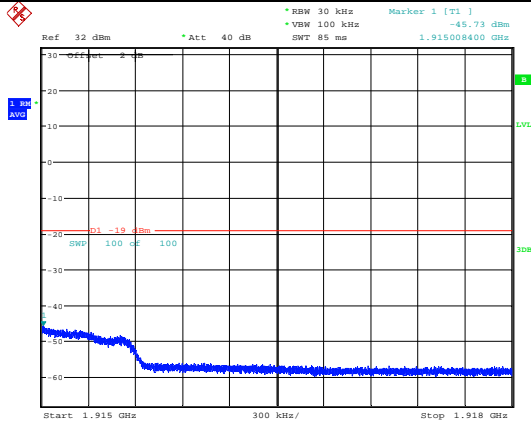

ProjectNo.:SSH1240116-03495E-RF Tester:Stu Song  
Date: 12.APR.2024 15:57:49

Right Side-CDMA-Max. Input Level

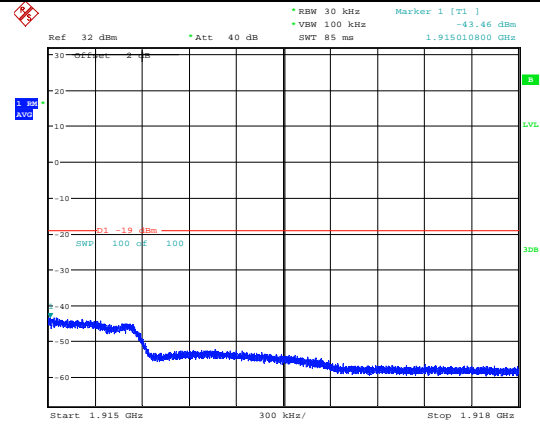

ProjectNo.:SSH1240116-03495E-RF Tester:Stu Song  
Date: 12.APR.2024 15:58:49

Right Side-WCDMA-Pre AGC

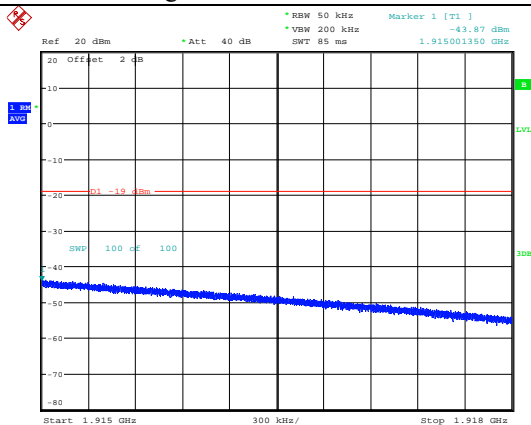

ProjectNo.:SSH1240116-03495E-RF Tester:Stu Song  
Date: 12.APR.2024 18:20:59

Right Side-WCDMA-Max. Input Level

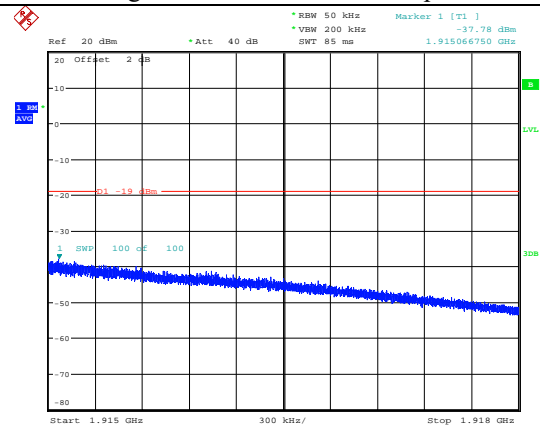

ProjectNo.:SSH1240116-03495E-RF Tester:Stu Song  
Date: 12.APR.2024 18:21:50

Lower 700M Band Downlink

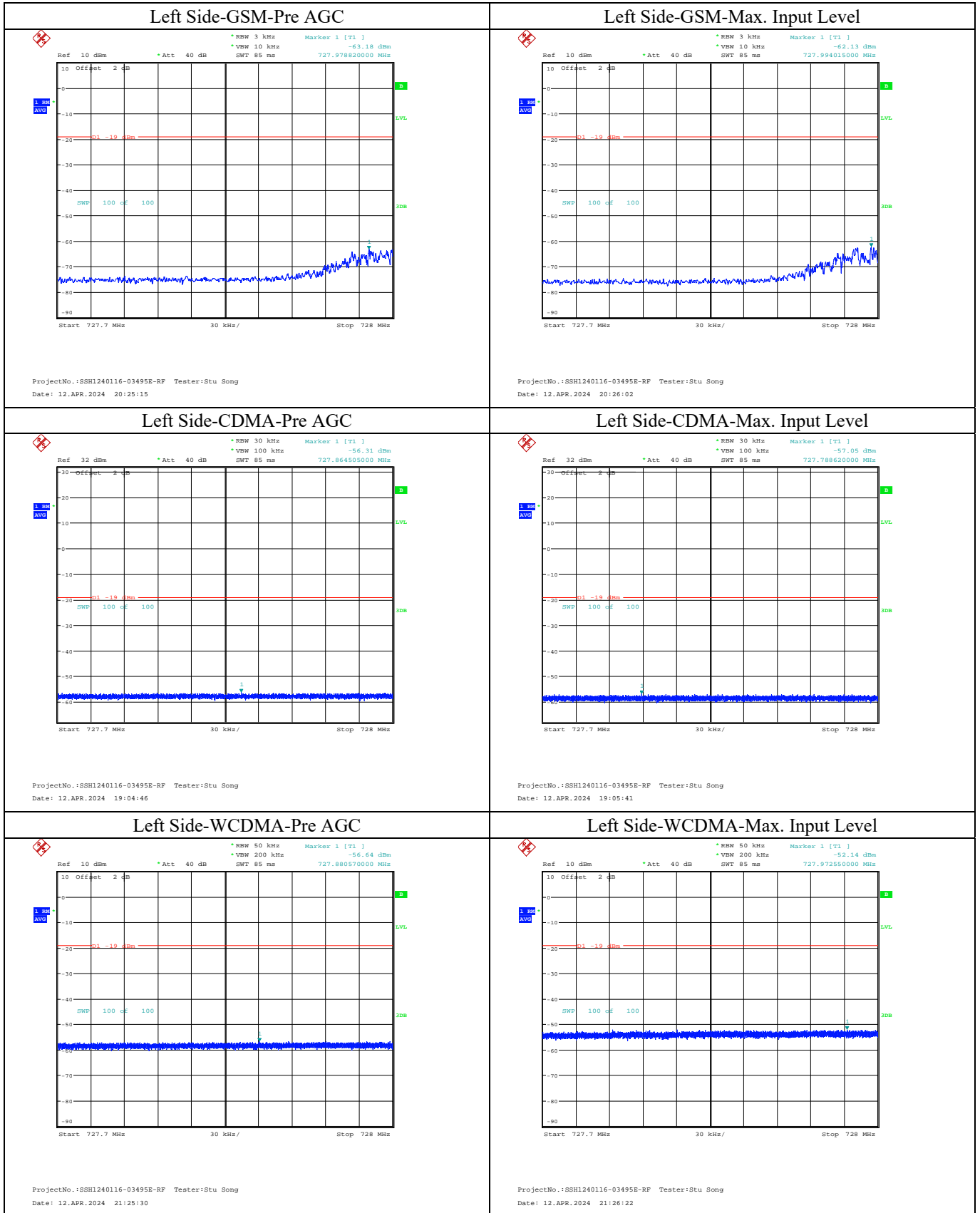



Right Side-GSM-Pre AGC

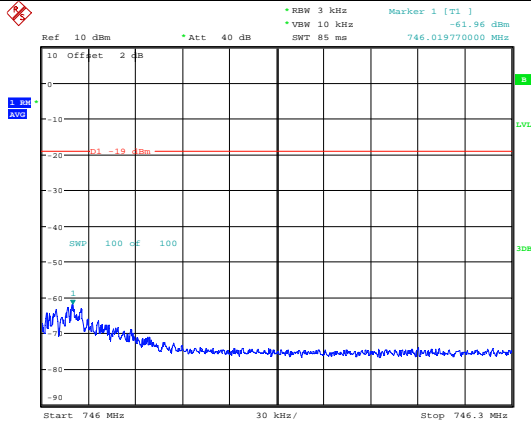

ProjectNo.:SSH1240116-03495E-RF Tester:Stu Song  
Date: 12.APR.2024 20:29:17

Right Side-GSM-Max. Input Level

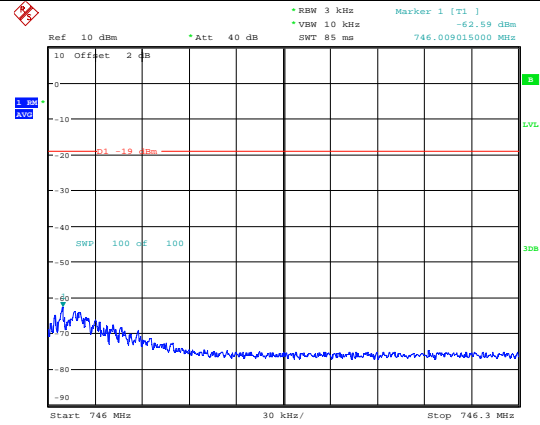

ProjectNo.:SSH1240116-03495E-RF Tester:Stu Song  
Date: 12.APR.2024 20:30:04

Right Side-CDMA-Pre AGC

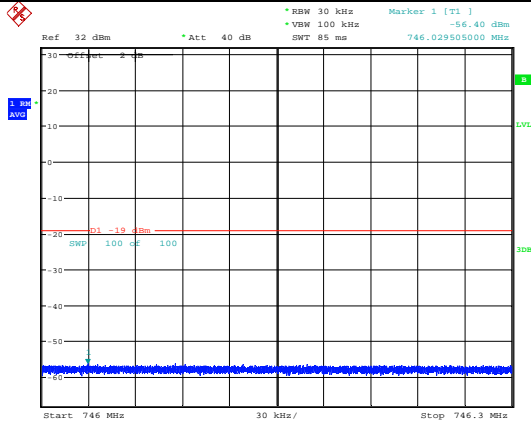

ProjectNo.:SSH1240116-03495E-RF Tester:Stu Song  
Date: 12.APR.2024 19:07:06

Right Side-CDMA-Max. Input Level

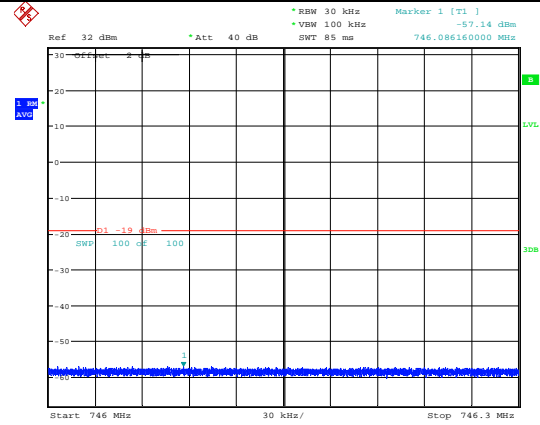

ProjectNo.:SSH1240116-03495E-RF Tester:Stu Song  
Date: 12.APR.2024 19:08:02

Right Side-WCDMA-Pre AGC

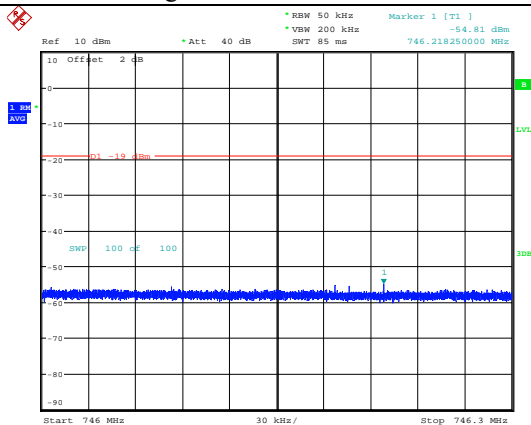

ProjectNo.:SSH1240116-03495E-RF Tester:Stu Song  
Date: 12.APR.2024 21:27:52

Right Side-WCDMA-Max. Input Level

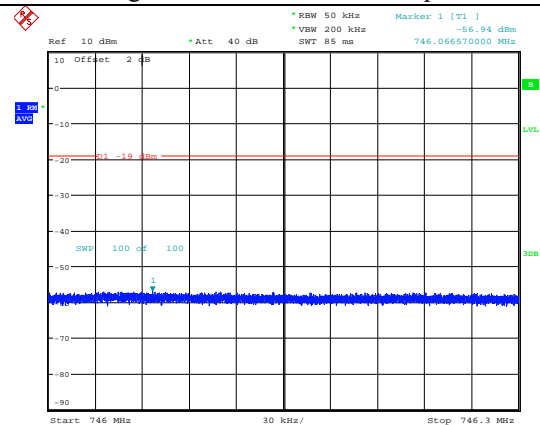

ProjectNo.:SSH1240116-03495E-RF Tester:Stu Song  
Date: 12.APR.2024 21:29:12

Upper 700M Band Downlink

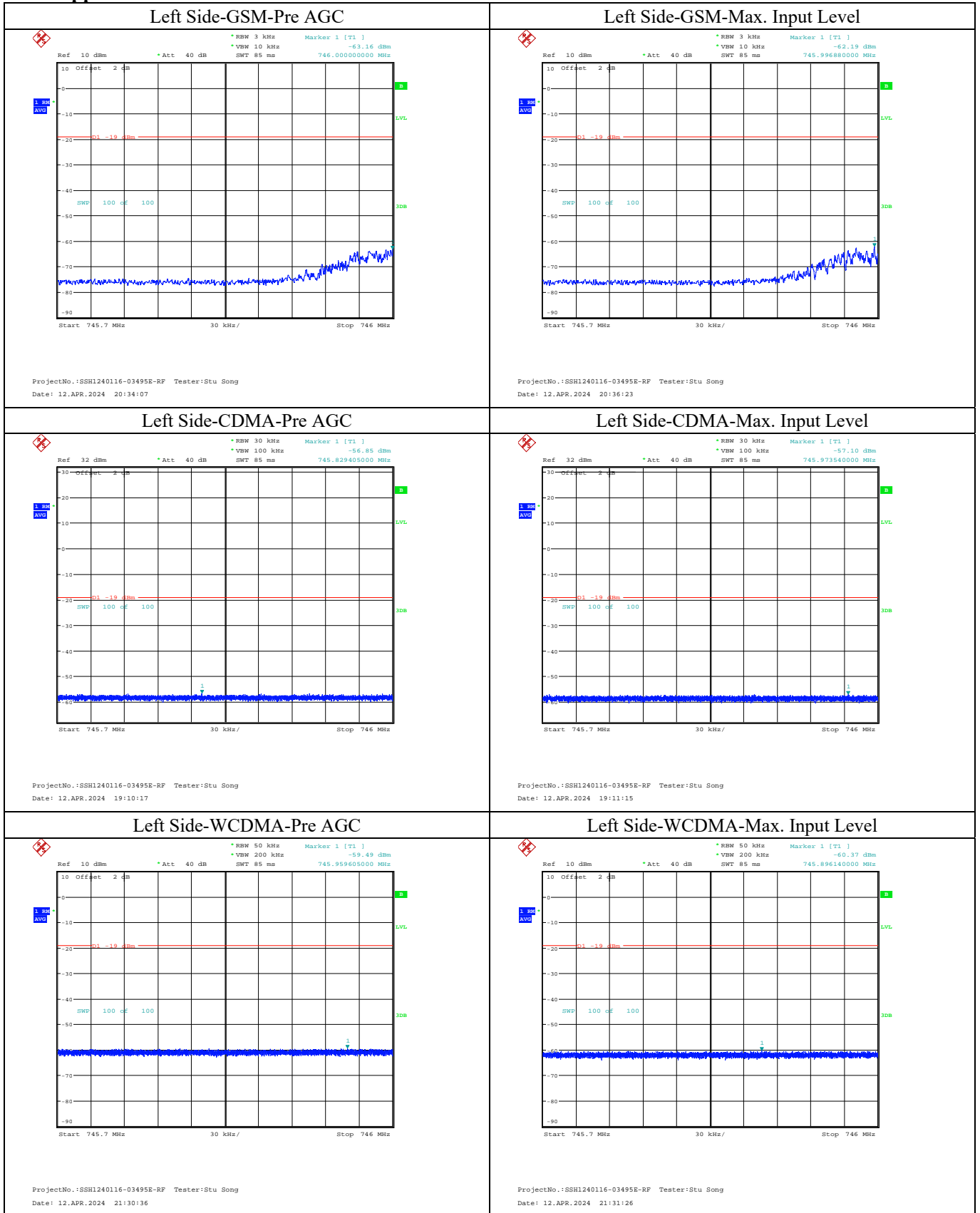

Right Side-GSM-Pre AGC

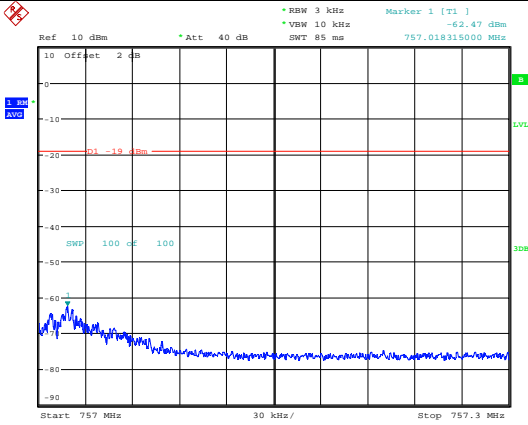

ProjectNo.:SSH1240116-03495E-RF Tester:Stu Song  
Date: 12.APR.2024 20:37:44

Right Side-GSM-Max. Input Level

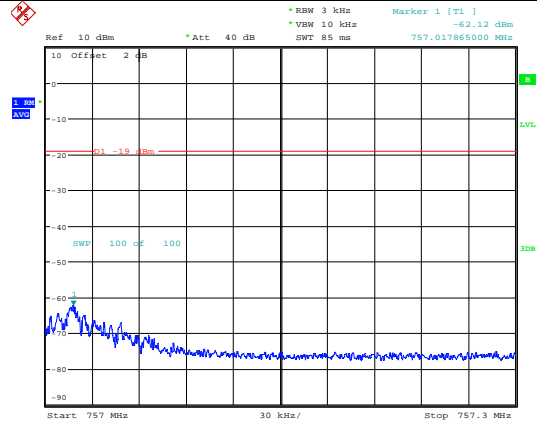

ProjectNo.:SSH1240116-03495E-RF Tester:Stu Song  
Date: 12.APR.2024 20:38:36

Right Side-CDMA-Pre AGC

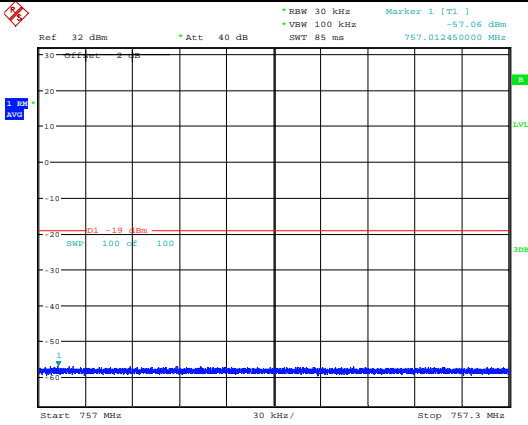

ProjectNo.:SSH1240116-03495E-RF Tester:Stu Song  
Date: 12.APR.2024 19:13:55

Right Side-CDMA-Max. Input Level

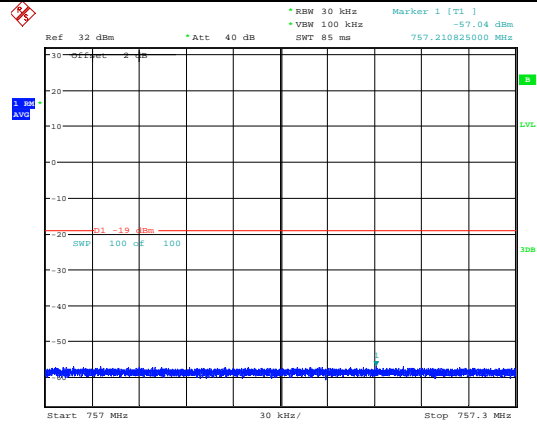

ProjectNo.:SSH1240116-03495E-RF Tester:Stu Song  
Date: 12.APR.2024 19:14:54

Right Side-WCDMA-Pre AGC

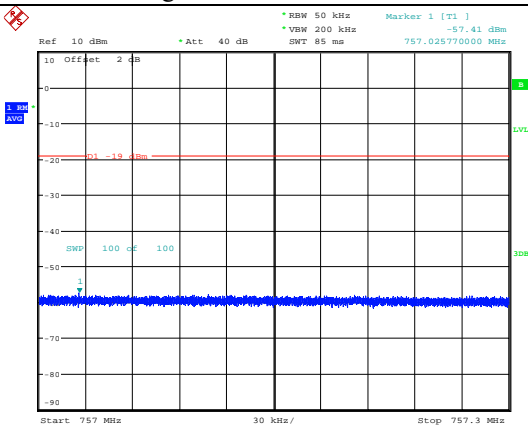

ProjectNo.:SSH1240116-03495E-RF Tester:Stu Song  
Date: 12.APR.2024 21:32:40

Right Side-WCDMA-Max. Input Level

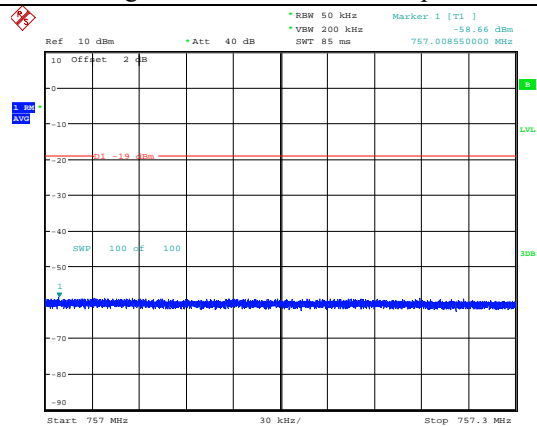

ProjectNo.:SSH1240116-03495E-RF Tester:Stu Song  
Date: 12.APR.2024 21:33:35

**Cellular Band Downlink:**

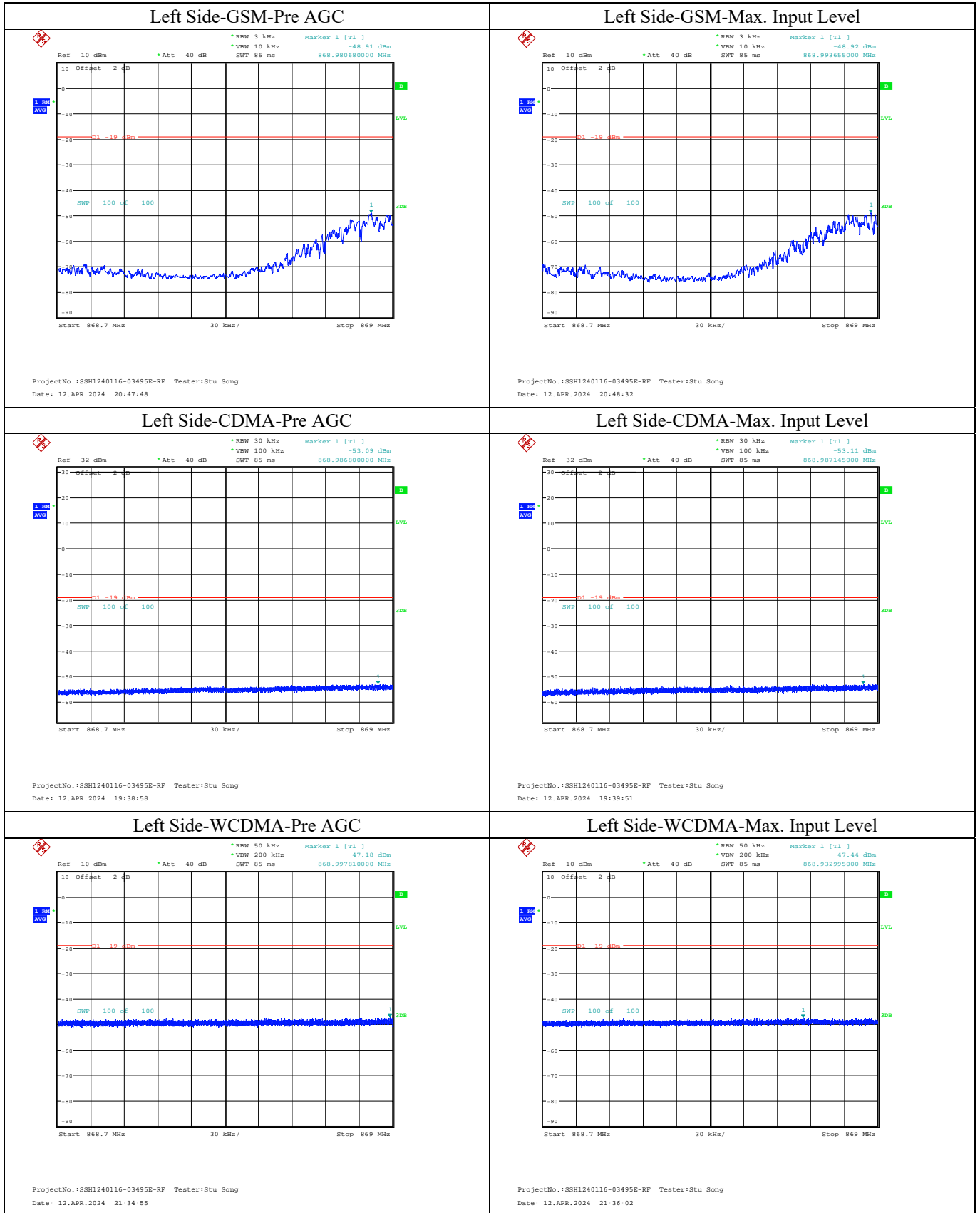

Right Side-GSM-Pre AGC

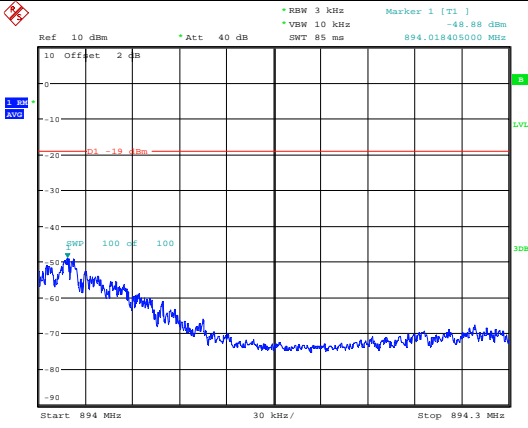

ProjectNo.:SSH1240116-03495E-RF Tester:Stu Song  
Date: 12.APR.2024 20:49:43

Right Side-GSM-Max. Input Level

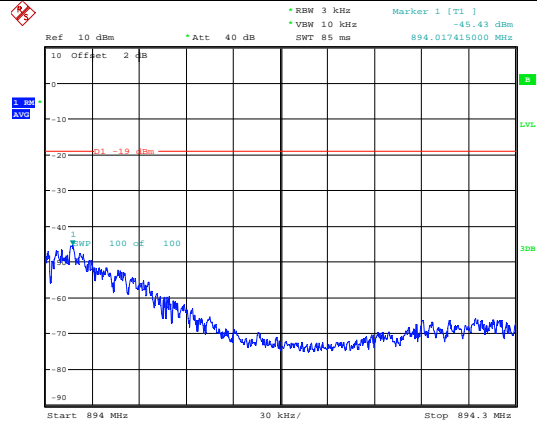

ProjectNo.:SSH1240116-03495E-RF Tester:Stu Song  
Date: 12.APR.2024 20:50:29

Right Side-CDMA-Pre AGC

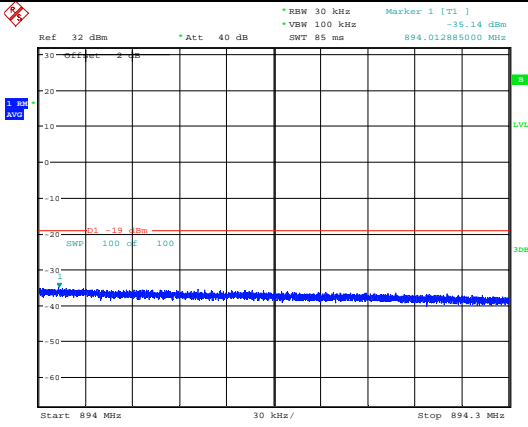

ProjectNo.:SSH1240116-03495E-RF Tester:Stu Song  
Date: 12.APR.2024 19:41:14

Right Side-CDMA-Max. Input Level

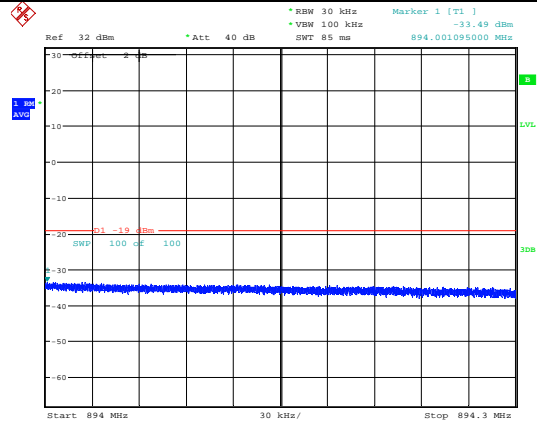

ProjectNo.:SSH1240116-03495E-RF Tester:Stu Song  
Date: 12.APR.2024 19:42:03

Right Side-WCDMA-Pre AGC

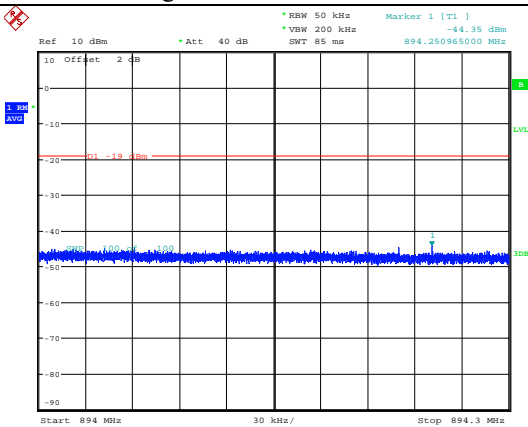

ProjectNo.:SSH1240116-03495E-RF Tester:Stu Song  
Date: 12.APR.2024 21:37:13

Right Side-WCDMA-Max. Input Level

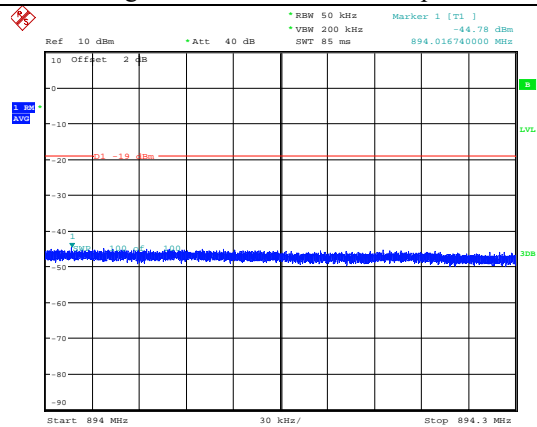

ProjectNo.:SSH1240116-03495E-RF Tester:Stu Song  
Date: 12.APR.2024 21:38:00

**AWS-1 Band Downlink**

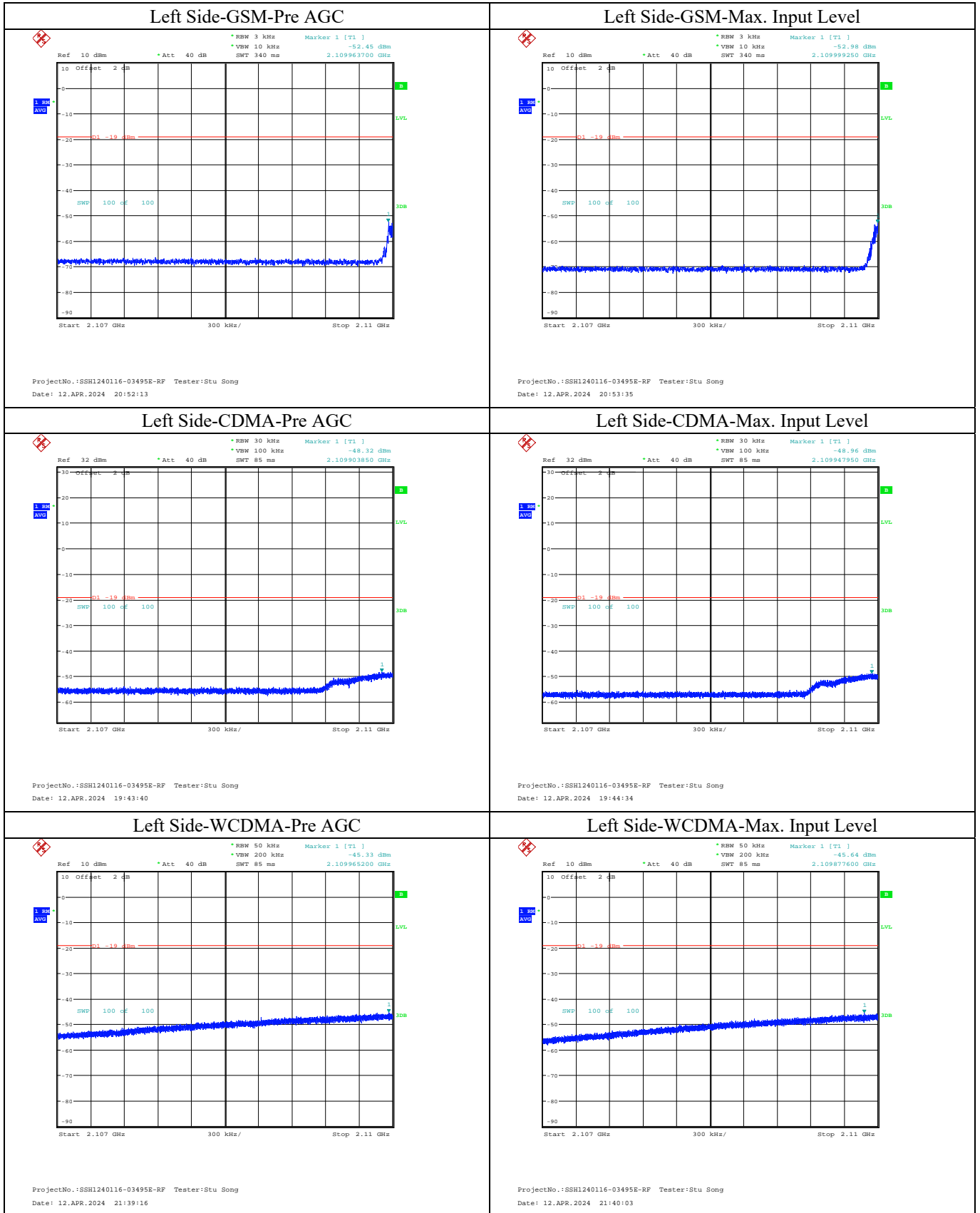

Right Side-GSM-Pre AGC

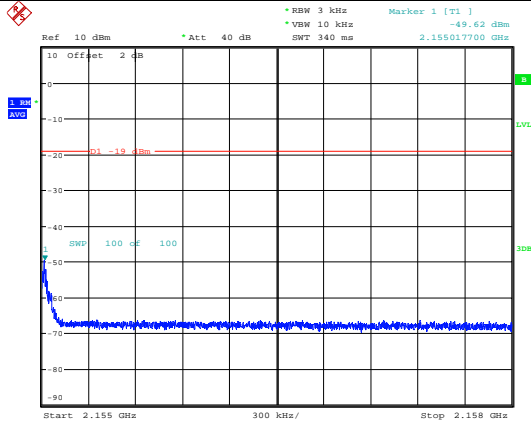

ProjectNo.:SSH1240116-03495E-RF Tester:Stu Song  
Date: 12.APR.2024 20:55:11

Right Side-GSM-Max. Input Level

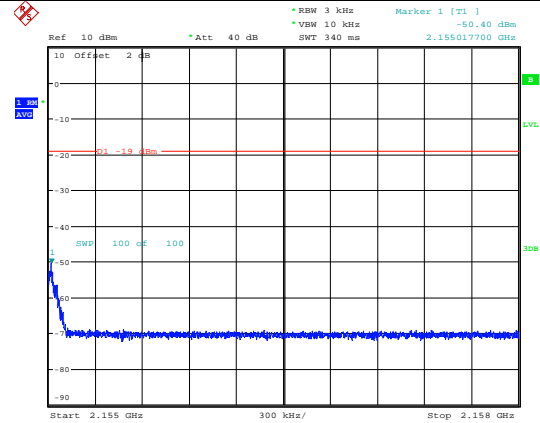

ProjectNo.:SSH1240116-03495E-RF Tester:Stu Song  
Date: 12.APR.2024 20:56:22

Right Side-CDMA-Pre AGC

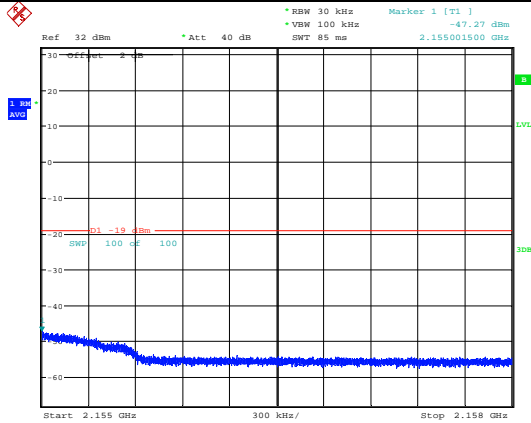

ProjectNo.:SSH1240116-03495E-RF Tester:Stu Song  
Date: 12.APR.2024 19:45:55

Right Side-CDMA-Max. Input Level

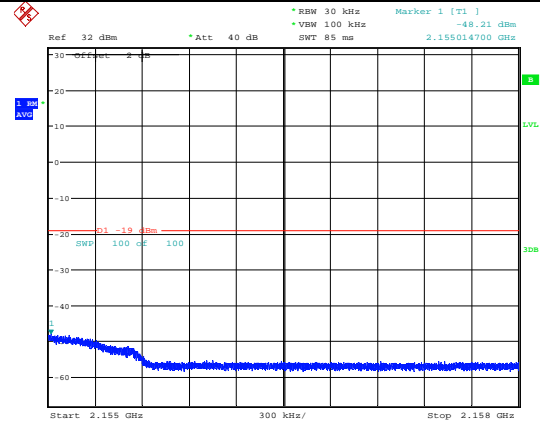

ProjectNo.:SSH1240116-03495E-RF Tester:Stu Song  
Date: 12.APR.2024 19:46:55

Right Side-WCDMA-Pre AGC

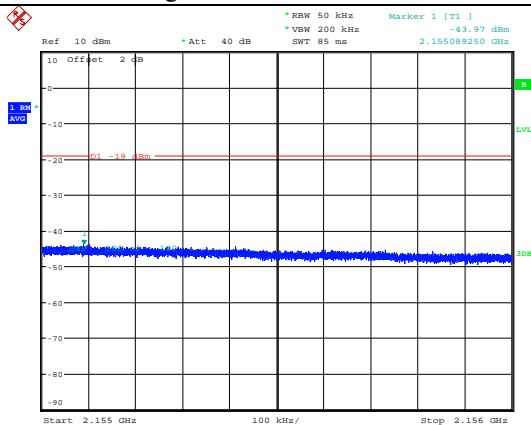

ProjectNo.:SSH1240116-03495E-RF Tester:Stu Song  
Date: 12.APR.2024 21:45:45

Right Side-WCDMA-Max. Input Level

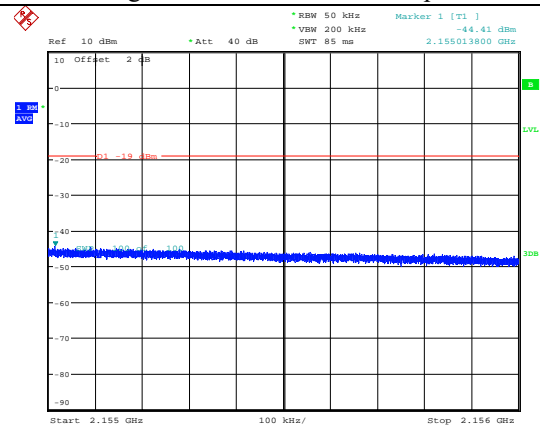

ProjectNo.:SSH1240116-03495E-RF Tester:Stu Song  
Date: 12.APR.2024 21:46:42

PCS Band Downlink

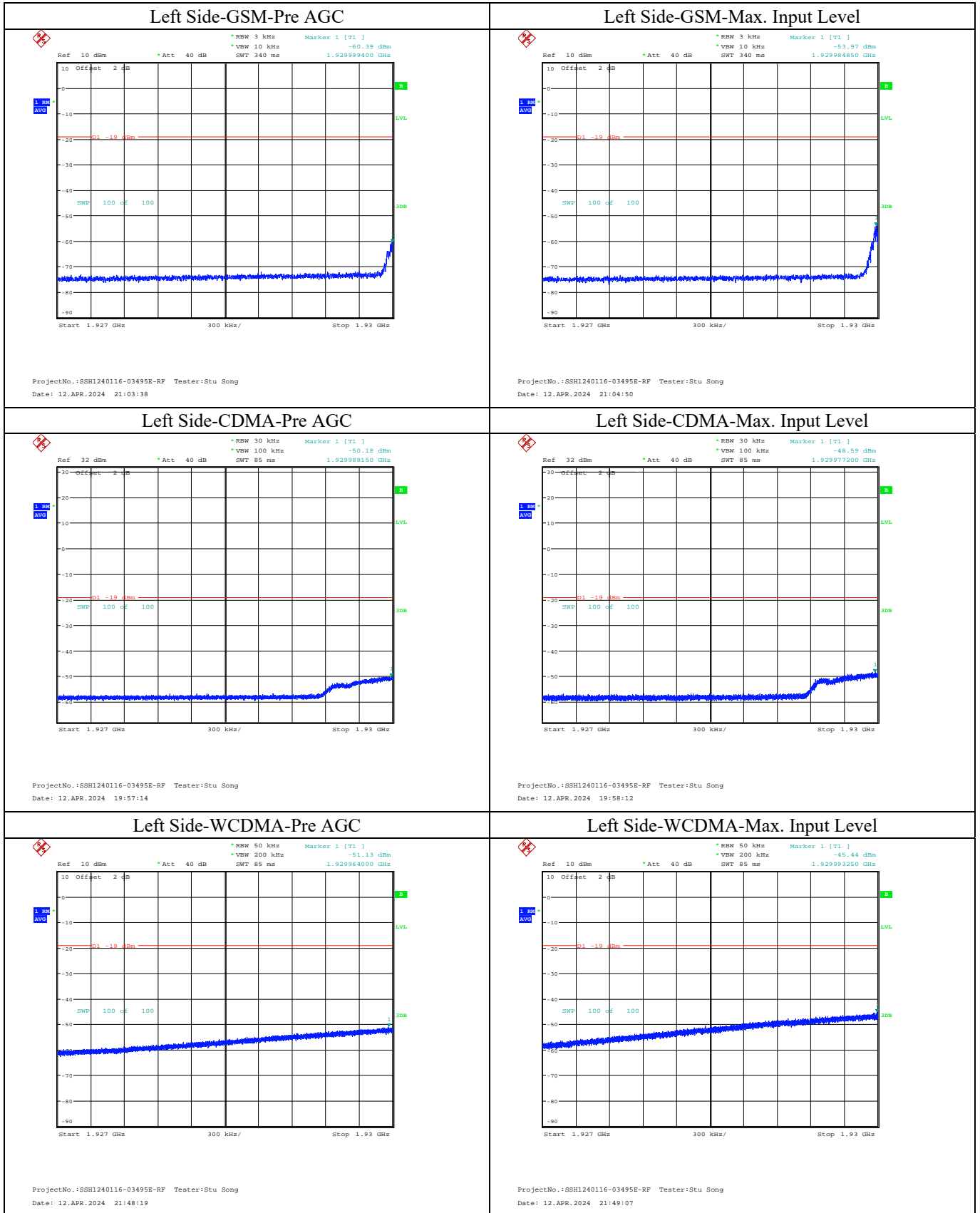



Right Side-GSM-Pre AGC

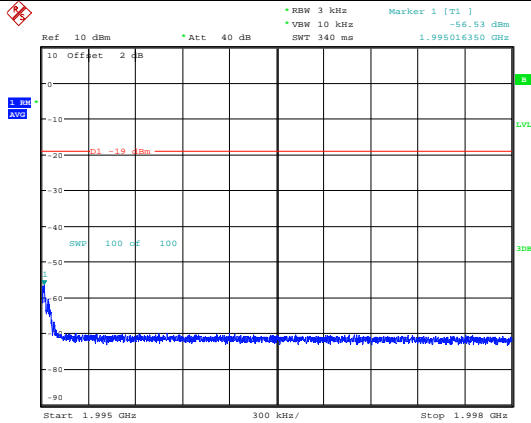

ProjectNo.:SSH1240116-03495E-RF Tester:Stu Song  
 Date: 12.APR.2024 21:06:32

Right Side-GSM-Max. Input Level

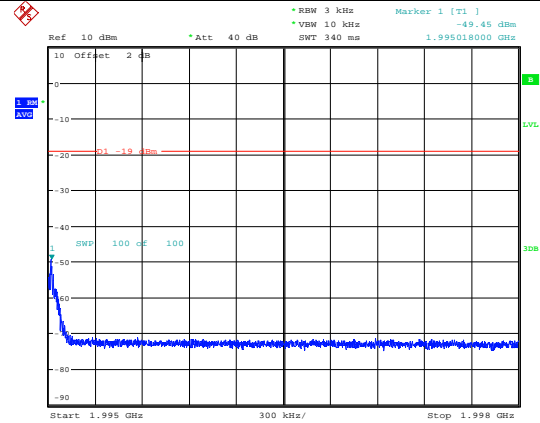

ProjectNo.:SSH1240116-03495E-RF Tester:Stu Song  
 Date: 12.APR.2024 21:07:42

Right Side-CDMA-Pre AGC

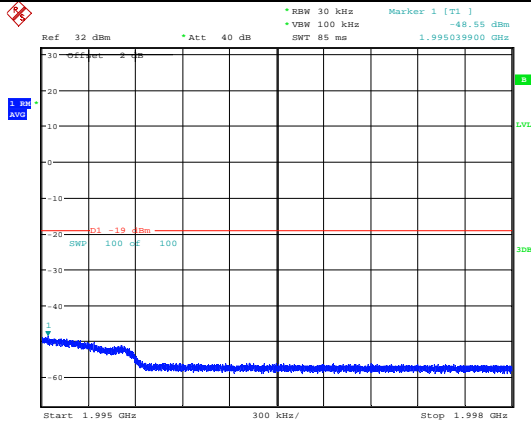

ProjectNo.:SSH1240116-03495E-RF Tester:Stu Song  
 Date: 12.APR.2024 19:59:39

Right Side-CDMA-Max. Input Level

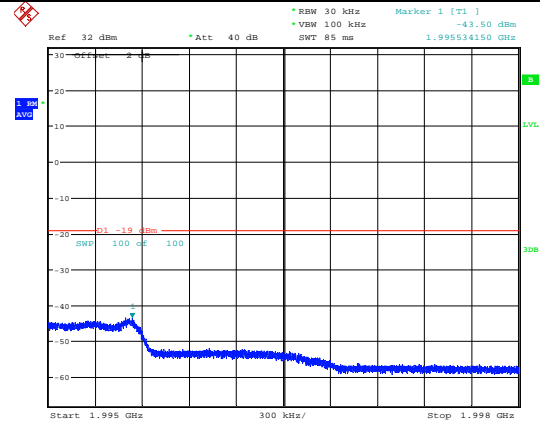

ProjectNo.:SSH1240116-03495E-RF Tester:Stu Song  
 Date: 12.APR.2024 20:00:41

Right Side-WCDMA-Pre AGC

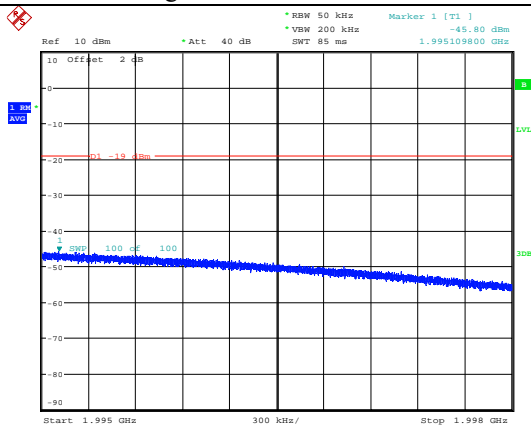

ProjectNo.:SSH1240116-03495E-RF Tester:Stu Song  
 Date: 12.APR.2024 21:50:14

Right Side-WCDMA-Max. Input Level

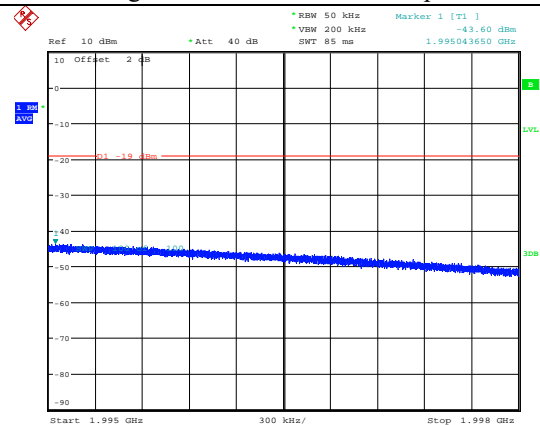

ProjectNo.:SSH1240116-03495E-RF Tester:Stu Song  
 Date: 12.APR.2024 21:52:20

## 4.6 Spurious Emissions at Antenna Terminals

### 4.6.1 Applicable Standard

According to §2.1051 *Measurements required: Spurious emissions at antenna terminals.*

§20.21(e)(8)(i)(E): Booster out of band emissions (OOBE) shall be at least 6 dB below the FCC's mobile emission limits for the supported bands of operation. Compliance to OOBE limits will utilize high peak-to-average CMRS signal types.

§22.917 (a) Out of band emissions. The power of any emission outside of the authorized operating frequency ranges must be attenuated below the transmitting power (P) by a factor of at least  $43 + 10 \log(P)$  dB.

§24.238 (a) Out of band emissions. The power of any emission outside of the authorized operating frequency ranges must be attenuated below the transmitting power (P) by a factor of at least  $43 + 10 \log(P)$  dB.

§27.53: the power of any emission shall be attenuated outside the band below the transmitter power (P) by at least  $43 + 10 \log(P)$  dB;

### 4.6.2 Test Procedure

KDB 935210 D03 Signal Booster Measurements v04r04 Clause 7.5

The following procedures shall be used to demonstrate compliance to the applicable conducted spurious emissions limits as per Section 2.1051.

*NOTE—For frequencies below 1 GHz, an RBW of 1 MHz may be used in a preliminary measurement. If non-compliant emissions are detected, a final measurement shall be made with a 100 kHz RBW. Additionally, a peak detector may also be used for the preliminary measurement. If non-compliant emissions are detected then a final measurement of these emissions shall be made with the power averaging (rms) detector.*

- a) Connect the EUT to the test equipment as shown in **Figure 1**. Begin with the uplink output (donor) port connected to the spectrum analyzer.
- b) Configure the signal generator for AWGN with a 99% OBW of 4.1 MHz, with a center frequency corresponding to the center of the CMRS band under test.
- c) Set the signal generator amplitude to the level determined in the power measurement procedure in 7.2.
- d) Turn on the signal generator RF output and measure the spurious emission power levels with an appropriate measuring instrument as follows.
  - 1) Set RBW = measurement bandwidth specified in the applicable rule section for the operational frequency band under consideration (see Appendix A for relevant cross-references). Note that many of the individual rule sections permit the use of a narrower RBW [typically  $\geq 1\%$  of the emission bandwidth (EBW)] to enhance measurement accuracy, but the result must then be integrated over the specified measurement bandwidth.
  - 2) Set VBW =  $3 * RBW$ .
  - 3) Select the power averaging (rms) detector. (See above note regarding the use of a peak detector for preliminary measurements.)
  - 4) Sweep time = auto-couple.

- 5) Set the analyzer start frequency to the lowest radio frequency signal generated in the equipment, without going below 9 kHz, and the stop frequency to the lower band/block edge frequency minus 100 kHz or 1 MHz, as specified in the applicable rule part. Note that the number of measurement points in each sweep must be  $\geq (2 \text{ span/RBW})$ , which may require that the measurement range defined by the preceding start and stop frequencies be subdivided, depending on the available number of measurement points of the spectrum analyzer. Trace average at least 10 traces in power averaging (i.e., rms) mode.
  - 6) Sweep time = auto-couple.
  - 7) Use the peak marker function to identify the highest amplitude level over each measured frequency range. Record the frequency and amplitude and capture a plot for inclusion in the test report.
  - 8) Reset the analyzer start frequency to the upper band/block edge frequency plus 100 kHz or 1 MHz, as specified in the applicable rule part, and the analyzer stop frequency to 10 times the highest frequency of the fundamental emission. Note that the number of measurement points in each sweep must be  $\geq (2 \cdot \text{span/RBW})$  which may require that the measurement range defined by the start and stop frequencies above be subdivided, depending on the available number of measurement points provided by the spectrum analyzer.
  - 9) Use the peak marker function to identify the highest amplitude level over each of the measured frequency ranges. Record the frequency and amplitude and capture a plot for inclusion in the test report.
- e) Repeat 7.6b) through 7.6d) for each supported frequency band of operation.

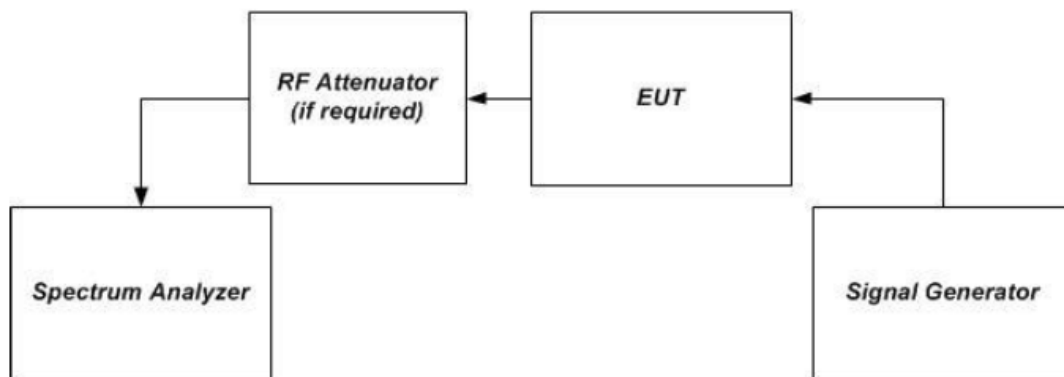

Figure 1 – Band verification test instrumentation setup

**4.6.3 Test Result**

Serial Number:	2G05-5	Test Date:	2024/2/27~2024/2/28
Test Site:	RF	Test Mode:	Transmitting
Tester:	Stu Song	Test Result:	Pass

**Environmental Conditions:**

Temperature: (°C)	20.5~21.6	Relative Humidity: (%)	38~39	ATM Pressure: (kPa)	101.8~102.1
----------------------	-----------	------------------------------	-------	------------------------	-------------

**Test Equipment List and Details:**

Manufacturer	Description	Model	Serial Number	Calibration Date	Calibration Due Date
R&S	Spectrum Analyzer	FSU 26	200160/026	2023/10/18	2024/10/17
yzjingcheng	Coaxial Cable	KTRFBU-141-50	41010012	2023/9/1	2024/8/31
yzjingcheng	Coaxial Cable	KTRFBU-141-50	41010013	2023/9/1	2024/8/31
Eastsheep	Coaxial Attenuator	5W-N-JK-6G-10dB	F-08-EM502	2023/9/10	2024/9/9
Agilent	MXG Vector Signal Generator	N5182B	MY51350142	2023/9/1	2024/8/31

*\* Statement of Traceability: Bay Area Compliance Laboratories Corp. (Dongguan) attests that all calibrations have been performed, traceable to National Primary Standards and International System of Units (SI).*

**Test Data:**  
**Uplink**

**Lower 700MHz Band**

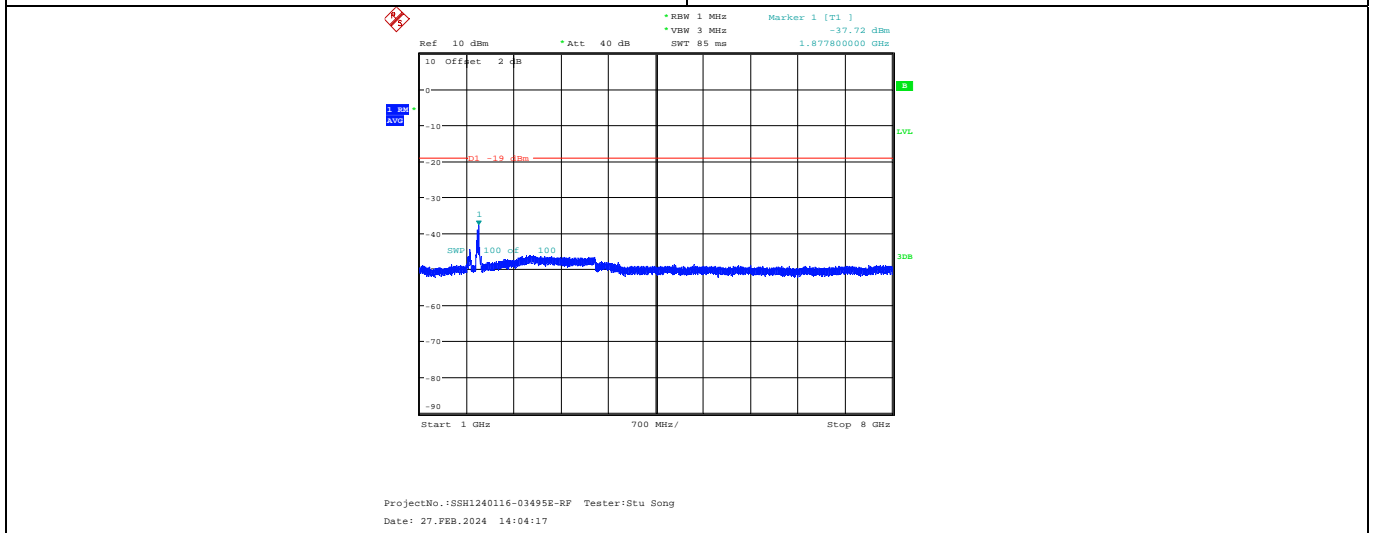
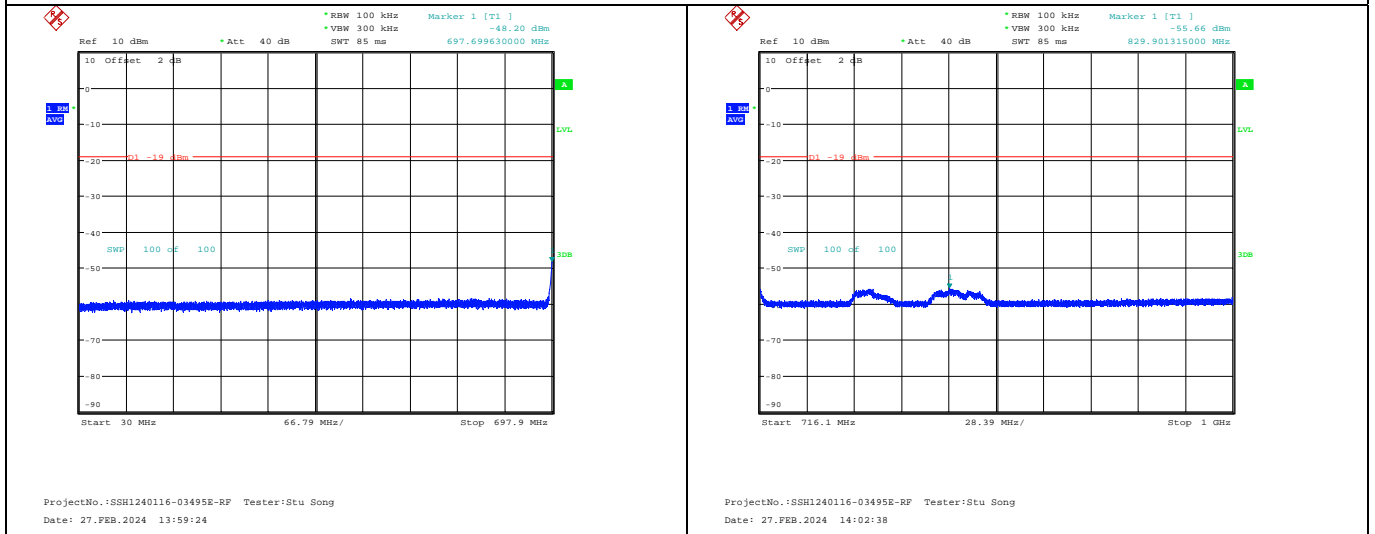

### Upper 700MHz Band

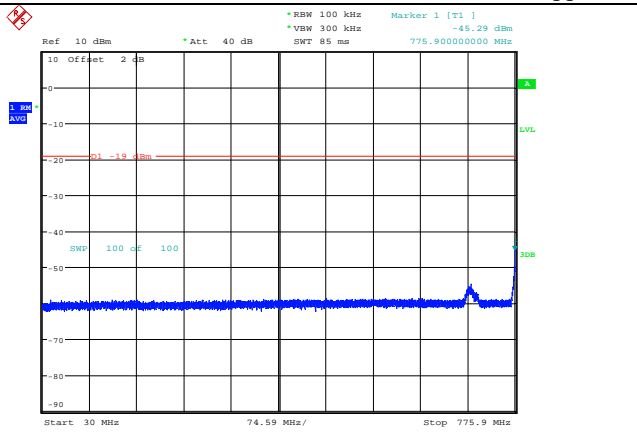

ProjectNo.:SSH1240116-03495E-RF Tester:Stu Song  
Date: 27.FEB.2024 14:07:05

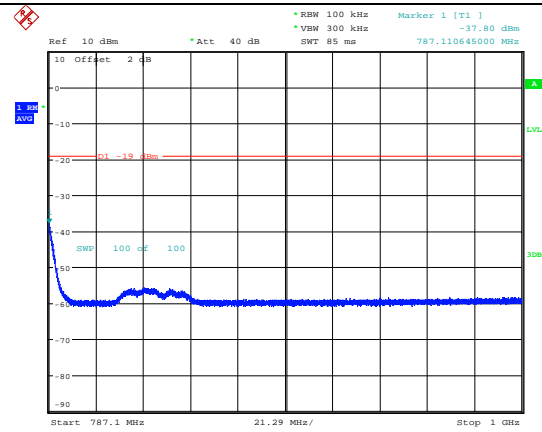

ProjectNo.:SSH1240116-03495E-RF Tester:Stu Song  
Date: 27.FEB.2024 14:11:46

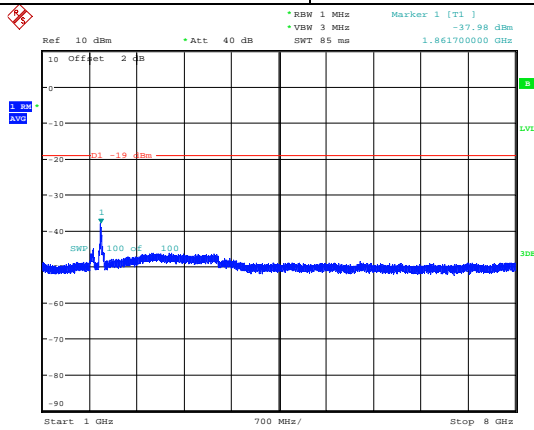

ProjectNo.:SSH1240116-03495E-RF Tester:Stu Song  
Date: 27.FEB.2024 14:14:16

Cellular Band

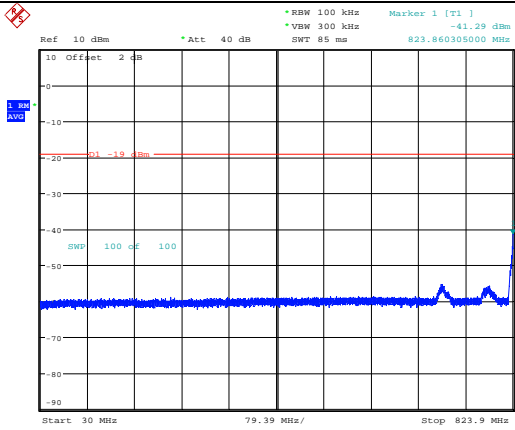

ProjectNo.:SSH1240116-03495E-RF Tester:Stu Song  
Date: 27.FEB.2024 14:21:14

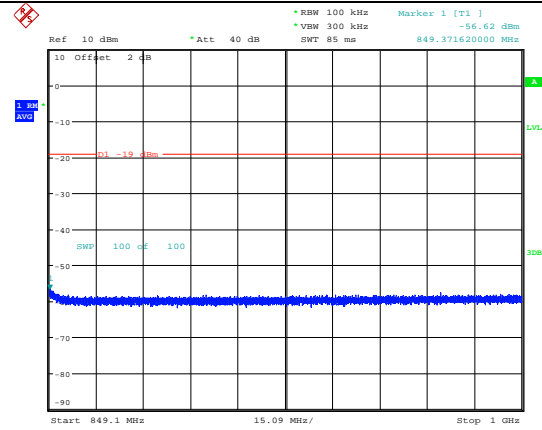

ProjectNo.:SSH1240116-03495E-RF Tester:Stu Song  
Date: 27.FEB.2024 14:22:31

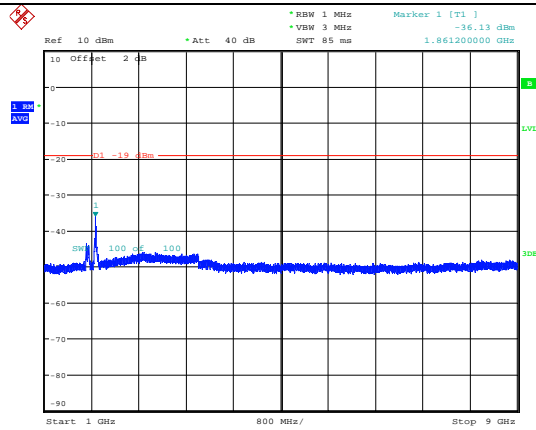

ProjectNo.:SSH1240116-03495E-RF Tester:Stu Song  
Date: 27.FEB.2024 14:23:36

AWS-1 Band

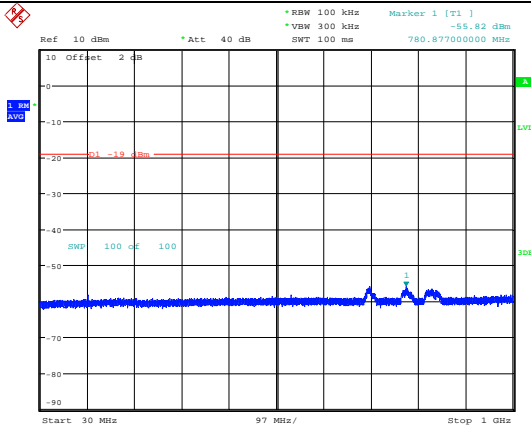

ProjectNo.:SSH1240116-03495E-RF Tester:Stu Song  
Date: 27.FEB.2024 14:29:20

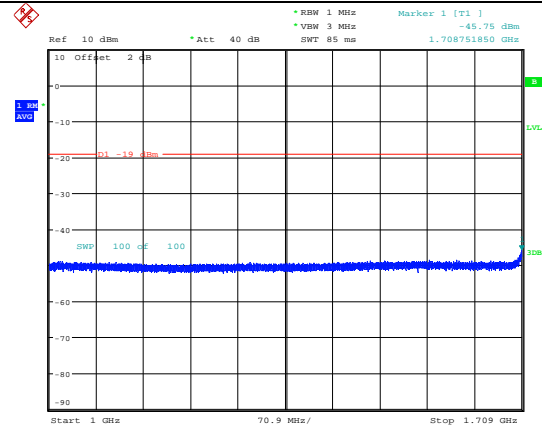

ProjectNo.:SSH1240116-03495E-RF Tester:Stu Song  
Date: 27.FEB.2024 14:31:50

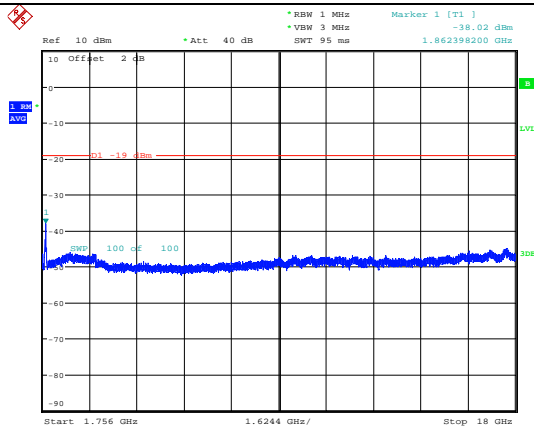

ProjectNo.:SSH1240116-03495E-RF Tester:Stu Song  
Date: 27.FEB.2024 14:33:53



PCS Band

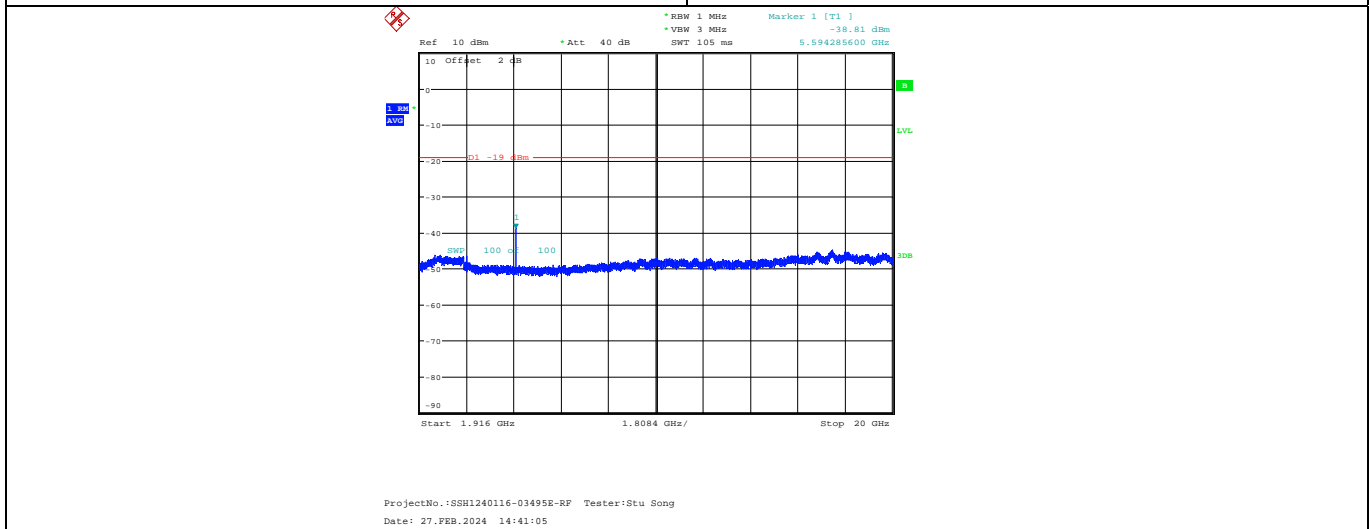
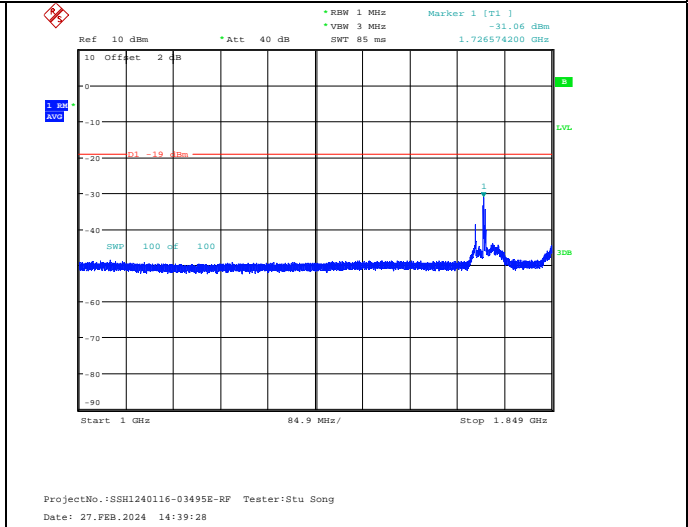
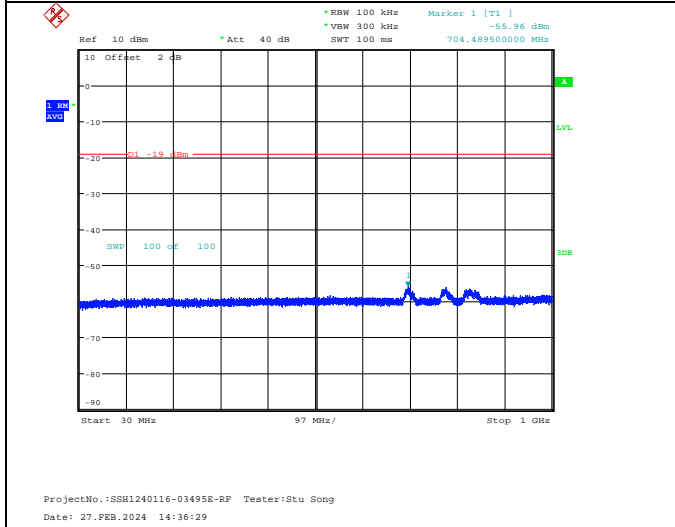

Downlink

Lower 700MHz Band

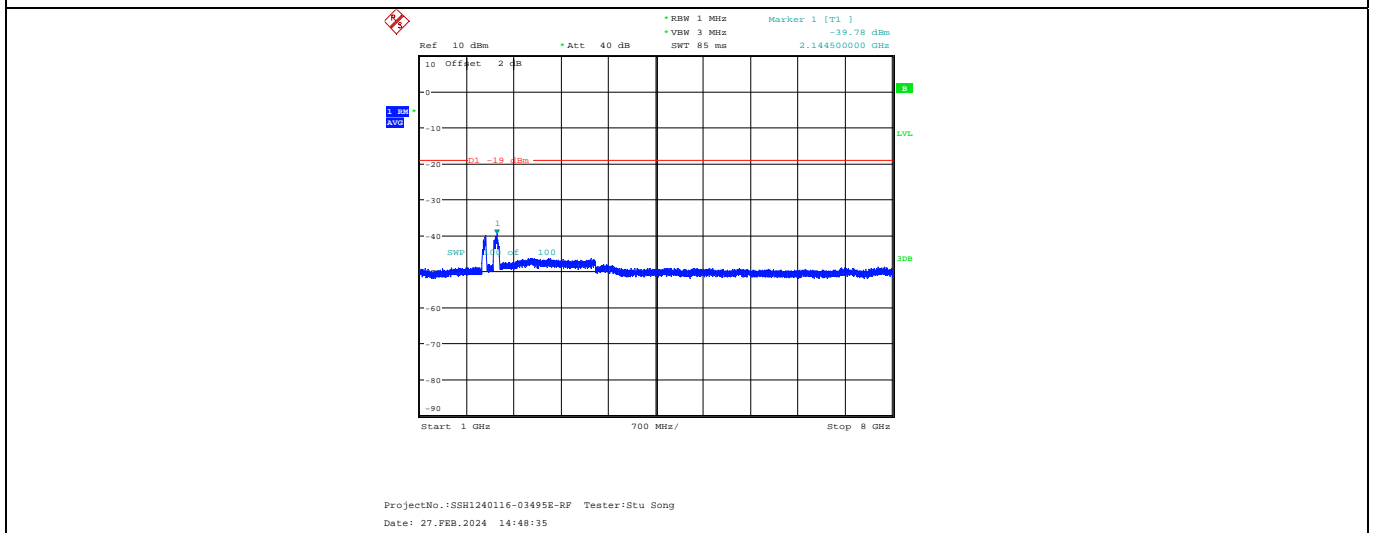
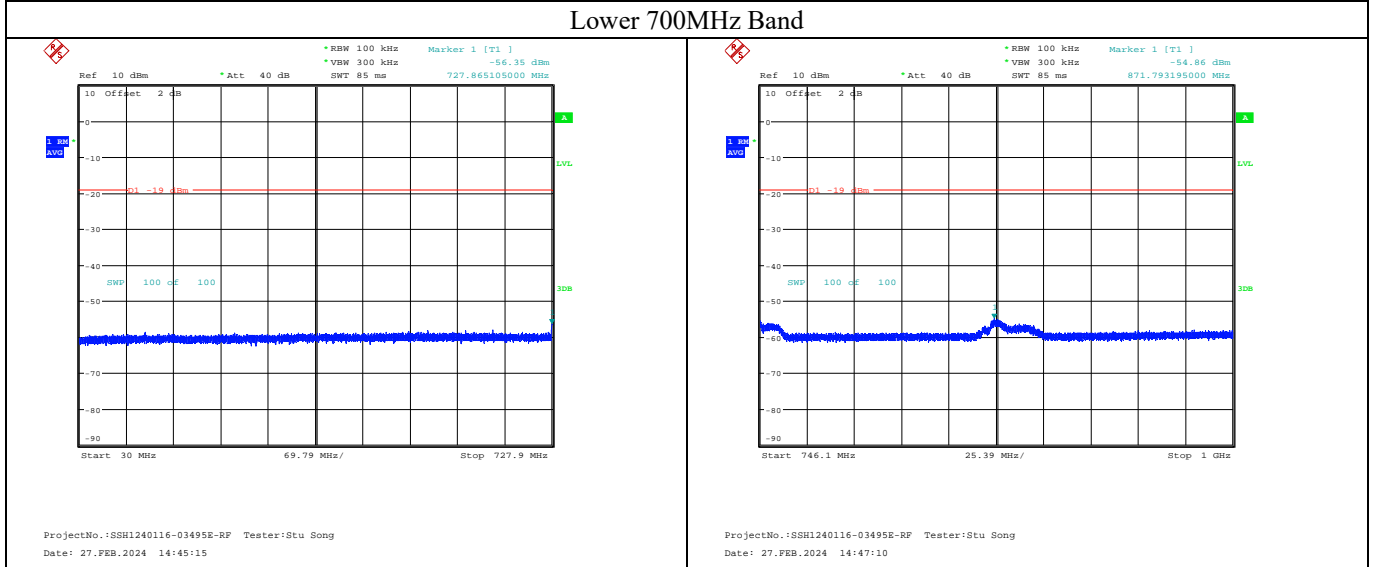

### Upper 700MHz Band

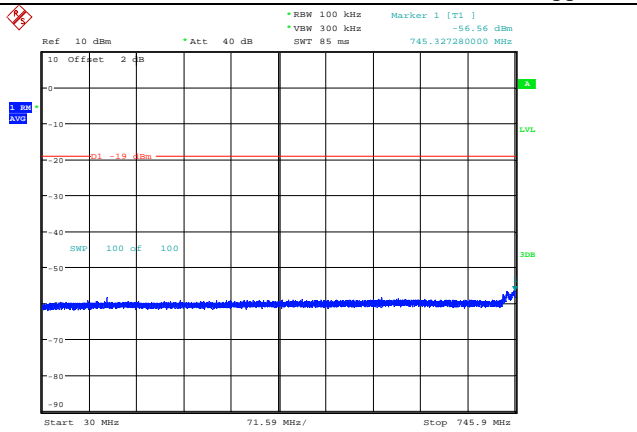

ProjectNo.:SSH1240116-03495E-RF Tester:Stu Song  
Date: 27.FEB.2024 14:51:14

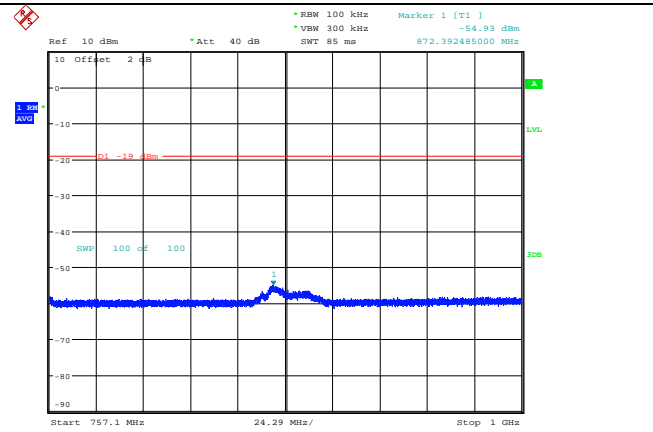

ProjectNo.:SSH1240116-03495E-RF Tester:Stu Song  
Date: 27.FEB.2024 14:52:48

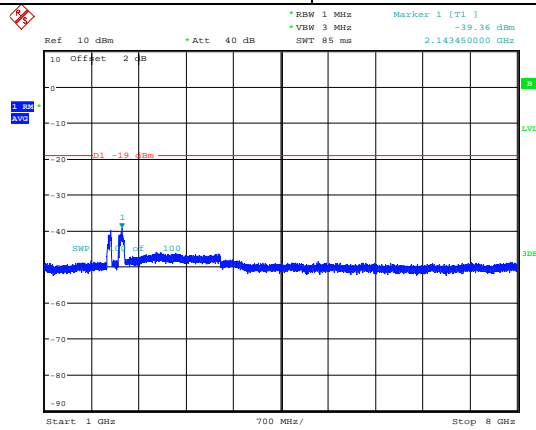

ProjectNo.:SSH1240116-03495E-RF Tester:Stu Song  
Date: 27.FEB.2024 14:54:20

Cellular Band

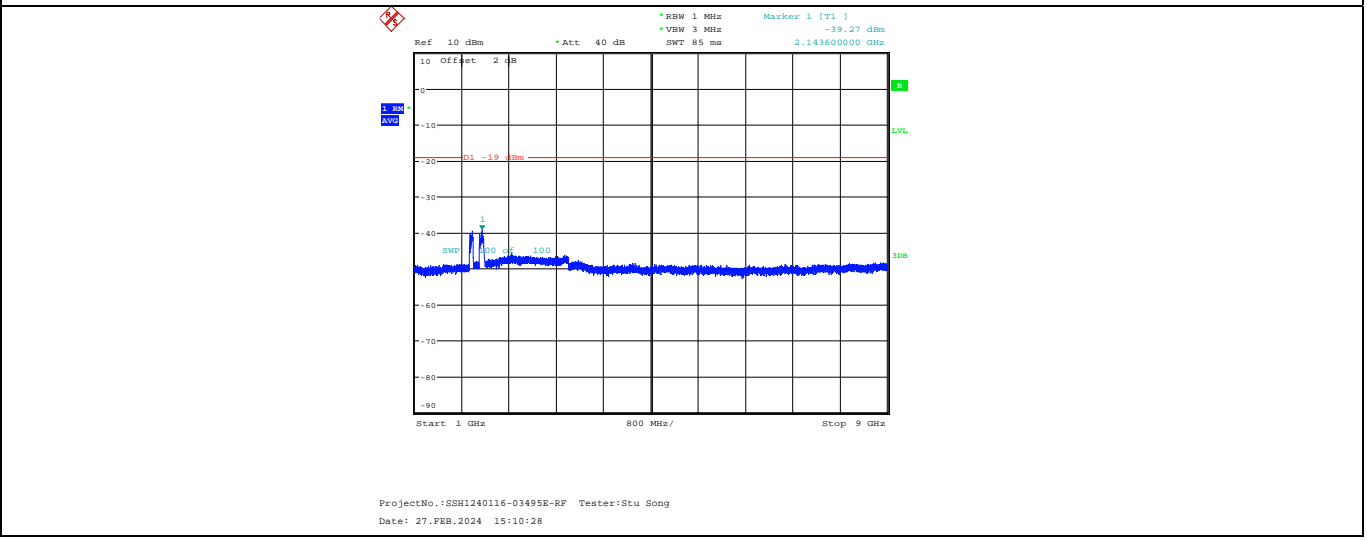
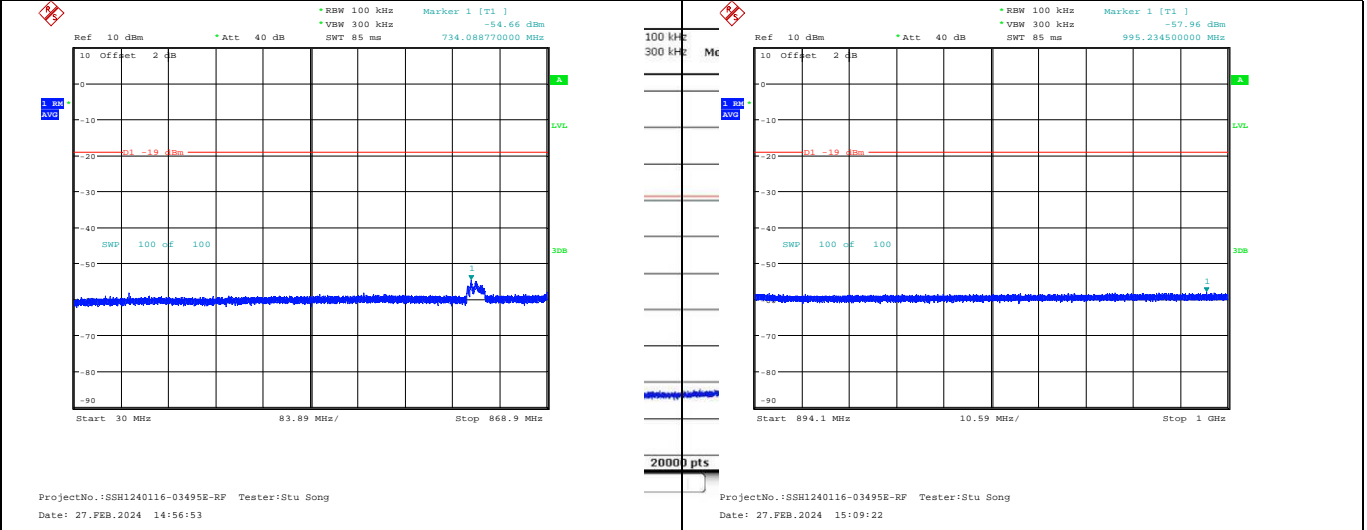

AWS-1 Band

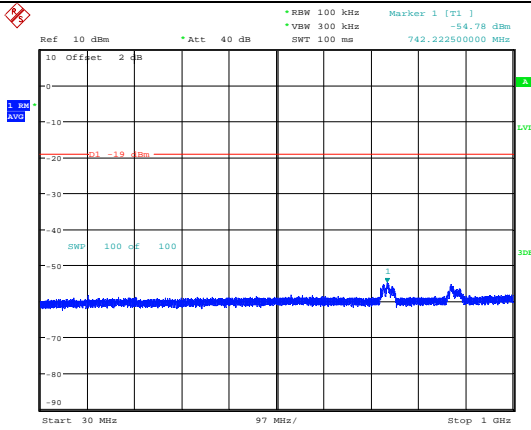

ProjectNo.:SSH1240116-03495E-RF Tester:Stu Song  
Date: 27.FEB.2024 15:13:04

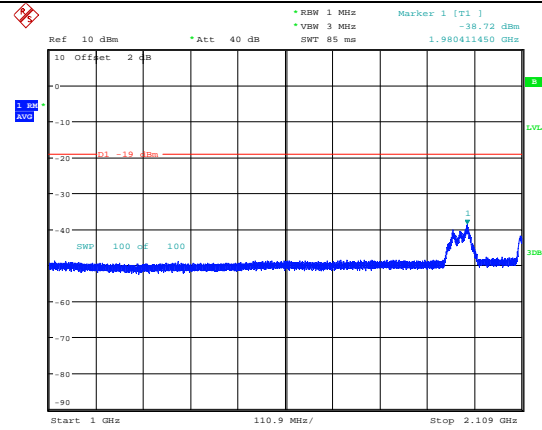

ProjectNo.:SSH1240116-03495E-RF Tester:Stu Song  
Date: 27.FEB.2024 15:14:35

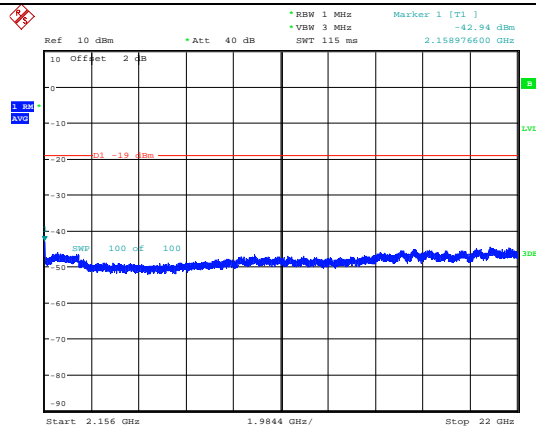

ProjectNo.:SSH1240116-03495E-RF Tester:Stu Song  
Date: 27.FEB.2024 15:15:57

PCS Band

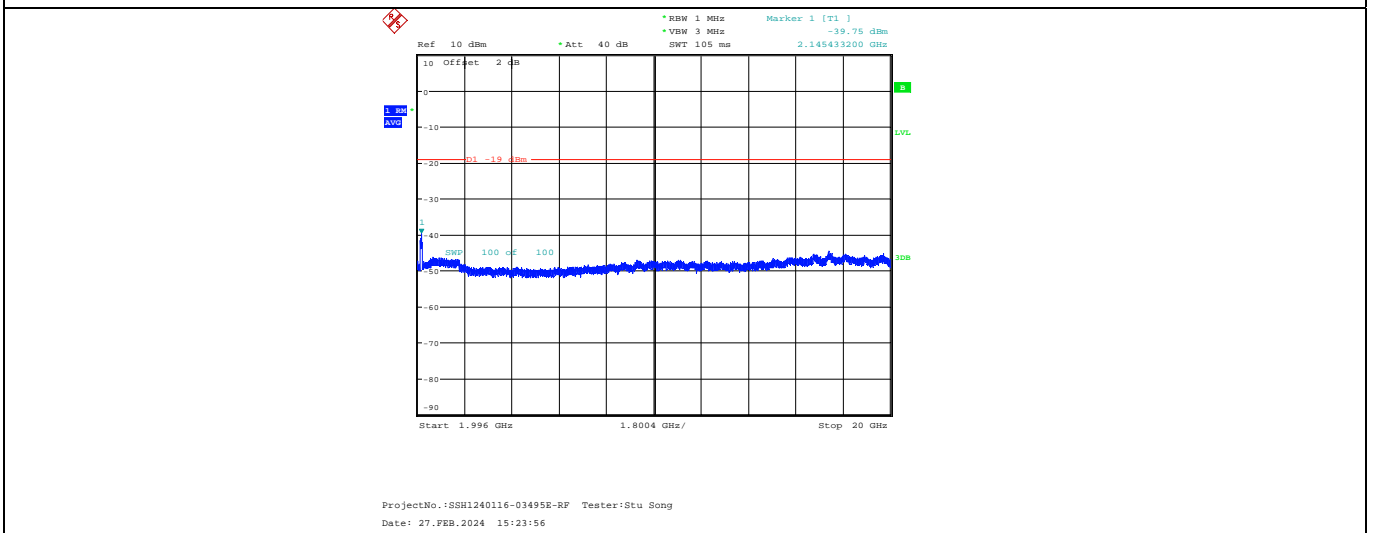
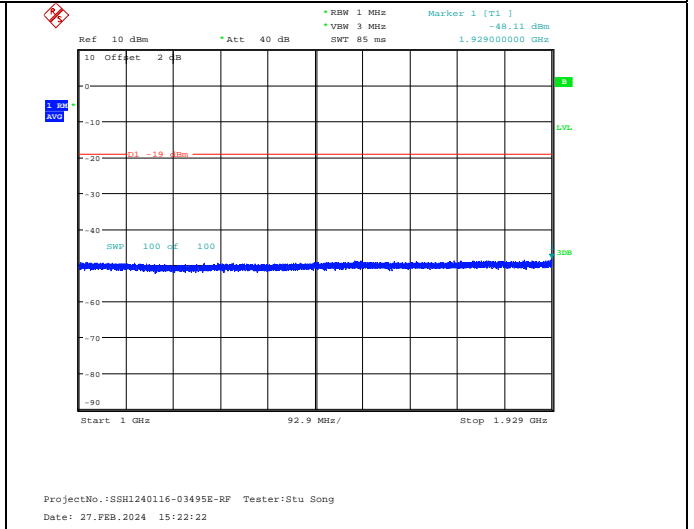
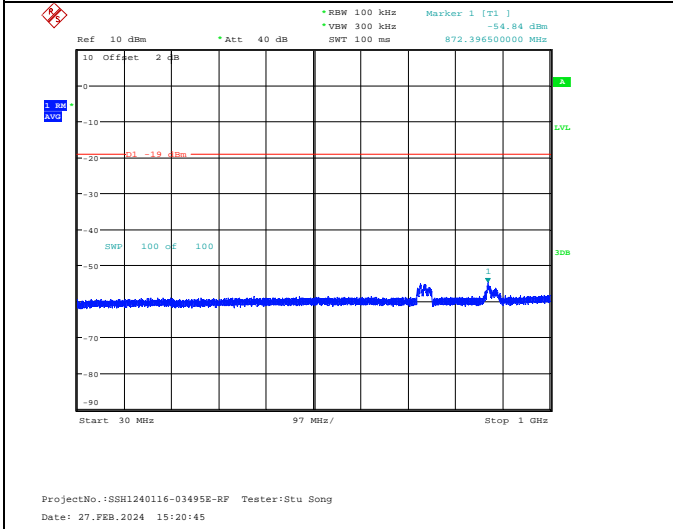

## 4.7 Noise Limits

### 4.7.1 Applicable Standard

According to § 20.21(e)(8)(i)(A) *Noise Limits*; § 20.21(e)(8)(i)(H) *Transmit Power Off Mode* (uplink and downlink noise power); §20.21(e)(4) *Self-monitoring*.

### 4.7.2 Test Procedure

#### 4.7.3 Maximum transmitter noise power level

KDB 935210 D03 Signal Booster Measurements v04r04 Clause 7.7.1

- a) Connect the EUT to the test equipment as shown in **Figure 3**. Begin with the uplink output (donor) port connected to the spectrum analyzer. When measuring downlink noise, connect the downlink output (server) port to the spectrum analyzer.
- b) Set the spectrum analyzer RBW to 1 MHz with the  $VBW \geq 3 * RBW$ .
- c) Select the power averaging (rms) detector and trace average over at least 100 traces.
- d) Set the center frequency of the spectrum analyzer to the center of the CMRS band under test with the span  $\geq 2$  the CMRS band.
- e) Measure the maximum transmitter noise power level.
- f) Save the spectrum analyzer plot as necessary for inclusion in the final test report.
- g) Repeat 7.7b) to 7.7f) for all operational uplink and downlink bands.
- h) Connect the EUT to the test equipment as shown in Figure 4 for uplink noise power measurement in the presence a downlink signal. Affirm the coupled path of the RF coupler is connected to the spectrum analyzer.
- i) Configure the signal generator for AWGN operation with a 99% OBW of 4.1 MHz.
- j) Set the spectrum analyzer RBW for 1 MHz,  $VBW \geq 3*RBW$ , with a power averaging (rms) detector with at least 100 trace averages.
- k) Set the center frequency of the spectrum analyzer to the center of the CMRS band under test, with the span  $\geq 2*$ the CMRS band. This shall include all spectrum blocks in the particular CMRS band under test (see Appendix A).
- l) For uplink noise measurements, set the spectrum analyzer center frequency for the uplink band under test, and tune the signal generator to the center of the paired downlink band.
- m) Measure the maximum transmitter noise power level while varying the downlink signal generator output level from  $-90$  dBm to  $-20$  dBm, as measured at the input port (i.e., downlink signal level at the booster donor port node of Figure 4), in 1 dB steps inside the RSSI-dependent region, and in 10 dB steps outside the RSSI-dependent region. Report the six values closest to the limit, with at least two points within the RSSI-dependent region of the limit. See Appendix D for noise limits graphs.
- n) Repeat 7.7.1h) through 7.7.1m) for all operational uplink bands.

*NOTE—Some signal boosters will require a signal generator input because they will not operate unless a signal is received at the input terminals. If this is the case, for the setups shown in Figure 3 and Figure 4 connect a second signal generator at the server port, then cycle the RF output of the second signal generator to simulate this function.*

*NOTE—Some signal boosters have a maximum transmitter noise power level that is less than the Transmit Power Off Mode of  $-70$  dBm. For these boosters it is still necessary to confirm that the uplink noise power limits are met in the presence of a downlink signal. Test reports should show measurement data demonstrating compliance. Alternatively the applicant may provide attestation with detailed design information and explanation justifying the omission of the variable uplink testing.*

#### 4.7.4 Variable uplink noise timing

KDB 935210 D03 Signal Booster Measurements v04r04 Clause 7.7.2

Variable uplink noise timing is to be measured as follows, using the test setup shown in **Figure 4**.

- a) Set the spectrum analyzer to the uplink frequency to be measured.
- b) Set the span to 0 Hz, with a sweep time of 10 seconds.
- c) Set the power level of signal generator to the lowest level of the RSSI-dependent noise [see 7.7.1m)].
- d) Select MAX HOLD and increase the power level of signal generator by 10 dB for mobile boosters, and 20 dB for fixed boosters.
- e) Confirm that the uplink noise decreases to the specified level within 1 second for mobile devices, and within 3 seconds for fixed devices.<sup>18</sup>
- f) Repeat 7.7.2a) to 7.7.2e) for all operational uplink bands.
- g) Include plots and summary table in test report.

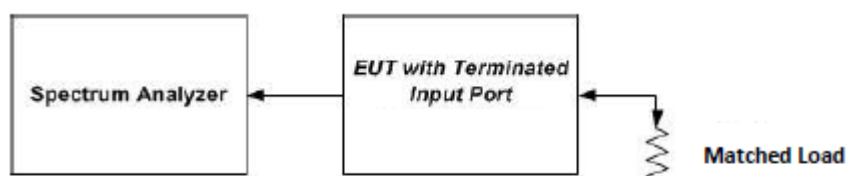

Figure 3 – Noise limit test setup (also used for 7.8)

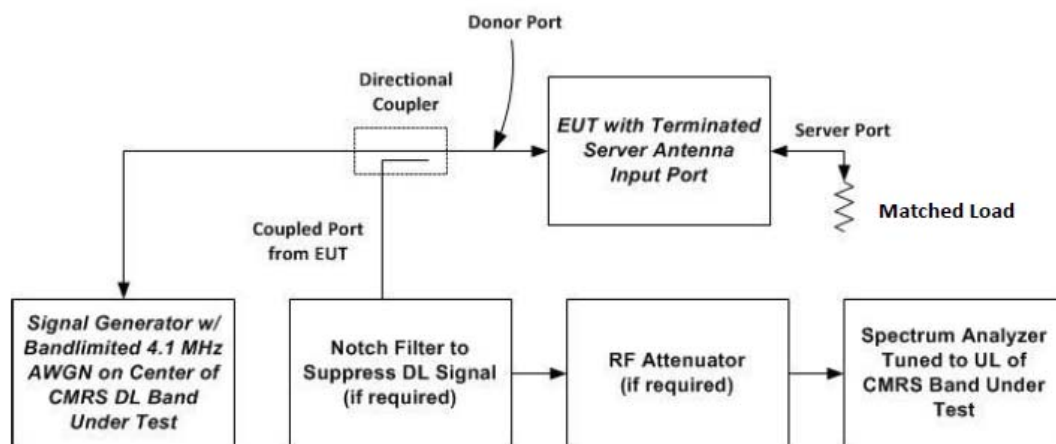

Figure 4 – Test setup for uplink noise power measurement in the presence of a downlink signal



**4.7.5 Test Result**

Serial Number:	2G05-5	Test Date:	2024/2/27~2024/2/28
Test Site:	RF	Test Mode:	Transmitting
Tester:	Stu Song	Test Result:	Pass

**Environmental Conditions:**

Temperature: (°C)	20.5~21.6	Relative Humidity: (%)	38~39	ATM Pressure: (kPa)	101.8~102.1
----------------------	-----------	---------------------------	-------	------------------------	-------------

**Test Equipment List and Details:**

Manufacturer	Description	Model	Serial Number	Calibration Date	Calibration Due Date
R&S	Spectrum Analyzer	FSU 26	200160/026	2023/10/18	2024/10/17
yzjingcheng	Coaxial Cable	KTRFBU-141-50	41010012	2023/9/1	2024/8/31
yzjingcheng	Coaxial Cable	KTRFBU-141-50	41010013	2023/9/1	2024/8/31
Eastsheep	Coaxial Attenuator	5W-N-JK-6G-10dB	F-08-EM502	2023/9/10	2024/9/9
Agilent	MXG Vector Signal Generator	N5182B	MY51350142	2023/9/1	2024/8/31

*\* Statement of Traceability: Bay Area Compliance Laboratories Corp. (Dongguan) attests that all calibrations have been performed, traceable to National Primary Standards and International System of Units (SI).*

**Test Data:**

**Maximum Transmitter Noise Power Level**

Operation Band	Uplink Noise (dBm/MHz)	Downlink Noise (dBm/MHz)	Limit (dBm/MHz)
Lower 700MHz	-48.07	-47.22	-45.51
Upper 700MHz	-48.75	-47.24	-44.64
Cellular	-49.97	-46.23	-44.05
AWS-1	-45.84	-39.83	-37.73
PCS	-39.80	-39.70	-37.01

Note: Fixed booster maximum noise power shall not exceed  $-102.5 \text{ dBm/MHz} + 20 \text{ Log}_{10}(\text{Frequency})$ , where Frequency is the uplink mid-band frequency of the supported spectrum bands in MHz.

Lower 700M Band-Uplink

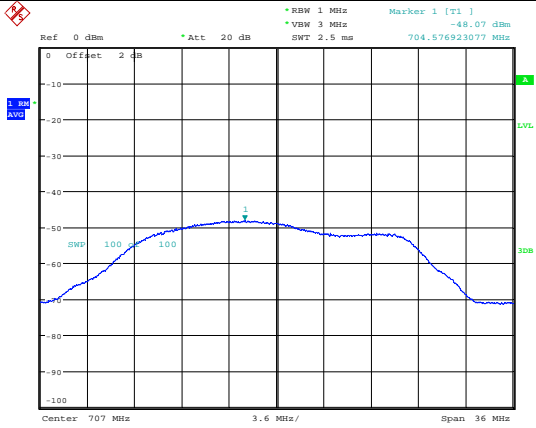

ProjectNo.:SSH1240116-03495E-RF Tester:Stu Song  
 Date: 27.FEB.2024 16:57:36

Lower 700M Band-Downlink

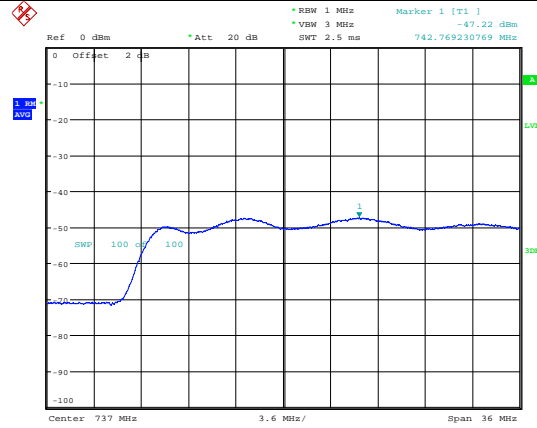

ProjectNo.:SSH1240116-03495E-RF Tester:Stu Song  
 Date: 27.FEB.2024 17:06:09

Upper 700M Band-Uplink

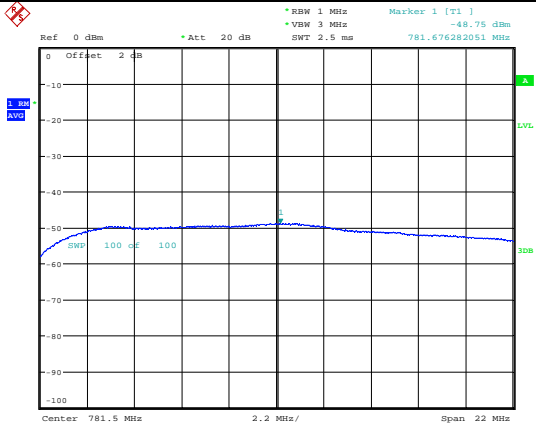

ProjectNo.:SSH1240116-03495E-RF Tester:Stu Song  
 Date: 27.FEB.2024 16:59:17

Upper 700M Band-Downlink

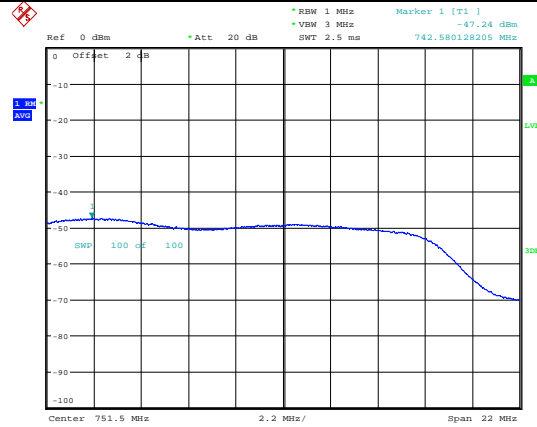

ProjectNo.:SSH1240116-03495E-RF Tester:Stu Song  
 Date: 27.FEB.2024 17:07:05

Cellular Band-Uplink

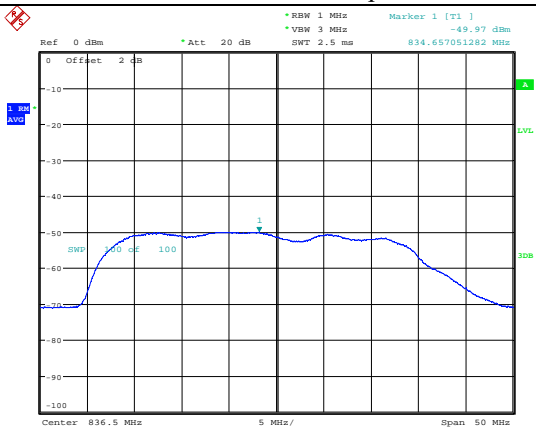

ProjectNo.:SSH1240116-03495E-RF Tester:Stu Song  
 Date: 27.FEB.2024 17:00:52

Cellular Band-Downlink

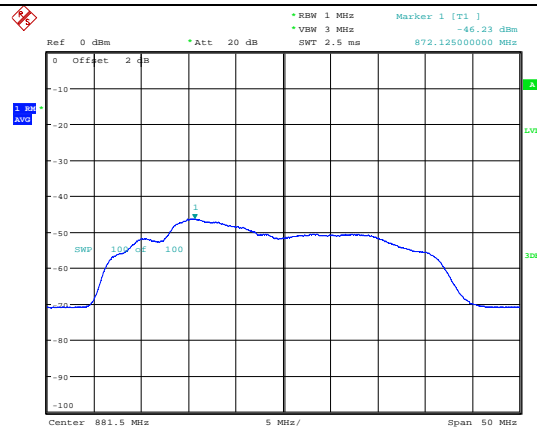

ProjectNo.:SSH1240116-03495E-RF Tester:Stu Song  
 Date: 27.FEB.2024 17:07:55

**AWS-1 Band-Uplink**

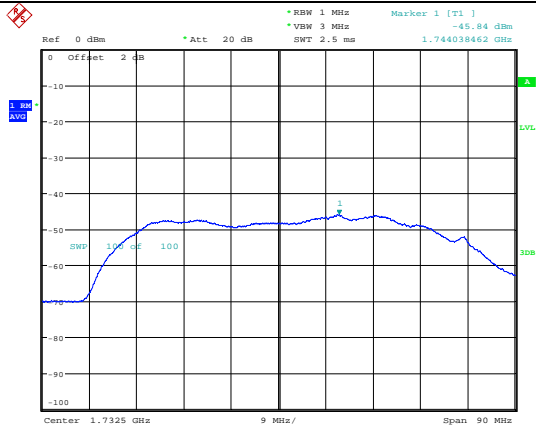

ProjectNo.:SSH1240116-03495E-RF Tester:Stu Song  
 Date: 27.FEB.2024 17:02:01

**AWS-1 Band-Downlink**

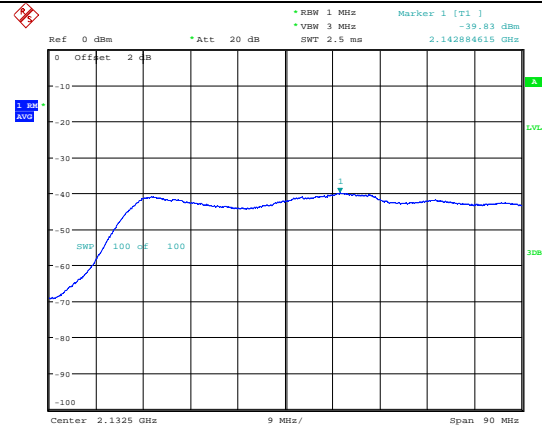

ProjectNo.:SSH1240116-03495E-RF Tester:Stu Song  
 Date: 28.FEB.2024 08:03:52

**PCS Band-Uplink**

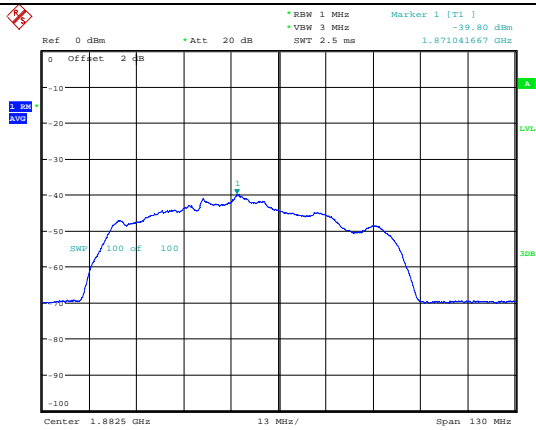

ProjectNo.:SSH1240116-03495E-RF Tester:Stu Song  
 Date: 28.FEB.2024 08:00:58

**PCS Band-Downlink**

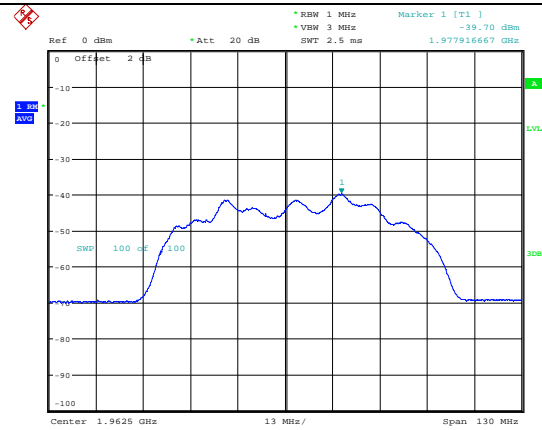

ProjectNo.:SSH1240116-03495E-RF Tester:Stu Song  
 Date: 27.FEB.2024 17:09:53

**Variable Uplink Noise Limit:**

<b>Lower 700MHz Band</b>			
<b>RSSI</b>	<b>Noise</b>	<b>Limit</b>	<b>Margin</b>
<b>dBm</b>	<b>dBm</b>	<b>dBm</b>	<b>dB</b>
-90.00	-49.45	-45.51	3.94
-80.00	-49.38	-45.51	3.87
-70.00	-49.22	-45.51	3.71
-60.00	-72.53	-45.51	27.02
-57.49	-72.68	-45.51	27.17
-51.00	-72.71	-52.00	20.71
-45.00	-72.67	-58.00	14.67
-39.00	-72.70	-64.00	8.70
-33.00	-72.65	-70.00	2.65
-30.00	-72.72	-70.00	2.72
-20.00	-72.74	-70.00	2.74
-10.00	-72.67	-70.00	2.67

<b>Upper 700MHz Band</b>			
<b>RSSI</b>	<b>Noise</b>	<b>Limit</b>	<b>Margin</b>
<b>dBm</b>	<b>dBm</b>	<b>dBm</b>	<b>dB</b>
-90.00	-50.24	-44.64	5.60
-80.00	-50.03	-44.64	5.39
-70.00	-50.21	-44.64	5.57
-60.00	-54.75	-44.64	10.11
-58.36	-72.58	-44.64	27.94
-52.00	-72.64	-51.00	21.64
-46.00	-72.67	-57.00	15.67
-40.00	-72.65	-63.00	9.65
-33.00	-72.68	-70.00	2.68
-30.00	-72.63	-70.00	2.63
-20.00	-72.58	-70.00	2.58
-10.00	-72.51	-70.00	2.51

<b>Cellular</b>			
<b>RSSI</b>	<b>Noise</b>	<b>Limit</b>	<b>Margin</b>
<b>dBm</b>	<b>dBm</b>	<b>dBm</b>	<b>dB</b>
-90.00	-51.46	-44.05	7.41
-80.00	-51.51	-44.05	7.46
-70.00	-51.58	-44.05	7.53
-60.00	-52.74	-44.05	8.69
-58.95	-53.46	-44.05	9.41
-51.00	-72.69	-52.00	20.69
-45.00	-72.65	-58.00	14.65
-39.00	-72.68	-64.00	8.68
-33.00	-72.71	-70.00	2.71
-30.00	-72.64	-70.00	2.64
-20.00	-72.67	-70.00	2.67
-10.00	-72.65	-70.00	2.65

AWS-1			
RSSI	Noise	Limit	Margin
dBm	dBm	dBm	dB
-90.00	-47.69	-37.73	9.96
-80.00	-47.46	-37.73	9.73
-70.00	-47.35	-37.73	9.62
-65.27	-47.72	-37.73	9.99
-57.00	-51.65	-46.00	5.65
-49.00	-72.14	-54.00	18.14
-41.00	-72.09	-62.00	10.09
-33.00	-72.03	-70.00	2.03
-30.00	-72.12	-70.00	2.12
-20.00	-72.06	-70.00	2.06
-10.00	-72.15	-70.00	2.15

PCS			
RSSI	Noise	Limit	Margin
dBm	dBm	dBm	dB
-90.00	-41.54	-37.01	4.53
-80.00	-41.42	-37.01	4.41
-70.00	-42.35	-37.01	5.34
-65.99	-43.16	-37.01	6.15
-57.00	-71.98	-46.00	25.98
-49.00	-71.91	-54.00	17.91
-41.00	-71.96	-62.00	9.96
-33.00	-71.95	-70.00	1.95
-30.00	-71.88	-70.00	1.88
-20.00	-71.92	-70.00	1.92
-10.00	-71.86	-70.00	1.86

Note:

According to KDB 935210 D03 Signal Booster Measurements v04r04 Annex D, the Variable uplink Noise limit is  $-103 \text{ dBm/MHz} - \text{RSSI}$  in RSSI-Dependent Region, out of RSSI-Dependent Region, it is  $-102.5 \text{ dBm/MHz} + 20 * \text{Log}_{10}(\text{Frequency})$ , where Frequency is the uplink mid-band frequency of the supported spectrum bands in MHz..

**Variable Uplink Noise Timing:**

<b>Operating Band</b>	<b>Measured Value (s)</b>	<b>Limit (s)</b>
Lower 700MHz	0.022	3
Upper 700MHz	0.022	3
Cellular	0.022	3
AWS-1	0.022	3
PCS	0.017	3

Lower 700MHz Band

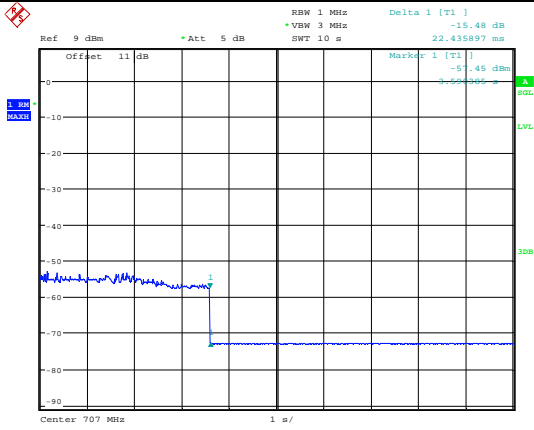

ProjectNo.:SSH1240116-03495E-RF Tester:Stu Song  
Date: 28.FEB.2024 11:21:30

Upper 700MHz Band

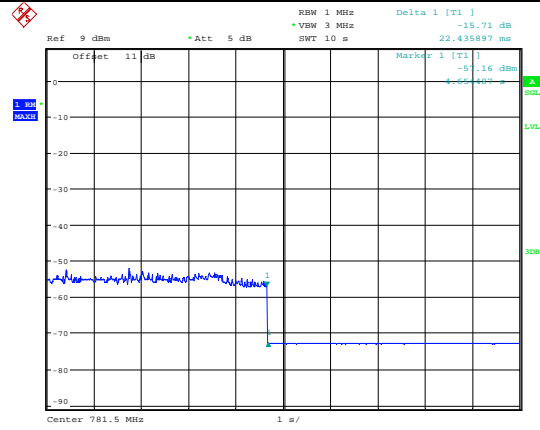

ProjectNo.:SSH1240116-03495E-RF Tester:Stu Song  
Date: 28.FEB.2024 11:25:00

Cellular Band

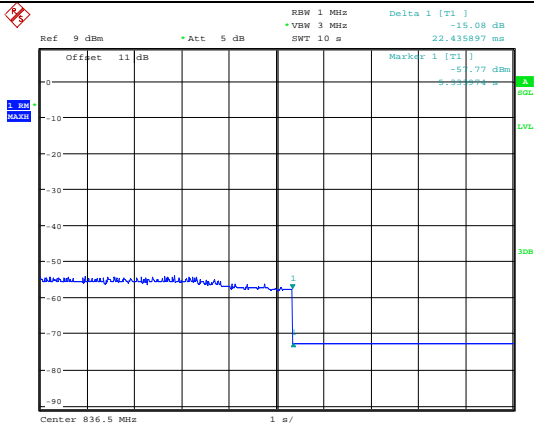

ProjectNo.:SSH1240116-03495E-RF Tester:Stu Song  
Date: 28.FEB.2024 11:30:31

AWS-1 Band

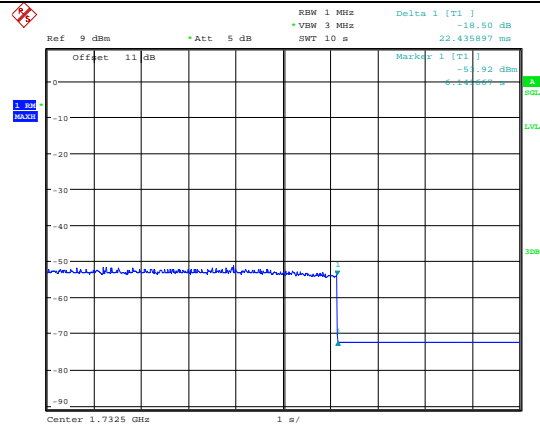

ProjectNo.:SSH1240116-03495E-RF Tester:Stu Song  
Date: 28.FEB.2024 11:32:29

PCS Band

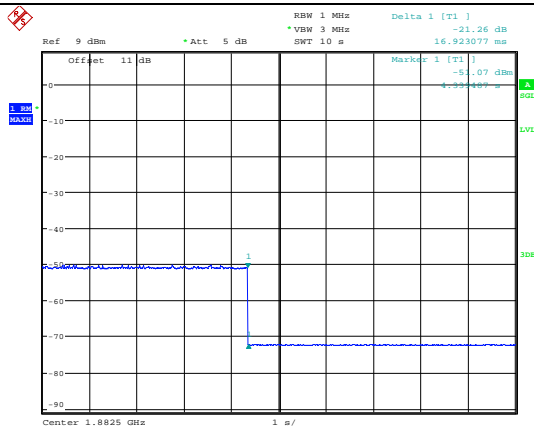

ProjectNo.:SSH1240116-03495E-RF Tester:Stu Song  
Date: 28.FEB.2024 11:36:20

## 4.8 Uplink Inactivity

### 4.8.1 Applicable Standard

According to § 20.21(e)(8)(i)(I) *Uplink Inactivity* & § 20.21(e)(4); § 20.21(e)(4) *Self-monitoring*.

### 4.8.2 Test Procedure

KDB 935210 D03 Signal Booster Measurements v04r04 Clause 7.8

This measurement procedure is intended to demonstrate compliance to the uplink inactivity requirements specified for wideband consumer signal boosters in Section 20.21(e)(8)(i)(I).

a) Connect the EUT to the test equipment as shown in **Figure 3** with the uplink output (donor) port connected to the spectrum analyzer.

*NOTE—Some signal boosters will require a signal generator input because they will not operate unless a signal is received at the input terminals. If this is the case for the setup shown in Figure 3 connect a signal generator at the server port, then cycle the RF output of the signal generator to simulate this function.*

b) Select the power averaging (rms) detector.

c) Set the spectrum analyzer RBW for 1 MHz with the VBW  $\geq 3 \times$  RBW.

d) Set the center frequency of the spectrum analyzer to the center of the uplink operational band.

e) Set the span for 0 Hz with a single sweep time for a minimum of 330 seconds.

f) Start to capture a new trace using MAX HOLD.

g) After approximately 15 seconds, turn on the EUT power.

h) After the full spectrum analyzer trace is complete, place a MARKER on the leading edge of the pulse, then use the DELTA MARKER METHOD to measure the time until the uplink becomes inactive.

i) Affirm that the noise level is below the uplink inactivity noise power limit, as specified by the rules.

j) Capture the plot for inclusion in the test report.

k) Measure noise using procedures in 7.7.1a) to 7.7.1f).

l) Repeat 7.8d) through 7.8k) for all operational uplink bands.

*NOTE—Some signal boosters have a maximum transmitter noise power level that is less than the uplink inactivity limit. For these boosters it is still necessary to confirm the uplink activity timing requirement. Test reports should show measurement data demonstrating compliance. Alternatively the applicant may provide attestation with detailed design information and explanation justifying the omission of the uplink inactivity test procedure.*

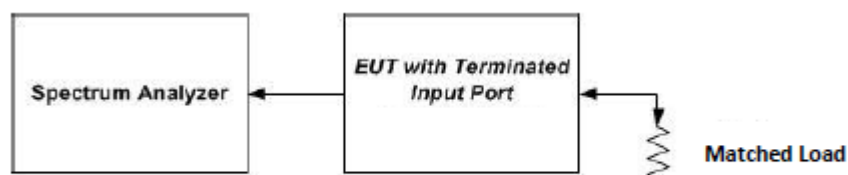

**Figure 3 – Noise limit test setup (also used for 7.8)**



**4.8.3 Test Result**

Serial Number:	2G05-5	Test Date:	2024/2/28
Test Site:	RF	Test Mode:	Transmitting
Tester:	Stu Song	Test Result:	Pass

**Environmental Conditions:**

Temperature: (°C)	21.6	Relative Humidity: (%)	39	ATM Pressure: (kPa)	102.1
----------------------	------	---------------------------	----	------------------------	-------

**Test Equipment List and Details:**

Manufacturer	Description	Model	Serial Number	Calibration Date	Calibration Due Date
R&S	Spectrum Analyzer	FSU 26	200160/026	2023/10/18	2024/10/17
yzjingcheng	Coaxial Cable	KTRFBU-141-50	41010012	2023/9/1	2024/8/31
yzjingcheng	Coaxial Cable	KTRFBU-141-50	41010013	2023/9/1	2024/8/31
Eastsheep	Coaxial Attenuator	5W-N-JK-6G-10dB	F-08-EM502	2023/9/10	2024/9/9
Agilent	MXG Vector Signal Generator	N5182B	MY51350142	2023/9/1	2024/8/31

*\* Statement of Traceability: Bay Area Compliance Laboratories Corp. (Dongguan) attests that all calibrations have been performed, traceable to National Primary Standards and International System of Units (SI).*

**Test Data:**

Operation Band	Measured value (s)	Limit (s)
Lower 700MHz	275.73	300
Upper 700MHz	275.73	
Cellular	275.73	
AWS-1	275.73	
PCS	275.73	

Note: When the consumer booster is not serving an active device connection after 5 minutes the uplink noise power not exceed -70 dBm/MHz.

Lower 700MHz Band

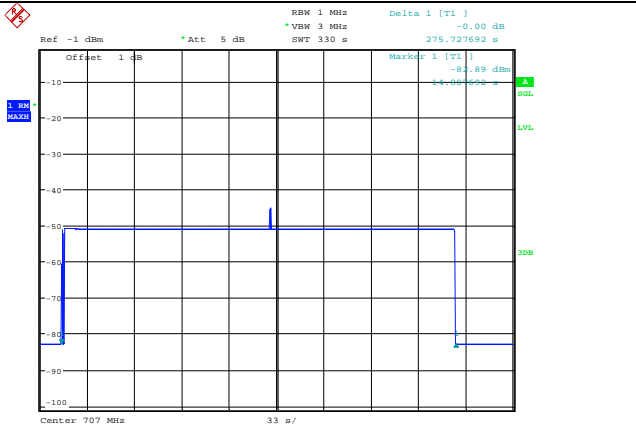

ProjectNo.:SSH1240116-03495E-RF Tester:Stu Song  
 Date: 28.FEB.2024 13:46:33

Upper 700MHz Band

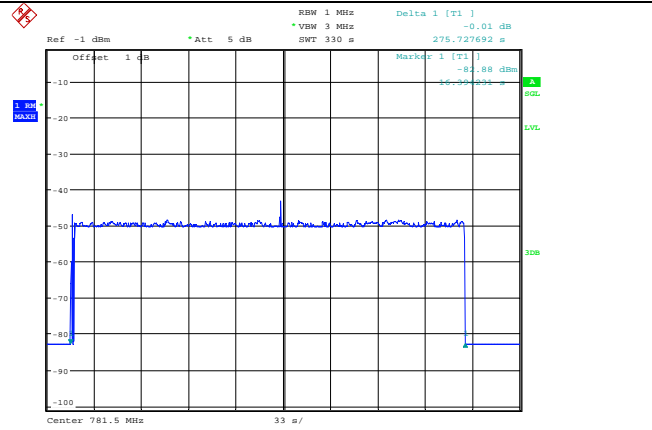

ProjectNo.:SSH1240116-03495E-RF Tester:Stu Song  
 Date: 28.FEB.2024 12:46:21

Cellular Band

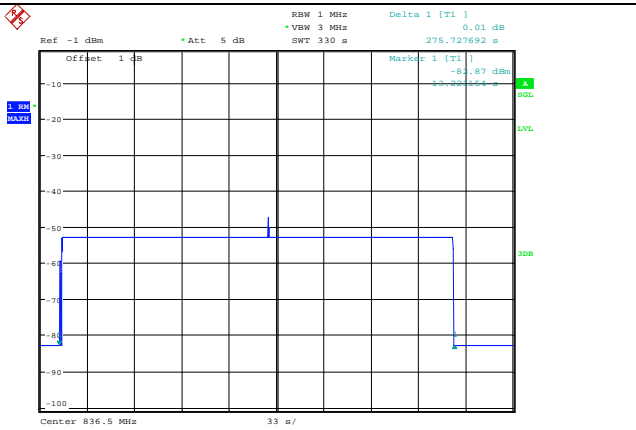

ProjectNo.:SSH1240116-03495E-RF Tester:Stu Song  
 Date: 28.FEB.2024 12:52:29

AWS-1 Band

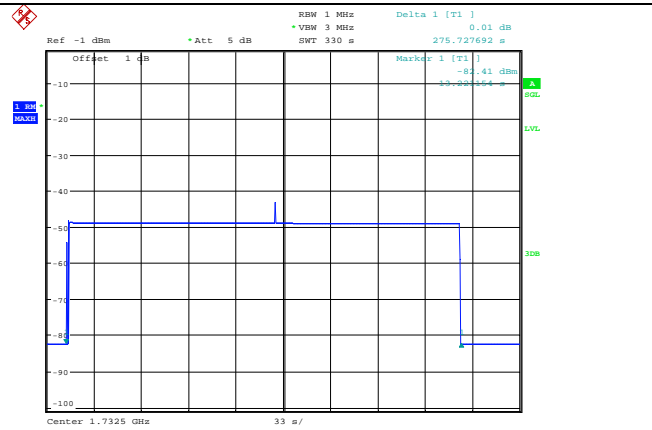

ProjectNo.:SSH1240116-03495E-RF Tester:Stu Song  
 Date: 28.FEB.2024 12:59:41

PCS Band

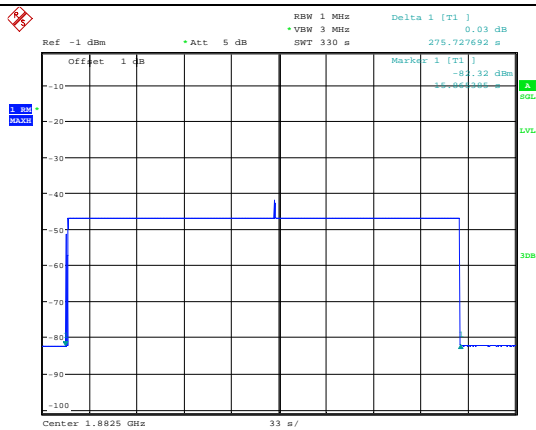

ProjectNo.:SSH1240116-03495E-RF Tester:Stu Song  
 Date: 28.FEB.2024 13:06:16

## 4.9 Variable Booster Gain

### 4.9.1 Applicable Standard

According to § 20.21(e)(8)(i)(C)(1) *Booster Gain Limits* (variable gain); § 20.21(e)(8)(i)(H) *Transmit Power Off Mode* (uplink gain).

### 4.9.2 Test Procedure

#### Maximum gain

This procedure shall be used to demonstrate compliance to the booster gain limits specified for wideband consumer signal boosters in Section 20.21(e)(8)(i)(C) or Section 20.21(e)(8)(i)(H). The variable booster gain limits are expressed as a function of RSSI and MSCL, and are shown graphically in Appendix D. The RSSI is varied over a range of values as specified within the procedure. Refer to Appendix B of this document for guidance on determining the applicable MSCL value.

- a) Connect the EUT to the test equipment as shown in **Figure 5** with the uplink output (donor) port connected to signal generator #1. Affirm that the coupled path of the RF coupler is connected to the spectrum analyzer.
- b) Configure downlink signal generator #1 for AWGN operation with a 99% OBW of 4.1 MHz, tuned to the center of the operational band.
- c) Set the power level and frequency of signal generator #2 to a value that is 5 dB below the AGC level determined from 7.2. The signal type is AWGN with a 99% OBW of 4.1 MHz.
- d) Set RBW = 100 kHz.
- e) Set VBW  $\geq$  300 kHz.
- f) Select the CHANNEL POWER measurement mode.
- g) Select the power averaging (rms) detector.
- h) Affirm that the number of measurement points per sweep  $\geq (2*\text{span})/\text{RBW}$ .
- i) Sweep time = auto couple or as necessary (but no less than auto couple value).
- j) Trace average at least 10 traces in power averaging (i.e., rms) mode.
- k) Measure the maximum channel power and compute maximum gain when varying the signal generator #1 output to a level from -90 dBm to -20 dBm, as measured at the input port (i.e., downlink signal level at the booster donor port node of Figure 5), in 1 dB steps inside the RSSI-dependent region, and 10 dB steps outside the RSSI-dependent region. Report the six values closest to the limit, including at least two points from within the RSSI-dependent region of operation. See gain limit in charts in Appendix D for uplink gain requirements. Additionally, document that the EUT provides equivalent uplink and downlink gain, and when operating in shutoff mode that the uplink and downlink gain is within the transmit power off mode gain limits.
- l) Repeat 7.9.1b) to 7.9.1k) for all operational uplink bands.

#### Variable uplink gain timing

Variable uplink gain timing is to be measured as follows, using the test setup shown in **Figure 5**.

- a) Set the spectrum analyzer to the uplink frequency to be measured.
- b) Set the span to 0 Hz with a sweep time of 10 seconds.
- c) Set the power level of signal generator #1 to the lowest level of the RSSI-dependent gain [see 7.9.1k)].
- d) Select MAX HOLD and increase the power level of signal generator #1 by 10 dB for mobile boosters, and by 20 dB for fixed indoor boosters. Signal generator #2 remains same, as described in 7.9.1c).
- e) Confirm that the uplink gain decreases to the specified levels, within 1 second for mobile devices,

and within 3 seconds for fixed devices.19  
f) Repeat 7.9.2a) to 7.9.2e) for all operational uplink bands.

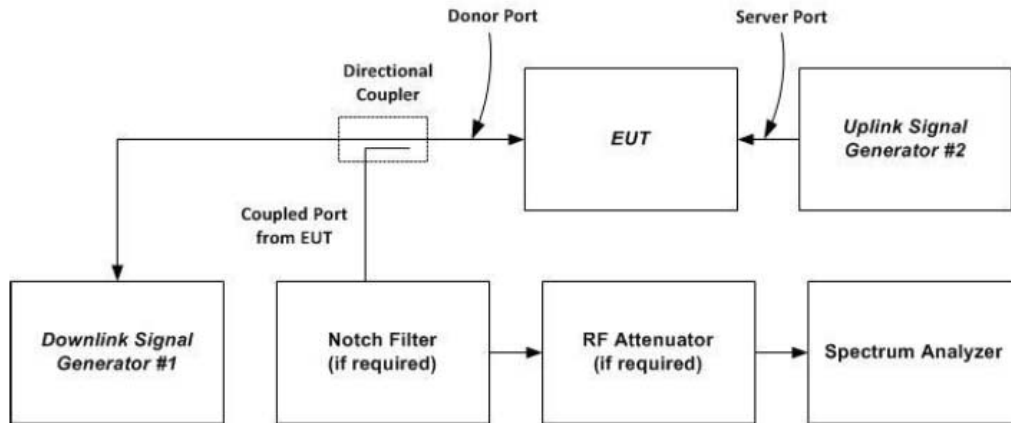

Figure 5 – Variable gain instrumentation test setup

**4.9.3 Test Result**

Serial Number:	2G05-5	Test Date:	2024/2/28
Test Site:	RF	Test Mode:	Transmitting
Tester:	Stu Song	Test Result:	Pass

**Environmental Conditions:**

Temperature: (°C)	21.6	Relative Humidity: (%)	39	ATM Pressure: (kPa)	102.1
----------------------	------	---------------------------	----	------------------------	-------

**Test Equipment List and Details:**

Manufacturer	Description	Model	Serial Number	Calibration Date	Calibration Due Date
R&S	Spectrum Analyzer	FSU 26	200160/026	2023/10/18	2024/10/17
yzjingcheng	Coaxial Cable	KTRFBU-141-50	41010012	2023/9/1	2024/8/31
yzjingcheng	Coaxial Cable	KTRFBU-141-50	41010013	2023/9/1	2024/8/31
Eastsheep	Coaxial Attenuator	5W-N-JK-6G-10dB	F-08-EM502	2023/9/10	2024/9/9
Eastsheep	Coaxial Attenuator	5W-N-JK-6G-10dB	F-08-EM503	2023/9/10	2024/9/9
Agilent	MXG Vector Signal Generator	N5182B	MY51350142	2023/9/1	2024/8/31
R&S	Wideband Radio Communication Tester	CMW500	110479	2023/10/18	2024/10/17

\* Statement of Traceability: Bay Area Compliance Laboratories Corp. (Dongguan) attests that all calibrations have been performed, traceable to National Primary Standards and International System of Units (SI).

**Test Data:**

**MSCL Calculation:**

Operation Bands	Frequency (MHz)	Minimum Separation Distance (m)	Path Loss (dB)	Inside Cable Loss (dB)	Inside Antenna Gain (dBi)	MSCL
Lower 700MHz	707	1	35.51	0.00	5.57	23.92
Upper 700MHz	781.5	1	36.38	0.00	5.79	24.57
Cellular	836.5	1	36.97	0.00	5.91	25.04
AWS-1	1732.5	1	43.29	0.00	7.61	29.66
PCS	1882.5	1	44.02	0.00	6.91	31.08

Note:

1. Path loss =  $20\log f + 20\log d - 27.5$  (dB)

f = frequency is the uplink mid-band frequency of the supported spectrum bands in MHz

d = minimum separation distance between the mobile device and booster server antenna

2. MSCL = Path loss + Indoor Cable Loss - Mobile Antenna Gain (0dBi) - Indoor Antenna Gain

The Inside Cable Loss was including in the inside Antenna Gain;

The Minimum MSCL was calculated and used according to the User Manual;

**Variable Booster Gain:**

Operation Bands	RSSI	P <sub>in</sub>	P <sub>out</sub>	Measured Value	MSCL	Limit	Margin
	dBm	dBm	dBm	dB	dB	dB	dB
Lower 700MHz	-90.00	-42.00	11.37	53.37	23.92	63.49	10.12
	-80.00	-42.00	11.25	53.25	23.92	63.49	10.24
	-68.08	-42.00	11.27	53.27	23.92	63.49	10.22
	-61.00	-42.00	5.04	47.04	23.92	50.92	3.88
	-60.00	-42.00	3.95	45.95	23.92	49.92	3.97
	-59.00	-42.00	-41.57	0.43	23.92	48.92	48.49
	-27.59	-42.00	-41.56	0.44	23.92	23.00	22.56
	-20.00	-42.00	-41.56	0.44	23.92	23.00	22.56
Upper 700MHz	-10.00	-42.00	-41.59	0.41	23.92	23.00	22.59
	-90.00	-39.00	12.32	51.32	24.57	64.36	13.04
	-80.00	-39.00	12.24	51.24	24.57	64.36	13.12
	-67.88	-39.00	12.28	51.28	24.57	64.36	13.08
	-59.00	-39.00	5.11	44.11	24.57	49.57	5.46
	-58.00	-39.00	-41.51	-2.51	24.57	48.57	51.08
	-57.00	-39.00	-41.54	-2.54	24.57	47.57	50.11
	-26.52	-39.00	-41.61	-2.61	24.57	23.00	25.61
Cellular	-20.00	-39.00	-41.59	-2.59	24.57	23.00	25.59
	-10.00	-39.00	-41.56	-2.56	24.57	23.00	25.56
	-90.00	-39.00	13.31	52.31	25.04	64.95	12.64
	-80.00	-39.00	13.25	52.25	25.04	64.95	12.70
	-67.78	-39.00	13.24	52.24	25.04	64.95	12.71
	-55.00	-39.00	6.91	45.91	25.04	46.04	0.13
	-54.00	-39.00	-41.58	-2.58	25.04	45.04	47.62
	-53.00	-39.00	-41.54	-2.54	25.04	44.04	46.58
AWS-1	-25.83	-39.00	-41.57	-2.57	25.04	23.00	25.57
	-20.00	-39.00	-41.55	-2.55	25.04	23.00	25.55
	-10.00	-39.00	-41.59	-2.59	25.04	23.00	25.59
	-90.00	-44.00	10.23	54.23	29.66	71.27	17.04
	-80.00	-44.00	10.16	54.16	29.66	71.27	17.11
	-69.28	-44.00	10.21	54.21	29.66	71.27	17.06
	-57.00	-44.00	4.85	48.85	29.66	52.66	3.81
	-56.00	-44.00	4.18	48.18	29.66	51.66	3.48
PCS	-55.00	-44.00	-41.49	2.51	29.66	50.66	48.15
	-21.01	-44.00	-41.55	2.45	29.66	23.00	20.55
	-10.00	-44.00	-41.52	2.48	29.66	23.00	20.52
	-90.00	-43.00	12.99	55.99	31.08	71.99	16.00
	-80.00	-43.00	12.94	55.94	31.08	71.99	16.05
	-68.87	-43.00	12.91	55.91	31.08	71.99	16.08
	-61.00	-43.00	5.97	48.97	31.08	58.08	9.11
	-60.00	-43.00	-41.34	1.66	31.08	57.08	55.42
PCS	-59.00	-43.00	-41.37	1.63	31.08	56.08	54.45
	-19.88	-43.00	-41.48	1.52	31.08	23.00	21.48
	-10.00	-43.00	-41.51	1.49	31.08	23.00	21.51

Note: According to KDB 935210 D03 Signal Booster Measurements v04r04 Annex D For Fixed Booster, Variable booster gain Limit: -34 dB - RSSI + MSCL.

**Variable Gain Timing:**

<b>Operation Band</b>	<b>Measured Value (s)</b>	<b>Limit (s)</b>
Lower 700MHz	0.984	3
Upper 700MHz	0.769	3
Cellular	0.785	3
AWS-1	0.962	3
PCS	0.769	3

Note: The uplink noise decreases to the specified level within 3 seconds for fixed devices.

Lower 700M Band

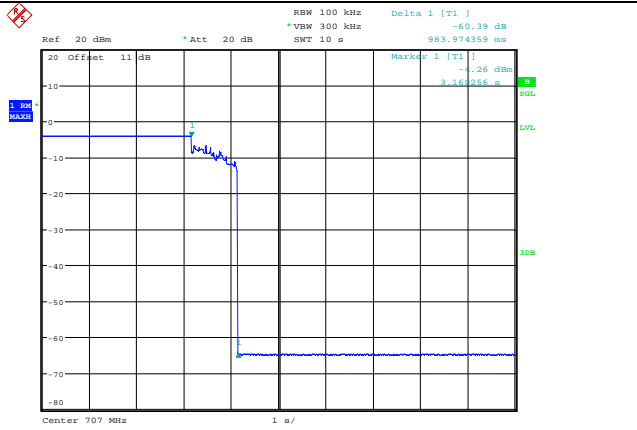

ProjectNo.:SSH1240116-03495E-RF Tester:Stu Song  
Date: 28.FEB.2024 19:51:48

Upper 700M Band

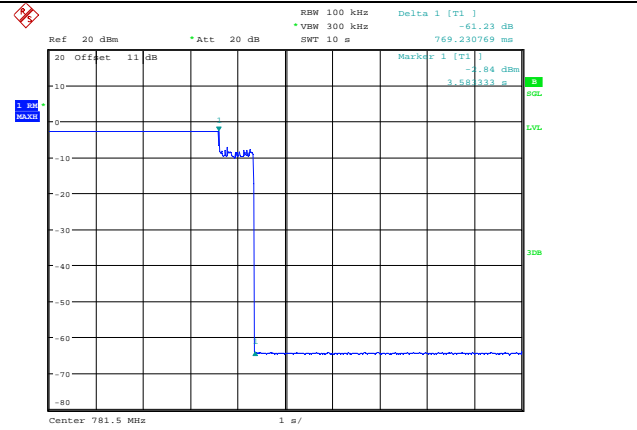

ProjectNo.:SSH1240116-03495E-RF Tester:Stu Song  
Date: 28.FEB.2024 19:58:13

Cellular Band

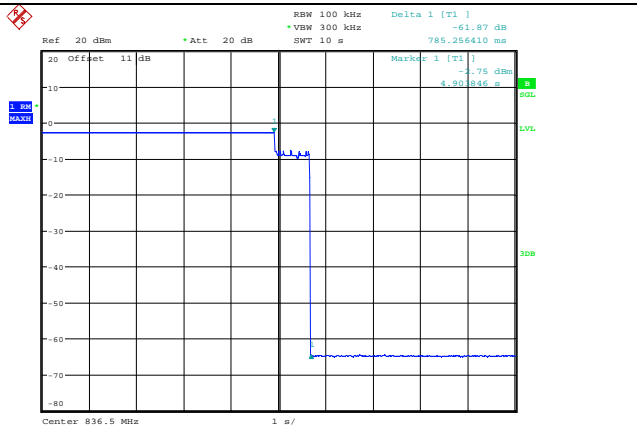

ProjectNo.:SSH1240116-03495E-RF Tester:Stu Song  
Date: 28.FEB.2024 20:02:55

AWS-1 Band

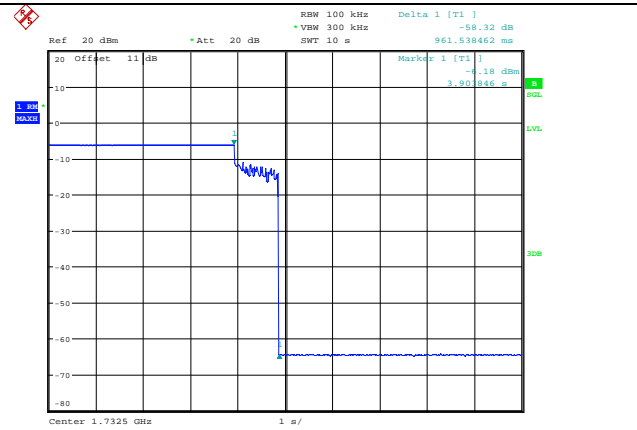

ProjectNo.:SSH1240116-03495E-RF Tester:Stu Song  
Date: 28.FEB.2024 20:05:09

PCS Band

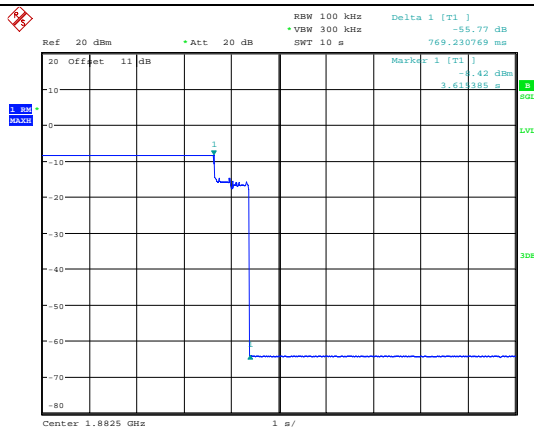

ProjectNo.:SSH1240116-03495E-RF Tester:Stu Song  
Date: 28.FEB.2024 20:07:44



## 4.10 Occupied Bandwidth

### 4.10.1 Applicable Standard

According to § 2.1049 *Measurements required: Occupied bandwidth.*

### 4.10.2 Test Procedure

This measurement is required to compare the consistency of the output signal relative to the input signal, and to satisfy the requirements of Section 2.1049.

- a) Connect the test equipment as shown in **Figure 6** to firstly measure the characteristics of the test signals produced by the signal generator.
- b) Set  $VBW \geq 3 \cdot RBW$ .
- c) Set the center frequency of the spectrum analyzer to the center of the operational band. The span will be adjusted for each modulation type and OBW as necessary for accurately viewing the signals.
- d) Set the signal generator for power level to match the values obtained from the tests of 7.2.
- e) Set the signal generator modulation type for GSM with a PRBS pattern and allow the trace on the signal generator to stabilize adjusting the span as necessary.
- f) Set the spectrum analyzer RBW for 1% to 5% of the EBW.
- g) Capture the spectrum analyzer trace for inclusion in the test report.
- h) Repeat 7.10c) to 7.10g) for CDMA and W-CDMA modulation, adjusting the span as necessary. AWGN or LTE may be used in place of W-CDMA, as an option.
- i) Repeat 7.10c) to 7.10h) for all uplink and downlink operational bands.
- j) Connect the test equipment as shown in Figure 1, with the uplink output (donor) port connected to the spectrum analyzer, and the server port connected to the signal generator.
- k) Repeat 7.10c) to 7.10i) with this EUT uplink path test setup.
- l) Connect the test equipment as shown in Figure 1, with the downlink output (server) port connected to the spectrum analyzer, and the donor port connected to the signal generator.
- m) Repeat 7.10c) to 7.10i) with this EUT downlink path test setup.

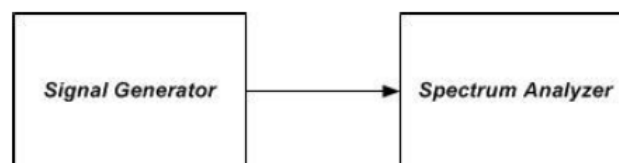

Figure 6 – Test setup for measuring characteristics of test signals used for subsequent EUT occupied bandwidth testing

**4.10.3 Test Result**

Serial Number:	2G05-5	Test Date:	2024/2/29
Test Site:	RF	Test Mode:	Transmitting
Tester:	Stu Song	Test Result:	Pass

**Environmental Conditions:**

Temperature: (°C)	22.6	Relative Humidity: (%)	58	ATM Pressure: (kPa)	101.1
----------------------	------	------------------------------	----	------------------------	-------

**Test Equipment List and Details:**

Manufacturer	Description	Model	Serial Number	Calibration Date	Calibration Due Date
R&S	Spectrum Analyzer	FSU 26	200160/026	2023/10/18	2024/10/17
yzjingcheng	Coaxial Cable	KTRFBU-141-50	41010012	2023/9/1	2024/8/31
yzjingcheng	Coaxial Cable	KTRFBU-141-50	41010013	2023/9/1	2024/8/31
Eastsheep	Coaxial Attenuator	5W-N-JK-6G-10dB	F-08-EM502	2023/9/10	2024/9/9
Agilent	MXG Vector Signal Generator	N5182B	MY51350142	2023/9/1	2024/8/31

*\* Statement of Traceability: Bay Area Compliance Laboratories Corp. (Dongguan) attests that all calibrations have been performed, traceable to National Primary Standards and International System of Units (SI).*

**Test Data:**

Mode	Operation Band	Signal Type	Input	Output
			MHz	MHz
Uplink	Lower 700MHz	GSM	0.245	0.245
		CDMA	1.279	1.279
		WCDMA	4.135	4.135
	Upper 700MHz	GSM	0.245	0.245
		CDMA	1.279	1.279
		WCDMA	4.135	4.135
	Cellular	GSM	0.245	0.245
		CDMA	1.279	1.279
		WCDMA	4.135	4.135
	AWS-1	GSM	0.245	0.245
		CDMA	1.279	1.279
		WCDMA	4.135	4.135
	PCS	GSM	0.245	0.245
		CDMA	1.279	1.284
		WCDMA	4.135	4.135
Downlink	Lower 700MHz	GSM	0.245	0.245
		CDMA	1.279	1.279
		WCDMA	4.167	4.167
	Upper 700MHz	GSM	0.245	0.245
		CDMA	1.279	1.279
		WCDMA	4.135	4.135
	Cellular	GSM	0.245	0.245
		CDMA	1.279	1.298
		WCDMA	4.135	4.199
	AWS-1	GSM	0.245	0.245
		CDMA	1.279	1.279
		WCDMA	4.167	4.135
	PCS	GSM	0.245	0.245
		CDMA	1.279	1.279
		WCDMA	4.135	4.135

**Uplink:  
Lower 700M Band**

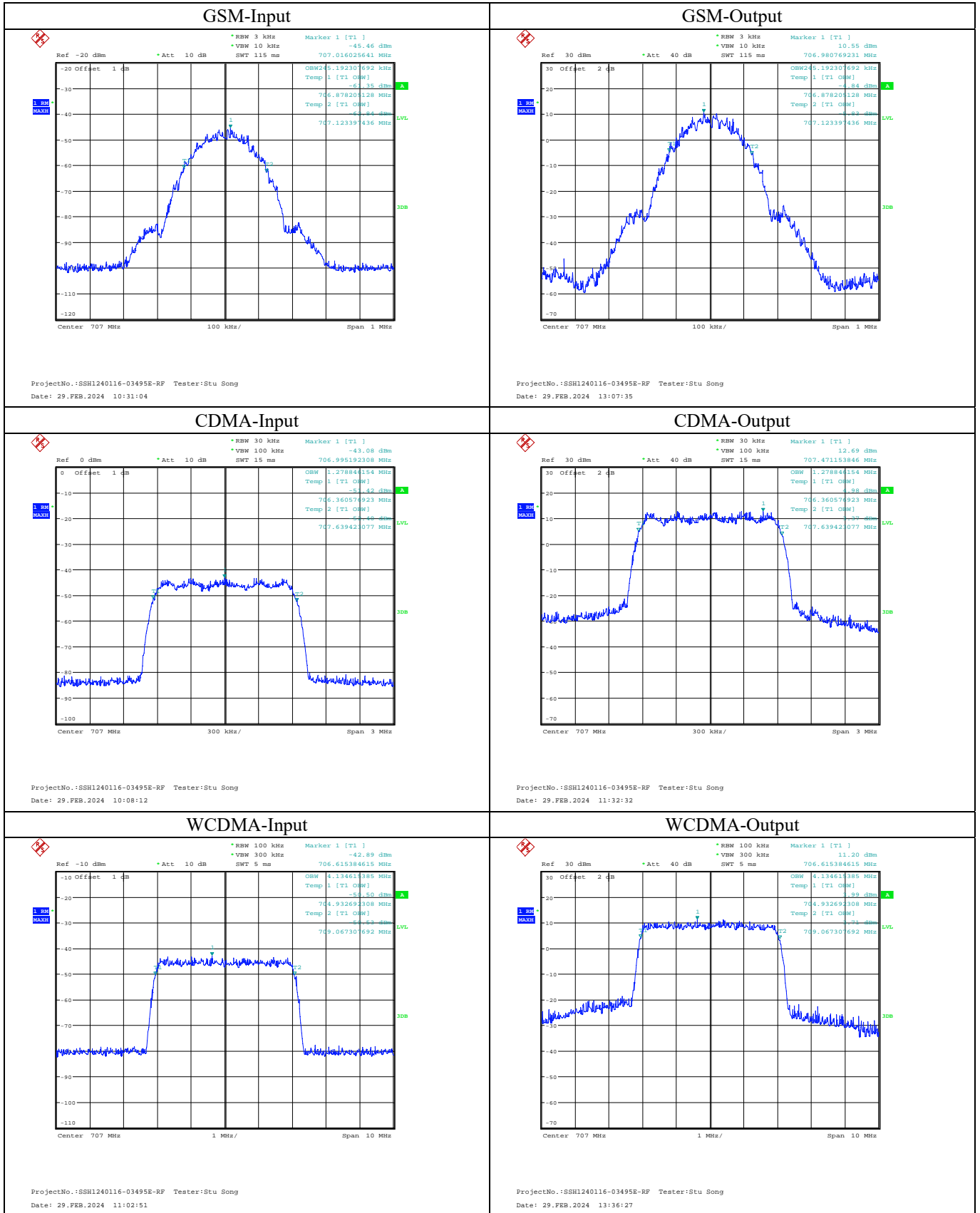

Upper 700M Band

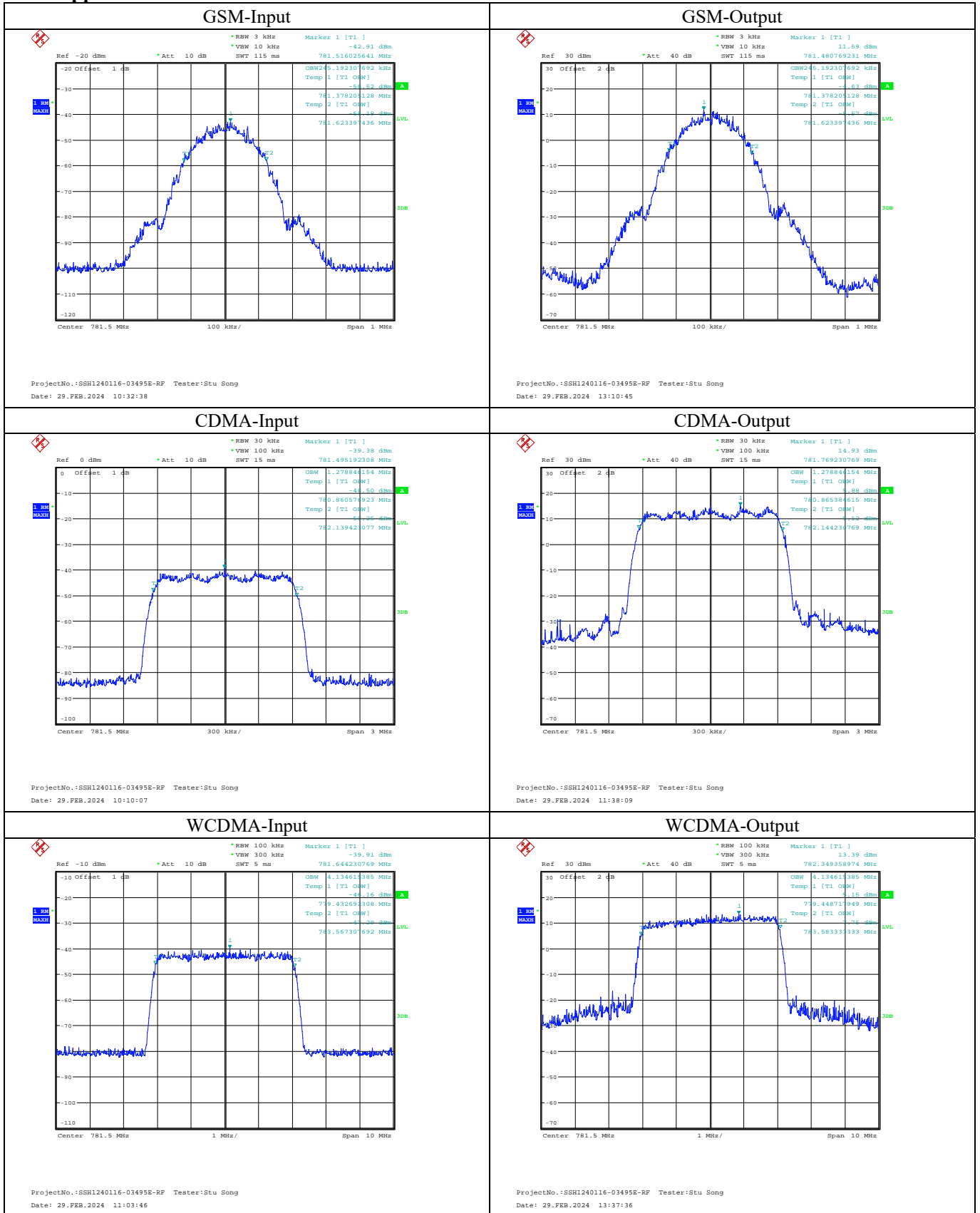

Cellular Band

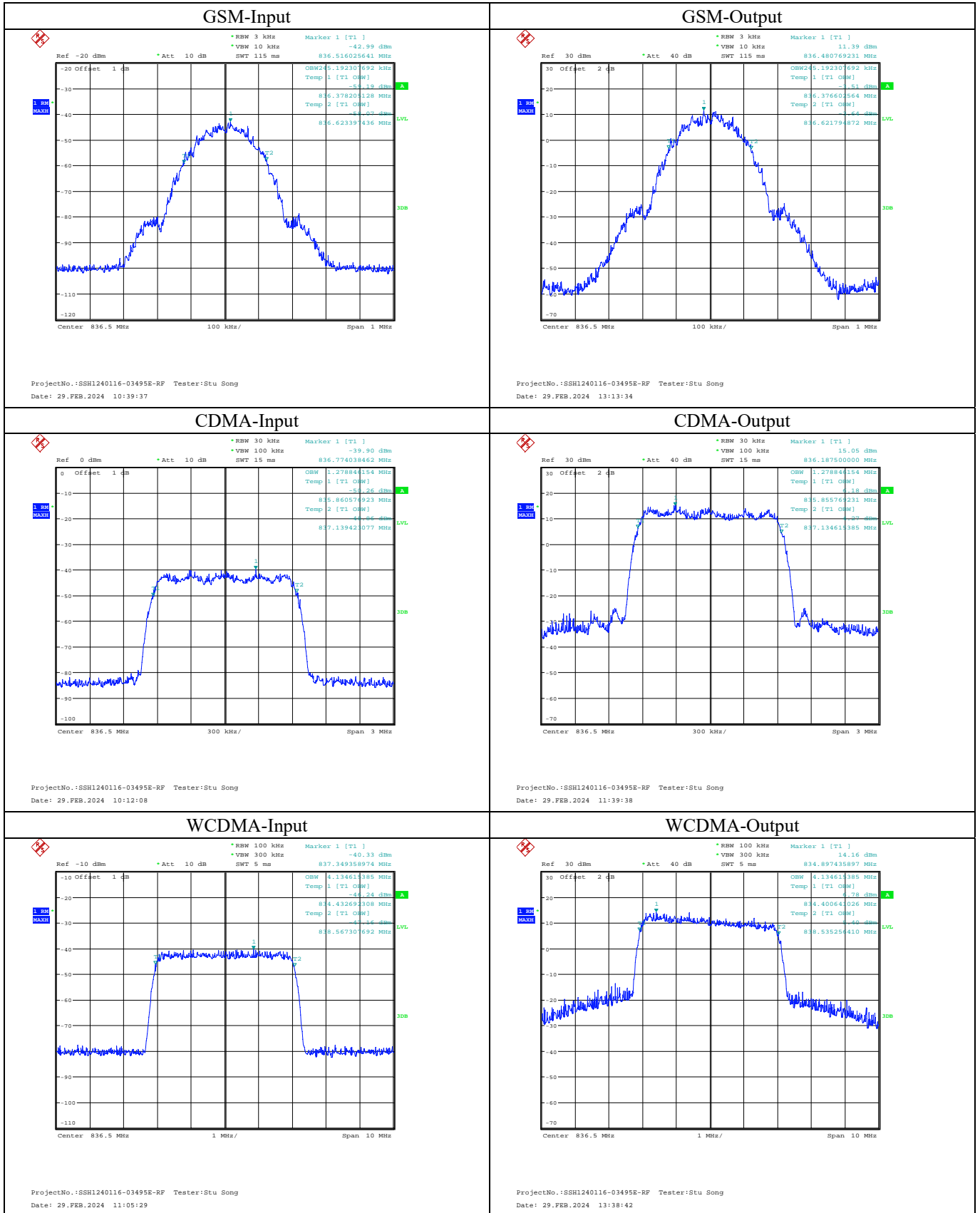

**AWS-1 Band**

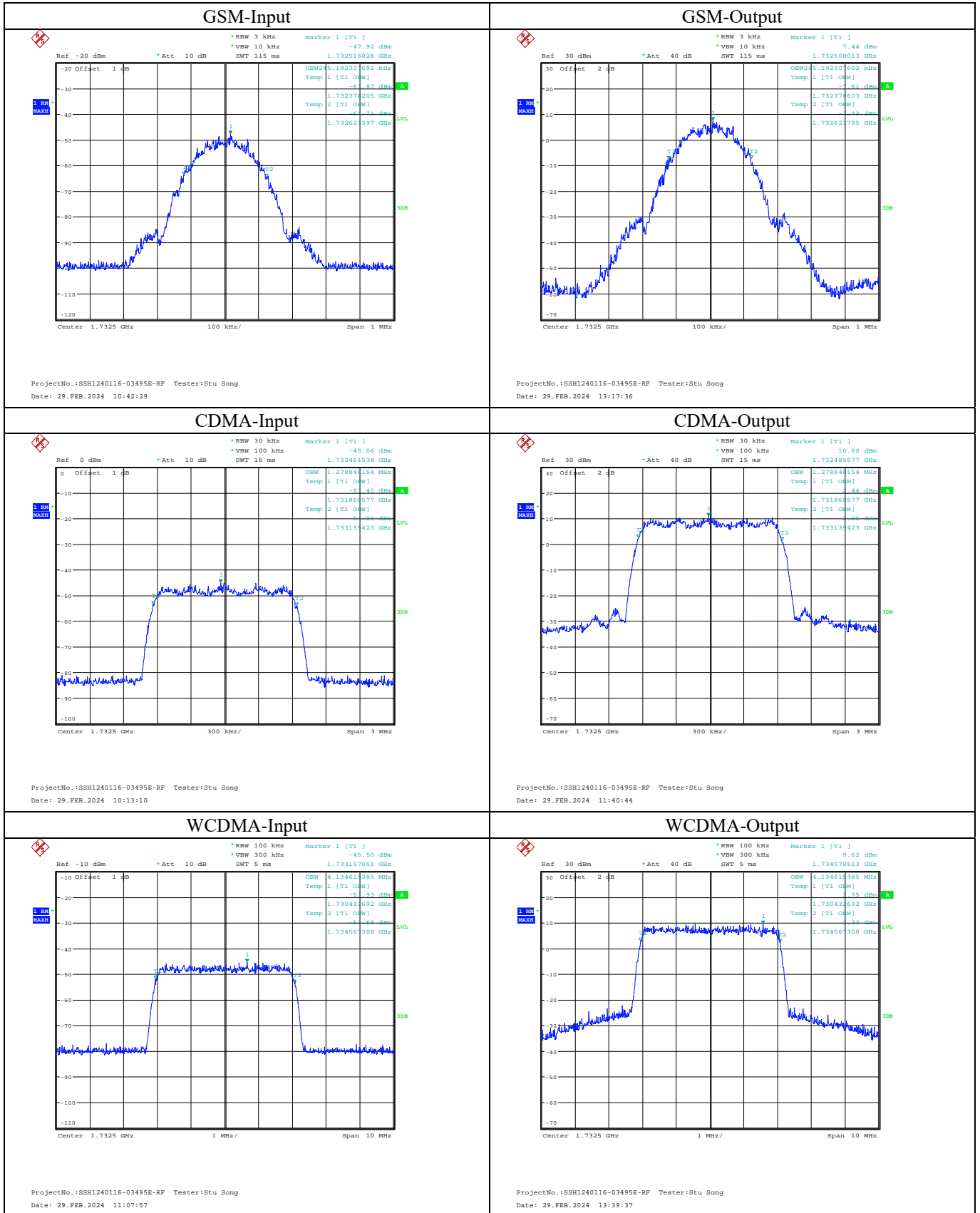

PCS Band

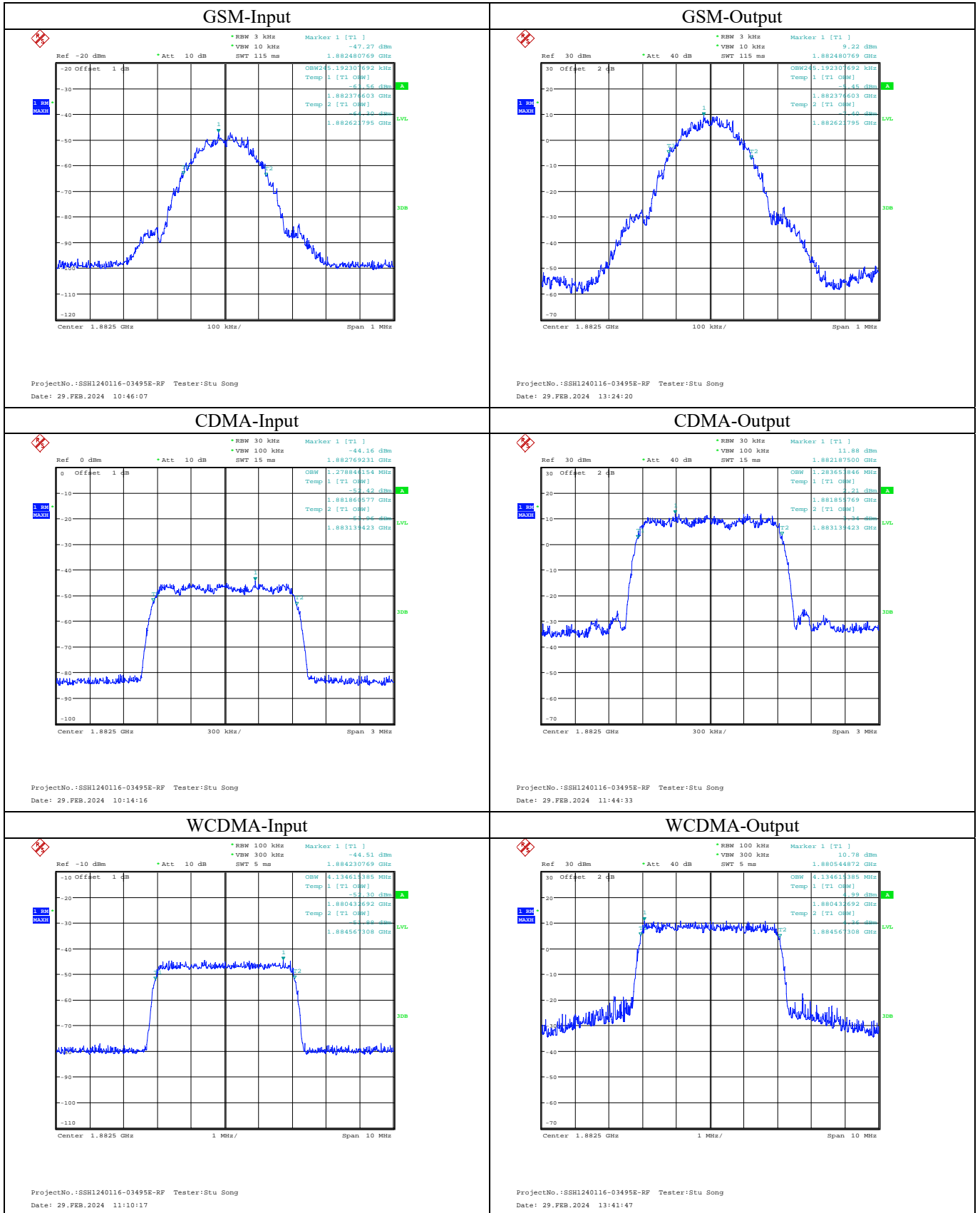



**Downlink:  
Lower 700M Band**

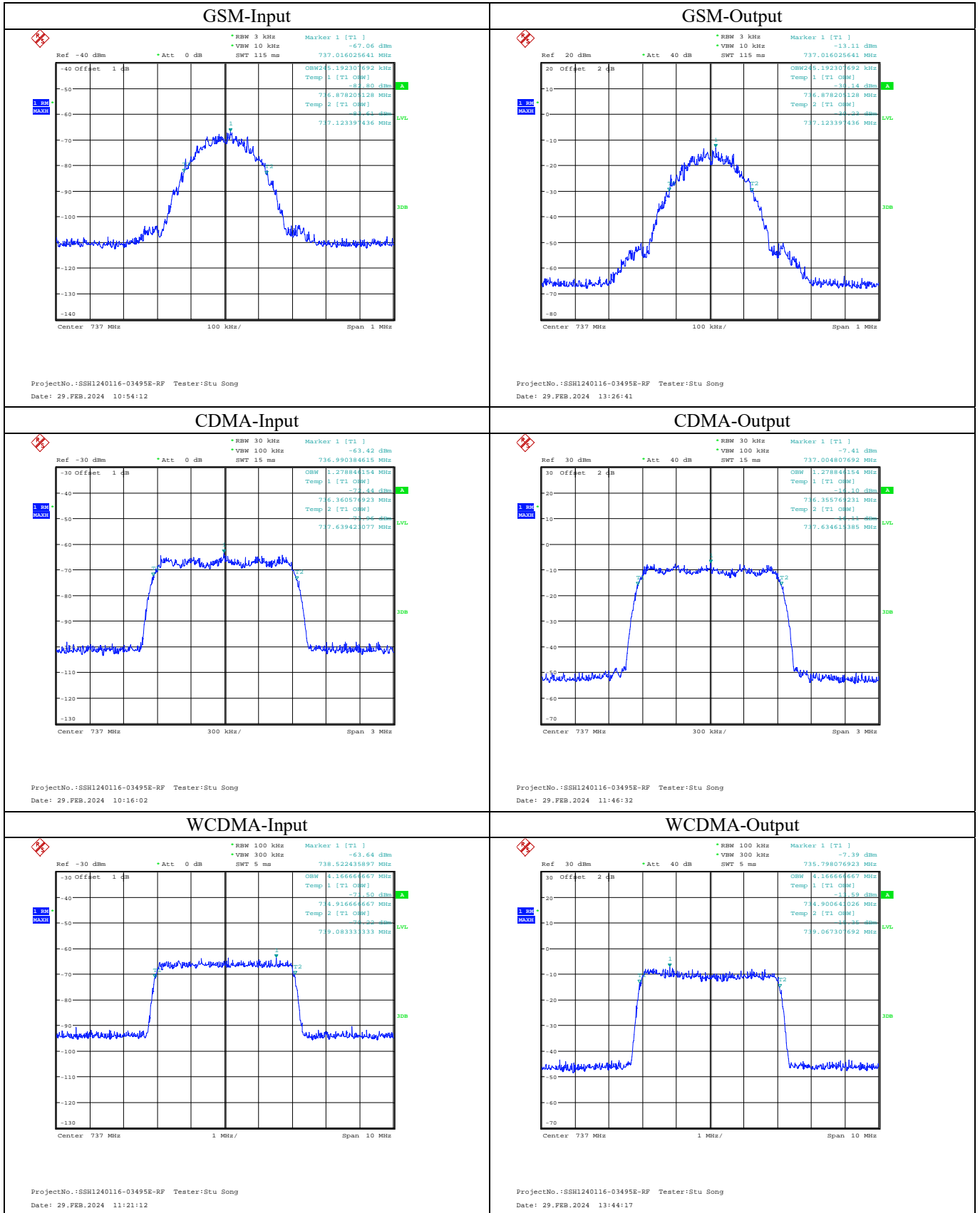

Upper 700M Band

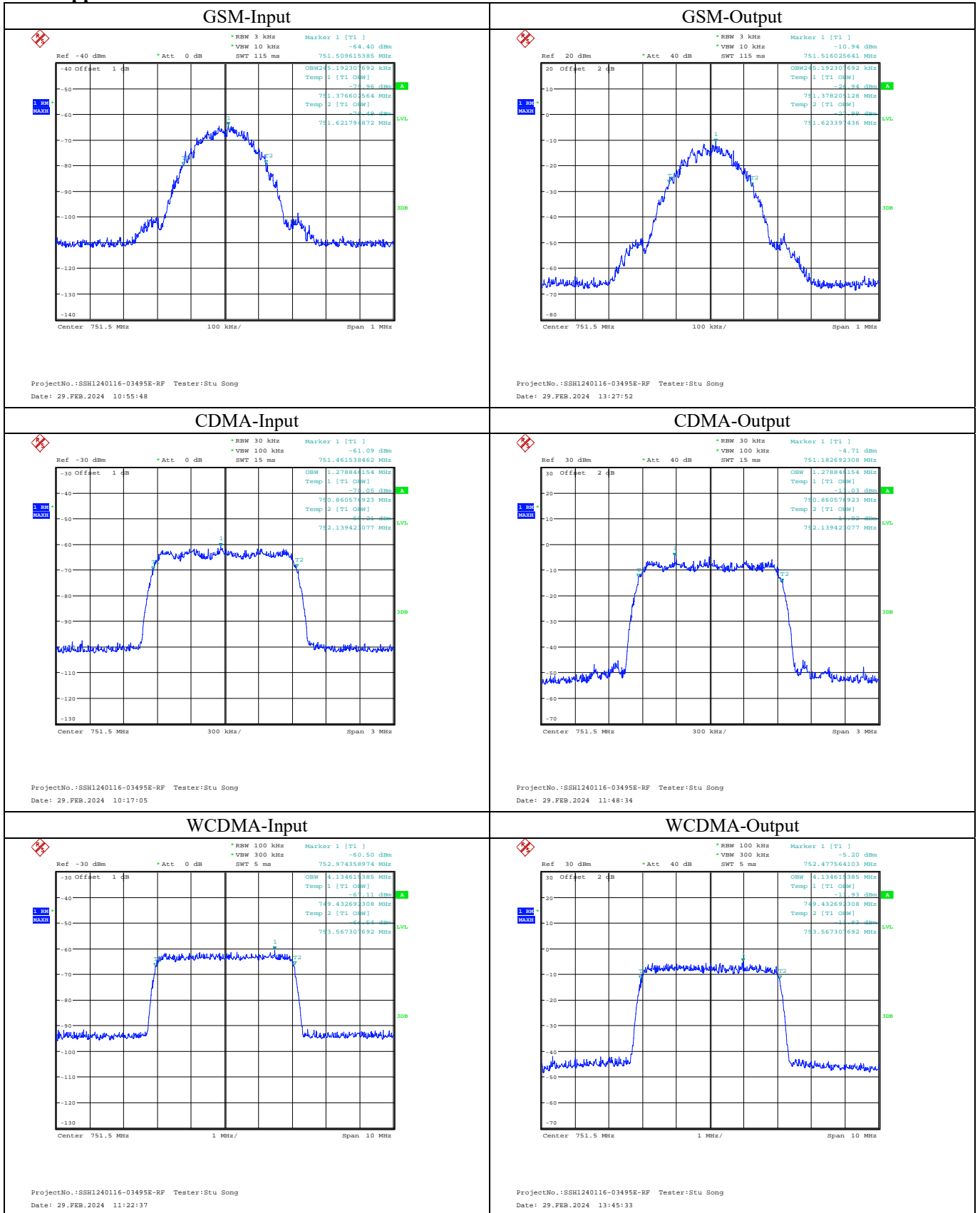

Cellular Band

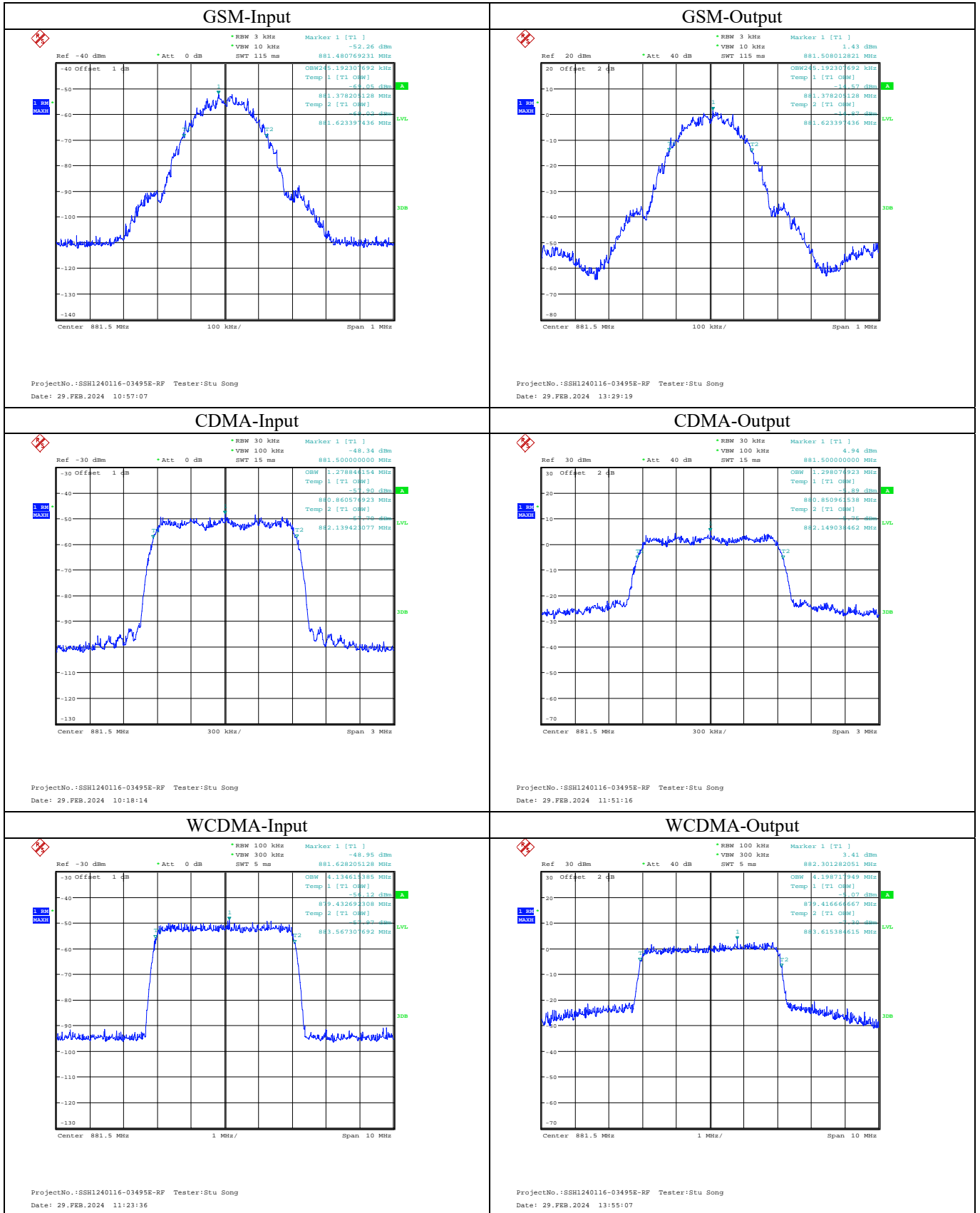

**AWS-1 Band**

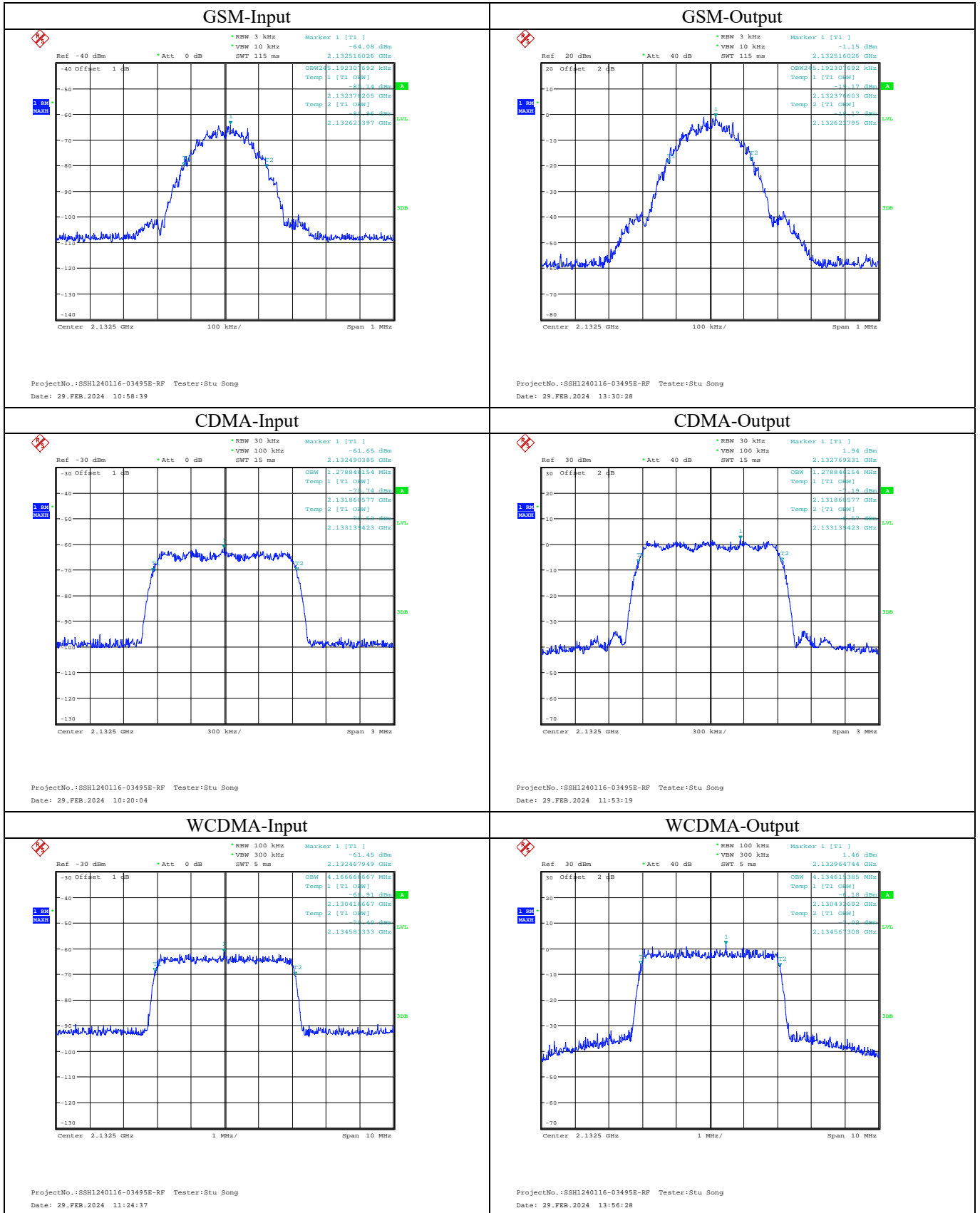

PCS Band

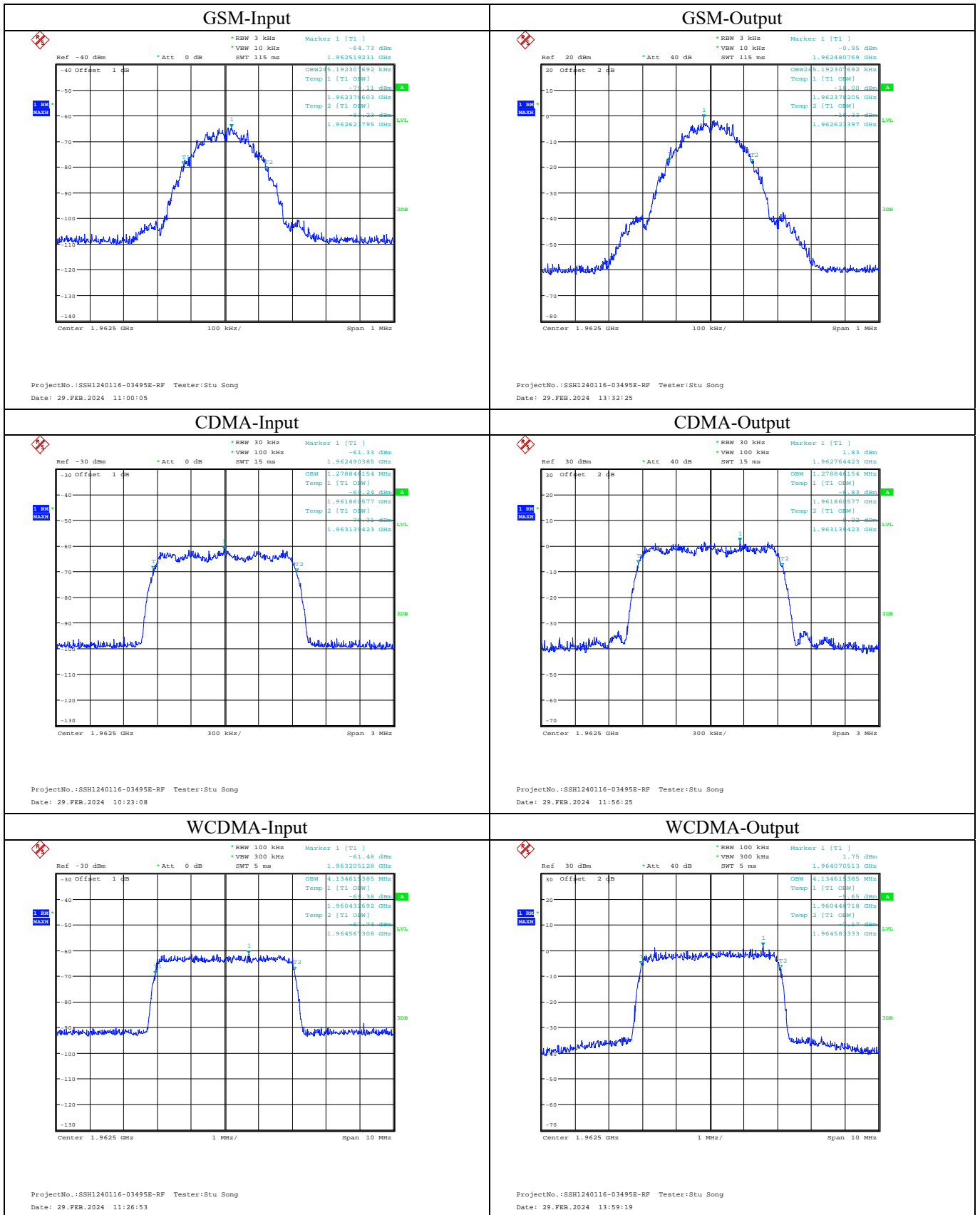

## 4.11 Oscillation Detection

### 4.11.1 Applicable Standard

According to § 20.21(e)(8)(ii)(A) *Anti-Oscillation*, §20.21(e)(4) *Self-monitoring*.

Use of two EUTs is permitted for this measurement, which can greatly reduce the test time required. One EUT shall operate in a normal mode, and the second EUT shall operate in a test mode that is capable of disabling the uplink inactivity function and/or allows a reduction to 5 seconds of the time between restarts.

The procedures in 7.11.3 and 7.11.4 do not apply for devices that operate only as direct-connection mobile boosters having gain of less than or equal to 15 dB.

### 4.11.2 Test Procedure

#### 4.11.3 Oscillation restart tests

- a) Connect the normal-operating mode EUT to the test equipment as shown in **Figure 7** beginning with the spectrum analyzer on the uplink output (donor) port. Confirm that the RF coupled path is connected to the spectrum analyzer.

*NOTE—The band-pass filter shall provide sufficient out-of-band rejection to prevent oscillations from occurring in bands not under test.*

- b) Spectrum analyzer settings:

- 1) Center frequency at the center of the band under test
- 2) Span equal or slightly exceeding the width of the band under test
- 3) Continuous sweep, max-hold
- 4)  $RBW \geq 1$  MHz,  $VBW > 3 * RBW$

- c) Decrease the variable attenuator until the spectrum analyzer displays a signal within the band under test. Using a marker, identify the approximate center frequency of this signal on the max-hold display, increase the attenuation by 10 dB, then reset the EUT (e.g., cycle ac/dc power).
- d) Repeat 7.11.2c) twice to ensure that the center of the signal created by the booster remains within 250 kHz of the spectrum analyzer display center frequency. If the frequency of the signal is unstable, confirm that the spectrum analyzer display is centered between the frequency extremes observed. If the signal is wider than 1 MHz, ensure that the spectrum analyzer display is centered on the signal by increasing the RBW. Reset the EUT (e.g., cycle ac/dc power) after each oscillation event, if necessary. Set the spectrum analyzer sweep trigger level to just below the peak amplitude of the displayed EUT oscillation signal.
- e) Set the spectrum analyzer to zero-span, with a sweep time of 5 seconds, and single-sweep with max-hold. The spectrum analyzer sweep trigger level in this and the subsequent steps shall be the level identified in 7.11.2d).
- f) Decrease the variable attenuator until the spectrum analyzer sweep is triggered, increase the attenuation by 10 dB, then reset the EUT (e.g., cycle ac/dc power).
- g) Reset the zero-span trigger of the spectrum analyzer, then repeat 7.11.2f) twice to ensure that the spectrum analyzer is reliably triggered, resetting the EUT (e.g., cycle ac/dc power) after each oscillation event if necessary.
- h) Reset the zero-span sweep trigger of the spectrum analyzer, and reset the EUT (e.g., cycle ac/dc power).
- i) Force the EUT into oscillation by reducing the attenuation.
- j) Use the marker function of the spectrum analyzer to measure the time from the onset of oscillation until the EUT turns off, by setting Marker 1 on the leading edge of the oscillation signal and Marker 2 on the trailing edge. The spectrum analyzer sweep time may be adjusted to improve the time resolution of these cursors.
- k) Capture the spectrum analyzer zero-span trace for inclusion in the test report. Report the power level

- associated with the oscillation separately if it can't be displayed on the trace.
- l) Repeat 7.11.2b) to 7.11.2k) for all operational uplink and downlink bands.
  - m) Set the spectrum analyzer zero-span sweep time for longer than 60 seconds, then measure the restart time for each operational uplink and downlink band.
  - n) Replace the normal-operating mode EUT with the EUT that supports an anti-oscillation test mode.
  - o) Set the spectrum analyzer zero-span time for a minimum of 120 seconds, and a single sweep.
  - p) Manually trigger the spectrum analyzer zero-span sweep, and manually force the booster into oscillation as described in 7.11.2i).
  - q) When the sweep is complete, place cursors between the first two oscillation detections, and save the plot for inclusion in the test report. The time between restarts must match the manufacturer's timing for the test mode, and there shall be no more than 5 restarts.
  - r) Repeat 7.11.2m) to 7.11.2q) for all operational uplink and downlink bands.

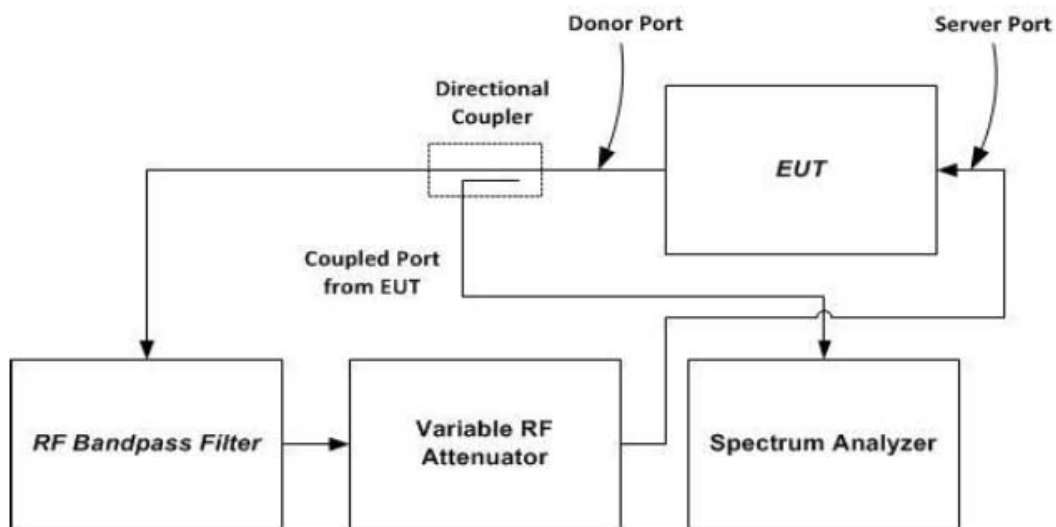

NOTE—This figure shows the test setup for uplink bands transmission path tests; i.e., signal flow is out from the donor port into the directional coupler. For downlink bands transmission path tests, the feedback signal flow path direction and equipment connections shall be reversed, i.e., signal flow is out from the server port into the directional coupler, and signal flow is into the donor port from the variable RF attenuator.

Figure 7 – Oscillation detection (7.11.2) test setup

### Test procedure for measuring oscillation mitigation or shutdown

- a) Connect the normal-operating mode EUT to the test equipment as shown in **Figure 8**.
- b) Set the spectrum analyzer center frequency to the center of band under test, and use the following settings:
  - 1) RBW=30 kHz, VBW  $\geq 3 \times$  RBW,
  - 2) power averaging (rms) detector,
  - 3) trace averages  $\geq 100$ ,
  - 4) span  $\geq 120\%$  of operational band under test,
  - 5) number of sweep points  $\geq 2 \times$  Span/RBW.

NOTE—To measure 120% of the band under test in one span with spectrum analyzers having less than the required number of sweep points: Perform pretests with span equal to smaller band segments, such that 120% of the operational band is captured in multiple tests, using the setup parameters specified; record the center frequency of the strongest oscillation level occurring, and affirm this frequency is within the span and band segment used in this test.

- c) Configure the signal generator for AWGN operation with a 99% OBW of 4.1 MHz, tuned to the frequency of 2.5 MHz above the lower edge or below the upper edge of the operating band under test. Adjust the RF output level of the signal generator such that the measured power level of the AWGN signal at the output port of the booster is 30 dB less than the maximum power of the booster

for the band under test. Affirm that the input signal is not obstructing the measurement of the strongest oscillation peak in the band, and is not included within the span in the measurement.

- 1) Boosters with operating spectrum passbands of 10 MHz or less may use a CW signal source at the band edge rather than AWGN.
- 2) For device passbands greater than 10 MHz, standard CMRS signal sources (i.e., CDMA, W-CDMA, LTE) may be used instead of AWGN at the band edge.
- d) Set the variable attenuator to a high attenuation setting such that the booster will operate at maximum gain when powered on. Reset the EUT (e.g., cycle ac/dc power). Allow the EUT to complete its boot-up process, to reach full operational gain, and to stabilize its operation.
- e) Set the variable attenuator such that the insertion loss for the center of the band under test (isolation) between the booster donor port and server port is 5 dB greater than the maximum gain, as recorded in the maximum gain test procedure (see 7.3), for the band under test.
- f) Verify the EUT shuts down, i.e., to mitigate the oscillations. If the booster does not shut down, measure and verify the peak oscillation level as follows.
  - 1) Allow the spectrum analyzer trace to stabilize.
  - 2) Place the marker at the highest oscillation level occurring within the span, and record its output level and frequency.
  - 3) Set the spectrum analyzer center frequency to the frequency with the highest oscillation signal level, and reduce the span such that the upper and lower adjacent oscillation peaks are within the span.
  - 4) Use the Minimum Search Marker function to find the lowest output level that is within the span, and within the operational band under test, and record its output level and frequency.
  - 5) Affirm that the peak oscillation level measured in 7.11.3f2), does not exceed by 12.0 dB the minimal output level measured in 7.11.3f4). Record the measurement results of 7.11.3f2) and 7.11.3f4) in tabular format for inclusion in the test report.
  - 6) The procedure of 7.11.3f1) to 7.11.3f5) allows the spectrum analyzer trace to stabilize, and verification of shutdown or oscillation level measurement must occur within 300 seconds.<sup>20</sup>
- g) Decrease the variable attenuator in 1 dB steps, and repeat step 7.11.3f) for each 1 dB step. Continue testing to the level when the insertion loss for the center of band under test (isolation) between the booster donor port and server port is 5 dB lower than the maximum gain (see 7.3).
- h) Repeat 7.11.3a) to 7.11.3g) for all operational uplink and downlink bands.



**4.11.3 Test Result**

Serial Number:	2G05-5	Test Date:	2024/2/29~2024/3/24
Test Site:	RF	Test Mode:	Transmitting
Tester:	Stu Song	Test Result:	Pass

**Environmental Conditions:**

Temperature: (°C)	22.6~25.6	Relative Humidity: (%)	38~64	ATM Pressure: (kPa)	100.4~101.4
----------------------	-----------	---------------------------	-------	------------------------	-------------

**Test Equipment List and Details:**

Manufacturer	Description	Model	Serial Number	Calibration Date	Calibration Due Date
R&S	Spectrum Analyzer	FSU 26	200160/026	2023/10/18	2024/10/17
yzjingcheng	Coaxial Cable	KTRFBU-141-50	41010012	2023/9/1	2024/8/31
yzjingcheng	Coaxial Cable	KTRFBU-141-50	41010013	2023/9/1	2024/8/31
yzjingcheng	Coaxial Cable	KTRFBU-141-50	41005011	2023/9/1	2024/8/31
yzjingcheng	Coaxial Cable	KTRFBU-141-50	41005012	2023/9/1	2024/8/31
Eastsheep	Coaxial Attenuator	5W-N-JK-6G-10dB	F-08-EM502	2023/9/10	2024/9/9
Narda	Directional Coupler	4242-10	02933	2023/12/4	2024/12/3
Narda	Directional Coupler	4242-10	03304	2023/12/4	2024/12/3
TRILITHIC	Step Attenuator	RSA-2570D-SMA	T200537364	2023/12/15	2024/12/14
Agilent	MXG Vector Signal Generator	N5182B	MY51350142	2023/9/1	2024/8/31

\* Statement of Traceability: Bay Area Compliance Laboratories Corp. (Dongguan) attests that all calibrations have been performed, traceable to National Primary Standards and International System of Units (SI).

**Test Data:**

**Oscillation Restart Time:**

Mode	Operation Bands	Detection Time (s)		Power level dBm	Between restart time (s)		Number of restart		
		Reading	Limit		Reading	Limit	Reading	Limit	
Uplink	Lower 700MHz	0.088	<0.3	16.83	≥60	68.23	3	≤5	
	Upper 700MHz	0.088		17.2					68.10
	Cellular	0.096		16.24					67.84
	AWS-1	0.112		15.12					68.38
	PCS	0.088		16.19					68.27
Downlink	Lower 700MHz	0.112	<1	2.81	≥60	68.34	3	≤5	
	Upper 700MHz	0.120		-14.1					68.59
	Cellular	0.184		3.39					68.27
	AWS-1	0.176		8.39					68.27
	PCS	0.176		8.98					68.59

Lower 700M-Uplink

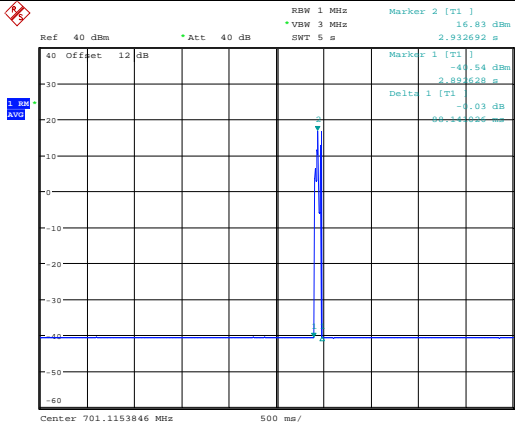

ProjectNo.:SSH1240116-03495E-RF Tester:Stu Song  
Date: 29.FEB.2024 17:36:03

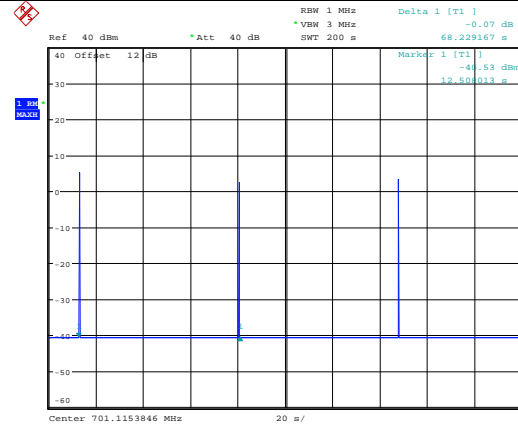

ProjectNo.:SSH1240116-03495E-RF Tester:Stu Song  
Date: 29.FEB.2024 17:40:47

Upper 700M-Uplink

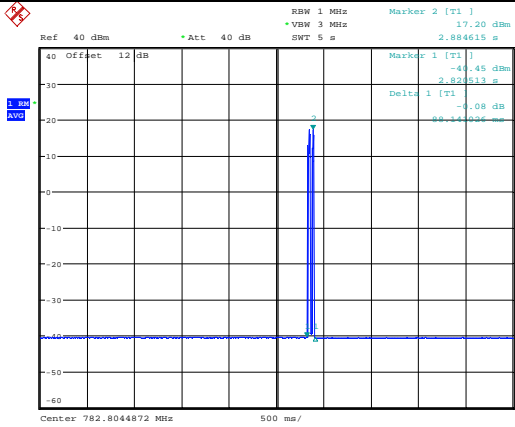

ProjectNo.:SSH1240116-03495E-RF Tester:Stu Song  
Date: 29.FEB.2024 17:45:17

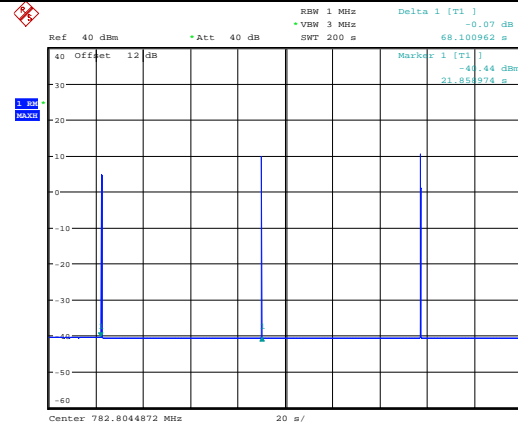

ProjectNo.:SSH1240116-03495E-RF Tester:Stu Song  
Date: 29.FEB.2024 17:49:39

Cellular-Uplink

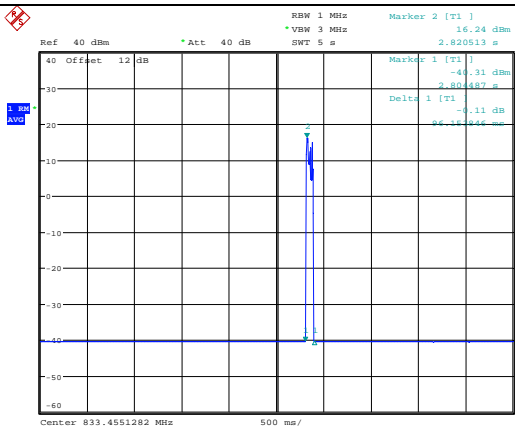

ProjectNo.:SSH1240116-03495E-RF Tester:Stu Song  
Date: 29.FEB.2024 17:57:25

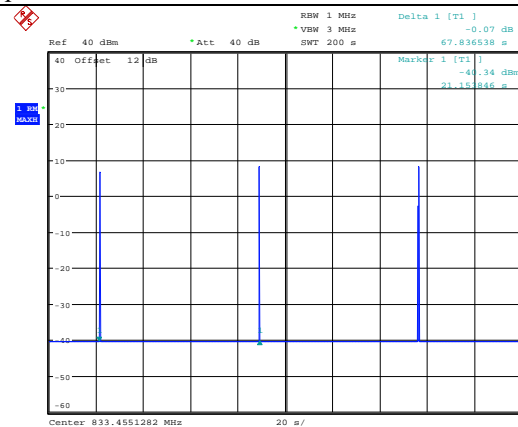

ProjectNo.:SSH1240116-03495E-RF Tester:Stu Song  
Date: 29.FEB.2024 18:02:47

### AWS-1-Uplink

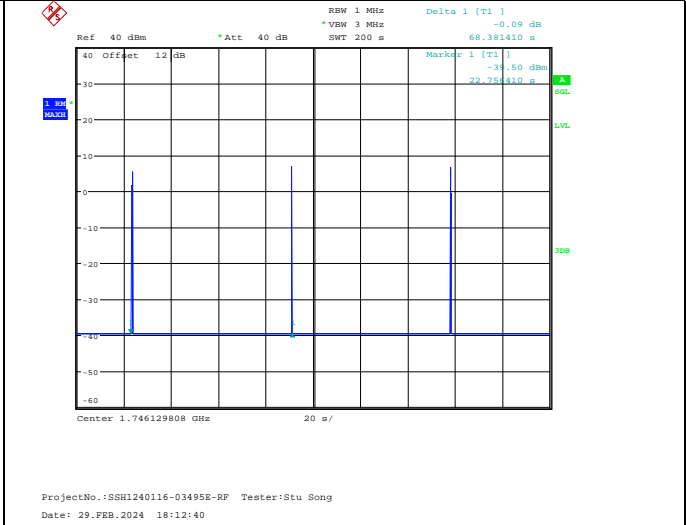

### PCS-Uplink

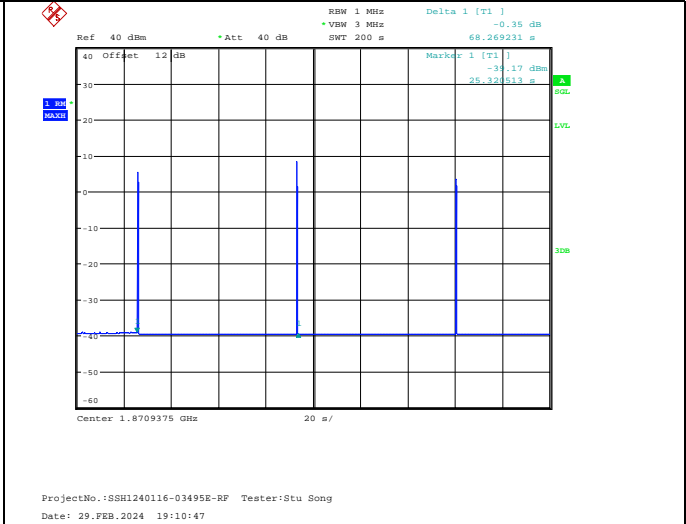
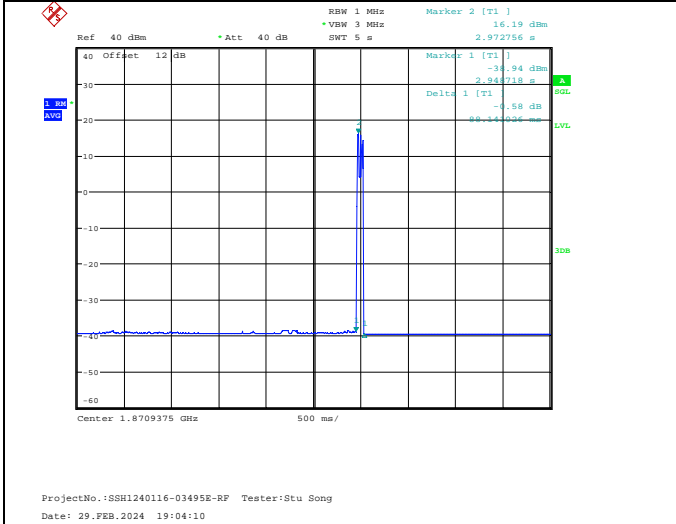

### Lower 700M-Downlink

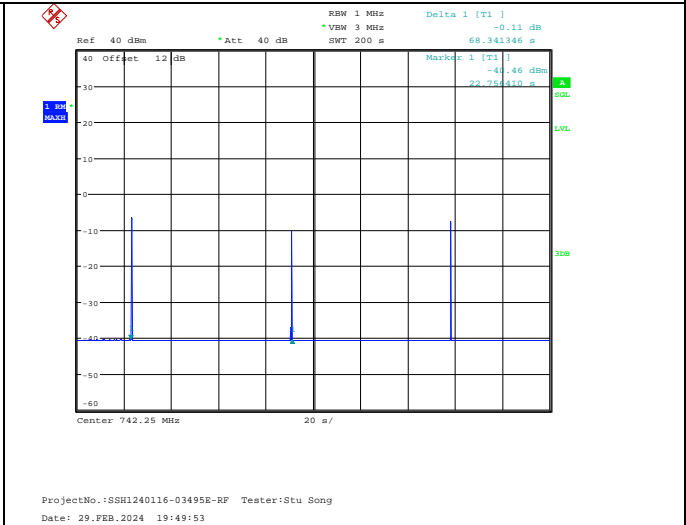
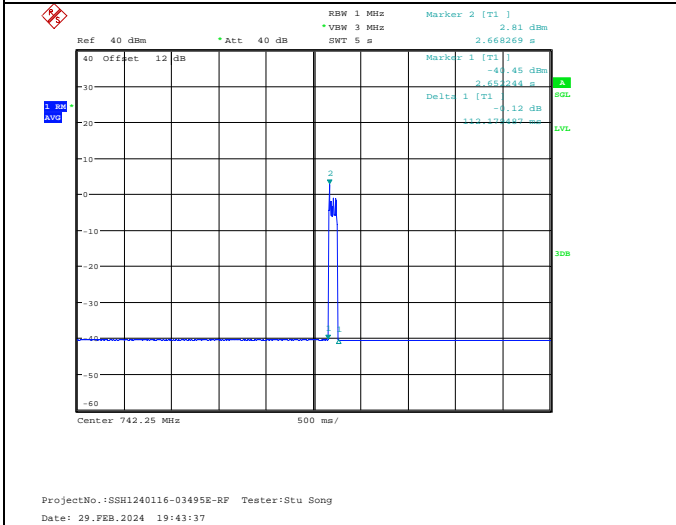

Upper 700M-Downlink

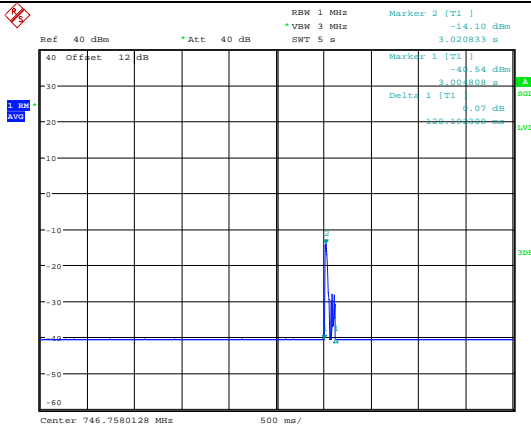

ProjectNo.:SSH1240116-03495E-RF Tester:Stu Song  
Date: 29.FEB.2024 21:33:16

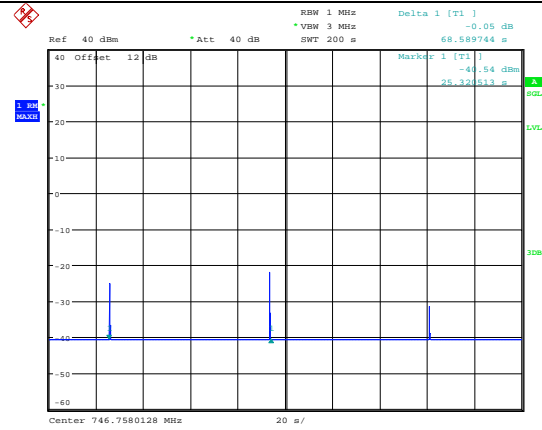

ProjectNo.:SSH1240116-03495E-RF Tester:Stu Song  
Date: 29.FEB.2024 21:40:28

Cellular-Downlink

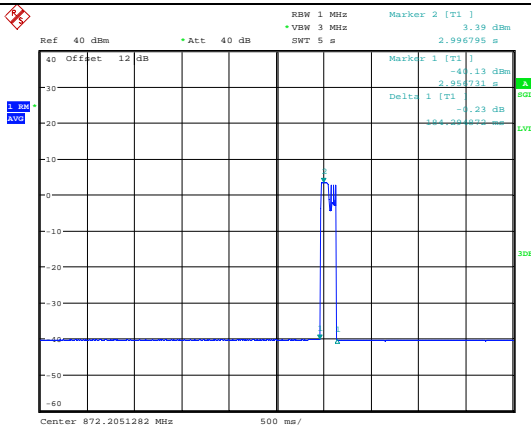

ProjectNo.:SSH1240116-03495E-RF Tester:Stu Song  
Date: 29.FEB.2024 20:28:52

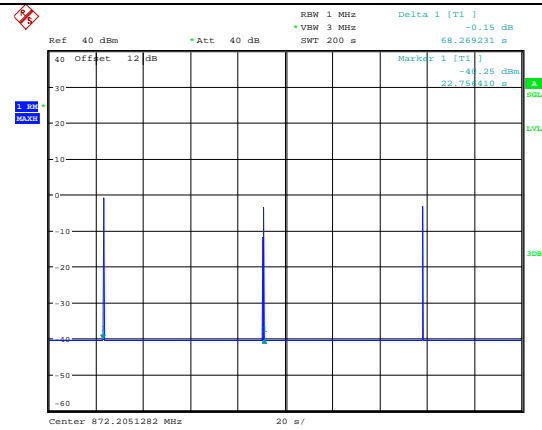

ProjectNo.:SSH1240116-03495E-RF Tester:Stu Song  
Date: 29.FEB.2024 20:35:13

AWS-1-Downlink

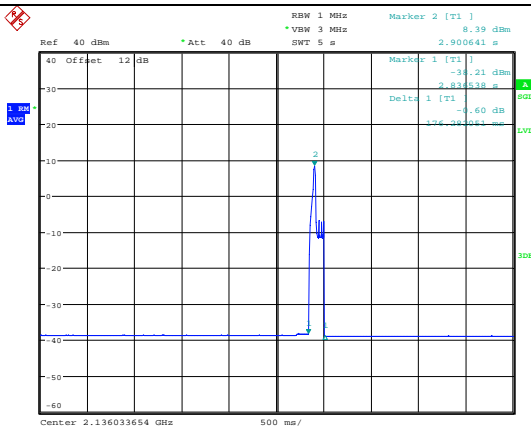

ProjectNo.:SSH1240116-03495E-RF Tester:Stu Song  
Date: 29.FEB.2024 20:46:20

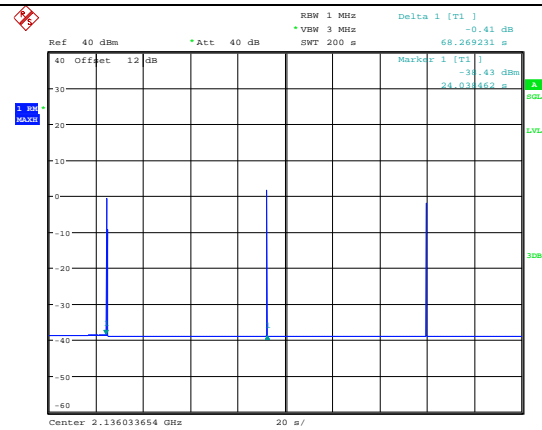

ProjectNo.:SSH1240116-03495E-RF Tester:Stu Song  
Date: 29.FEB.2024 21:00:38

PCS-Downlink

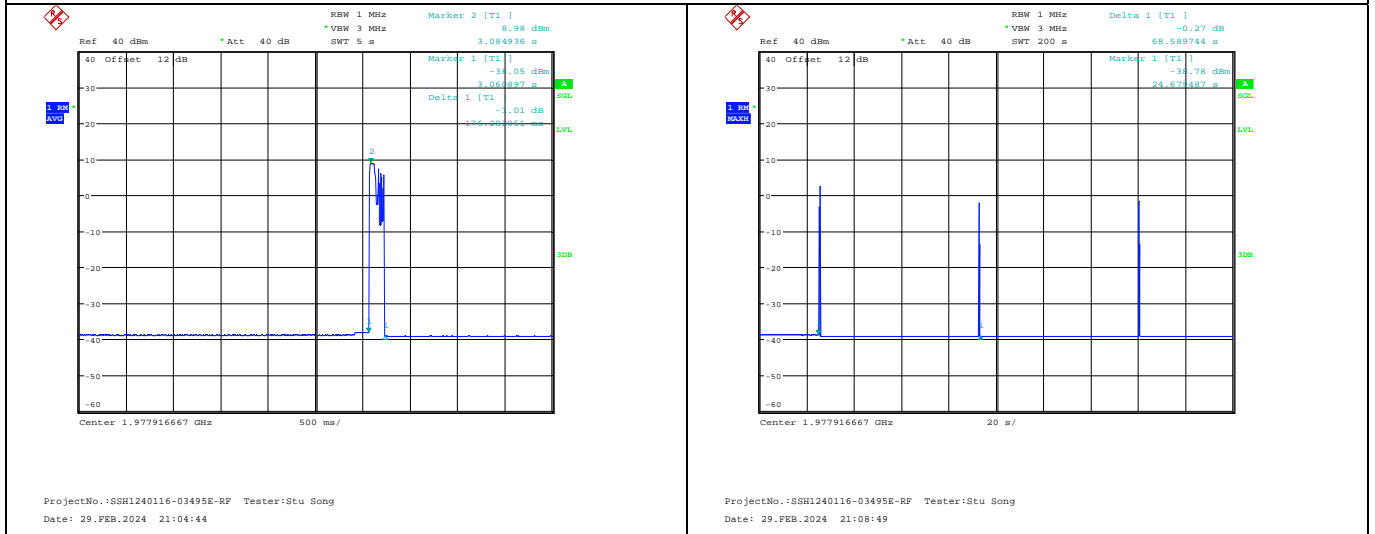

**Oscillation Mitigation or Shutdown:**

Mode	Operation Band	Maximum Gain	Isolation	Difference	Limit	Time to Mitigate Oscillation	Mitigation Time Limit
		dB	dB	dB	dB	s	s
Uplink	Lower 700MHz	54.32	+5	8.38	12	/	<300
			+4	9.38	12	/	<300
			+3	10.45	12	/	<300
			+2	11.49	12	/	<300
			+1	11.95	12	/	<300
			+0	13.48	12	276.30	<300
			-1	15.35	12	276.30	<300
			-2	17.00	12	275.74	<300
			-3	20.83	12	275.74	<300
			-4	24.10	12	276.30	<300
			-5	36.62	12	276.30	<300
	Upper 700MHz	52.57	+5	7.94	12	/	<300
			+4	8.15	12	/	<300
			+3	9.05	12	/	<300
			+2	8.93	12	/	<300
			+1	9.93	12	/	<300
			+0	10.30	12	/	<300
			-1	10.63	12	/	<300
			-2	11.36	12	/	<300
			-3	12.76	12	276.30	<300
			-4	14.14	12	275.74	<300
			-5	15.85	12	276.30	<300
	Cellular	52.8	+5	11.63	12	/	<300
			+4	13.45	12	266.31	<300
			+3	15.28	12	266.88	<300
			+2	17.58	12	266.88	<300
			+1	20.67	12	266.88	<300
			+0	25.81	12	266.88	<300
			-1	46.12	12	266.31	<300
			-2	87.47	12	266.88	<300
			-3	shut down	12	/	<300
			-4	shut down	12	/	<300
			-5	shut down	12	/	<300
	AWS-1	57.1	+5	9.09	12	/	<300
			+4	10.22	12	/	<300
			+3	9.34	12	/	<300
			+2	9.43	12	/	<300
			+1	10.54	12	/	<300
			+0	12.55	12	277.98	<300
			-1	12.69	12	276.86	<300

			-2	12.88	12	276.86	<300
			-3	15.50	12	276.86	<300
			-4	18.55	12	276.86	<300
			-5	25.01	12	276.86	<300
	PCS	57.46	+5	7.37	12	/	<300
			+4	7.17	12	/	<300
			+3	7.70	12	/	<300
			+2	8.24	12	/	<300
			+1	9.08	12	/	<300
			+0	9.51	12	/	<300
			-1	10.55	12	/	<300
			-2	11.41	12	/	<300
			-3	12.07	12	276.86	<300
			-4	13.49	12	276.86	<300
			-5	14.76	12	276.86	<300

Note: "/" means that booster is shut down.

Mode	Operation Band	Max gain	Isolation	Difference	Limit	Time to Mitigate Oscillation	Mitigation time Limit
		dB	dB	dB	dB	s	s
Downlink	Lower 700MHz	57.83	+5	9.35	12	/	<300
			+4	10.18	12	/	<300
			+3	11.26	12	/	<300
			+2	12.20	12	140.57	<300
			+1	13.13	12	140.57	<300
			+0	14.11	12	140.89	<300
			-1	16.24	12	140.57	<300
			-2	17.77	12	140.89	<300
			-3	21.53	12	141.28	<300
			-4	shut down	12	/	<300
	-5	shut down	12	/	<300		
	Upper 700MHz	53.55	+5	10.56	12	/	<300
			+4	10.95	12	/	<300
			+3	13.07	12	140.48	<300
			+2	13.67	12	140.80	<300
			+1	15.59	12	140.80	<300
			+0	shut down	12	/	<300
			-1	shut down	12	/	<300
			-2	shut down	12	/	<300
			-3	shut down	12	/	<300
			-4	shut down	12	/	<300
	-5	shut down	12	/	<300		
	Cellular	50.67	+5	12.48	12	140.80	<300
			+4	13.33	12	140.80	<300
			+3	15.21	12	140.80	<300
			+2	17.94	12	140.80	<300
			+1	20.30	12	140.80	<300
			+0	shut down	12	/	<300
			-1	shut down	12	/	<300
			-2	shut down	12	/	<300
			-3	shut down	12	/	<300
			-4	shut down	12	/	<300
	-5	shut down	12	/	<300		
	AWS-1	61.58	+5	11.18	12	/	<300
			+4	12.15	12	141.40	<300
			+3	12.68	12	141.08	<300
			+2	14.21	12	141.40	<300
			+1	16.30	12	141.08	<300
			+0	16.16	12	141.08	<300
			-1	17.95	12	142.04	<300
-2			19.84	12	141.40	<300	



			-3	21.50	12	141.08	<300
			-4	24.95	12	141.08	<300
			-5	34.19	12	141.08	<300
	PCS	61.05	+5	8.74	12	/	<300
			+4	9.61	12	/	<300
			+3	9.86	12	/	<300
			+2	11.10	12	/	<300
			+1	10.88	12	/	<300
			+0	11.91	12	/	<300
			-1	12.09	12	141.04	<300
			-2	12.73	12	141.04	<300
			-3	13.65	12	141.04	<300
			-4	15.56	12	141.36	<300
			-5	shut down	12	/	<300

Note: "/" means that booster is shut down.

## 4.12 Radiated Spurious Emissions

### 4.12.1 Applicable Standard

According to § 2.1053 *Measurements required: Field strength of spurious radiation.*

### 4.12.2 Test Procedure

This procedure is intended to satisfy the requirements specified in Section 2.1053. The applicable limits are those specified for mobile station emissions in the rule part appropriate to the band of operation (see Appendix A).

Separate compliance requirements are applicable for any digital device circuitry that controls additional functions or capabilities and that is not used only to enable operation of the transmitter in a booster device [i.e., Section 15.3(k) digital device definition]. Separate compliance requirements are applicable for any receiver components/functions that tune within 30 MHz to 960 MHz contained in booster devices [Section 15.101(b)].

- a) Place the EUT on an OATS or semi-anechoic chamber turntable 3 m from the receiving antenna.
- b) Connect the EUT to the test equipment as shown in **Figure 10** beginning with the uplink output (donor) port.
- c) Set the signal generator to produce a CW signal with the frequency set to the center of the operational band under test, and the power level set at PIN as determined from measurement results per 7.2.
- d) Measure the radiated spurious emissions from the EUT from the lowest to the highest frequencies as specified in Section 2.1057. Maximize the radiated emissions by using the procedures described in ANSI C63.26.
- e) Capture the peak emissions plots using a peak detector with Max-Hold for inclusion in the test report. Tabular data is acceptable in lieu of spectrum analyzer plots.
- f) Repeat 7.12c) through 7.12e) for all uplink and downlink operational bands.

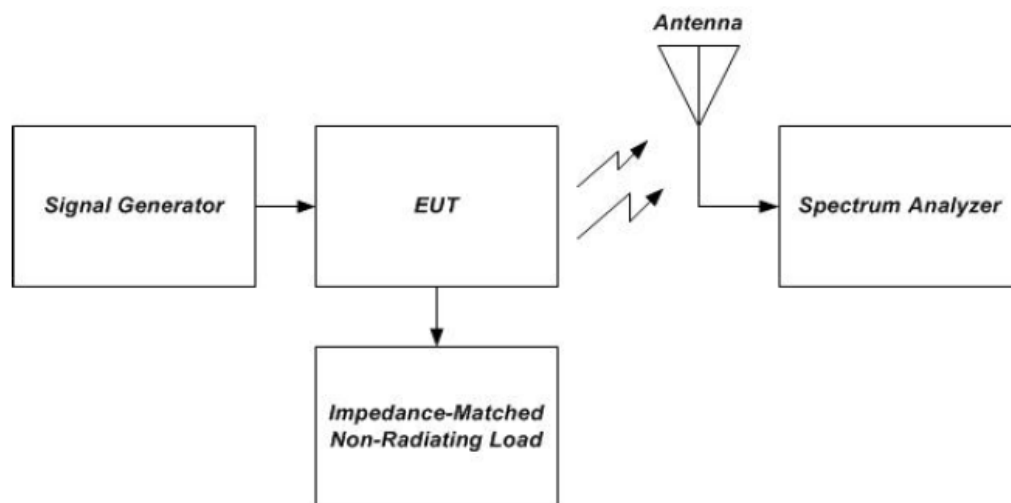

**Figure 10 – Radiated spurious emissions test instrumentation setup**

**4.12.3 Test Result**

Serial Number:	2G05-5, 2G05-6	Test Date:	Below 1GHz: 2024/3/8 Above 1GHz: 2024/3/6
Test Site:	Chamber A, Chamber B	Test Mode:	Transmitting
Tester:	Joe Li, Bill Yang	Test Result:	Pass

<b>Environmental Conditions:</b>					
Temperature: (°C)	21.2~21.3	Relative Humidity: (%)	56~60	ATM Pressure: (kPa)	100.4~101.4

**Test Equipment List and Details:**

Manufacturer	Description	Model	Serial Number	Calibration Date	Calibration Due Date
9kHz~1000MHz					
Sunol Sciences	Hybrid Antenna	JB3	A060611-1	2023/9/6	2026/9/5
Narda	Attenuator	779-6dB	04269	2023/9/6	2026/9/5
Unknown	Coaxial Cable	C-NJNJ-50	C-1000-01	2023/8/1	2024/7/31
Unknown	Coaxial Cable	C-NJNJ-50	C-0400-04	2023/8/1	2024/7/31
Unknown	Coaxial Cable	C-NJNJ-50	C-0530-01	2023/8/1	2024/7/31
Sonoma	Amplifier	310N	185914	2023/8/1	2024/7/31
R&S	EMI Test Receiver	ESCI	100224	2023/8/18	2024/8/17
EMCO	Adjustable Dipole Antenna	3121C	9109-753	N/A	N/A
Unknown	Coaxial Cable	C-NJNJ-50	C-0200-02	2023/9/4	2024/9/3
Agilent	Signal Generator	E8247C	MY43321350	2023/10/18	2024/10/17
Agilent	MXG Vector Signal Generator	N5182B	MY51350142	2023/9/1	2024/8/31
Above 1GHz					
ETS-Lindgren	Horn Antenna	3115	000 527 35	2023/9/7	2024/9/6
AH	Horn Antenna	SAS-571	1177	2023/2/22	2026/2/22
Xinhang Macrowave	Coaxial Cable	XH750A-N/J-SMA/J-10M	20231117004 #0001	2023/11/17	2024/11/16
AH	Preamplifier	PAM-0118P	469	2023/8/19	2024/8/18
R&S	Spectrum Analyzer	FSV40	101944	2023/10/18	2024/10/17
Agilent	Signal Generator	E8247C	MY43321350	2023/10/18	2024/10/17
Audix	Test Software	E3	191218 (V9)	N/A	N/A
Mini-Circuits	High Pass Filter	VHF-1200+	31102	2023/8/1	2024/7/31
Mini-Circuits	High Pass Filter	VHF-2700A+	31222	2023/12/1	2024/11/30
Mini-Circuits	High Pass Filter	VHF-6010+	31118	2023/12/1	2024/11/30
Ducommun Technologies	Horn Antenna	ARH-4223-02	1007726-02 1304	2023/2/22	2026/2/21
Ducommun Technologies	Horn Antenna	ARH-4223-02	1007726-03 1304	2023/2/22	2026/2/21

\* Statement of Traceability: Bay Area Compliance Laboratories Corp. (Dongguan) attests that all calibrations have been performed, traceable to National Primary Standards and International System of Units (SI).

**Test Data:****SF006A****Lower 700MHz Band Uplink****707 MHz**

Frequency (MHz)	Polar (H/V)	Receiver Reading (dBμV)	Substituted Method			Absolute Level (dBm)	Limit (dBm)	Margin (dB)
			Substituted Level (dBm)	Antenna Gain (dBd/dBi)	Cable Loss (dB)			
1414.00	H	49.52	-67.94	9.07	1.22	-60.09	-19.00	41.09
1414.00	V	50.32	-67.67	9.07	1.22	-59.82	-19.00	40.82
2121.00	H	51.11	-65.32	11.27	1.11	-55.16	-19.00	36.16
2121.00	V	48.78	-67.63	11.27	1.11	-57.47	-19.00	38.47
2828.00	H	50.33	-65.02	13.32	1.36	-53.06	-19.00	34.06
2828.00	V	52.41	-63.17	13.32	1.36	-51.21	-19.00	32.21
3535.00	H	49.44	-62.97	13.91	1.57	-50.63	-19.00	31.63
3535.00	V	50.33	-62.08	13.91	1.57	-49.74	-19.00	30.74
4242.00	H	51.07	-60.11	13.96	1.24	-47.39	-19.00	28.39
4242.00	V	50.63	-60.55	13.96	1.24	-47.83	-19.00	28.83
4949.00	H	49.78	-59.82	13.95	1.45	-47.32	-19.00	28.32
4949.00	V	50.11	-58.86	13.95	1.45	-46.36	-19.00	27.36
210.42	H	75.20	-34.82	0.00	0.20	-35.02	-19.00	16.02
194.90	V	75.17	-31.83	0.00	0.20	-32.03	-19.00	13.03

**Lower 700MHz Band Downlink****737 MHz**

Frequency (MHz)	Polar (H/V)	Receiver Reading (dBμV)	Substituted Method			Absolute Level (dBm)	Limit (dBm)	Margin (dB)
			Substituted Level (dBm)	Antenna Gain (dBd/dBi)	Cable Loss (dB)			
1474.00	H	49.87	-68.99	9.37	1.31	-60.93	-19.00	41.93
1474.00	V	49.36	-69.73	9.37	1.31	-61.67	-19.00	42.67
2211.00	H	50.12	-66.27	10.84	1.15	-56.58	-19.00	37.58
2211.00	V	50.32	-65.97	10.84	1.15	-56.28	-19.00	37.28
2948.00	H	48.69	-65.12	13.95	1.42	-52.59	-19.00	33.59
2948.00	V	49.77	-64.29	13.95	1.42	-51.76	-19.00	32.76
3685.00	H	51.21	-60.75	14.02	1.78	-48.51	-19.00	29.51
3685.00	V	50.24	-61.71	14.02	1.78	-49.47	-19.00	30.47
4422.00	H	49.66	-61.18	13.94	1.79	-49.03	-19.00	30.03
4422.00	V	50.23	-60.47	13.94	1.79	-48.32	-19.00	29.32
5159.00	H	51.38	-56.46	13.96	1.44	-43.94	-19.00	24.94
5159.00	V	50.44	-57.38	13.96	1.44	-44.86	-19.00	25.86
5896.00	H	49.65	-56.73	14.00	1.80	-44.53	-19.00	25.53
204.60	H	75.90	-34.23	0.00	0.19	-34.42	-19.00	15.42
196.84	V	72.97	-33.83	0.00	0.19	-34.02	-19.00	15.02

**Upper 700MHz Band Uplink 781.5 MHz**

Frequency (MHz)	Polar (H/V)	Receiver Reading (dBµV)	Substituted Method			Absolute Level (dBm)	Limit (dBm)	Margin (dB)
			Substituted Level (dBm)	Antenna Gain (dBd/dBi)	Cable Loss (dB)			
1563.00	H	50.10	-68.97	9.88	0.93	-60.02	-46.00	14.02
1563.00	V	49.63	-69.85	9.88	0.93	-60.90	-46.00	14.9
2344.50	H	51.77	-63.86	11.69	1.26	-53.43	-19.00	34.43
2344.50	V	52.32	-63.35	11.69	1.26	-52.92	-19.00	33.92
3126.00	H	49.66	-63.57	13.30	1.76	-52.03	-19.00	33.03
3126.00	V	50.17	-63.07	13.30	1.76	-51.53	-19.00	32.53
3907.50	H	48.55	-62.10	13.45	1.51	-50.16	-19.00	31.16
3907.50	V	49.65	-60.94	13.45	1.51	-49.00	-19.00	30.00
4689.00	H	50.22	-60.89	14.38	1.69	-48.20	-19.00	29.20
4689.00	V	50.37	-60.83	14.38	1.69	-48.14	-19.00	29.14
5470.50	H	51.74	-56.04	13.89	1.30	-43.45	-19.00	24.45
5470.50	V	49.35	-58.31	13.89	1.30	-45.72	-19.00	26.72
196.84	H	75.58	-34.80	0.00	0.19	-34.99	-19.00	15.99
187.14	V	74.41	-33.38	0.00	0.22	-33.60	-19.00	14.60

**Upper 700MHz Band Downlink 751.5 MHz**

Frequency (MHz)	Polar (H/V)	Receiver Reading (dBµV)	Substituted Method			Absolute Level (dBm)	Limit (dBm)	Margin (dB)
			Substituted Level (dBm)	Antenna Gain (dBd/dBi)	Cable Loss (dB)			
1503.00	H	50.10	-69.34	9.52	1.33	-61.15	-19.00	42.15
1503.00	V	49.78	-69.78	9.52	1.33	-61.59	-19.00	42.59
2254.50	H	49.64	-66.35	11.02	1.19	-56.52	-19.00	37.52
2254.50	V	50.12	-65.77	11.02	1.19	-55.94	-19.00	36.94
3006.00	H	48.36	-64.89	13.95	1.52	-52.46	-19.00	33.46
3006.00	V	49.88	-63.56	13.95	1.52	-51.13	-19.00	32.13
3757.50	H	50.01	-61.35	13.77	1.64	-49.22	-19.00	30.22
3757.50	V	51.13	-60.10	13.77	1.64	-47.97	-19.00	28.97
4509.00	H	49.54	-61.40	14.11	1.57	-48.86	-19.00	29.86
4509.00	V	50.26	-60.56	14.11	1.57	-48.02	-19.00	29.02
5260.50	H	51.11	-57.47	14.18	1.30	-44.59	-19.00	25.59
5260.50	V	50.37	-58.29	14.18	1.30	-45.41	-19.00	26.41
204.60	H	75.24	-34.89	0.00	0.19	-35.08	-19.00	16.08
194.90	V	73.75	-33.25	0.00	0.20	-33.45	-19.00	14.45

**Cellular Band Uplink 836.5 MHz**

Frequency (MHz)	Polar (H/V)	Receiver Reading (dBµV)	Substituted Method			Absolute Level (dBm)	Limit (dBm)	Margin (dB)
			Substituted Level (dBm)	Antenna Gain (dBd/dBi)	Cable Loss (dB)			
1673.00	H	48.45	-69.30	10.61	0.73	-59.42	-19.00	40.42
1673.00	V	49.63	-68.72	10.61	0.73	-58.84	-19.00	39.84
2509.50	H	48.27	-68.00	13.11	1.25	-56.14	-19.00	37.14
2509.50	V	50.37	-65.93	13.11	1.25	-54.07	-19.00	35.07
3346.00	H	51.44	-61.41	13.83	1.61	-49.19	-19.00	30.19
3346.00	V	49.62	-63.28	13.83	1.61	-51.06	-19.00	32.06
4182.50	H	52.31	-58.97	13.95	1.56	-46.58	-19.00	27.58
4182.50	V	50.78	-60.49	13.95	1.56	-48.10	-19.00	29.10
5019.00	H	50.22	-59.33	13.98	1.41	-46.76	-19.00	27.76
5019.00	V	49.69	-59.63	13.98	1.41	-47.06	-19.00	28.06
5855.50	H	48.77	-57.98	14.04	1.57	-45.51	-19.00	26.51
5855.50	V	50.27	-56.54	14.04	1.57	-44.07	-19.00	25.07
187.14	H	75.55	-35.31	0.00	0.22	-35.53	-19.00	16.53
202.66	V	73.95	-32.61	0.00	0.18	-32.79	-19.00	13.79

**Cellular Band Downlink 881.5 MHz**

Frequency (MHz)	Polar (H/V)	Receiver Reading (dBµV)	Substituted Method			Absolute Level (dBm)	Limit (dBm)	Margin (dB)
			Substituted Level (dBm)	Antenna Gain (dBd/dBi)	Cable Loss (dB)			
1763.00	H	50.13	-67.53	10.99	0.71	-57.25	-19.00	38.25
1763.00	V	51.05	-67.21	10.99	0.71	-56.93	-19.00	37.93
2644.50	H	49.78	-66.42	13.16	1.28	-54.54	-19.00	35.54
2644.50	V	49.56	-66.85	13.16	1.28	-54.97	-19.00	35.97
3526.00	H	48.33	-64.05	13.88	1.58	-51.75	-19.00	32.75
3526.00	V	49.27	-63.11	13.88	1.58	-50.81	-19.00	31.81
4407.50	H	51.23	-59.59	13.92	1.84	-47.51	-19.00	28.51
4407.50	V	50.41	-60.27	13.92	1.84	-48.19	-19.00	29.19
5289.00	H	50.33	-58.76	14.27	1.19	-45.68	-19.00	26.68
5289.00	V	49.06	-60.11	14.27	1.19	-47.03	-19.00	28.03
191.02	H	75.53	-35.14	0.00	0.21	-35.35	-19.00	16.35
194.90	V	73.90	-33.10	0.00	0.20	-33.30	-19.00	14.30

**PCS Band Uplink****1882.5 MHz**

Frequency (MHz)	Polar (H/V)	Receiver Reading (dB $\mu$ V)	Substituted Method			Absolute Level (dBm)	Limit (dBm)	Margin (dB)
			Substituted Level (dBm)	Antenna Gain (dBd/dBi)	Cable Loss (dB)			
3765.00	H	49.67	-61.63	13.74	1.62	-49.51	-19.00	30.51
3765.00	V	50.21	-60.94	13.74	1.62	-48.82	-19.00	29.82
5647.50	H	51.22	-56.13	14.01	1.31	-43.43	-19.00	24.43
5647.50	V	48.67	-58.56	14.01	1.31	-45.86	-19.00	26.86
7530.00	H	52.34	-49.73	13.20	1.34	-37.87	-19.00	18.87
7530.00	V	50.22	-52.32	13.20	1.34	-40.46	-19.00	21.46
9412.50	H	50.84	-49.30	13.31	1.92	-37.91	-19.00	18.91
9412.50	V	49.69	-51.03	13.31	1.92	-39.64	-19.00	20.64
200.72	H	74.21	-36.00	0.00	0.18	-36.18	-19.00	17.18
179.38	V	74.67	-33.79	0.00	0.24	-34.03	-19.00	15.03

**PCS Band Downlink****1962.5 MHz**

Frequency (MHz)	Polar (H/V)	Receiver Reading (dB $\mu$ V)	Substituted Method			Absolute Level (dBm)	Limit (dBm)	Margin (dB)
			Substituted Level (dBm)	Antenna Gain (dBd/dBi)	Cable Loss (dB)			
3925.00	H	49.66	-61.26	13.55	1.50	-49.21	-19.00	30.21
3925.00	V	50.01	-60.87	13.55	1.50	-48.82	-19.00	29.82
5887.50	H	51.23	-55.23	14.01	1.75	-42.97	-19.00	23.97
5887.50	V	50.46	-56.07	14.01	1.75	-43.81	-19.00	24.81
7850.00	H	48.37	-54.54	13.25	1.58	-42.87	-19.00	23.87
7850.00	V	49.64	-53.46	13.25	1.58	-41.79	-19.00	22.79
196.84	H	75.15	-35.23	0.00	0.19	-35.42	-19.00	16.42
196.84	V	74.18	-32.62	0.00	0.19	-32.81	-19.00	13.81

**AWS-1 Band Uplink 1732.5 MHz**

Frequency (MHz)	Polar (H/V)	Receiver Reading (dBμV)	Substituted Method			Absolute Level (dBm)	Limit (dBm)	Margin (dB)
			Substituted Level (dBm)	Antenna Gain (dBd/dBi)	Cable Loss (dB)			
3465.00	H	48.50	-63.94	13.91	1.62	-51.65	-19.00	32.65
3465.00	V	49.11	-63.37	13.91	1.62	-51.08	-19.00	32.08
5197.50	H	50.34	-57.18	14.00	1.52	-44.70	-19.00	25.70
5197.50	V	49.27	-58.33	14.00	1.52	-45.85	-19.00	26.85
6930.00	H	48.66	-55.30	13.64	1.81	-43.47	-19.00	24.47
6930.00	V	49.27	-54.56	13.64	1.81	-42.73	-19.00	23.73
8662.50	H	51.20	-50.27	13.71	1.88	-38.44	-19.00	19.44
8662.50	V	52.33	-49.49	13.71	1.88	-37.66	-19.00	18.66
202.66	H	74.95	-35.22	0.00	0.18	-35.40	-19.00	16.40
187.14	V	74.50	-33.29	0.00	0.22	-33.51	-19.00	14.51

**AWS-1 Band Downlink 2132.5 MHz**

Frequency (MHz)	Polar (H/V)	Receiver Reading (dBμV)	Substituted Method			Absolute Level (dBm)	Limit (dBm)	Margin (dB)
			Substituted Level (dBm)	Antenna Gain (dBd/dBi)	Cable Loss (dB)			
4265.00	H	50.11	-60.98	13.94	1.04	-48.08	-19.00	29.08
4265.00	V	49.37	-61.74	13.94	1.04	-48.84	-19.00	29.84
6397.50	H	49.57	-55.67	13.60	1.63	-43.70	-19.00	24.70
6397.50	V	51.12	-54.20	13.60	1.63	-42.23	-19.00	23.23
8530.00	H	50.33	-51.45	13.90	1.92	-39.47	-19.00	20.47
8530.00	V	48.64	-53.27	13.90	1.92	-41.29	-19.00	22.29
202.66	H	76.35	-33.82	0.00	0.18	-34.00	-19.00	15.00
196.84	V	74.90	-31.90	0.00	0.19	-32.09	-19.00	13.09



**Model: SF006B**

**Lower 700MHz Band Uplink 707 MHz**

Frequency (MHz)	Polar (H/V)	Receiver Reading (dBμV)	Substituted Method			Absolute Level (dBm)	Limit (dBm)	Margin (dB)
			Substituted Level (dBm)	Antenna Gain (dBd/dBi)	Cable Loss (dB)			
1414.00	H	49.68	-67.78	9.07	1.22	-59.93	-19.00	40.93
1414.00	V	20.17	-97.82	9.07	1.22	-89.97	-19.00	70.97
2121.00	H	51.47	-64.96	11.27	1.11	-54.80	-19.00	35.80
2121.00	V	48.66	-67.75	11.27	1.11	-57.59	-19.00	38.59
2828.00	H	51.79	-63.56	13.32	1.36	-51.60	-19.00	32.60
2828.00	V	52.98	-62.60	13.32	1.36	-50.64	-19.00	31.64
3535.00	H	49.67	-62.74	13.91	1.57	-50.40	-19.00	31.40
3535.00	V	52.37	-60.04	13.91	1.57	-47.70	-19.00	28.70
211.25	H	74.13	-35.88	0.00	0.20	-36.08	-19.00	17.08
193.24	V	73.27	-33.90	0.00	0.20	-34.10	-19.00	15.10

**Lower 700MHz Band Downlink 737 MHz**

Frequency (MHz)	Polar (H/V)	Receiver Reading (dBμV)	Substituted Method			Absolute Level (dBm)	Limit (dBm)	Margin (dB)
			Substituted Level (dBm)	Antenna Gain (dBd/dBi)	Cable Loss (dB)			
1474.00	H	49.85	-69.01	9.37	1.31	-60.95	-19.00	41.95
1474.00	V	49.66	-69.43	9.37	1.31	-61.37	-19.00	42.37
2211.00	H	50.34	-66.05	10.84	1.15	-56.36	-19.00	37.36
2211.00	V	50.84	-65.45	10.84	1.15	-55.76	-19.00	36.76
2948.00	H	50.14	-63.67	13.95	1.42	-51.14	-19.00	32.14
2948.00	V	50.21	-63.85	13.95	1.42	-51.32	-19.00	32.32
3685.00	H	50.35	-61.61	14.02	1.78	-49.37	-19.00	30.37
3685.00	V	50.74	-61.21	14.02	1.78	-48.97	-19.00	29.97
4422.00	H	50.84	-60.00	13.94	1.79	-47.85	-19.00	28.85
4422.00	V	50.31	-60.39	13.94	1.79	-48.24	-19.00	29.24
204.51	H	75.94	-34.20	0.00	0.19	-34.39	-19.00	15.39
196.52	V	72.51	-34.32	0.00	0.19	-34.51	-19.00	15.51

**Upper 700MHz Band Uplink 781.5 MHz**

Frequency (MHz)	Polar (H/V)	Receiver Reading (dBμV)	Substituted Method			Absolute Level (dBm)	Limit (dBm)	Margin (dB)
			Substituted Level (dBm)	Antenna Gain (dBd/dBi)	Cable Loss (dB)			
1563.00	H	51.79	-67.28	9.88	0.93	-58.33	-46.00	12.33
1563.00	V	50.49	-68.99	9.88	0.93	-60.04	-46.00	14.04
2344.50	H	51.37	-64.26	11.69	1.26	-53.83	-19.00	34.83
2344.50	V	52.79	-62.88	11.69	1.26	-52.45	-19.00	33.45
3126.00	H	50.67	-62.56	13.30	1.76	-51.02	-19.00	32.02
3126.00	V	51.47	-61.77	13.30	1.76	-50.23	-19.00	31.23
3907.50	H	50.39	-60.26	13.45	1.51	-48.32	-19.00	29.32
3907.50	V	49.67	-60.92	13.45	1.51	-48.98	-19.00	29.98
4689.00	H	51.37	-59.74	14.38	1.69	-47.05	-19.00	28.05
4689.00	V	51.78	-59.42	14.38	1.69	-46.73	-19.00	27.73
5470.50	H	52.69	-55.09	13.89	1.30	-42.50	-19.00	23.50
5470.50	V	50.73	-56.93	13.89	1.30	-44.34	-19.00	25.34
194.25	H	75.28	-35.23	0.00	0.20	-35.43	-19.00	16.43
188.36	V	74.15	-33.52	0.00	0.21	-33.73	-19.00	14.73

**Upper 700MHz Band Downlink 751.5 MHz**

Frequency (MHz)	Polar (H/V)	Receiver Reading (dBμV)	Substituted Method			Absolute Level (dBm)	Limit (dBm)	Margin (dB)
			Substituted Level (dBm)	Antenna Gain (dBd/dBi)	Cable Loss (dB)			
1503.00	H	50.74	-68.70	9.52	1.33	-60.51	-19.00	41.51
1503.00	V	50.34	-69.22	9.52	1.33	-61.03	-19.00	42.03
2254.50	H	50.81	-65.18	11.02	1.19	-55.35	-19.00	36.35
2254.50	V	50.81	-65.08	11.02	1.19	-55.25	-19.00	36.25
3006.00	H	50.17	-63.08	13.95	1.52	-50.65	-19.00	31.65
3006.00	V	51.33	-62.11	13.95	1.52	-49.68	-19.00	30.68
3757.50	H	49.66	-61.70	13.77	1.64	-49.57	-19.00	30.57
3757.50	V	50.94	-60.29	13.77	1.64	-48.16	-19.00	29.16
4509.00	H	51.31	-59.63	14.11	1.57	-47.09	-19.00	28.09
4509.00	V	50.72	-60.10	14.11	1.57	-47.56	-19.00	28.56
5260.50	H	50.62	-57.96	14.18	1.30	-45.08	-19.00	26.08
5260.50	V	50.14	-58.52	14.18	1.30	-45.64	-19.00	26.64
204.51	H	75.54	-34.60	0.00	0.19	-34.79	-19.00	15.79
194.52	V	73.21	-33.83	0.00	0.20	-34.03	-19.00	15.03

**Cellular Band Uplink 836.5 MHz**

Frequency (MHz)	Polar (H/V)	Receiver Reading (dBμV)	Substituted Method			Absolute Level (dBm)	Limit (dBm)	Margin (dB)
			Substituted Level (dBm)	Antenna Gain (dBd/dBi)	Cable Loss (dB)			
1673.00	H	50.46	-67.29	10.61	0.73	-57.41	-19.00	38.41
1673.00	V	50.98	-67.37	10.61	0.73	-57.49	-19.00	38.49
2509.50	H	50.34	-65.93	13.11	1.25	-54.07	-19.00	35.07
2509.50	V	51.25	-65.05	13.11	1.25	-53.19	-19.00	34.19
3346.00	H	51.78	-61.07	13.83	1.61	-48.85	-19.00	29.85
3346.00	V	50.69	-62.21	13.83	1.61	-49.99	-19.00	30.99
4182.50	H	52.37	-58.91	13.95	1.56	-46.52	-19.00	27.52
4182.50	V	50.14	-61.13	13.95	1.56	-48.74	-19.00	29.74
5019.00	H	50.33	-59.22	13.98	1.41	-46.65	-19.00	27.65
5019.00	V	50.19	-59.13	13.98	1.41	-46.56	-19.00	27.56
184.69	H	74.58	-36.41	0.00	0.23	-36.64	-19.00	17.64
201.59	V	73.29	-33.24	0.00	0.18	-33.42	-19.00	14.42

**Cellular Band Downlink 881.5 MHz**

Frequency (MHz)	Polar (H/V)	Receiver Reading (dBμV)	Substituted Method			Absolute Level (dBm)	Limit (dBm)	Margin (dB)
			Substituted Level (dBm)	Antenna Gain (dBd/dBi)	Cable Loss (dB)			
1763.00	H	50.74	-66.92	10.99	0.71	-56.64	-19.00	37.64
1763.00	V	50.81	-67.45	10.99	0.71	-57.17	-19.00	38.17
2644.50	H	50.94	-65.26	13.16	1.28	-53.38	-19.00	34.38
2644.50	V	50.34	-66.07	13.16	1.28	-54.19	-19.00	35.19
3526.00	H	50.81	-61.57	13.88	1.58	-49.27	-19.00	30.27
3526.00	V	50.51	-61.87	13.88	1.58	-49.57	-19.00	30.57
4407.50	H	50.84	-59.98	13.92	1.84	-47.90	-19.00	28.90
4407.50	V	50.21	-60.47	13.92	1.84	-48.39	-19.00	29.39
5289.00	H	50.94	-58.15	14.27	1.19	-45.07	-19.00	26.07
5289.00	V	50.88	-58.29	14.27	1.19	-45.21	-19.00	26.21
191.52	H	75.64	-35.00	0.00	0.21	-35.21	-19.00	16.21
194.59	V	73.25	-33.78	0.00	0.20	-33.98	-19.00	14.98

**PCS Band Uplink 1882.5 MHz**

Frequency (MHz)	Polar (H/V)	Receiver Reading (dBμV)	Substituted Method			Absolute Level (dBm)	Limit (dBm)	Margin (dB)
			Substituted Level (dBm)	Antenna Gain (dBd/dBi)	Cable Loss (dB)			
3765.00	H	49.67	-61.63	13.74	1.62	-49.51	-19.00	30.51
3765.00	V	50.21	-60.94	13.74	1.62	-48.82	-19.00	29.82
5647.50	H	51.22	-56.13	14.01	1.31	-43.43	-19.00	24.43
5647.50	V	48.67	-58.56	14.01	1.31	-45.86	-19.00	26.86
7530.00	H	52.34	-49.73	13.20	1.34	-37.87	-19.00	18.87
7530.00	V	50.22	-52.32	13.20	1.34	-40.46	-19.00	21.46
9412.50	H	50.84	-49.30	13.31	1.92	-37.91	-19.00	18.91
9412.50	V	49.69	-51.03	13.31	1.92	-39.64	-19.00	20.64
200.19	H	75.24	-34.98	0.00	0.18	-35.16	-19.00	16.16
178.36	V	74.18	-34.18	0.00	0.24	-34.42	-19.00	15.42

**PCS Band Downlink 1962.5 MHz**

Frequency (MHz)	Polar (H/V)	Receiver Reading (dBμV)	Substituted Method			Absolute Level (dBm)	Limit (dBm)	Margin (dB)
			Substituted Level (dBm)	Antenna Gain (dBd/dBi)	Cable Loss (dB)			
3925.00	H	50.49	-60.43	13.55	1.50	-48.38	-19.00	29.38
3925.00	V	50.62	-60.26	13.55	1.50	-48.21	-19.00	29.21
5887.50	H	51.32	-55.14	14.01	1.75	-42.88	-19.00	23.88
5887.50	V	51.25	-55.28	14.01	1.75	-43.02	-19.00	24.02
7850.00	H	51.84	-51.07	13.25	1.58	-39.40	-19.00	20.40
7850.00	V	51.81	-51.29	13.25	1.58	-39.62	-19.00	20.62
9812.50	H	50.34	-49.51	13.49	1.17	-37.19	-19.00	18.19
9812.50	V	50.51	-49.51	13.49	1.17	-37.19	-19.00	18.19
196.54	H	75.42	-34.97	0.00	0.19	-35.16	-19.00	16.16
196.22	V	74.51	-32.36	0.00	0.19	-32.55	-19.00	13.55

**AWS-1 Band Uplink 1732.5 MHz**

Frequency (MHz)	Polar (H/V)	Receiver Reading (dBμV)	Substituted Method			Absolute Level (dBm)	Limit (dBm)	Margin (dB)
			Substituted Level (dBm)	Antenna Gain (dBd/dBi)	Cable Loss (dB)			
3465.00	H	48.75	-63.69	13.91	1.62	-51.40	-19.00	32.40
3465.00	V	50.28	-62.20	13.91	1.62	-49.91	-19.00	30.91
5197.50	H	51.64	-55.88	14.00	1.52	-43.40	-19.00	24.40
5197.50	V	50.38	-57.22	14.00	1.52	-44.74	-19.00	25.74
6930.00	H	50.94	-53.02	13.64	1.81	-41.19	-19.00	22.19
6930.00	V	50.78	-53.05	13.64	1.81	-41.22	-19.00	22.22
8662.50	H	52.67	-48.80	13.71	1.88	-36.97	-19.00	17.97
8662.50	V	52.94	-48.88	13.71	1.88	-37.05	-19.00	18.05
195.31	V	74.19	-32.77	0.00	0.19	-32.96	-19.00	13.96

**AWS-1 Band Downlink 2132.5 MHz**

Frequency (MHz)	Polar (H/V)	Receiver Reading (dBμV)	Substituted Method			Absolute Level (dBm)	Limit (dBm)	Margin (dB)
			Substituted Level (dBm)	Antenna Gain (dBd/dBi)	Cable Loss (dB)			
4265.00	H	51.45	-59.64	13.94	1.04	-46.74	-19.00	27.74
4265.00	V	51.21	-59.90	13.94	1.04	-47.00	-19.00	28.00
6397.50	H	49.85	-55.39	13.60	1.63	-43.42	-19.00	24.42
6397.50	V	49.86	-55.46	13.60	1.63	-43.49	-19.00	24.49
8530.00	H	51.32	-50.46	13.90	1.92	-38.48	-19.00	19.48
8530.00	V	58.99	-42.92	13.90	1.92	-30.94	-19.00	11.94
202.34	H	76.54	-33.64	0.00	0.18	-33.82	-19.00	14.82
196.54	V	74.52	-32.31	0.00	0.19	-32.50	-19.00	13.50

Note 1: The unit of antenna gain is dBd for frequency below 1GHz and is dBi for frequency above 1GHz.

Note 2:

Absolute Level = Substituted Level - Cable loss + Antenna Gain

Margin = Limit - Absolute Level

---

## **APPENDIX A - EUT PHOTOGRAPHS**

---

Please refer to the attachment SSH1240116-03495E-RF-EXP EUT EXTERNAL PHOTOGRAPHS and SSH1240116-03495E-RF-INP EUT INTERNAL PHOTOGRAPHS

---

## **APPENDIX B - TEST SETUP PHOTOGRAPHS**

---

Please refer to the attachment SSH1240116-03495E-RF-00A-TSP TEST SETUP PHOTOGRAPHS.

## APPENDIX C - RF EXPOSURE EVALUATION

### Applicable Standard

According to subpart §1.1310,15.247(i) systems operating under the provisions of this section shall be operated in a manner that ensures that the public is not exposed to radio frequency energy level in excess of the Commission’s guidelines.

Limits for Maximum Permissible Exposure (MPE) (§1.1310, §2.1091)

(B) Limits for General Population/Uncontrolled Exposure				
Frequency Range (MHz)	Electric Field Strength (V/m)	Magnetic Field Strength (A/m)	Power Density (mW/cm <sup>2</sup> )	Averaging Time (minutes)
0.3–1.34	614	1.63	*(100)	30
1.34–30	824/f	2.19/f	*(180/f <sup>2</sup> )	30
30–300	27.5	0.073	0.2	30
300–1500	/	/	f/1500	30
1500–100,000	/	/	1.0	30

f = frequency in MHz; \* = Plane-wave equivalent power density;

According to §1.1310 and §2.1091 RF exposure is calculated.

### Calculation formula:

Prediction of power density at the distance of the applicable MPE limit

$S = PG/4\pi R^2$  = power density (in appropriate units, e.g. mW/cm<sup>2</sup>);

P = power input to the antenna (in appropriate units, e.g., mW);

G = power gain of the antenna in the direction of interest relative to an isotropic radiator, the power gain factor, is normally numeric gain;

R = distance to the center of radiation of the antenna (appropriate units, e.g., cm);

For simultaneously transmit system, the calculated power density should comply with:

$$\sum_i \frac{S_i}{S_{Limit,i}} \leq 1$$



**Calculated Data:**

Mode	Frequency Band (MHz)	Maximum Tune-up Conducted Power (dBm)	Antenna Gain (dBi)	Cable Loss (dB)	Evaluation Distance (cm)	Power Density (mW/cm <sup>2</sup> )	MPE Limit (mW/cm <sup>2</sup> )
Uplink	698-716	21	6.6	1.60	20	0.08	0.465
	776-787	21	6.7	1.70	20	0.08	0.517
	824-849	22	7.1	1.70	20	0.11	0.549
	1710-1755	22	7.9	3.30	20	0.09	1.000
	1850-1915	23	8	2.60	20	0.14	1.000
Downlink	728-746	3	5.57	0.00	20	0.01	0.485
	746-757	1	5.79	0.00	20	0.01	0.497
	869-894	9	5.91	0.00	20	0.01	0.579
	2110-2155	9	7.61	0.00	20	0.01	1.000
	1930-1995	9	6.91	0.00	20	0.01	1.000
2.4G WLAN	2412-2462	20.50	3.26	0.00	20	0.047	1.000
Bluetooth	2402-2480	10.00	3.26	0.00	20	0.004	1.000

Note: the device contains a certified WLAN/Bluetooth module, FCC ID: 2AC7Z-ESPS3WROOM1.

The WLAN/Bluetooth and Downlink are co-location:

$$\sum_i \frac{S_i}{S_{Limit,i}}$$

=S<sub>WLAN</sub>/S<sub>limit-WLAN</sub>+ S<sub>Downlink</sub>/S<sub>limit-Downlink</sub>

=0.047/1+0.01/0.485

=0.068

< 1.0

**Result:** The device meet FCC MPE at 20 cm distance

**\*\*\*\*\* END OF REPORT \*\*\*\*\***