

SUNFORD

A cell booster specially created for the young

SF003

Cell phone booster

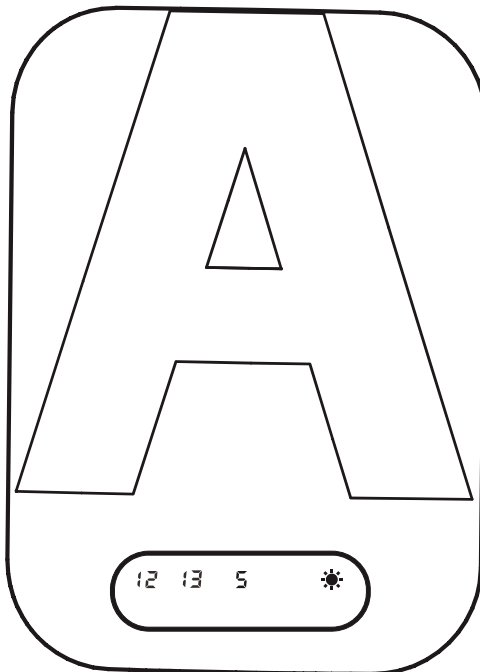

Installation Guide

NEED HELP ?



sunford_after-sales@outlook.com



3-year manufacturer's warranty

CATALOG

Package Contents	1
Preparation	2
STEP 1: Inside Antenna Placement	3
STEP 2: Mount & Point Outside Antenna Toward Nearest Cell Tower	5
STEP 3: Route & Connect Outside Antenna To Booster	10
STEP 3: Route & Connect Inside Antenna To Booster	11
STEP 4: Power Up The Booster & Optimize The System.....	13
Measuring Booster Performance	14
Light Patterns	16
Troubleshooting	17
Safety Guidelines	19
Specifications	20
Warranty	21

Package Contents



Booster
Loft 3L

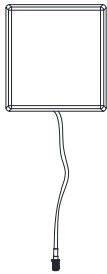

Inside
Antenna

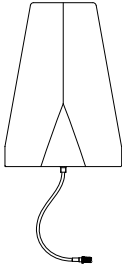

Outside
Antenna

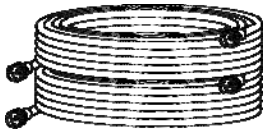

2*30 ft of
3D-FB
Cables

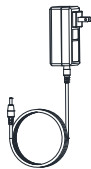

Power
Supply

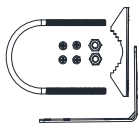

Roof/Pole
Mount
Bracket

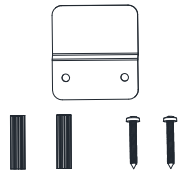

Wall Mount
Bracket

Preparation

You Will Need (tools not included)

Make sure the following materials are prepared and ready for your installation.



1 to 2 hours



2 people (a person to help with antenna calibration)



- ❑ Ladder
- ❑ Drill (if routing cable through wall)
- ❑ 1" -3" diameter existing pole for mounting Outdoor Antenna (Pole Mount can be purchased separately if needed)
- ❑ Recommended: Power Strip with surge protection

NOTE: These instructions will walk you through a “soft” install process to find the optimal locations for the inside and outside antennas, then through the process of the permanent installation.

Step 1: Inside Antenna Placement

Place the **Inside Antenna** where you need the greatest signal boost and place **Booster** in your desired location.

NOTE: Do not connect booster to power until the system is fully installed.

Choose right position for the indoor antenna

- 1 feet away from any other metallic objects
- 3 feet away from any windows

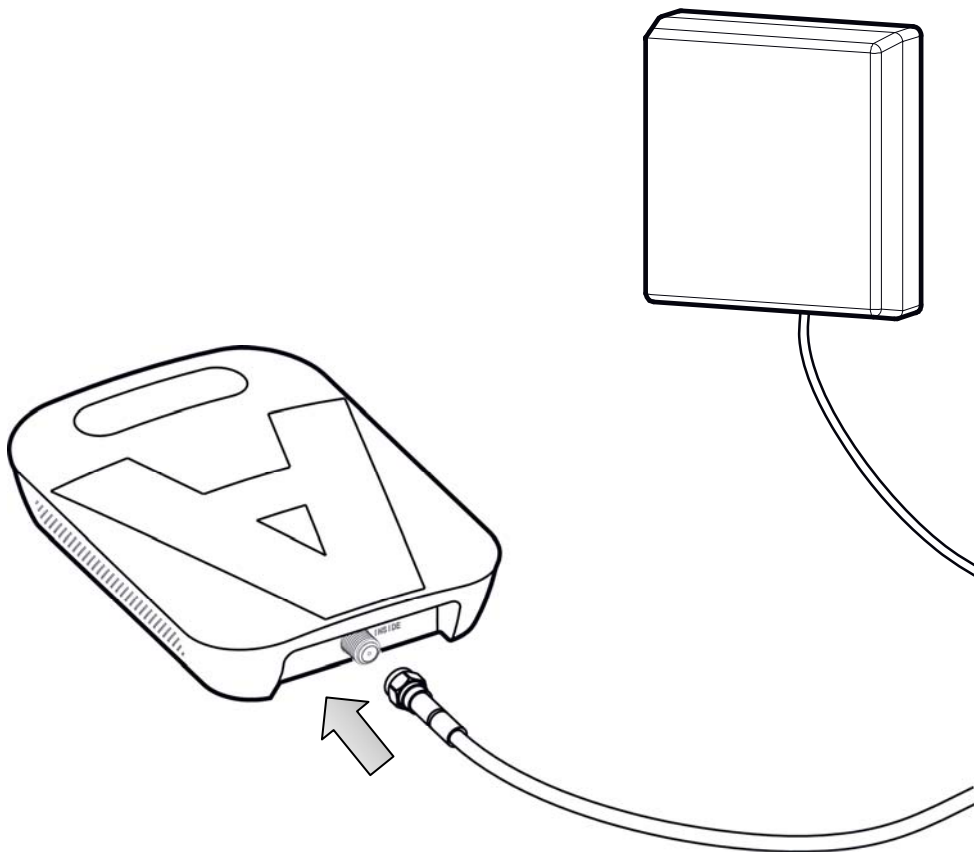



(STEP 1 cont.)

Booster Placement

Mount the **booster**

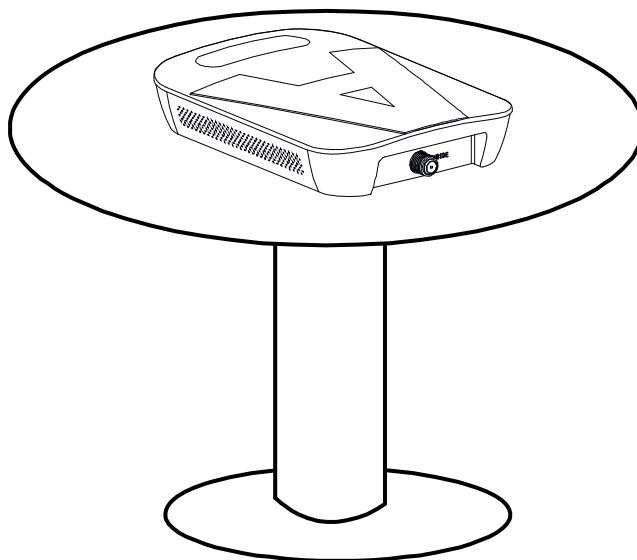
- Choose a ventilated and dry place
- Keep away from heat
- Don't cover booster



 Booster will about 30 degrees Fahrenheit higher than the ambient temperature, which is a normal phenomenon.

Step 2: Mount & Point Outside Antenna Toward Nearest Cell Tower

Pole mounting and wall mounting options are included. The pole mounting option is preferred because it will be easier to adjust to the direction of the cell tower.

Attach the **Mount** to the Outside Antenna and use the **Bracket Clamps** to attach the Antenna to a pole or exhaust pipe.

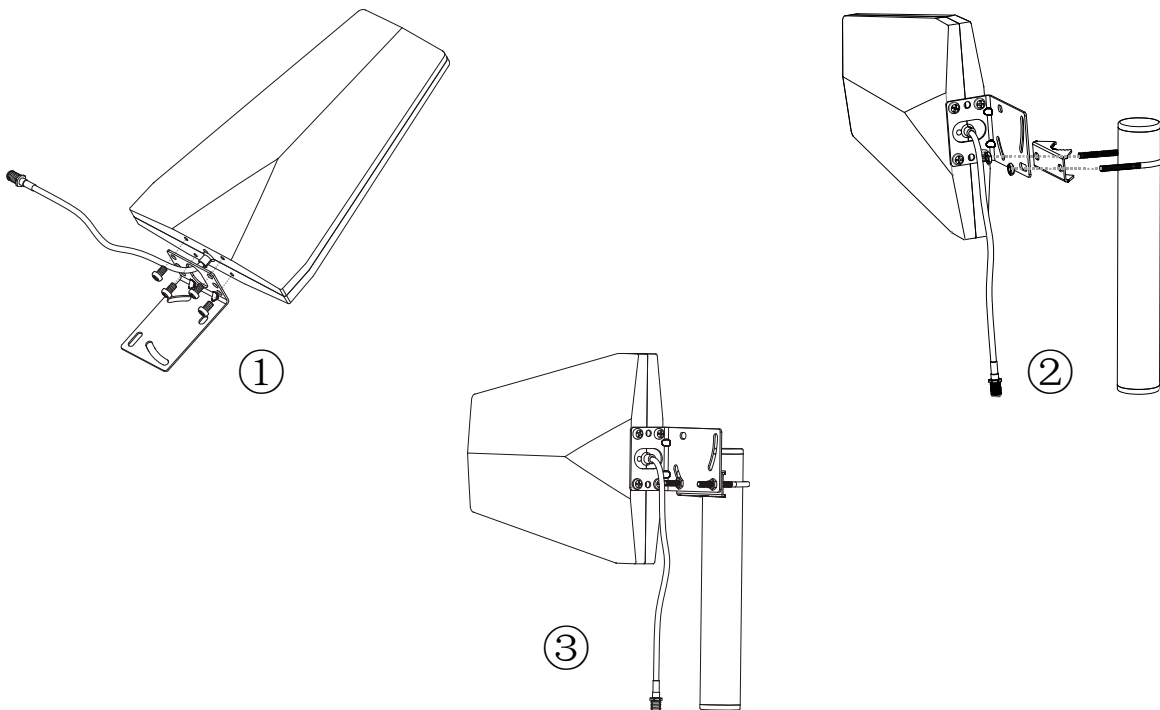

Make sure that the outside unit is mounted at least 3 feet away from any windows.

Outdoor antenna must be installed over the roof line.

NOTE: Mounting on existing roof exhaust pipe would be a good time-saver option. Watch out for power lines.

Point the **Outside Antenna** toward the nearest cell phone tower. To find the nearest tower, use an app such as 'Open Signal'. **This is the most critical step of the installation process because it will determine the overall performance of the booster system.**

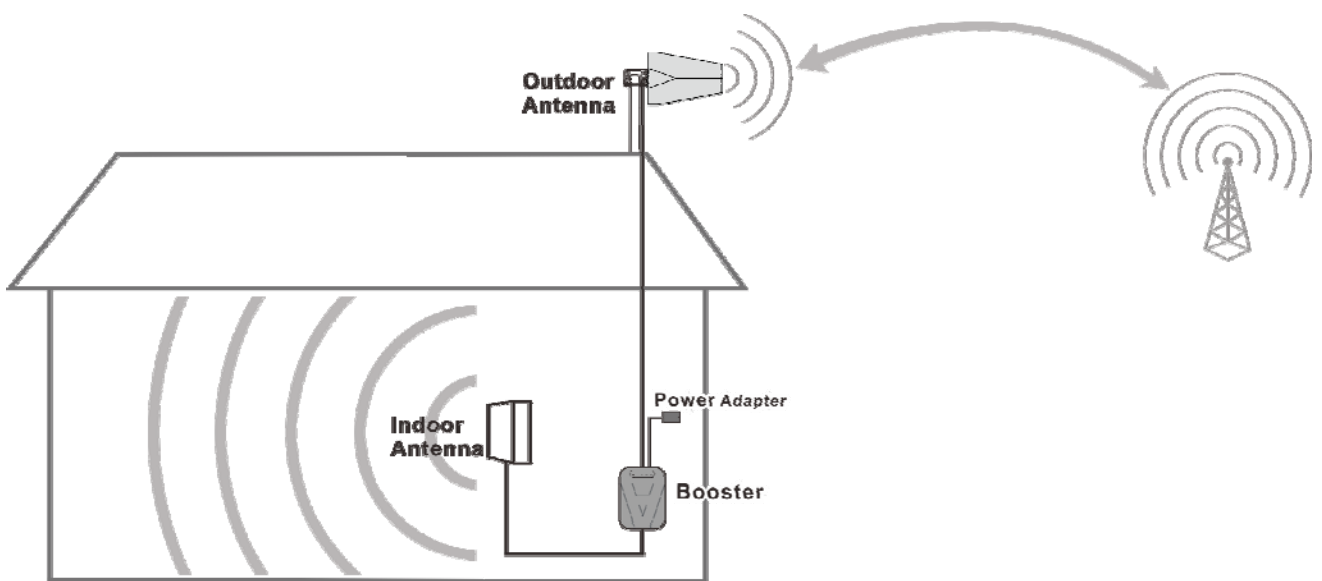

Keep enough distance between outside and inside antenna

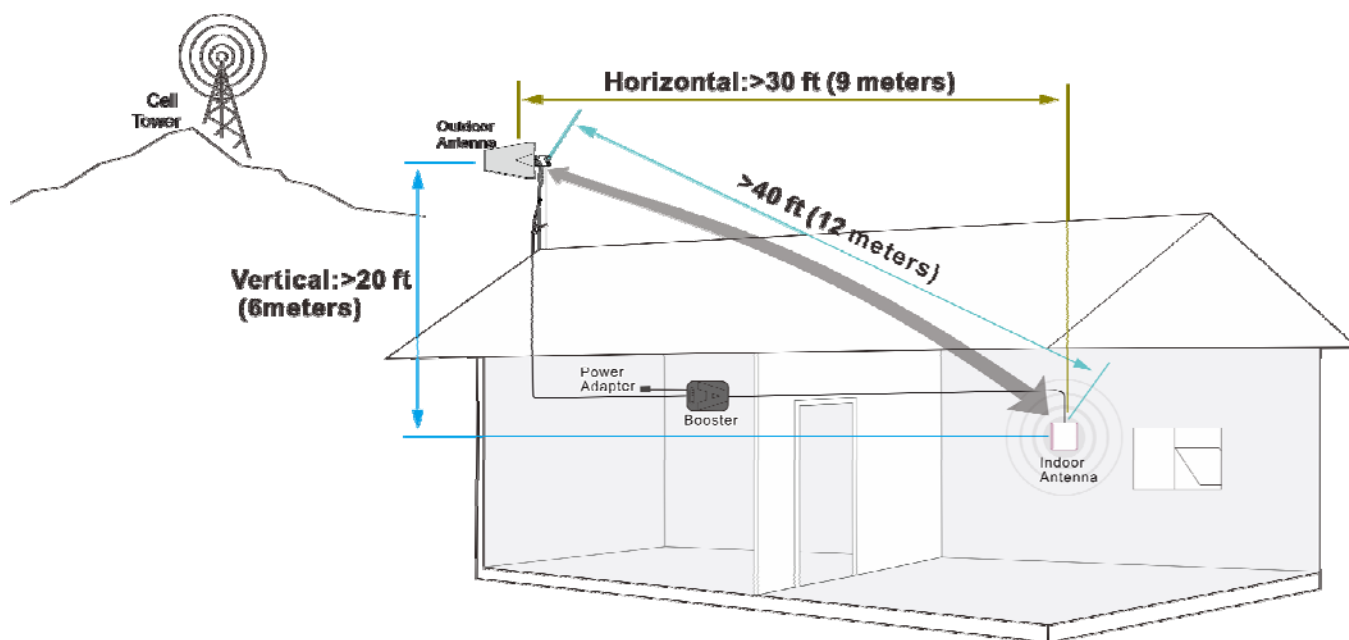

NOTE:

The Outside Antenna must be at least **40 feet** (12 meters) **Straight line distance** or **30 feet** (9 meters) **horizontal** **20 feet** (6 meters) **vertical** from the Inside Antenna for best performance.

The greater the separation between the Inside and Outside Antennas, the better performance you will get from the booster.

Select the optimal mounting location for the outside antenna

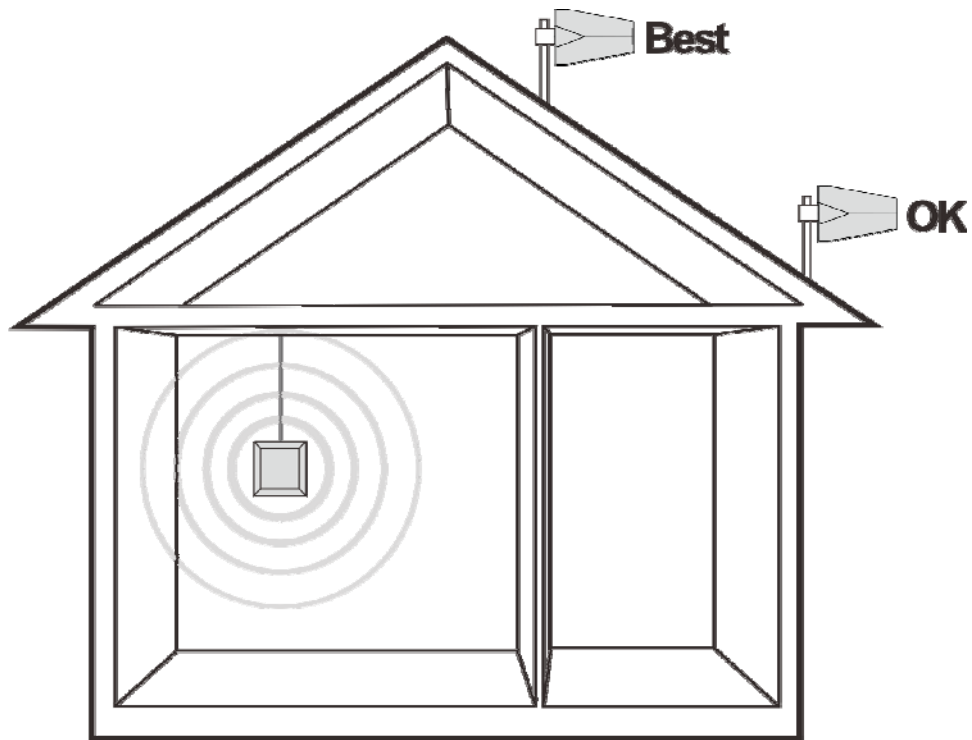

After identifying the area of strongest signal, choose the surface where you will mount your outside antenna.

1. The location should allow for sufficient separation between the outside antenna and inside antenna.
2. In order to better receive external signals, the outside antenna is best installed in a higher position on the house, but please pay attention to lightning protection.

Antenna mutual position

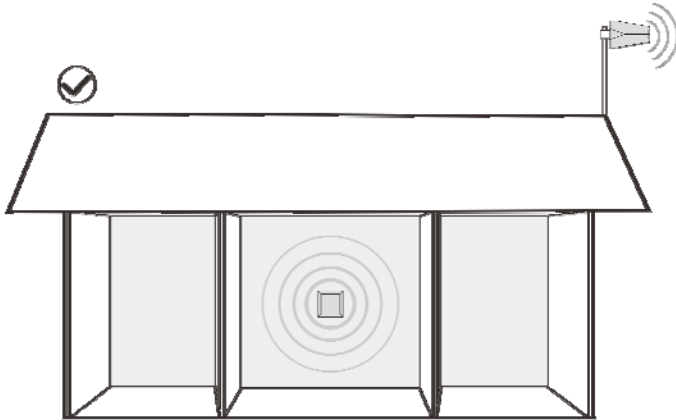

The outside antenna should be oriented in a way that it does not “face” the inside antenna.

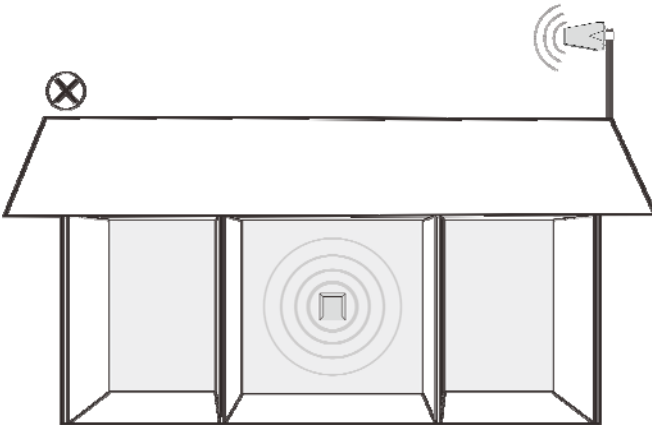

Caution: Do not aim an outside antenna towards inside antenna.

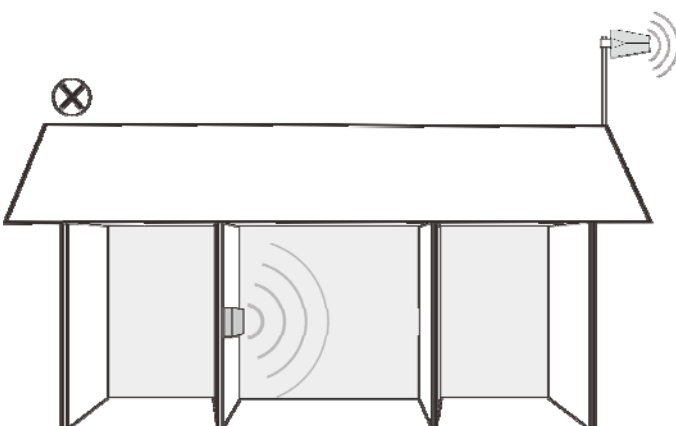

Caution: The inside antenna cannot face the outside antenna.

Step 3: Route & Connect Outside Antenna To Booster

Connect the white **3D-FB Cable** to **Outside Antenna** and route cable into the home, secure the cable near the antenna. All connections should be **finger tightened** only.

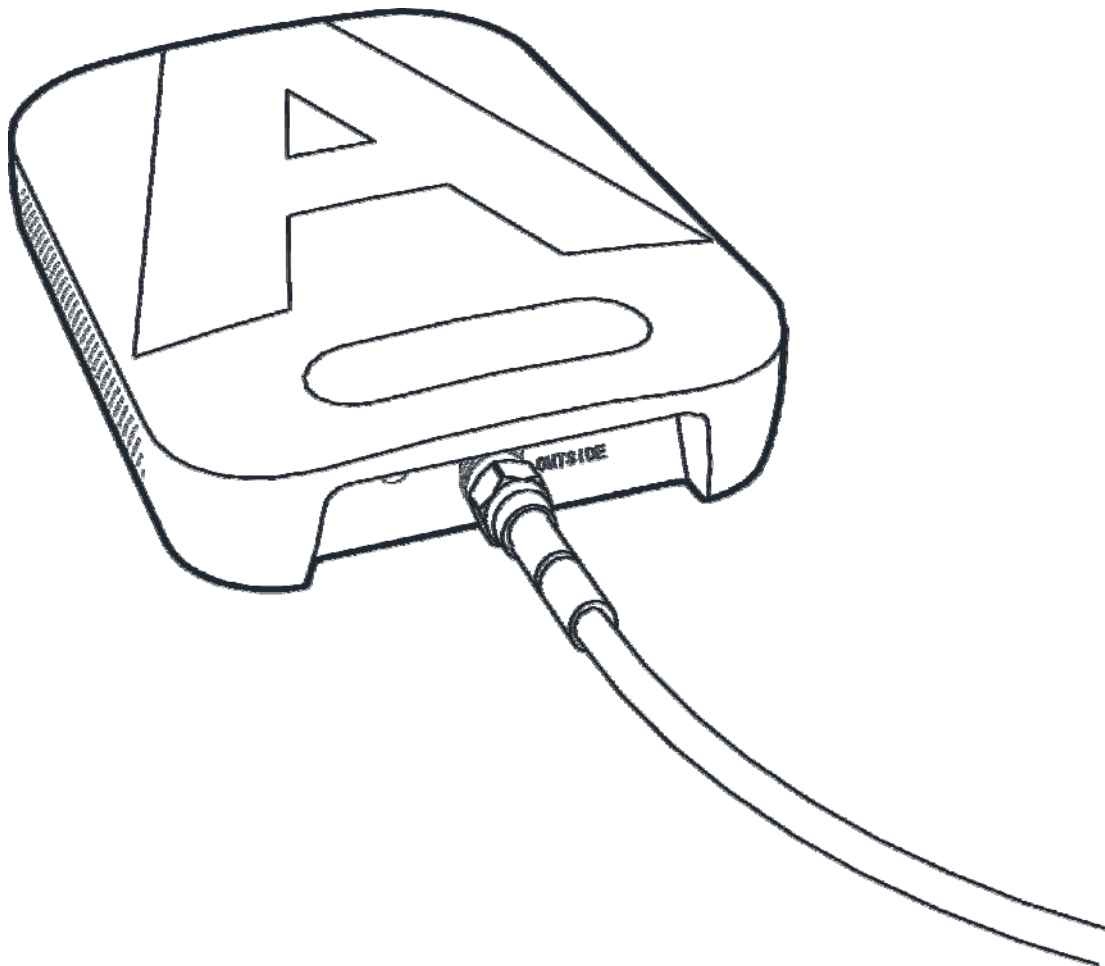

Route cable to the **Booster** and connect to the port labeled 'OUTSIDE'.

Step 3: Route & Connect Inside Antenna To Booster

Connect the **Inside Antenna** to the 'INSIDE' port on the **booster**.

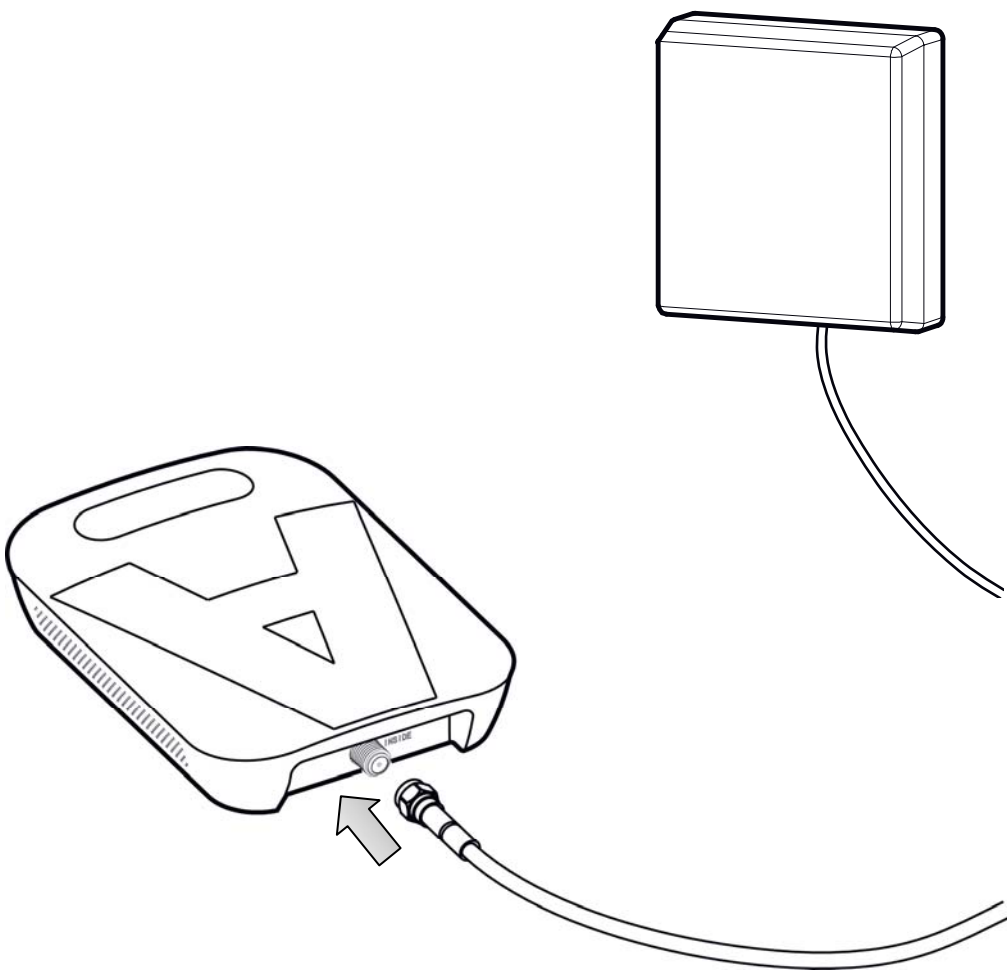

(STEP 3-A cont.)

Wall Mounting Option

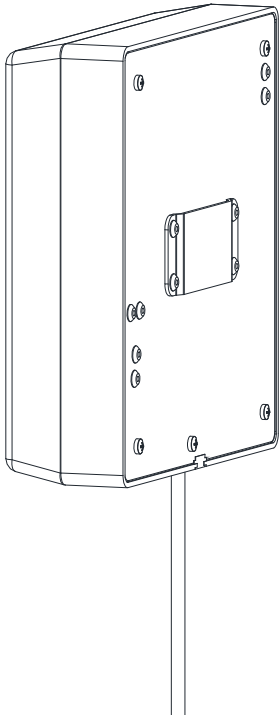

Fasten bracket to back of Inside Antenna

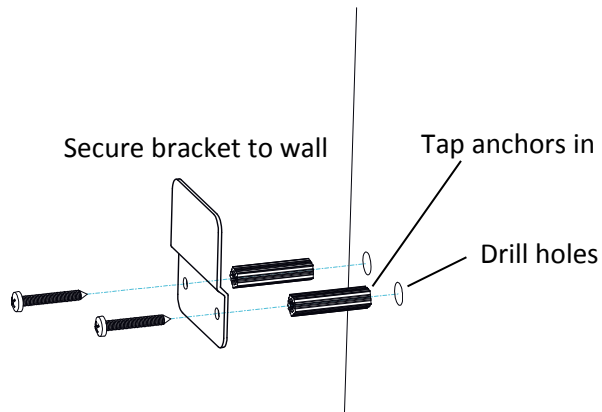

Mounting Inside Antenna on wall bracket

sideview

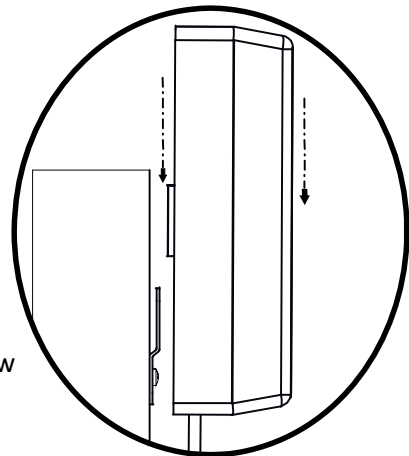

Step 4: Power Up The Booster & Optimize The System

Plug in the **Power Supply** and connect it to the nearest power outlet.

NOTE: We strongly recommend using a power strip with surge protection.

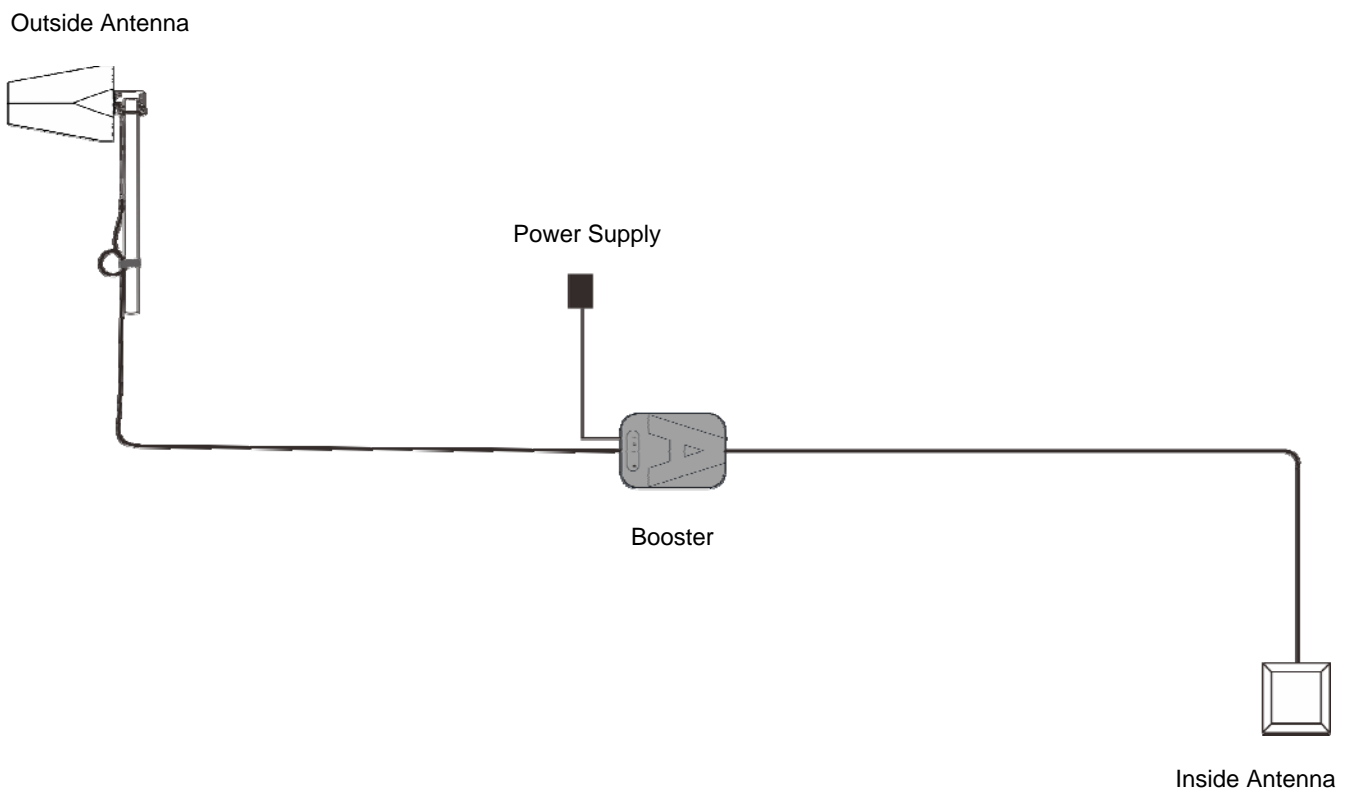

Measuring Booster Performance

How To Get Signal Strength As A Number

iPhone®

Dial *3001#12345#* then press Call.

1 Hold down power button until you see 'Slide to Power Off'.

2 Then release the power button.

3 Hold the Home button until your main screen appears.

If you want to check 3G/1x but your iPhone is picking up 4G/LTE signal, go to Settings>Cellular>Cellular Data Options>En_x0002_able .LTE>Select Off.

After you system is set up, you can go back to the dots signal by once again dialing *3001#12345#* then pressing call.

When the menu comes back up, tap “phone” in the top left corner of your phone.

iPhone®

iOS 11 - current

iOS 11 and later no longer displays the decibel (dBm) reading in 'Field Test Mode'. Tip: Using the dot signal strength indicator on your cell phone can assist you in finding the strongest signal direction as well as placing calls in different locations.

Android™

Settings > About Phone > Status or Network > Signal Strength or Network Type and Strength (exact options/wording depends on phone model).

Android: download third part APP-LTE Discovery

iPhone is a registered trademark of Apple Inc. Android is a trademark of Google Inc.

How To Confirm That Your Installation Is Correct And Effective?

Having an accurate measurement of signal strength in decibels (dBm) is crucial when installing your system. Decibels accurately measure the signal strength you are receiving.

(MEASURING BOOSTER PERFORMANCE AFTER INSTALLATION cont.)

Signal strength at 6 feet from indoor antenna

Note here: _____ dBm

Signal strength at 6 feet from outdoor antenna

Note here: _____ dBm

Compare Results

If the signal strength in decibels (dBm) at 6 feet from the indoor antenna is 15-20dB higher than the signal strength at 6 feet from the outdoor antenna, then your system has achieved the optimum results.

Note: Since it is a negative number, the smaller the number, the greater the signal strength.

DID YOU KNOW a signal increase of just 3dB is 2 times the power and signal amplification!

Light Patterns

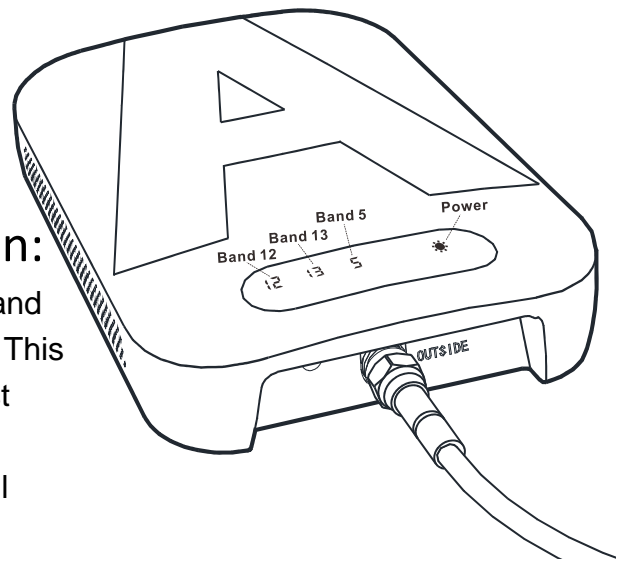

Band Indicator Lights Solid Green:

- Every time the power is powered on, all the band indicators will turn orange for about 1 second. This indicates your booster has passed the self-test and is in good condition. When the booster is functioning properly, all the band indicators will remain solid green during operation.

DC Power Indicator Correct Functioning:

- Power Light should be solid green after powered on.

Band Indicator Lights Blinking Red:

- Band has reduced gain. Which lights blinking indicate that the corresponding bands have reduced power due to a feedback loop condition called oscillation. This is a built in safety feature to prevent harmful interference with a nearby cell tower. If you are already experiencing the desired signal boost, then no further adjustments are necessary. If you are not experiencing the desired boost in coverage then refer to the Troubleshooting section.

Band Indicator Lights Solid Red:

- Band has shutoff. This is due to a feedback loop condition called oscillation. This is a built in safety feature that causes a band to shut off to prevent harmful interference with a nearby cell tower. Refer to Troubleshooting section.

DC Power Indicator Off:

- Please check your outlet, make sure it is normal.

Troubleshooting

IF YOU ARE HAPPY WITH THE COVERAGE, THESE LIGHT ISSUES DON'T HAVE TO BE RESOLVED. YOUR CARRIER'S BAND HAS NOT BEEN AFFECTED.

FIXING ANY BAND INDICATOR LIGHTS BLINKING RED ISSUES

Band Indicator Lights Blinking Red

1. Band Indicator Lights Blink 1 To 15 Times (1 cycle) Then Turn Green
That means the gain lowered 1~15 dB. If your coverage is good and reception is good, you can ignore the blink; If you would like greater coverage and better reception, please increase the distance between the outside antenna and inside antenna to improve the gain.

2. Band Indicator Lights Blink All The Time

That means the gain lowered 16~25 dB. Please increase the distance (horizontally or vertically) between the outside and inside antenna to solve the oscillation problem. Check and install the whole system again.

FIXING ANY BAND INDICATOR LIGHTS SOLID RED ISSUES

Band Indicator Lights Solid Red

That means shut down. Please increase the distance (horizontally or vertically) between the outside and inside antenna to solve the oscillation problem. Unplug and re-plug in power supply. Check and install the whole system again.

How to solve the problem of oscillation:

1. Keep enough distance between inside and outside antenna

Minimum Required Separation Distance Between Inside and Outside Antenna:

Straight line distance over **40 feet**(12 meters) or

30 feet (9 meters) **horizontal** distance

20 feet (6 meters) **vertical** distance (as far as possible).

2. Verify outside and inside antenna face away from each other.

3. You may need to undo and redo the connection completely. Un-plug and re-plug in power supply.

FIXING ANY BAND INDICATOR LIGHTS SOLID ORANGE ISSUES

Band Indicator lights Solid Orange

That means corresponding band has shutoff due to interference from other band signals.

Outside antenna need to be adjusted.

Pole Mount Option: Rotate the outside antenna away from the strongest cellular signal in small increments(45°). Then power on again and to see if the band indicator light is solid green.

Mounting on side of roof option: Change mount location or increase the distance between the outside and inside antenna. Move the outside antenna to location of the home/building. Then power on again and to see if the band indicator light is solid green. Then secure in place.

FIXING DC POWER INDICATOR OFF ISSUES

Please verify your power supply has power;

Please verify the power cord is tightened;

Contact with us by email or call for replacement.

Safety Guidelines

To uphold compliance with network protection standards, all active cellular devices must maintain at least six feet of separation distance from inside unit antenna and outside unit antenna and at least four feet of separation distance from inside unit.

Use only the power supply provided in this package. Use of a non-SunFord product may damage your equipment.

The Signal Booster unit is designed for use in an indoor, temperature-controlled environment (less than 100 degrees Fahrenheit). It is not intended for use in attics or similar locations subject to temperatures in excess of that range.

RF Safety Warning: Any antenna used with this device must be located at least 8 inches from all persons.

This is a **CONSUMER** device

BEFORE USE, you **MUST REGISTER THIS DEVICE** with your wireless provider and have your provider's consent. Most wireless provider consent to the use of signal boosters. Some providers may not consent to the use of this device on their network. If you are unsure, contact your provider.

In Canada, **BEFORE USE** you must meet all requirements set out ISED CPC-2-1-05.

You **MUST** operate this device with approved antenna and cables as specified by the manufacturer. Antennas **MUST** be installed at least 20cm (8inches) from (i.e., **MUST NOT** be installed within 20 cm of) any person.

You **MUST** cease operating this device immediately if requested by the FCC (or ISED in Canada) or a licensed wireless service provider.

WARNING. E911 location information may not be provided or may be inaccurate for calls served by using this device.

This device may be operated **ONLY** in a fixed location (i.e., may operate in a fixed location only) for in-building use.

FOR MORE INFORMATION ON REGISTERING YOUR SIGNAL BOOSTER WITH YOUR WIRELESS PROVIDER, PLEASE SEE BELOW:

Sprint:	http://www.sprint.com/legal/fcc_boosters.html
T-Mobile/MetroPCS:	https://support.t-mobile.com/docs/DOC-9827
Verizon Wireless:	http://www.verizonwireless.com/wcms/consumer/register-signal-booster.html
AT&T:	https://securec45.securewebsession.com/attsignalbooster.com/
U.S. Cellular:	http://www.uscellular.com/uscellular/support/fcc-booster-registration.jsp

Specifications

Model Number	SF003		
Connectors	F-Female on the Inside Antenna / F-Female on the Outside Antenna		
Noise figure	5 dB nominal		
Antenna Impedance	75 Ohms / 75 Ohms		
Weight	0.35Kg		
Frequency	698-716MHz, 776-787MHz, 824-849MHz 728-746MHz, 746-757MHz, 869-894MHz		
Power output for single cell phone (Uplink)dBm	700A-MHz Band12 60	700MHz Band13 60	800MHz Band5 62
Power output for single cell phone (Downlink)dBm	700A-MHz Band12 62	700MHz Band13 62	800MHz Band5 65
EIRP	1W Max		
Operating temperature	5°F to 140°F (-15°C~60 °C)		
Isolation	>110 dB		
Power Requirements	AC / DC 12V,1.5A, w/1.35X3.5mm Jack		

This device complies with Part 15 of FCC rules. Operation is subject to two conditions: (1) This device may not cause harmful interference, and (2) this device must accept any interference received, including interference that may cause undesired operation. Changes or modifications not expressly approved by SunFord could void the authority to operate this equipment.

CPC-2-1-05 — Zone Enhancers - Spectrum management and telecommunications <http://www.ic.gc.ca/eic/site/smt-gst.nsf/eng/sf08942.html>

Warning:Unauthorized antennas/cables and/or coupling devices are prohibited by FCC rules. Please contact FCC for details: 1-888-CALL-FCC

NEED HELP ?

 sunford_after-sales@outlook.com

(EN) This device complies with Industry Canada license-exempt RSS standard(s). Operation is subject to the following two conditions: (1) this device may not cause interference, and (2) this device must accept any interference, including interference that may cause undesired operation of the device.

(FR) Le présent appareil est conforme aux CNR d'Industrie Canada applicables aux appareils radio dispense de permis. L'exploitation est autorisée aux deux conditions suivantes : (1) l'appareil ne doit pas produire de brouillage, et (2) l'utilisateur de l'appareil doit accepter tout brouillage radioélectrique subi, même si le brouillage est susceptible d'en compromettre le fonctionnement.



3 YEAR WARRANTY

The Booster is covered under a three-year product warranty for failures or defects that result from craftsmanship and/or materials. Dated proof of purchase should be retained for use in warranty cases. Contact the retailer/reseller directly with any warranty issues, or alternatively contact the manufacturer in cases where the reseller is no longer available to handle warranty claims. In cases where the reseller is unavailable, the product may be returned to the manufacturer at the consumer's expense, with a dated proof of purchase and a return authorization letter which can be attained by contacting SunFord.

This warranty does not apply to any signal booster components determined by SunFord to have been subjected to misuse, abuse, neglect, tampering, or mishandling that result in damages to the physical or electronic properties of the product. Refurbished products that have been recertified to conform to product specifications may be used for product replacements.

DISCLAIMER: The information provided by SunFord is believed to be complete and accurate, to the best of our knowledge. However, no responsibility is assumed by SunFord for any business or personal losses arising from the use of the information herein contained, or for any infringements of patents or other rights of third parties that may result from its use.

NEED HELP ?

 sunford_after-sales@outlook.com

Antenna Kitting Information

Component	Prod No. Description	Gain/Loss		Notes
		LTE-A/LTE-V 700MHz	800MHz	
Outdoor Antenna	A-SF001	8dBi	8dBi	Log Periodic Antenna (Default)
	A-SF002	3dBi	3dBi	Omni Directional Antenna
Outdoor Cable	RG660Feet	4dB	4.3dB	60 feet
Outdoor Cable	3D-FB60Feet	4.5dB	5.4dB	60 feet (Default)
Outdoor Cable	3D-FB30Feet	2.1dB	2.5dB	30 Feet
Indoor Cable	3D-FB30Feet	2.1dB	2.5dB	30 Feet
Indoor Cable	RG630Feet	1.8dB	1.9dB	30 feet
Indoor Antenna	A-SF003	8dBi	8dBi	Panel Antenna
	A-SF004	2dBi	2dBi	Whip Antenna (Default)
*All equivalent antennas and cables are suitable for use with the xxx				

Notes

SUNFORD

A cell booster specially created for the young



NEED HELP ?



sunford_after-sales@outlook.com
