



Tabasco



User Manual

Table of Contents

1 Your Device	3
1.1 Overview.....	3
1.2 Setting up your phone.....	5
1.3 Power on your phone.....	7
1.4 Power off your phone.....	7
2 Phone call	7
2.1 Making a Call.....	7
2.2 Answering or rejecting a call.....	9
2.3 Hang up a call	9
3 Contacts	10
3.1 Add a Contact	10
3.2 View a Contact.....	10
3.3 Edit a Contact.....	10
3.4 Share a Contact	11
3.5 Delete Contacts.....	11
3.6 Import/Export Contacts	11
4 Messages	12
4.1 Sending a Text Message.....	12
4.2 Sending a Multimedia Message	12
5 Camera	13
5.1 Access the Camera	13
5.2 Take a picture.....	13
5.3 Zoom in/out	13
5.4 Access the Video.....	13
6 Browser	13
7 Multimedia	13
7.1 Picture.....	13
7.2 Music.....	14
7.3 Video	14
7.4 FM Radio	14
7.5 Sound Recorder.....	14
8 Tools	15

8.1	Calendar.....	15
8.2	Calculator	15
8.3	Clock	16
9	Applications	17
9.1	E-Mail	17
9.2	File Manager	17
9.3	Note	18
10	Setting.....	18
10.1	Wireless & Network	18
10.2	APPs	20
10.3	Sounds	20
10.4	Display.....	20
10.5	Battery	21
10.6	Storage.....	21
10.7	Accessibility	22
10.8	Privacy & Security.....	22
10.9	Software Update.....	22
10.10	System	22
11	Safety and Precautions	23
11.1	Device Precautions	23
11.2	Battery Precautions	24
11.3	FCC Notice and Cautions	24
11.4	Consumer Information on SAR	25
11.5	FCC Hearing-Aid Compatibility (HAC) Regulations for Wireless Devices	26
11.6	Copyright Information	26

1 Your Device

1.1 Overview

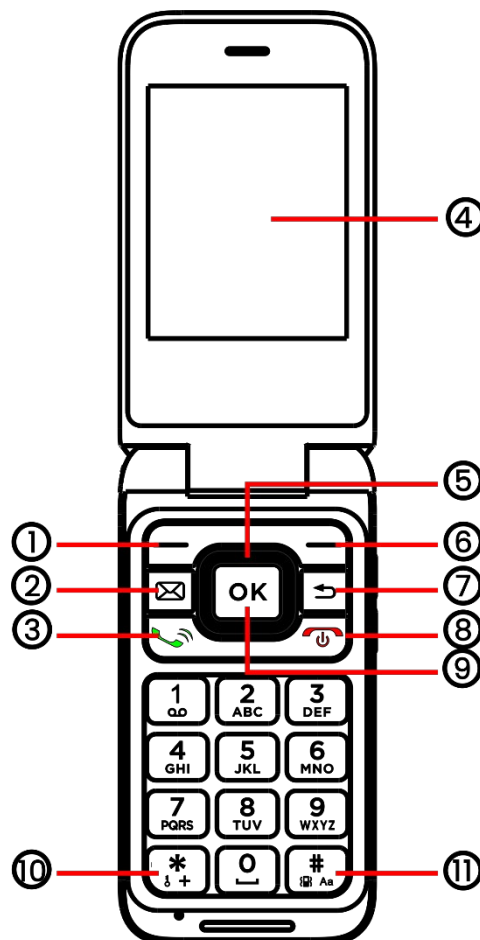
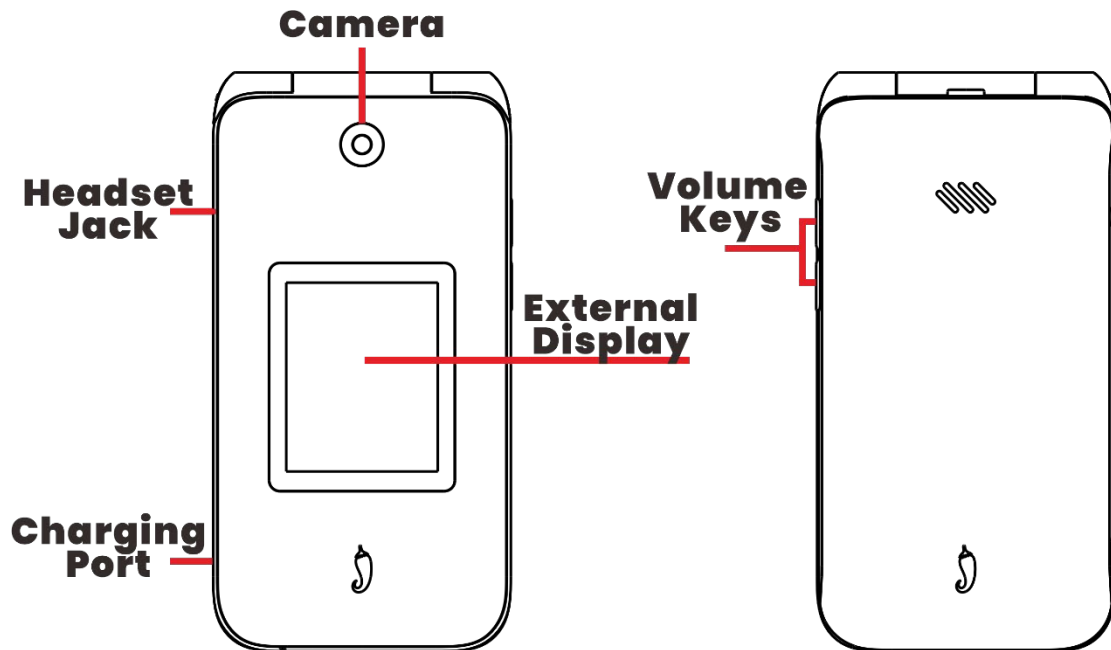

(1) Left Soft Key

- Press: to access Notifications
- Multi-functions in different scene

(2) Messages

- Press: access messages

(3) Call Key

- Make a call
- Press: Enter call log (from Idle screen)

(4) Internal display

(5) Navigation Key (up, down, left, right)

- Menu selection moves up, down, left, and right
- Press Right: Access Camera / Video

(6) Right Soft Key

- Press: Access Contacts
- Press: Access Options

(7) Back/Delete Key

- Move backwards through Menus
- Delete input unnecessary



(8) End/Power Key

- Press: End a call, return to the main screen
- Press and hold to Power on/off

(9) Center Soft Key

- Confirm and select an option (press OK key)
- Press: Access app list (from home screen)

(10) Key symbols

- Press  then choose a symbol. Press the **Center Soft Key**  to Lock the device.

(11) Letters symbols

- In home screen, press  to switch vibrating mode

- In the input interface, press  to switch between with number, letter, capital, lowercase,

1.2 Setting up your phone

Your phone actually doesn't have any NANO SIM card installed. MicroSD cards (up to 128GB) excluded as well.

NOTE: Power off the device before opening the back cover to install a microSD or replace the NANO SIM card.

Step 1. With the device facing down, remove the back cover from the bottom left corner. Use your fingernail to carefully lift the cover away from the device body.

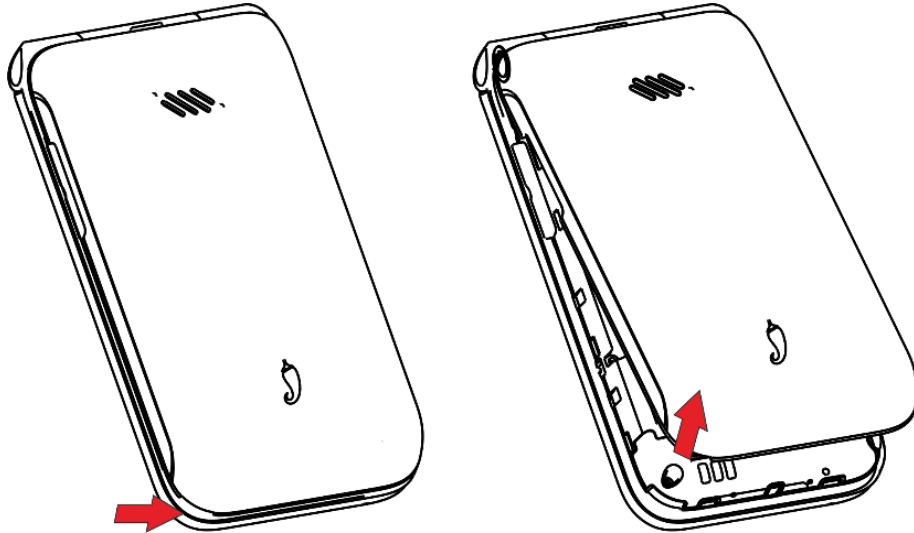

Step 2. Remove the battery using your fingernail to lift from the top.

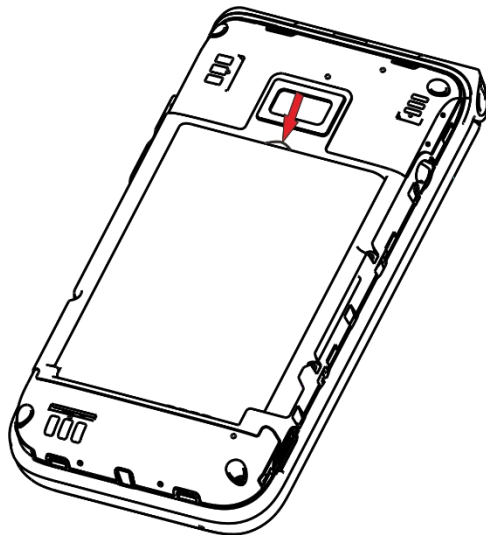

Step 3. To insert SIM card or microSD card, push the SIM card or microSD card into the card slot with the gold-colored contacts facing down.

To remove the SIM card or microSD card, press down on the small plastic tab, then slide out the card. Do not use force or any sharp objects.

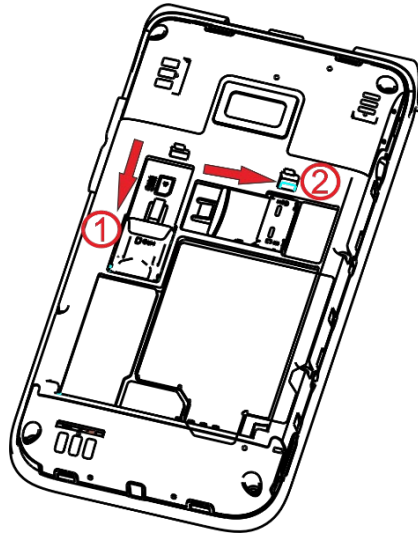

Step 4. Re-install the battery by aligning the gold contact points of the battery with the gold contact points of the cave. It only fits one way. Press down to snap in place.

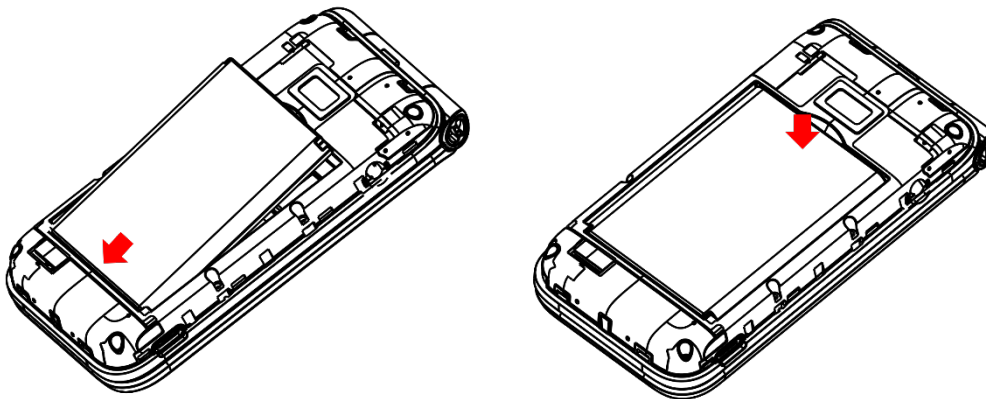

Step 5. Carefully align the back cover with tabs and press into place. It only fits one direction.

Step 6. Charge your phone fully before turning it on and starting the set-up

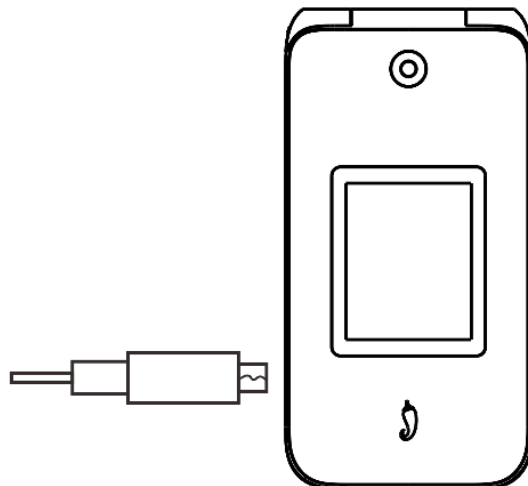

process.

WARNING: Only use the charger and cable supplied with the phone. Using incompatible chargers or tampering with the charging port could damage your phone.

1.3 Power on your phone

Press and hold the **End/Power Key**  until the phone powers on.
Setup your phone for the first time

The first time you power on the phone, you will be guided through the following few steps. All the setting you didn't see can be done in Setting personally:

- Select the phone's language, then press the **Right Soft Key**  to go to the next step.
- Then enter the home screen.

Note: Even if no SIM card is installed, your phone will still power on and you will be able to connect to a Wi-Fi network and use some of the phone's features.

1.4 Power off your phone

Press and hold the **End/Power Key**  until the phone has a vibration and then device power off immediately.

2 Phone call

2.1 Making a Call

Dial the desired number then press the **Call Key**  to make the call. If you make a mistake, you can delete the incorrect digits by pressing the **Back/Delete Key** .

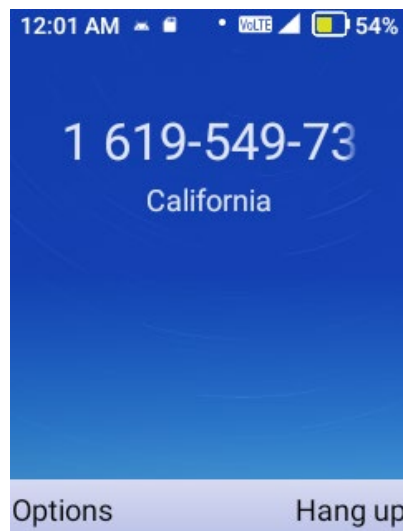



Press the **Left Soft Key**  to call

Press the **Right Soft Key**  to show more Options

1. Create new contact
2. Add to a contact
3. Send a message
4. Settings
5. Add 2-sec pause
6. Add wait
7. Call history

a) Make a call from your call log

From the Home screen, press the **Call Key** .

> Call Log to access the call log and choose the contact you want to dial, press the **Call Key** .



b) Make a call from Contacts

From the Home screen, press the **Right Soft Key** , Choose the contact you want to dial, press the **Call Key** .

c) Making an emergency call

If your phone has network coverage, dial emergency number and press the **Call Key**  to make an emergency call. This works even without a SIM card and without typing the PIN code.



d) Make an international call

To dial an international call, press and hold  to enter “+” in dial screen, enter the international country prefix followed by the full phone number, then press the **Call Key** .

e) Calling your voicemail

Press and hold  key to call and listen to your voicemail.

f) Setting up voice mail

1. Dial *86 and press the **Call Key** .
2. When you hear a greeting, press  to interrupt.
3. Follow the setup instructions.

g) Checking voice mail

From your phone:

1. Dial *86 and press the **Call Key** .
2. Follow the instructions.

From other phones:





1. Dial your wireless number.
2. When you hear the greeting, press  to interrupt.
3. Follow the instructions. Contact your network operator to check service availability.

NOTE: Voice mailboxes not set up within 45 days will be canceled. Your voice mailbox is not password protected until you create a password by following the setup tutorial. Voice mail may not be available in some areas. Follow the setup instructions to password protect your voice mailbox.

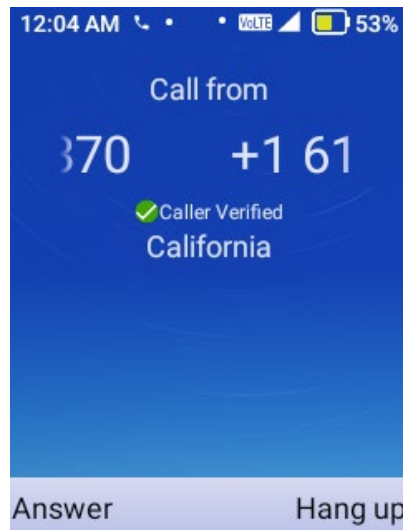
2.2 Answering or rejecting a call

During an incoming call:



- Open the flip to answer, Flip open to answer is On. Otherwise,
- Press the **Left Soft Key**  or **Call Key**  to answer.
- Press the **Right Soft Key**  or the **End/Power Key**  to Hang up.
- Press the **Center Soft Key**  to reject the call by sending a preset message.
- To mute the ringtone volume of an incoming call, press the Volume Up/Down Key.

2.3 Hang up a call

During a call:

- Open the flip and press the **End/Power Key**  to end the call.
- Open the flip and close the flip to end the call.

3 Contacts

Contacts enables quick and easy access to the contact you want to reach.

From the Home screen, press the **Center Soft Key**  and select Contacts to enter Contact list.

3.1 Add a Contact

On the contacts list screen, use the **Navigation Key** and press the **Left Soft Key** to make a call. Press **Left Soft Key** , to create a New Contact and input the contact information.

When finished, press the **Left Soft Key** to save.

3.2 View a Contact

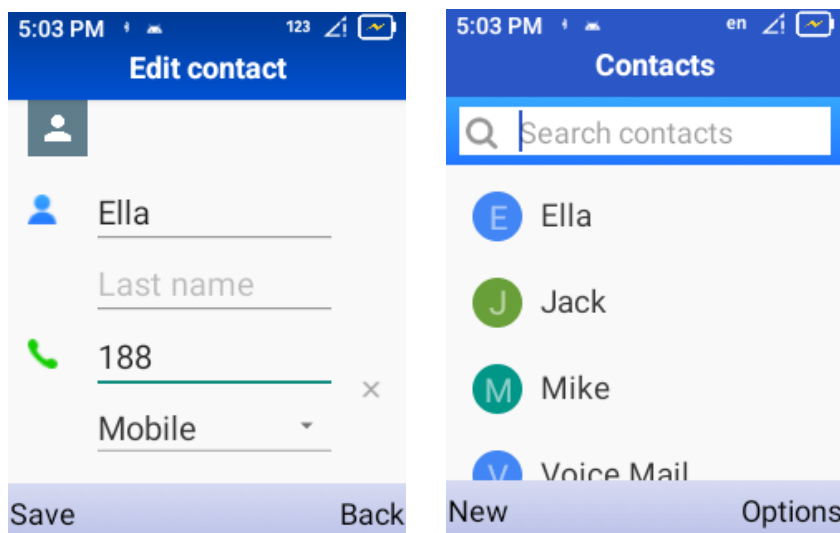

On the contacts list screen, use the **Navigation Key** to select a Contact, then press the **Center Soft Key** to access the detail screen.

- Press the **Right Soft Key** to send an SMS/MMS to the contact you selected.
- Press the **Right Soft Key** or **Center Soft Key** to make a call.



- Press the **Right Soft Key** to access Options: Send a message, Edit, Delete, Share.

3.3 Edit a Contact

On the contacts list screen, using the **Navigation Key** to select a Contact, then press the **Right Soft Key**  to access Options, select Edit contact and press the **Center Soft Key**  to edit.

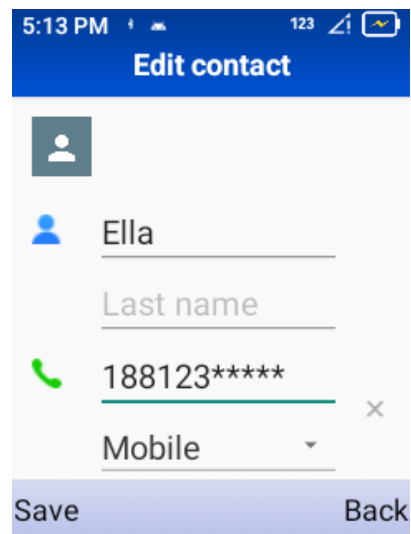
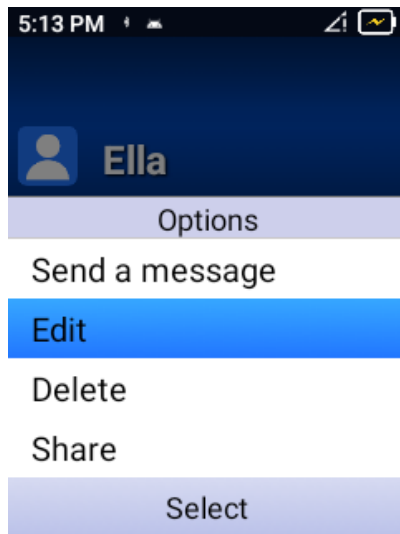

When finished, press the **Left Soft Key**  to save.

3.4 Share a Contact

You can share a single contact with others by sending the contact's vCard to them via Email, Messages, or Bluetooth.

On the contacts list screen, use the **Navigation Key** to select a Contact, then press the **Right Soft Key**  to access Options, and then select Share.

3.5 Delete Contacts

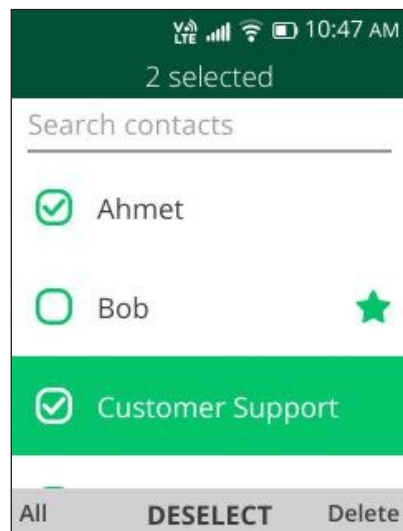
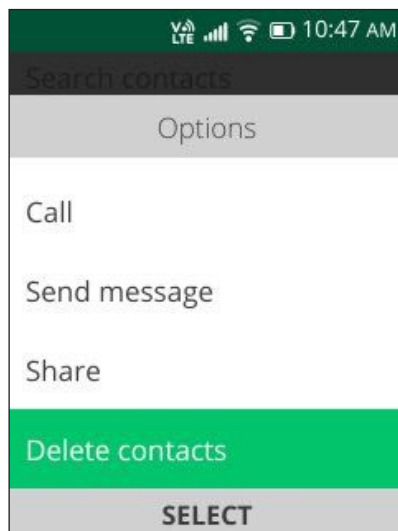

On the contacts list screen, press the **Right Soft Key**  to access Options, select Delete contacts, use the **Navigation Key** to view available contacts and the **Center Soft Key**  to make your selection, and then press the **Right Soft Key**  to delete.

3.6 Import/Export Contacts



On the contacts list screen, press the **Right Soft Key**  to access Options, select Settings > Import contacts/Export contacts to import/export contacts from/to memory

card, Gmail, Outlook, or Bluetooth.





4 Messages

Use the **Messaging** feature to send and receive text (SMS) and multimedia (MMS) messages.

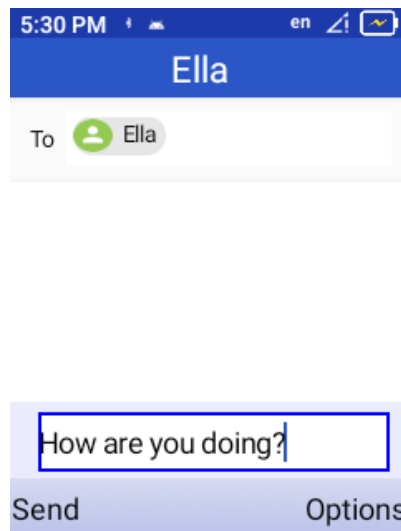
4.1 Sending a Text Message

Press the **Messages Key** , or from the home screen, press the **Center Soft Key**  and select **Messaging**  to enter Messages.



- Press the **Left Soft Key**  to write a new message.
- Enter the phone number of the recipient in the bar or press the **Left Soft Key**  to add recipients.
- Use the **Navigation Key** to go to the SMS bar to enter the text of the message.
- Press  Key to switch between the different methods.
- Press  Key to select symbols.
- Press the **Left Soft Key**  to send text messages.

Need to get something done? Just press a button and ask!

4.2 Sending a Multimedia Message

Press the **Right Soft Key**  to access Options.

MMS enables you to add contact, and subject status, send videos, pictures, photos, contacts and sounds to other compatible phones, insert contact, quick test and setting

An SMS will be converted to MMS automatically when media files (image, video, audio, etc.) are attached or email addresses are added.

An SMS of more than 160 characters will be charged as several SMS. Specific letters (accent) will also increase the size of the SMS. This may cause multiple SMS to be sent to your recipient.

5 Camera

Your mobile phone features a Camera and a Video to take photos and shoot videos.

5.1 Access the Camera

To access this function, press the **Center Soft Key**  from the home screen and select Camera.

5.2 Take a picture

Position the object or landscape in the screen and press the **Center Soft Key**  to take the photo. Photos will be automatically saved to the Multimedia-Picture.

After taking photo, press the **Left Soft Key**  to preview.

5.3 Zoom in/out

Press Up or Down of the **Navigation Key** to zoom lens in and out.

Press the **Right Soft Key**  to access options, press Left or Right of the **Navigation Key** to switch:

- Camera Resolution: Select the resolution as 2M, 1M.
- Self-Timer: Sets the time a photo is taken after pressing the **Center Soft Key**

5.4 Access the Video

- Press Left and Right of the **Navigation Key** to switch between Photo and Video mode.
- Press Up or Down of the **Navigation Key** to zoom in and out.
- Press the **Center Soft Key**  to record a video, press again to stop recording, videos will be automatically saved to Multimedia- Video app

6 Browser

To access this function, press the **Center Soft Key**  from the home screen and select browser

7 Multimedia

The Multimedia Group provides you with Pictures, Music, Video, FM Radio, Sound recorder.

To access this Group, press the **Center Soft Key**  from the home screen and select Multimedia.

Press the **Navigation Key** to switch each apps you want.

7.1 Picture

The Picture app provides you with one location to view and organize all your saved

photos.

To access this function, press the **Center Soft Key**  from the home screen and select Multimedia >Picture.

Press the **Navigation Key** to select picture list.

Use the **Navigation Key** to select an image and press the **Center Soft Key** to confirm, then press the **Right Soft Key** to access options below:

- Delete: Delete the selected photo.
- Edit: Select this option to rotate the photo, crop.
- Share: Share the photo via, Messages and Bluetooth, etc.
- Select Multiple: Allows you to select more than one photo in the Gallery.
- Details: Displays file path, size, resolution.
- Set as: Set the photo as Wallpaper or Image for existing contact.



7.2 Music

To access this function, press the **Center Soft Key**  from the home screen and select **Multimedia >Music**. Using this menu, you can play music files stored on phone storage in your phone. Music files can be downloaded from your computer to phone using a USB cable.

7.3 Video

Video acts as a media player for you to view videos.

To access this function, press the **Center Soft Key**  from the home screen and select Multimedia >Video

- Use the **Navigation Key** to select a video, press the **Center Soft Key**  to play the video.
- Press the **Right Soft Key**  to access Options.

7.4 FM Radio





Your phone is equipped with a radio. You can use the application as a traditional radio with saved channels or with parallel visual information related to the radio program on the display if you tune to stations that offer Visual Radio service.

To access this function, press the **Center Soft Key**  from the home screen and select Multimedia > FM Radio.

To use it, you must plug in your headset, which works as an antenna connected with your phone.

7.5 Sound Recorder.

To access this function, press the **Center Soft Key**  from the home screen and select **Multimedia > Sound Recorder**.

- Press the **Center Soft Key**  to start recording, press the **Center Soft Key**  to End.
- Press the **Right Soft Key** and use the **Navigation Key** to select the recorder, press the **Center Soft Key**  to play.
- Press the **Right Soft Key**  to access Options, such as share, delete, select multiple, rename, save as ringtone.

8 Tools

8.1 Calendar

Use the Calendar to keep track of important meetings, appointments, etc.

To access this function, press the **Center Soft Key**  from the home screen and select Tools > Calendar

You can display the Calendar in Day, Week, Month view. Press the **Right Soft Key**  to change your Calendar view.

a) Create New Event

Press the **Left Soft Key**  to add new events from any Calendar view.

- Fill in all required information for this new event. If it is a whole-day event, you can press the **Center Soft Key**  to select All-day.
- When finished, press the Left Soft Key  to save.
- Delete and Edit Event

After new event is created, under Month view or Day view, use the **Navigation Key** to move to the event. Press the **Center Soft Key**  to show events list, then press the **Right Soft Key**  to delete or press the **Left Soft Key**  to edit.

More options are available by pressing the **Right Soft Key**  from the Calendar main screen:

- Today: Quickly go to current day to operate.
- Settings: To set a series of Calendar settings.

b) Event reminder

If a reminder is set for an event, the upcoming event will appear on the Status bar as a notification when the reminder time arrives.

8.2 Calculator

To access this function, press the **Center Soft Key**  from the home screen and select

Tools > Calculator

- 0-9 key: Input numbers
- key: .
- Navi key: +, -, x, ÷
- : =
- : Clear
- : Options

8.3 Clock

To access this function, press the **Center Soft Key** from the home screen and select Tools > Clock

Press **Navigation Key** (Left, Right) to switch between Alarm, Timer, Stopwatch, Clock.

a) Set Alarm

Press the **Right Soft Key** to add a new alarm. Select Hour, Minutes, AM/PM, then Press OK.

More setting please press **Left Soft Key** to Edit. The following options will appear:

- Turn alarm on: Turn on/off alarm.
- Time: Select to set the alarm time.
- Repeat: Select the days you want your alarm to go off.
- Alarm Sound: Select a ringtone for the alarm.
- Delete alarm: Select to delete alarm or not.

Press the Back Key to Save.

b) Set Timer



Press the **Navigation Key** (up, down) to select and edit hour, minute and second, when finished, press the Center Soft Key to start the Timer.

- When the Timer is ongoing, press the **Center Soft Key** to pause and continue the Timer.
- When the Timer is paused, press the **Left Soft Key** to reset the Timer.

c) To Set the Stopwatch

- Press the **Center Soft Key** to start Stopwatch.
- When the Stopwatch is ongoing, press the **Right Soft Key** to record the lap, press the **Center Soft Key** to pause the time.
- When the Stopwatch is paused, press the **Center Soft Key** to continue the total time, press the **Left Soft Key** to reset the stopwatch and clear lap times.



d) Clock

- press the **Left Soft Key**  to ALL to select world time of each time zone. Press **Back Key**  to check all selected times.

9 Applications

9.1 E-Mail







a) Setup E-Mail

You can access this function by pressing the **Center Soft Key**  from the home screen, select Applications and select E-Mail. 

An email Account setup will guide you through the steps to set up an email account, select next to continue.

- Enter the name and email for the account you want to setup.
- Press the **Navigation Key** and select NEXT to next step. If the account you entered is not provided by your service provider in the phone, you will be prompted to manually setup your email.
- To add another email account, you can press the **Right Soft Key**  to access Options > Settings, then select Add.

b) Send E-Mail

- Press the **Left Soft Key**  to compose a new email from the Inbox screen.
- Enter recipient(s) email address(es) in the To field, press the **Center Soft Key**  to confirm and add new recipient(s).
- Type the subject and the content of the message. You may use your voice to enter the subject and content of your emails by pressing and holding the **Center Soft Key**  button.
- If necessary, press the **Right Soft Key**  to Add cc/bcc or Add attachment to the message.
- If you do not want to send the mail right away, you can press the **Right Soft Key**  and select Save as draft to save a copy.
- Finally, press the **Left Soft Key**  to send.

9.2 File Manager

From the Home screen, pressing the **Center Soft Key** , select Applications and select File Manager.

File Manager displays all data stored on the phone and the microSD card, including applications, media files downloaded from Store, YouTube or other locations; videos, pictures or audios you have captured; other data transferred via Bluetooth, USB cable, etc.





When you download an application from PC to phone/microSD card, you can locate the application using File Manager, then touch it to install it in your phone.

File Manager allows you to perform and be really efficient with the following common operations: create (sub) folder, open folder/file, view, rename, move, copy, delete, play,

share, etc.

9.3 Note

Press the **Center Soft Key**  from the home screen, select Applications and select Note

- Press the **Left Soft Key**  to add new note, enter contents then press the **Left Soft Key**  to Save.
- On the notes list, press the **Right Soft Key**  to access Options, such as delete, share, select Notes.
- Use the **Navigation Key** to select the note, press the **Center Soft Key**  to view detail, edit. Press the **Right Soft Key**  to delete or share the note via Email, Messages, or Bluetooth.

10 Setting

From the Home screen, press the **Center Soft Key**  and select Settings . Then you will see below all options.





10.1 Wireless & Network

Select wireless & Network and press **Center Soft Key**  to access.

a) Wi-Fi

Wi-Fi will allow you to surf the internet without using your mobile network when in range of a wireless network.



Press the **Center Soft Key**  to enter Wi-Fi.

- Press the Up and Down of the **Navigation Key** to select On, then press the **Center Soft Key**  to turn on Wi-Fi.
- Press the Up and Down of the **Navigation Key** to select Available networks, then press the **Center Soft Key**  to enter all available networks list, select one and press the **Center Soft Key**  to configure the access point and connect your phone. Be advised you may need to enter a password if applicable.
- Press the Up and Down of the **Navigation Key** to select Wi-Fi preferences and Saved networks, then press the **Center Soft Key**  to set more options.

b) Bluetooth

Bluetooth allows your phone to exchange data (videos, images, music, etc.) with other Bluetooth devices within a close range such as another phone, computer, printer, headset, etc.

Press the **Center Soft Key**  to enter Bluetooth.

- Press the Up and Down of the **Navigation Key** to select On, then press the **Center Soft Key**  to turn on Bluetooth.
- Use Bluetooth: Press the **Center Soft Key**  to turn on/off.
- Device Name: Press the **Center Soft Key**  to enter, edit the name then press the **Navigation Key** to select RENAME to save.

- Pair Devices: Press the **Center Soft Key** to enter nearby devices list, using the Up and Down of the **NavigationKey** to select a needed device, press the **Center Soft Key** to confirm.

c) Mobile Network

Press the **Center Soft Key** to enter Mobile network.

- Mobile data: Access data using mobile network. Press **Center Soft Key** to turn on/off
- Roaming: Connect to data services when roaming. Press **Center Soft Key** to turn on/off.
- APP data usage: Access and see each APP data usage value.
- Data warning & limit: Access and set the data warning on/off, data limit on/off, data limit value.
- Preferred network type: Access and set LTE type.
- Wi-Fi calling: To disable and enable Wi-Fi calling.

d) Airplane Mode

When Airplane mode is on, all wireless connections are disabled simultaneously, including Wi-Fi and Bluetooth.

- Press the **Center Soft Key** to turn on/off.

e) Tethering and Mobile Hotspot

- Mobile Hotspot: Turn your phone into a portable Wi-Fi Hotspot so you can share your mobile data connection with other devices.

Press the **Center Soft Key** to turn on/off.

Note: First time to set, you need to set the spot name and password, then save. Not necessary after first setting.

- USB tethering: Connect your phone to a computer using the USB cable and turn on the USB tethering to share the data connection.

Note: Only once USB connected, this feature can be activated,

- Mobile Hotspot Setting: Setting Hotspot name, password, Maximum connections, preferred channel.
- Mobile Hotspot turn off timer: Access and select by pressing **Center Soft Key** and set idle time to turn off hotspot.

f) Data Saver

Data Saver feature can be turned on or off by the user. If it is on, the app developers can handle the situation gracefully by tuning their applications for low- or no-data access.

g) USB

There have several modes for end-user to select Charging only, File transfer, USB tethering, MIDI, PTP, No data transfer.

h) 10.1.8 VPN

Press the **Left Soft Key**  to add new VPN.

Enter the required VPN information, when finished, Select Save.

i) Files received via Bluetooth

This showed the details of transferring history through Bluetooth.

10.2 APPS

Including all apps here from system and personal download.

Press **Navigation Key** to select and **Center Soft Key**  to access. Open & Disable & Force stop will be options to select.

Notifications: Turn on/off to show this on home screen or not.

10.3 Sounds

a) To adjust Volume:

- Call Volume: Press the Volume Up/Down button that is located on the right side of the device to adjust the Ringtone & Alerts volume. Or **Navigation Key** (Left and right)
- Ring & notification & alarm: Press the **Navigation Key** (Left and right)

b) To adjust ringtones

- Press the **Center Soft Key**  to access.
- Press the **Navigation Key** (up and down)
- Press OK to save.

c) Sound > Tones.

- Under Tones, you may select your preference on Vibrate, Ringtones, Notification Alerts as well as Manage Tones.
- Press the **Center Soft Key**  to confirm.

d) To adjust Other Sounds

All other sounds that are related to Dial Pad or Camera can be adjusted by doing the following:













- From the Home screen, press the **Center Soft Key** , select Settings > Sound > Other Sounds.

10.4 Display

a) To adjust Brightness



- From the Home screen, press the **Center Soft Key** , select Settings > Display.
- Press the **Navigation Key** to highlight Brightness.
- Select desired brightness by pressing the Left or Right of the **Navigation Key**.

b) To adjust Wallpaper

- From the Home screen, press the **Center Soft Key** , select Settings  > Display > Wallpaper.
 - Press Picture to select from Images that are stored on your device.
 - Press Camera to take a picture for the Wallpaper you would like to use/store.
 - Press Wallpapers to select from pre-loaded Wallpapers.
- c) To adjust Screen timeout
- From the Home screen, press the **Center Soft Key** , select Settings  > Display > Screen timeout.
 - Select when you would like your screen to turn off, then press the **Center Soft Key**  to confirm.
- d) To adjust Key backlight timeout
- From the Home screen, press the **Center Soft Key** , select Settings  > Display > Key backlight timeout.
 - Select when you would like your screen to turn off, then press the **Center Soft Key**  to confirm.
- e) Change font size
- From the Home screen, press the **Center Soft Key** , select Settings  > Display > Font size
 - Go down to the bottom page ,Press **Navigation Key** (Left and right) select small, default, large, largest. Then Press back to save.
- f) Change Display size
- From the Home screen, press the **Center Soft Key** , select Settings  > Display > Display size
 - Go down to the bottom page ,Press **Navigation Key** (Left and right) select small, default. Then Press back to save.



10.5 Battery

From the Home screen, press the **Center Soft Key** , select Settings  > Battery
At the top of page, battery capacity percentage will be seen.

- Battery usage: To see an overview of your battery level and activity for the last 24 hours and up to the 0% battery capacity.
- Use battery Manager: Press **Center Soft Key**  to turn on/off detection when apps drain battery
- Battery percentage: Press **Center Soft Key**  to show battery percentage in status bar.





10.6 Storage

From the Home screen, press the **Center Soft Key** , select Settings  > Storage.

- This Device: press the **Center Soft Key**  to access and select SD card or This device
- Free up space: press the **Center Soft Key**  to access and free up the space.

10.7 Accessibility



From the Home screen, press the **Center Soft Key** , select Settings  > Accessibility

- Vibration: press the **Center Soft Key**  to turn on/off Ring vibration and Notification vibration
- TTY Mode: press the **Center Soft Key**  to select TTY off, TTY full, TTY HCO, TTY VCO.
- RTT mode: press the **Center Soft Key**  to turn on/off RTT call
- Audio adjustment: press the **Center Soft Key**  to turn on/off Mono audio. Press **Navigation Key** (Left and right) to modify audio balance.

10.8 Privacy & Security

a) Lock/Unlock your screen

To protect your phone and privacy, you can lock the phone screen by creating a password.

- From the Home screen, press the **Center Soft Key** , select Settings  > Privacy & security > Screen lock. Select Pin to set lock password. Select None to cancel PIN locking.

b) Device admin apps

Activating this admin app will allow the app file manager to perform the following operations:

- Change the screen lock
- Set password rules
- Lock the screen

c) SIM Security

A SIM PIN prevents access to the SIM card cellular data networks. When it's enabled, any device containing the SIM card will request the PIN upon restart. A SIM PIN is not the same as the lock code used to unlock the device.

10.9 Software Update



To access Software Updates, follow the steps below:

- Connect your device to a Wi-Fi network and make sure it has a strong data connection.
- Ensure your battery is fully charged before starting the software update. Your device's current battery level can be found on your device under Settings > Software Update > Check for updates
- When there is a new mandatory software update version available, the phone will start downloading automatically, then select Continue to update your system.

10.10 System

a) Language & input

Your device can be operated using English, Spanish, etc. language.

- From the Home screen, press the **Center Soft Key** , select Settings  > System > language
- Press the **Navigation Key** to select the desired languages preference.
- Press the **Center Soft Key**  to confirm.

b) Date & Time

From the Home screen, press the **Center Soft Key** , select Settings  > System > Date & Time

a) Set time automatically:

- Use network-provided time- Time will be set according to your SIM network information.
- Use GPS-provided time- Time will be set according to your location information
- Off- Turn off time setting automatically. Only off, you can set date and time manually next step.

b) Automatic time zone: Press **Center Soft Key** to turn on/off

c) Select time zone: Press **Center Soft Key** to select the zone according to location.

Note: Only Automatic time zone is off, time zone can be selected manually.

d) Use Locate default & Use 24-hour format: Press **Center Soft Key** to turn on/off the default or personal selection.

11 Safety and Precautions

11.1 Device Precautions

- a) This mobile phone is well designed with fine art. Please exercise special care when using it. The following suggestions will help your mobile phone survive the warranty period and extend its service life:
- b) Keep the mobile phone and all its fittings beyond children's reach.
- c) Keep the mobile phone dry. Keep away from rain, moisture, liquid or other substances that may corrode electronic circuits.
- d) Do not use or store the mobile phone in dusty place, lest those active parts of the mobile phone be damaged.
- e) Do not store the mobile phone in a high-temperature place. High temperature will shorten the life of electronic circuits and damage the battery and some plastic parts.
- f) Do not store the mobile phone in a chilly place. Otherwise, moistures will be formed inside the mobile phone to damage electronic circuits when the mobile phone is moved to a constant temperature place.
- g) Do not throw, knock or shock the mobile phone, as that will destroy the internal circuits and high-precision components of the mobile phone.
- h) Do not puncture, disassemble or cause a short-circuit in a battery.

- i) Do not burn or dispose of a used battery in household rubbish or store it at temperatures above 60°C
- j) The operating temperature for the phone is 14°F (-10°C) to 131°F (55°C). The charging temperature for the phone is 32°F (0°C) to 104°F (40°C)

11.2 Battery Precautions

- a) Do not disassemble or open crush, bend or deform, puncture or shred
- b) Do not modify or remanufacture, attempt to insert foreign objects into the battery, immerse or expose to water or other liquids, expose to fire, explosion or another hazard.
- c) Only use the battery with a charging system that has been qualified with the system per CTIA Certification Requirements for Battery System Compliance to IEEE 1725. Use of an unqualified battery or charger may present a risk of fire, explosion, leakage, or another hazard.
- d) Replace the battery only with another battery that has been qualified with the system per this standard, IEEE-Std-1725. Use of an unqualified battery may present a risk of fire, explosion, leakage or another hazard.
- e) Promptly dispose of used batteries in accordance with local regulations
- f) Avoid dropping the phone or battery. If the phone or battery is dropped, especially on a hard surface, and the user suspects damage, take it to a service center for inspection.
- g) Improper battery use may result in a fire, explosion or other hazard.

11.3 FCC Notice and Cautions

This device and its accessories comply with Part 15 of FCC Rules. Operation is subject to the following conditions:

- a) This device and its accessories may not cause harmful interference.
- b) This device and its accessories must accept any interference received, including interference that may cause undesired operation.

Part 15.21 Statement:

Changes or modifications that are not expressly approved by the manufacturer could void the user's authority to operate the equipment.

Part of Statement 15.105:

This equipment has been tested and found to comply with the limits for a class B digital device, pursuant to Part 15 of the FCC Rules. These limits are designed to provide reasonable protection against harmful interference in a residential installation. This equipment generates, uses, and can radiate radio frequency energy and, if not installed and used in accordance with the instructions, may cause harmful interference to radio communications.

However, there is no guarantee that interference will not occur in a particular installation. If you experience interference with reception (e.g., television), determine if this equipment is

causing the harmful interference by turning the equipment off and then back on to see if the interference is affected.

If necessary, try correcting the interference by one or more of the following measures:

-Reorient or relocate the receiving antenna.

- Increase the separation between the equipment and receiver.
- Connect the equipment into an outlet on a circuit different from that to which the receiver is connected.
- Consult the dealer or an experienced radio/TV technician for further assistance.

11.4 Consumer Information on SAR

This Model Phone Meets the Government's Requirements for Exposure to Radio Waves. Your wireless phone is a radio transmitter and receiver. It is designed and manufactured not to exceed the emission limits for exposure to radiofrequency (RF) energy set by the Federal Communications Commission (FCC) of the U.S. Government. These FCC exposure limits are derived from the recommendations of two expert organizations, the National Council on Radiation Protection and Measurement (NCRP) and the Institute of Electrical and Electronics Engineers (IEEE). In both cases, the recommendations were developed by scientific and engineering experts drawn from industry, government, and academia after extensive reviews of the scientific literature related to the biological effects of RF energy. The exposure limit for wireless mobile phones employs a unit of measurement known as the Specific Absorption Rate, or SAR. The SAR is a measure of the rate of absorption of RF energy by the human body expressed in units of watts per kilogram (W/kg). The FCC requires wireless phones to comply with a safety limit of 1.6 watts per kilogram (1.6 W/kg). The FCC exposure limit incorporates a substantial margin of safety to give additional protection to the public and to account for any variations in measurements. Tests for SAR are conducted using standard operating positions specified by the FCC with the phone transmitting at its highest certified power level in all tested frequency bands. Although SAR is determined at the highest certified power level, the actual SAR level of the phone while operating can be well below the maximum value. Because the phone is designed to operate at multiple power levels to use only the power required to reach the network, generally, the closer you are to a wireless base station antenna, the lower the power output. Before a phone model is available for sale to the public, it must be tested and certified to the FCC that it does not exceed the limit established by the government adopted requirement for safe exposure. The tests are performed in positions and locations (e.g., at the ear and worn on the body) as required by the FCC for each model. This device was tested for typical body-worn operations with the back of the phone kept 0.39 inches (1.0 cm) between the user's body and the back of the phone. To comply with FCC RF exposure requirements, a minimum separation distance of 0.39 inches (1.0 cm) must be maintained between the user's body and the back of the phone. Third-party belt clips, holsters, and similar accessories containing metallic components should not be used.

Body-worn accessories that cannot maintain 0.39 inches (1.0 cm) separation distance between the user's body and the back of the phone, and have not been tested for typical body-worn operations may not comply with FCC RF exposure limits and should be avoided.

The FCC has granted an Equipment Authorization for this model phone with all reported SAR levels evaluated as in compliance with the FCC RF emission guidelines.

The highest SAR value for this model phone when tested for use at the head is **1.084 W/kg** and when worn on the body, as described in this user's manual, is **1.189 W/kg**. While there may be differences between SAR levels of various phones and at various positions, they all meet the government requirement for safe exposure. SAR information on this model phone is on file with the FCC and can be found under the Display Grant section of <http://www.fcc.gov/oet/ea/fccid/> after searching on FCC ID: 2A33N-L62A. To find information that pertains to a particular model phone, this site uses the phone FCC ID number which is usually printed somewhere on the case of the phone. Sometimes it may be necessary to remove the battery pack to find the number. Once you have the FCC ID number for your phone, follow the instructions on the website and it should provide values for typical or maximum SAR for that phone.

Additional information on Specific Absorption Rates (SAR) can be found on the Cellular Telecommunications Industry Association (CTIA) website at <http://www.ctia.org/>

In the United States and Canada, the SAR limit for mobile phones used by the public is 1.6 watts/kg (W/kg) averaged over one gram of tissue. The standard incorporates a substantial margin of safety to give additional protection for the public and to account for any variations in measurements.

11.5 FCC Hearing-Aid Compatibility (HAC) Regulations for Wireless Devices

This device has been tested and rated for use with hearing aids, with some of the wireless technologies that it uses. However, there may be newer wireless technologies used in the device that have not been tested yet for use with hearing aids. It is important to try the different features on your device thoroughly and in different locations whilst using a hearing aid or cochlear implant to determine if there is any interfering noise.

The FCC has adopted HAC rules for digital wireless phones. These rules require certain devices to be

tested and rated under the American National Standard Institute (ANSI) C63.19-2011 hearing aid compatibility standards. The ANSI standard for hearing aid compatibility contains two types of ratings:

- M-Ratings: Phones rated M3 or M4 meet FCC requirements and are likely to generate less interference to hearing devices than mobile devices that are not labelled. M4 is the better/higher of the two ratings.
- T-Ratings: Phones rated T3 or T4 meet FCC requirements and are likely to work better with a hearing device's telecoil ("T Switch" or "Telephone Switch") than unrated phones. T4 is the better/higher of the two ratings. (Note not all hearing devices have telecoils in them.)
- The tested M-Rating and T-Rating for this device are **M4** and **T4**.

11.6 Copyright Information

©2022 Hot Pepper Mobile Inc. All rights reserved. Other marks are the property of their respective owners. The Mobile name, signature and the logo are registered trademarks of Hot Pepper Mobile Inc.