



# SAR TEST REPORT

For

Hot Pepper Mobile Inc.

DT20

Test Model:HPPAP21

Additional Model No.: /

Prepared for : Hot Pepper Mobile Inc.  
Address : 350 10th Ave 1000 Ste San Diego California United States  
92101-8705

Prepared by : Shenzhen LCS Compliance Testing Laboratory Ltd.  
Address : 101, 201 Bldg A & 301 Bldg C, Juji Industrial Park  
Yabianxueziwei, Shajing Street, Baoan District, Shenzhen,  
518000, China  
Tel : (86)755-82591330  
Fax : (86)755-82591332  
Web : www.LCS-cert.com  
Mail : webmaster@LCS-cert.com

Date of receipt of test sample : July 14, 2023  
Number of tested samples : 1  
Sample number : A060723142-1  
Serial number : Prototype  
Date of Test : July 14, 2023~July 24, 2023  
Date of Report : August 09, 2023





### SAR TEST REPORT

**Report Reference No. .... : LCSA060723144EB**

**Date Of Issue ..... : August 09, 2023**

**Testing Laboratory Name ..... : Shenzhen LCS Compliance Testing Laboratory Ltd.**

**Address ..... : 101, 201 Bldg A & 301 Bldg C, Juji Industrial Park  
Yabianxueziwei, Shajing Street, Baoan District, Shenzhen,  
518000, China**

**Testing Location/ Procedure ..... : Full application of Harmonised standards   
Partial application of Harmonised standards   
Other standard testing method**

**Applicant's Name ..... : Hot Pepper Mobile Inc.**

**Address ..... : 350 10th Ave 1000 Ste San Diego California United States 92101-8705**

**Test Specification:**

**Standard ..... : IEEE Std C95.1, 2019/IEC-IEEE 62209-1528-2020  
/FCC Part 2.1093**

**Test Report Form No. .... : LCSEMC-1.0**

**TRF Originator ..... : Shenzhen LCS Compliance Testing Laboratory Ltd.**

**Master TRF ..... : Dated 2011-03**

**Shenzhen LCS Compliance Testing Laboratory Ltd. All rights reserved.**

This publication may be reproduced in whole or in part for non-commercial purposes as long as the Shenzhen LCS Compliance Testing Laboratory Ltd. is acknowledged as copyright owner and source of the material. Shenzhen LCS Compliance Testing Laboratory Ltd. takes no responsibility for and will not assume liability for damages resulting from the reader's interpretation of the reproduced material due to its placement and context.

**Test Item Description. .... : DT20**

**Trade Mark ..... : Hot Pepper**

**Test Model ..... : HPPAP21**

**Operation Frequency ..... : WLAN2.4G, WLAN5.2G,WLAN5.8G  
Bluetooth5.0**

**For AC Adapter Model: FX2U-050200U  
Input: 100-240V~, 50/60Hz, 0.4A Max**

**Ratings ..... : Output: 5V 2A  
DC 3.8V by Rechargeable Li-ion Battery, 6580mAh  
(Battery Model: 3091145P)**

**Result ..... : Positive**

**Compiled by:**

*Jay zhan*

Jay Zhan / File administrators

**Supervised by:**

*Cary Luo*

Cary Luo / Technique principal

**Approved by:**

*Gavin Liang*

Gavin Liang / Manager





# SAR -- TEST REPORT

|   |   |
|---|---|
| <b>Test Report No. :</b> <b>LCSA060723144EB</b> | <u>August 09, 2023</u><br>Date of issue |
|---|---|

|                          |   |
|--------------------------|---|
| Type / Model.....        | : HPPAP21   |
| EUT.....                 | : DT20  |
| <b>Applicant.....</b>    | <b>: Hot Pepper Mobile Inc.</b>   |
| Address.....             | : 350 10th Ave 1000 Ste San Diego California United States<br>92101-8705  |
| Telephone.....           | : /   |
| Fax.....                 | : /   |
| <b>Manufacturer.....</b> | <b>: Hot Pepper Mobile Inc.</b>   |
| Address.....             | : 350 10th Ave 1000 Ste San Diego California United States<br>92101-8705  |
| Telephone.....           | : /   |
| Fax.....                 | : /   |
| <b>Factory.....</b>      | <b>: Shenzhen Mediafly Technology CO.,LTD</b>   |
| Address.....             | : 6/F, Building A, WeiXing Science And Technology Park,<br>No. 268-3, BaoShi East Rd, ShuiTian Community, ShiYan<br>Street, BaoAn District, ShenZhen, China |
| Telephone.....           | : /   |
| Fax.....                 | : /   |

|                    |                 |
|--------------------|-----------------|
| <b>Test Result</b> | <b>Positive</b> |
|--------------------|-----------------|

The test report merely corresponds to the test sample.

It is not permitted to copy extracts of these test result without the written permission of the test laboratory.





### Revision History

| Revision | Issue Date      | Revision Content | Revised By |
|----------|-----------------|------------------|------------|
| 000      | August 09, 2023 | Initial Issue    | ---        |
|          |                 |                  |            |
|          |                 |                  |            |





# TABLE OF CONTENTS

- 1. TEST STANDARDS AND TEST DESCRIPTION.....6**
  - 1.1. TEST STANDARDS .....6
  - 1.2. TEST DESCRIPTION .....6
  - 1.3. GENERAL REMARKS .....6
  - 1.4. PRODUCT DESCRIPTION .....6
  - 1.5. STATEMENT OF COMPLIANCE .....8
- 2. TEST ENVIRONMENT .....9**
  - 2.1. TEST FACILITY .....9
  - 2.2. ENVIRONMENTAL CONDITIONS .....9
  - 2.3. SAR LIMITS .....9
  - 2.4. EQUIPMENTS USED DURING THE TEST .....10
- 3. SAR MEASUREMENTS SYSTEM CONFIGURATION .....11**
  - 3.1. SAR MEASUREMENT SET-UP .....11
  - 3.2. OPENSAR E-FIELD PROBE SYSTEM .....12
  - 3.3. PHANTOMS .....13
  - 3.4. DEVICE HOLDER .....14
  - 3.5. SCANNING PROCEDURE .....14
  - 3.6. DATA STORAGE AND EVALUATION .....16
  - 3.7. POSITION OF THE WIRELESS DEVICE IN RELATION TO THE PHANTOM .....17
  - 3.8. TISSUE DIELECTRIC PARAMETERS FOR HEAD AND BODY PHANTOMS .....19
  - 3.9. TISSUE EQUIVALENT LIQUID PROPERTIES .....19
  - 3.10. SYSTEM CHECK .....20
  - 3.11. SAR MEASUREMENT PROCEDURE .....22
  - 3.12. POWER REDUCTION .....25
  - 3.13. POWER DRIFT .....25
- 4. TEST CONDITIONS AND RESULTS .....26**
  - 4.1. CONDUCTED POWER RESULTS .....26
  - 4.2. TRANSMIT ANTENNAS AND SAR MEASUREMENT POSITION .....28
  - 4.3. SAR MEASUREMENT RESULTS .....31
  - 4.4. SAR MEASUREMENT VARIABILITY .....33
  - 4.5. GENERAL DESCRIPTION OF TEST PROCEDURES .....34
  - 4.6. MEASUREMENT UNCERTAINTY (450MHZ-6GHZ) .....34
  - 4.7. SYSTEM CHECK RESULTS .....35
  - 4.8. SAR TEST GRAPH RESULTS .....38
- 5. CALIBRATION CERTIFICATES .....41**
  - 5.1. PROBE-EPGO376 CALIBRATION CERTIFICATE .....41
  - 5.2. SID2450 DIPOLE CALIBRATION CERITICATE .....52
  - 5.3. SID5-6G DIPOLE CALIBRATION CERITICATE .....64
- 6. EUT TEST PHOTOGRAPHS .....77**
  - 6.1. PHOTOGRAPH OF LIQUID DEPTH .....77
- 7. PHOTOGRAPHS OF THE TEST .....79**
- 8.EUT PHOTOGRAPHS .....80**







# 1. TEST STANDARDS AND TEST DESCRIPTION

## 1.1. Test Standards

[IEEE Std C95.1, 2019](#): IEEE Standard for Safety Levels with Respect to Human Exposure to Electric, Magnetic, and Electromagnetic Fields, 0 Hz to 300 GHz. It specifies the maximum exposure limit of 1.6 W/kg as averaged over any 1 gram of tissue for portable devices being used within 20 cm of the user in the uncontrolled environment.

[IEC-IEEE 62209-1528-2020: Measurement procedure for the assessment of specific absorption rate of human exposure to radio frequency fields from hand-held and body-mounted wireless communication devices –Part 1528: Human models, instrumentation, and procedures\(Frequency range of 4 MHz to 10 GHz\)](#)

[KDB447498 D01 General RF Exposure Guidance](#) : Mobile and Portable Device RF Exposure Procedures and Equipment Authorization Policies

[KDB865664 D01 SAR Measurement 100 MHz to 6 GHz](#) : SAR Measurement Requirements for 100 MHz to 6 GHz

[KDB865664 D02 RF Exposure Reporting](#): RF Exposure Compliance Reporting and Documentation Considerations

[KDB 616217 D04 SAR for laptop and tablets v01r02](#): SAR Evaluation procedures for umpc mini-tablet devices

[KDB248227 D01 802.11 Wi-Fi SAR](#): SAR GUIDANCE FOR IEEE 802.11 (Wi-Fi) TRANSMITTERS

## 1.2. Test Description

The EUT battery must be fully charged and checked periodically during the test to ascertain uniform power . And Test device is identical prototype.

## 1.3. General Remarks

|                                |   |               |
|--------------------------------|---|---------------|
| Date of receipt of test sample | : | July 14, 2023 |
| Testing commenced on           | : | July 14, 2023 |
| Testing concluded on           | : | July 24, 2023 |

## 1.4. Product Description

The **Hot Pepper Mobile Inc.**'s Model:DT20 or the "EUT" as referred to in this report; more general information as follows, for more details, refer to the user's manual of the EUT.

| General Description   |  |
|---|--|
| Product Name:   | DT20   |
| Model/Type reference:   | HPPAP21  |
| Additional Model No.:   | /  |
| Model Declaration:  | /  |
| Hardware Version:   | WT-P31-Y-6771-BED-UMCP-MB-V2.1-20230525  |
| Software Version:   | android_12.0.8_27062023  |
| Power supply:   | For AC Adapter Model: FX2U-050200U<br>Input: 100-240V~, 50/60Hz, 0.4A Max<br>Output: 5V 2A<br>DC 3.8V by Rechargeable Li-ion Battery, 6580mAh<br>(Battery Model: 3091145P) |
| <i>The EUT is DT20. It is equipped with Bluetooth, WiFi2.4G, WiFi5.2G, WiFi5.8G . For more information see the following datasheet,</i> |  |
| Technical Characteristics   |  |
| 2.4G WLAN   |  |
| Operation frequency:  | 2412MHz ~ 2462 MHz   |
| Channel separation:   | 5MHz   |
| Channel Number:   | 11 Channels for 20MHz bandwidth (2412~2462MHz)<br>7 Channels for 40MHz bandwidth (2422~2452MHz)  |
| Modulation Technology:  | IEEE 802.11b: DSSS (CCK, DQPSK, DBPSK)<br>IEEE 802.11g: OFDM (64QAM, 16QAM, QPSK, BPSK)<br>IEEE 802.11n: OFDM (64QAM, 16QAM, QPSK, BPSK)                                   |
| Antenna Description:  | PIFA Antenna, 0.22dBi(Max.)  |



Shenzhen LCS Compliance Testing Laboratory Ltd.

Add: 101, 201 Bldg A & 301 Bldg C, Juji Industrial Park Yabianxueziwei, Shajing Street, Baoan District, Shenzhen, 518000, China

Tel: +(86) 0755-82591330 | E-mail: webmaster@lcs-cert.com | Web: www.lcs-cert.com

Scan code to check authenticity



| 5.2G WLAN            |  |
|----------------------|--|
| Frequency Range      | 5180-5240MHz   |
| Channel Number       | 4 Channels for 20MHz bandwidth(5180MHz~5240MHz)<br>2 channels for 40MHz bandwidth(5190MHz~5230MHz)<br>1 channels for 80MHz bandwidth(5210MHz)            |
| Modulation Type      | IEEE 802.11a: OFDM (64QAM, 16QAM, QPSK, BPSK)<br>IEEE 802.11n: OFDM (64QAM, 16QAM, QPSK, BPSK)<br>IEEE 802.11ac: OFDM (256QAM, 64QAM, 16QAM, QPSK, BPSK) |
| Antenna Description: | PIFA Antenna,2.06dBi(Max.)   |
| 5.8G WLAN            |  |
| Frequency Range      | 5745MHz-5825MHz  |
| Channel Number       | 5 channels for 20MHz bandwidth(5745MHz~5825MHz)<br>2 channels for 40MHz bandwidth(5755MHz~5795MHz)<br>1 channels for 80MHz bandwidth(5775MHz)            |
| Modulation Type      | IEEE 802.11a: OFDM (64QAM, 16QAM, QPSK, BPSK)<br>IEEE 802.11n: OFDM (64QAM, 16QAM, QPSK, BPSK)<br>IEEE 802.11ac: OFDM (256QAM, 64QAM, 16QAM, QPSK, BPSK) |
| Antenna Description: | PIFA Antenna, -0.02dBi(Max.)   |
| Bluetooth            |  |
| Bluetooth Version:   | V5.0   |
| Modulation Type:     | GFSK, $\pi/4$ -DQPSK, 8-DPSK for Bluetooth V5.0(DSS)<br>GFSK for Bluetooth V5.0 (DTS)  |
| Operation frequency: | 2402MHz~2480MHz  |
| Channel number:      | 79 channels for Bluetooth V5.0(DSS)<br>40 channels for Bluetooth V5.0 (DTS)  |
| Channel separation:  | 1MHz for Bluetooth V5.0 (DSS)<br>2MHz for Bluetooth V5.0 (DTS)   |
| Antenna Description: | PIFA Antenna, 0.22dBi(Max.)  |
| GPS Receiver:        | Support and only RX  |
| FM:                  | Support and only RX  |





### 1.5. Statement of Compliance

The maximum of results of SAR found during testing for HPPAP21 are follows:

#### <Highest Reported standalone SAR Summary>

| Classment Class | Frequency Band | Body-worn<br>(Report SAR <sub>1-g</sub> (W/kg)<br>(Separation Distance<br>0mm) |
|-----------------|----------------|--|
|                 |                | DTS  |
| NII             | WIFI 5.2G      | 0.232  |
|                 | WIFI 5.8G      | 0.189  |

This device is in compliance with Specific Absorption Rate (SAR) for general population/uncontrolled exposure limits (1.6 W/kg) specified in FCC 47 CFR part 2 (2.1093) and ANSI/IEEE C95.1-2005, and had been tested in accordance with the measurement methods and procedures specified in IEC-IEEE 62209-1528-2020.







## 2. TEST ENVIRONMENT

### 2.1. Test Facility

The test facility is recognized, certified, or accredited by the following organizations:

Site Description  
SAR Lab.

- : NVLAP Accreditation Code is 600167-0.
- FCC Designation Number is CN5024.
- CAB identifier is CN0071.
- CNAS Registration Number is L4595.
- Test Firm Registration Number: 254912.

### 2.2. Environmental conditions

During the measurement the environmental conditions were within the listed ranges:

|                       |              |
|-----------------------|--------------|
| Temperature:          | 18-25 ° C    |
| Humidity:             | 40-65 %      |
| Atmospheric pressure: | 950-1050mbar |

### 2.3. SAR Limits

| EXPOSURE LIMITS  | FCC Limit (1g Tissue)                                    |  |
|--|--|--|
|  | SAR (W/kg)   |  |
|  | (General Population / Uncontrolled Exposure Environment) | (Occupational / Controlled Exposure Environment) |
| Spatial Average(averaged over the whole body)            | 0.08   | 0.4  |
| Spatial Peak(averaged over any 1 g of tissue)            | 1.6  | 8.0  |
| Spatial Peak(hands/wrists/feet/anklesaveraged over 10 g) | 4.0  | 20.0   |

Population/Uncontrolled Environments are defined as locations where there is the exposure of individual who have no knowledge or control of their exposure.

Occupational/Controlled Environments are defined as locations where there is exposure that may be incurred by people who are aware of the potential for exposure (i.e. as a result of employment or occupation).





## 2.4. Equipments Used during the Test

| Item | Equipment                           | Manufacturer | Model No. | Serial No.                | Cal Date   | Due Date   |
|------|-------------------------------------|--------------|-----------|---------------------------|------------|------------|
| 1    | PC                                  | Lenovo       | G5005     | MY42081102                | N/A        | N/A        |
| 2    | SAR Measurement system              | SATIMO       | 4014_01   | SAR_4014_01               | N/A        | N/A        |
| 3    | Signal Generator                    | Agilent      | E4438C    | MY49072627                | 2023-06-09 | 2024-06-08 |
| 4    | S-parameter Network Analyzer        | Agilent      | 8753ES    | US38432944                | 2023-06-09 | 2024-06-08 |
| 5    | Wideband Radio Communication Tester | R&S          | CMW500    | 103818-1                  | 2022-10-29 | 2023-10-28 |
| 6    | E-Field PROBE                       | MVG          | SSE2      | SN 25/22<br>EPMO376       | 2023-06-22 | 2024-06-21 |
| 7    | DIPOLE 2450                         | SATIMO       | SID 2450  | SN 07/14 DIP<br>2G450-306 | 2021-09-29 | 2024-09-28 |
| 8    | DIPOLE 5000-6000                    | SATIMO       | SWG5500   | SN 49/16 WGA 43           | 2021-09-22 | 2024-09-21 |
| 9    | COMOSAR OPENCoaxial Probe           | SATIMO       | OCPG 68   | SN 40/14<br>OCPG68        | 2022-10-29 | 2023-10-28 |
| 10   | SAR Locator                         | SATIMO       | VPS51     | SN 40/14 VPS51            | 2022-10-29 | 2023-10-28 |
| 11   | Communication Antenna               | SATIMO       | ANTA57    | SN 39/14 ANTA57           | 2022-10-29 | 2023-10-28 |
| 12   | FEATURE PHONEPOSITIONING DEVICE     | SATIMO       | MSH98     | SN 40/14 MSH98            | N/A        | N/A        |
| 13   | DUMMY PROBE                         | SATIMO       | DP60      | SN 03/14 DP60             | N/A        | N/A        |
| 14   | SAM PHANTOM                         | SATIMO       | SAM117    | SN 40/14<br>SAM117        | N/A        | N/A        |
| 15   | Liquid measurement Kit              | HP           | 85033D    | 3423A03482                | N/A        | N/A        |
| 16   | Power meter                         | Agilent      | E4419B    | MY45104493                | 2022-10-29 | 2023-10-28 |
| 17   | Power meter                         | Agilent      | E4419B    | MY45100308                | 2022-10-29 | 2023-10-28 |
| 18   | Power sensor                        | Agilent      | E9301H    | MY41495616                | 2022-10-29 | 2023-10-28 |
| 19   | Power sensor                        | Agilent      | E9301H    | MY41495234                | 2022-10-29 | 2023-10-28 |
| 20   | Directional Coupler                 | MCLI/USA     | 4426-20   | 03746                     | 2023-06-09 | 2024-06-08 |

### Note:

- 1) Per KDB865664D01 requirements for dipole calibration, the test laboratory has adopted three year extended calibration interval. Each measured dipole is expected to evaluate with following criteria at least on annual interval.
  - a) There is no physical damage on the dipole;
  - b) System check with specific dipole is within 10% of calibrated values;
  - c) The most recent return-loss results, measured at least annually, deviates by no more than 20% from the previous measurement;
  - d) The most recent measurement of the real or imaginary parts of the impedance, measured at least annually is within 5Ω from the previous measurement.
- 2) Network analyzer probe calibration against air, distilled water and a shorting block performed before measuring liquid parameters.



Shenzhen LCS Compliance Testing Laboratory Ltd.

Add: 101, 201 Bldg A & 301 Bldg C, Juji Industrial Park Yabianxueziwei, Shajing Street, Baoan District, Shenzhen, 518000, China

Tel: +(86) 0755-82591330 | E-mail: webmaster@lcs-cert.com | Web: www.lcs-cert.com

Scan code to check authenticity

### 3.SAR MEASUREMENTS SYSTEM CONFIGURATION

#### 3.1. SAR Measurement Set-up

The OPENSAR system for performing compliance tests consist of the following items:

A standard high precision 6-axis robot (KUKA) with controller and software.

KUKA Control Panel (KCP)

A dosimetric probe, i.e., an isotropic E-field probe optimized and calibrated for usage in tissue simulating liquid. The probe is equipped with a Video Positioning System(VPS).

The stress sensor is composed with mechanical and electronic when the electronic part detects a change on the electro-mechanical switch,It sends an "Emergency signal" to the robot controller that to stop robot's moves

A computer operating Windows XP.

OPENSAR software

Remote control with teaches pendant and additional circuitry for robot safety such as warning lamps, etc.

The SAM phantom enabling testing left-hand right-hand and body usage.

The Position device for handheld EUT

Tissue simulating liquid mixed according to the given recipes .

System validation dipoles to validate the proper functioning of the system.

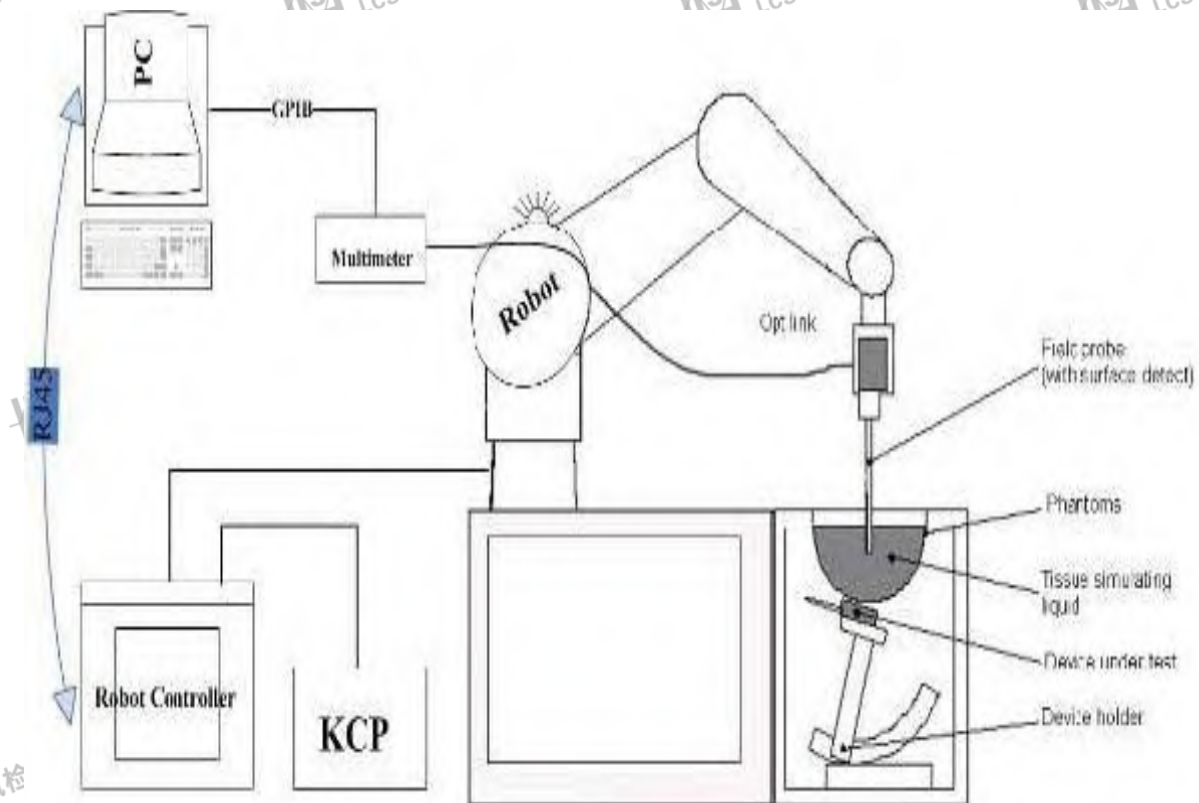



### 3.2. OPENSAR E-field Probe System

The SAR measurements were conducted with the dosimetric probe EPGO376(manufactured by SATIMO), designed in the classical triangular configuration and optimized for dosimetric evaluation.

#### Probe Specification

Construction Symmetrical design with triangular core  
Interleaved sensors  
Built-in shielding against static charges  
PEEK enclosure material (resistant to organic solvents, e.g., DGBE)

Calibration ISO/IEC 17025 calibration service available.

|               |  |
|---------------|--|
| Frequency     | 450 MHz to 6 GHz;<br>Linearity:0.25dB(450 MHz to 6GHz)   |
| Directivity   | 0.25 dB in HSL (rotation around probe axis)<br>0.5 dB in tissue material (rotation normal to probe axis)                   |
| Dynamic Range | 0.01W/kg to > 100 W/kg;<br>Linearity: 0.25 dB  |
| Dimensions    | Overall length: 330 mm (Tip: 16mm)<br>Tip diameter: 5 mm (Body: 8 mm)<br>Distance from probe tip to sensor centers: 2.5 mm |
| Application   | General dosimetry up to 6 GHz<br>Dosimetry in strong gradient fields<br>Compliance tests of Mobile Phones                  |

#### Isotropic E-Field Probe

The isotropic E-Field probe has been fully calibrated and assessed for isotropicity, and boundary effect within a controlled environment. Depending on the frequency for which the probe is calibrated the method utilized for calibration will change.

The E-Field probe utilizes a triangular sensor arrangement as detailed in the diagram below:



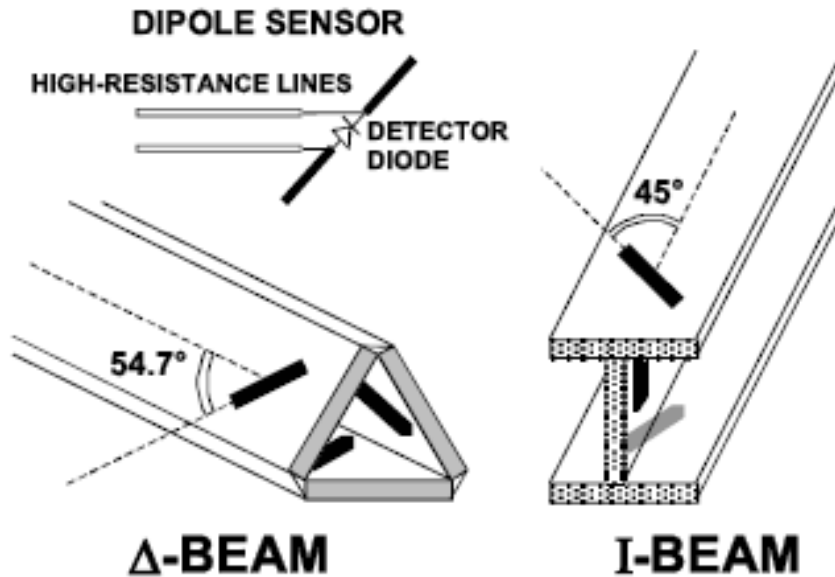

### 3.3. Phantoms

The SAM Phantom SAM117 is constructed of a fiberglass shell integrated in a wooden table. The shape of the shell is in compliance with the specification set in IEEE P1528 and CENELEC EN62209-1, EN62209-2:2010. The phantom enables the dosimetric evaluation of left and right hand phone usage as well as body mounted usage at the flat phantom region. A cover prevents the evaporation of the liquid. Reference markings on the Phantom allow the complete setup of all predefined phantom positions and measurement grids by manually teaching three points in the robot.

System checking was performed using the flat section, whilst Head SAR tests used the left and right head profile sections. Body SAR testing also used the flat section between the head profiles.

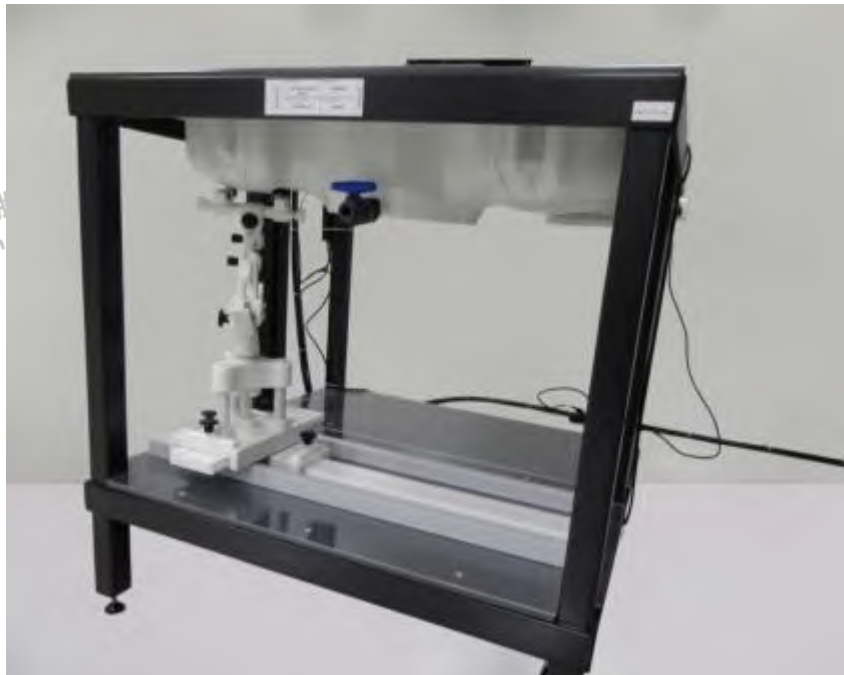

SAM Twin Phantom





### 3.4. Device Holder

In combination with the Generic Twin Phantom SAM117, the Mounting Device enables the rotation of the mounted transmitter in spherical coordinates whereby the rotation points is the ear opening. The devices can be easily, accurately, and repeatedly positioned according to the FCC and CENELEC specifications. The device holder can be locked at different phantom locations (left head, right head, flat phantom).



Device holder supplied by SATIMO

### 3.5. Scanning Procedure

The procedure for assessing the peak spatial-average SAR value consists of the following steps

#### Power Reference Measurement

The reference and drift jobs are useful jobs for monitoring the power drift of the device under test in the batch process. Both jobs measure the field at a specified reference position, at a selectable distance from the phantom surface. The reference position can be either the selected section's grid reference point or a user point in this section. The reference job projects the selected point onto the phantom surface, orients the probe perpendicularly to the surface, and approaches the surface using the selected detection method.

#### Area Scan

The Area Scan is used as a fast scan in two dimensions to find the area of high field values before running a detailed measurement around the hot spot. Before starting the area scan a grid spacing of 15 mm x 15 mm is set. During the scan the distance of the probe to the phantom remains unchanged. After finishing area scan, the field maxima within a range of 2 dB will be ascertained.

|  | ≤ 3 GHz   | > 3 GHz   |
|--|---|---|
| Maximum distance from closest measurement point (geometric center of probe sensors) to phantom surface | 5 mm ± 1 mm   | $\frac{1}{2} \cdot \delta \cdot \ln(2)$ mm ± 0.5 mm |
| Maximum probe angle from probe axis to phantom surface normal at the measurement location              | 30° ± 1°  | 20° ± 1°  |
| Maximum area scan spatial resolution: $\Delta x_{Area}$ , $\Delta y_{Area}$                            | ≤ 2 GHz: ≤ 15 mm<br>2 – 3 GHz: ≤ 12 mm  | 3 – 4 GHz: ≤ 12 mm<br>4 – 6 GHz: ≤ 10 mm            |
|  | When the x or y dimension of the test device, in the measurement plane orientation, is smaller than the above, the measurement resolution must be ≤ the corresponding x or y dimension of the test device with at least one measurement point on the test device. |   |

#### Zoom Scan

Zoom Scans are used to estimate the peak spatial SAR values within a cubic averaging volume containing 1 g





and 10 g of simulated tissue. The default Zoom Scan is done by 7x7x7 points within a cube whose base is centered around the maxima found in the preceding area scan.

|  |                                    |  |   |
|--|------------------------------------|--|---|
| Maximum zoom scan spatial resolution: $\Delta x_{Zoom}, \Delta y_{Zoom}$ |                                    | $\leq 2$ GHz: $\leq 8$ mm<br>2 – 3 GHz: $\leq 5$ mm*                                 | 3 – 4 GHz: $\leq 5$ mm*<br>4 – 6 GHz: $\leq 4$ mm*                            |
| Maximum zoom scan spatial resolution, normal to phantom surface          | uniform grid: $\Delta z_{Zoom}(n)$ | $\leq 5$ mm  | 3 – 4 GHz: $\leq 4$ mm<br>4 – 5 GHz: $\leq 3$ mm<br>5 – 6 GHz: $\leq 2$ mm    |
|  | graded grid                        | $\Delta z_{Zoom}(1)$ : between 1 <sup>st</sup> two points closest to phantom surface | $\leq 4$ mm   |
|  |                                    | $\Delta z_{Zoom}(n>1)$ : between subsequent points                                   | $\leq 1.5 \cdot \Delta z_{Zoom}(n-1)$ mm                                      |
| Minimum zoom scan volume   | x, y, z                            | $\geq 30$ mm   | 3 – 4 GHz: $\geq 28$ mm<br>4 – 5 GHz: $\geq 25$ mm<br>5 – 6 GHz: $\geq 22$ mm |

Note:  $\delta$  is the penetration depth of a plane-wave at normal incidence to the tissue medium; see IEEE Std 1528-2013 for details.

\* When zoom scan is required and the *reported* SAR from the *area scan based 1-g SAR estimation* procedures of KDB Publication 447498 is  $\leq 1.4$  W/kg,  $\leq 8$  mm,  $\leq 7$  mm and  $\leq 5$  mm zoom scan resolution may be applied, respectively, for 2 GHz to 3 GHz, 3 GHz to 4 GHz and 4 GHz to 6 GHz.





### Power Drift measurement

The drift job measures the field at the same location as the most recent reference job within the same procedure, and with the same settings. The drift measurement gives the field difference in dB from the reading conducted within the last reference measurement. Several drift measurements are possible for one reference measurement. This allows a user to monitor the power drift of the device under test within a batch process. In the properties of the Drift job, the user can specify a limit for the drift and have OPENSAR software stop the measurements if this limit is exceeded.

## 3.6. Data Storage and Evaluation

### Data Storage

The OPENSAR software stores the acquired data from the data acquisition electronics as raw data (in microvolt readings from the probe sensors), together with all necessary software parameters for the data evaluation (probe calibration data, liquid parameters and device frequency and modulation data) in measurement files. The software evaluates the desired unit and format for output each time the data is visualized or exported. This allows verification of the complete software setup even after the measurement and allows correction of incorrect parameter settings. For example, if a measurement has been performed with a wrong crest factor parameter in the device setup, the parameter can be corrected afterwards and the data can be re-evaluated.

The measured data can be visualized or exported in different units or formats, depending on the selected probe type ([V/m], [A/m], [°C], [mW/g], [mW/cm²], [dBrel], etc.). Some of these units are not available in certain situations or show meaningless results, e.g., a SAR output in a lossless media will always be zero. Raw data can also be exported to perform the evaluation with other software packages.

### Data Evaluation

The OPENSAR software automatically executes the following procedures to calculate the field units from the microvolt readings at the probe connector. The parameters used in the evaluation are stored in the configuration modules of the software:

- Probe parameters: - Sensitivity Normi, ai0, ai1, ai2
- Conversion factor ConvFi
- Diode compression point Dcpi
- Device parameters: - Frequency f
- Crest factor cf
- Media parameters: - Conductivity σ
- Density ρ

These parameters must be set correctly in the software. They can be found in the component documents or they can be imported into the software from the configuration files issued for the OPENSAR components. In the direct measuring mode of the multimeter option, the parameters of the actual system setup are used. In the scan visualization and export modes, the parameters stored in the corresponding document files are used.

The first step of the evaluation is a linearization of the filtered input signal to account for the compression characteristics of the detector diode. The compensation depends on the input signal, the diode type and the DC-transmission factor from the diode to the evaluation electronics. If the exciting field is pulsed, the crest factor of the signal must be known to correctly compensate for peak power. The formula for each channel can be given as:

$$V_i = U_i + U_i^2 \cdot \frac{cf}{dcp_i}$$

- With  $V_i$  = compensated signal of channel  $i$  ( $i = x, y, z$ )
- $U_i$  = input signal of channel  $i$  ( $i = x, y, z$ )
- cf = crest factor of exciting field
- dcp<sub>i</sub> = diode compression point

From the compensated input signals the primary field data for each channel can be evaluated:

$$E - \text{fieldprobes} : E_i = \sqrt{\frac{V_i}{Norm_i \cdot ConvF}}$$

$$H - \text{fieldprobes} : H_i = \sqrt{V_i \cdot \frac{a_{i0} + a_{i1}f + a_{i2}f^2}{f}}$$

- With  $V_i$  = compensated signal of channel  $i$  ( $i = x, y, z$ )
- Norm<sub>i</sub> = sensor sensitivity of channel  $i$  ( $i = x, y, z$ )



- [mV/(V/m)<sup>2</sup>] for E-field Probes
- ConvF = sensitivity enhancement in solution
- $a_{ij}$  = sensor sensitivity factors for H-field probes
- f = carrier frequency [GHz]
- $E_i$  = electric field strength of channel i in V/m
- $H_i$  = magnetic field strength of channel i in A/m

The RSS value of the field components gives the total field strength (Hermitian magnitude):

$$E_{tot} = \sqrt{E_x^2 + E_y^2 + E_z^2}$$

The primary field data are used to calculate the derived field units.

$$SAR = E_{tot}^2 \cdot \frac{\sigma}{\rho \cdot 1'000}$$

- with SAR = local specific absorption rate in mW/g
- $E_{tot}$  = total field strength in V/m
- $\sigma$  = conductivity in [mho/m] or [Siemens/m]
- $\rho$  = equivalent tissue density in g/cm<sup>3</sup>

Note that the density is normally set to 1 (or 1.06), to account for actual brain density rather than the density of the simulation liquid.

### 3.7. Position of the wireless device in relation to the phantom

#### General considerations

This standard specifies two handset test positions against the head phantom – the “cheek” position and the “tilt” position.

The power flow density is calculated assuming the excitation field as a free space field

$$P_{(pwe)} = \frac{E_{tot}^2}{3770} \text{ or } P_{(pwe)} = H_{tot}^2 \cdot 37.7$$

- Where  $P_{pwe}$  = Equivalent power density of a plane wave in mW/cm<sup>2</sup>
- $E_{tot}$  = total electric field strength in V/m
- $H_{tot}$  = total magnetic field strength in A/m

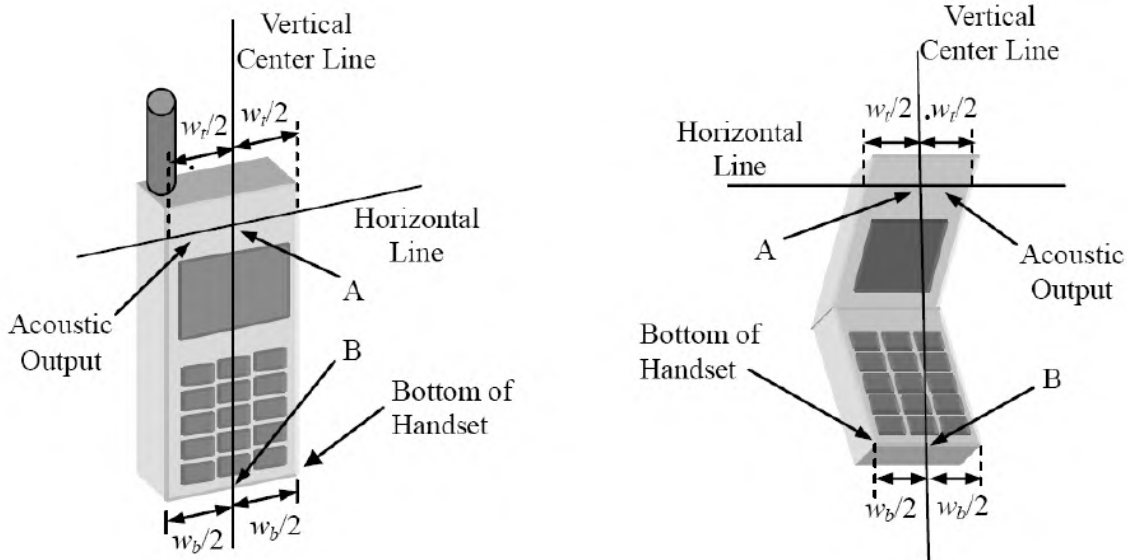

- $W_t$  Width of the handset at the level of the acoustic
- $W_b$  Width of the bottom of the handset
- A Midpoint of the width  $w_t$  of the handset at the level of the acoustic output
- B Midpoint of the width  $w_b$  of the bottom of the handset

Picture 1-a Typical “fixed” case handset    Picture 1-b Typical “clam-shell” case handset





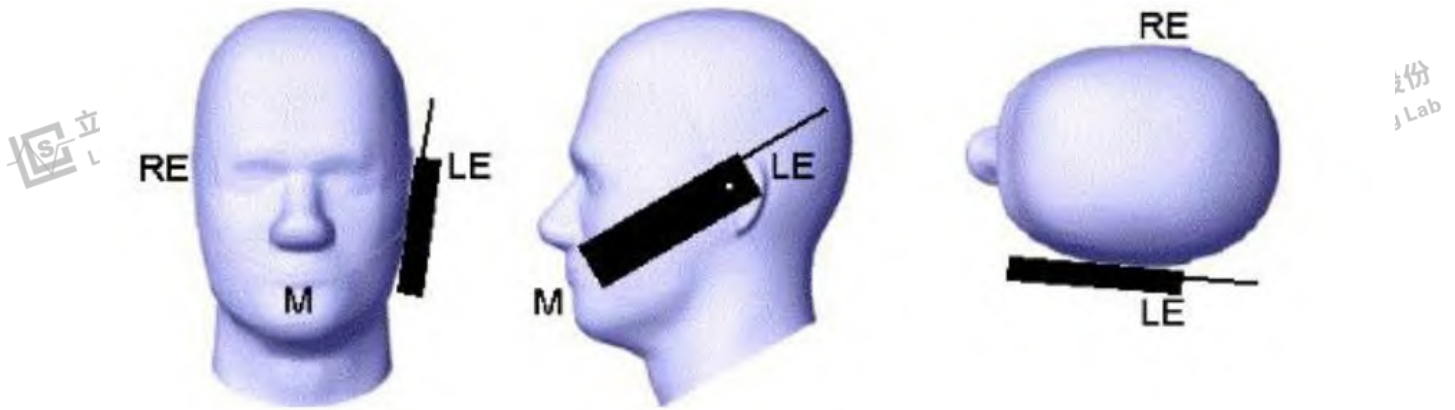

Picture 2 Cheek position of the wireless device on the left side of SAM

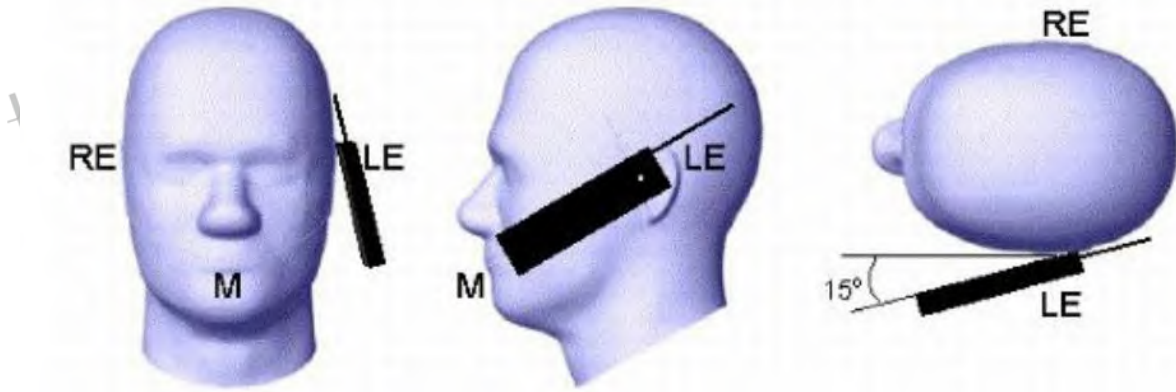

Picture 3 Tilt position of the wireless device on the left side of SAM

For body SAR test we applied to FCC KDB941225, KDB447498, KDB248227, KDB648654;







### 3.8. Tissue Dielectric Parameters for Head and Body Phantoms

The liquid is consisted of water, salt, Glycol, Sugar, Preventol and Cellulose. The liquid has previously been proven to be useful for worst-case. It's satisfying the latest tissue dielectric parameters requirements proposed by the KDB865664.

The composition of the tissue simulating liquid

| Ingredient<br>(%<br>Weight) | 750MHz |      | 835MHz |      | 1800 MHz |       | 1900 MHz |       | 2450MHz |       | 2600MHz |       | 5000MHz |      |
|-----------------------------|--------|------|--------|------|----------|-------|----------|-------|---------|-------|---------|-------|---------|------|
|                             | Head   | Body | Head   | Body | Head     | Body  | Head     | Body  | Head    | Body  | Head    | Body  | Head    | Body |
| Water                       | 39.28  | 51.3 | 41.45  | 52.5 | 54.5     | 40.2  | 54.9     | 40.4  | 62.7    | 73.2  | 60.3    | 71.4  | 65.5    | 78.6 |
| Preventol                   | 0.10   | 0.10 | 0.10   | 0.10 | 0.00     | 0.00  | 0.00     | 0.00  | 0.00    | 0.00  | 0.00    | 0.00  | 0.00    | 0.00 |
| HEC                         | 1.00   | 1.00 | 1.00   | 1.00 | 0.00     | 0.00  | 0.00     | 0.00  | 0.00    | 0.00  | 0.00    | 0.00  | 0.00    | 0.00 |
| DGBE                        | 0.00   | 0.00 | 0.00   | 0.00 | 45.33    | 59.31 | 44.92    | 59.10 | 36.80   | 26.70 | 39.10   | 28.40 | 0.00    | 0.00 |
| Triton X-100                | 0.00   | 0.00 | 0.00   | 0.00 | 0.00     | 0.00  | 0.00     | 0.00  | 0.00    | 0.00  | 0.00    | 0.00  | 17.2    | 10.7 |

| Target Frequency<br>(MHz) | Head         |               |
|---------------------------|--------------|---------------|
|                           | $\epsilon_r$ | $\sigma(S/m)$ |
| 450                       | 43.5         | 0.87          |
| 750                       | 41.9         | 0.89          |
| 835                       | 41.5         | 0.90          |
| 900                       | 41.5         | 0.97          |
| 1450                      | 40.5         | 1.20          |
| 1640                      | 40.2         | 1.31          |
| 1800                      | 40.0         | 1.40          |
| 1900                      | 40.0         | 1.40          |
| 2000                      | 40.0         | 1.40          |
| 2450                      | 39.2         | 1.80          |
| 3000                      | 38.5         | 2.40          |
| 5200                      | 36.0         | 4.66          |
| 5800                      | 35.3         | 5.27          |

### 3.9. Tissue equivalent liquid properties

Dielectric Performance of Head Tissue Simulating Liquid

| Test Engineer: bob.yang |                          |               |              |                 |        |              |        |              |            |
|-------------------------|--------------------------|---------------|--------------|-----------------|--------|--------------|--------|--------------|------------|
| Tissue Type             | Measured Frequency (MHz) | Target Tissue |              | Measured Tissue |        |              |        | Liquid Temp. | Test Data  |
|                         |                          | $\sigma$      | $\epsilon_r$ | $\sigma$        | Dev.   | $\epsilon_r$ | Dev.   |              |            |
| 2450H                   | 2450                     | 1.80          | 39.20        | 1.78            | -1.11% | 39.52        | 0.82%  | 22.6         | 07/14/2023 |
| 5200H                   | 5200                     | 4.66          | 36.00        | 4.68            | 0.43%  | 35.54        | -1.28% | 23.2         | 07/18/2023 |
| 5800H                   | 5800                     | 5.27          | 35.30        | 5.29            | 0.38%  | 35.10        | -0.57% | 22.4         | 07/24/2023 |



### 3.10. System Check

The purpose of the system check is to verify that the system operates within its specifications at the device test frequency. The system check is simple check of repeatability to make sure that the system works correctly at the time of the compliance test;

System check results have to be equal or near the values determined during dipole calibration with the relevant liquids and test system ( $\pm 10\%$ ).

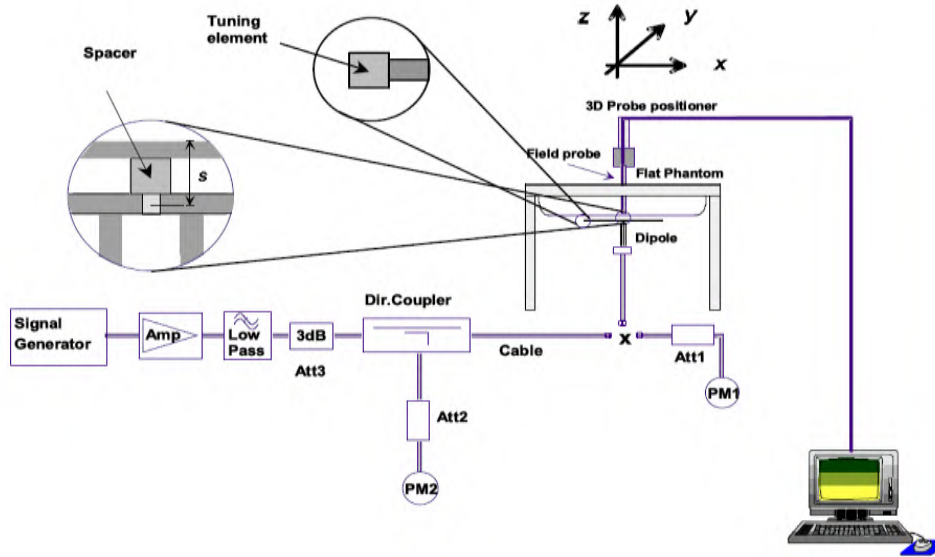

The output power on dipole port must be calibrated to 20 dBm (100mW) before dipole is connected.



Photo of Dipole Setup



**Justification for Extended SAR Dipole Calibrations**

Referring to KDB 865664D01V01r04, if dipoles are verified in return loss (<-20dB, within 20% of prior calibration), and in impedance (within 5 ohm of prior calibration), the annual calibration is not necessary and the calibration interval can be extended. While calibration intervals not exceed 3 years.

SID2450 SN 07/14 DIP 2G450-306 Extend Dipole Calibrations

| Date of Measurement | Return-Loss (dB) | Delta (%) | Real Impedance (ohm) | Delta (ohm) | Imaginary Impedance (ohm) | Delta (ohm) |
|---------------------|------------------|-----------|----------------------|-------------|---------------------------|-------------|
| 2021-09-29          | -25.59           |           | 44.7                 |             | -1.1                      |             |
| 2022-09-29          | -25.68           | 0.35      | 44.8                 | 0.1         | -1.0                      | 0.1         |

SID5200 SN 49/16 DIP WGA43 Extend Dipole Calibrations

| Date of Measurement | Return-Loss (dB) | Delta (%) | Real Impedance (ohm) | Delta (ohm) | Imaginary Impedance (ohm) | Delta (ohm) |
|---------------------|------------------|-----------|----------------------|-------------|---------------------------|-------------|
| 2021-09-22          | -8.59            |           | 19.38                |             | 13.50                     |             |
| 2022-09-22          | -8.62            | 0.35      | 19.25                | -0.13       | 13.47                     | -0.03       |

SID5800 SN 49/16 DIP WGA43 Extend Dipole Calibrations

| Date of Measurement | Return-Loss (dB) | Delta (%) | Real Impedance (ohm) | Delta (ohm) | Imaginary Impedance (ohm) | Delta (ohm) |
|---------------------|------------------|-----------|----------------------|-------------|---------------------------|-------------|
| 2021-09-22          | -11.37           |           | 54.79                |             | 25.47                     |             |
| 2022-09-22          | -11.42           | 0.44      | 54.68                | -0.11       | 25.26                     | -0.21       |

| Mixture Type | Frequency (MHz) | Power               | SAR <sub>1g</sub> (W/Kg) | SAR <sub>10g</sub> (W/Kg) | Drift (%) | 1W Target                |                           | Difference percentage |        | Liquid Temp | Date       |
|--------------|-----------------|---------------------|--------------------------|---------------------------|-----------|--------------------------|---------------------------|-----------------------|--------|-------------|------------|
|              |                 |                     |                          |                           |           | SAR <sub>1g</sub> (W/Kg) | SAR <sub>10g</sub> (W/Kg) | 1g                    | 10g    |             |            |
| Head         | 2450            | 100 mW              | 5.435                    | 2.505                     | 3.26      | 53.89                    | 24.15                     | 0.85%                 | 3.73%  | 22.6        | 07/14/2023 |
|              |                 | Normalize to 1 Watt | 54.35                    | 25.05                     |           |                          |                           |                       |        |             |            |
| Head         | 5200            | 100 mW              | 15.598                   | 5.565                     | -1.14     | 165.77                   | 57.2                      | -5.91%                | -2.71% | 23.2        | 07/18/2023 |
|              |                 | Normalize to 1 Watt | 155.98                   | 55.65                     |           |                          |                           |                       |        |             |            |
| Head         | 5800            | 100 mW              | 18.277                   | 6.190                     | -3.32     | 186.77                   | 62.84                     | -2.14%                | -1.50% | 22.4        | 07/24/2023 |
|              |                 | Normalize to 1 Watt | 182.77                   | 61.90                     |           |                          |                           |                       |        |             |            |



Shenzhen LCS Compliance Testing Laboratory Ltd.

Add: 101, 201 Bldg A &amp; 301 Bldg C, Juji Industrial Park Yabianxueziwei, Shajing Street, Baoan District, Shenzhen, 518000, China

Tel: +(86) 0755-82591330 | E-mail: webmaster@lcs-cert.com | Web: www.lcs-cert.com

Scan code to check authenticity

### 3.11. SAR measurement procedure

The measurement procedures are as follows:

#### 3.11.1 Conducted power measurement

- For WWAN power measurement, use base station simulator connection with RF cable, at maximum power in each supported wireless interface and frequency band.
- Read the WWAN RF power level from the base station simulator.
- For WLAN/BT power measurement, use engineering software to configure EUT WLAN/BT continuously Transmission, at maximum RF power in each supported wireless interface and frequency band.
- Connect EUT RF port through RF cable to the power meter, and measure WLAN/BT output power.

#### 3.11.2 WIFI Test Configuration

The SAR measurement and test reduction procedures are structured according to either the DSSS or OFDM transmission mode configurations used in each standalone frequency band and aggregated band. For devices that operate in exposure configurations that require multiple test positions, additional SAR test reduction may be applied. The maximum output power specified for production units, including tune-up tolerance, are used to determine initial SAR test requirements for the 802.11 transmission modes in a frequency band. SAR is measured using the highest measured maximum output power channel for the initial test configuration. SAR measurement and test reduction for the remaining 802.11 modes and test channels are determined according to measured or specified maximum output power and reported SAR of the initial measurements. The general test reduction and SAR measurement approaches are summarized in the following:

- The maximum output power specified for production units are determined for all applicable 802.11 transmission modes in each standalone and aggregated frequency band. Maximum output power is measured for the highest maximum output power configuration(s) in each frequency band according to the default power measurement procedures.
- For OFDM transmission configurations in the 2.4 GHz and 5 GHz bands, an "initial test configuration" is first determined for each standalone and aggregated frequency band according to the maximum output power and tune-up tolerance specified for production units.
  - When the same maximum power is specified for multiple transmission modes in a frequency band, the largest channel bandwidth, lowest order modulation, lowest data rate and lowest order 802.11 a/g/n/ac mode is used for SAR measurement, on the highest measured output power channel in the initial test configuration, for each frequency band.
  - SAR is measured for OFDM configurations using the initial test configuration procedures. Additional frequency band specific SAR test reduction may be considered for individual frequency bands
  - Depending on the reported SAR of the highest maximum output power channel tested in the initial test configuration, SAR test reduction may apply to subsequent highest output channels in the initial test configuration to reduce the number of SAR measurements.
- The Initial test configuration does not apply to DSSS. The 2.4 GHz band SAR test requirements and 802.11b DSSS procedures are used to establish the transmission configurations required for SAR measurement.
- An "initial test position" is applied to further reduce the number of SAR tests for devices operating in next to the ear, UMPC mini-tablet or hotspot mode exposure configurations that require multiple test positions.
  - SAR is measured for 802.11b according to the 2.4 GHz DSSS procedure using the exposure condition established by the initial test position.
  - SAR is measured for 2.4 GHz and 5 GHz OFDM configurations using the initial test configuration. 802.11b/g/n operating modes are tested independently according to the service requirements in each frequency band. 802.11b/g/n modes are tested on the maximum average output channel.
- The Initial test position does not apply to devices that require a fixed exposure test position. SAR is measured in a fixed exposure test position for these devices in 802.11b according to the 2.4 GHz DSSS procedure or in 2.4 GHz and 5 GHz OFDM configurations using the initial test configuration procedures.
- The "subsequent test configuration" procedures are applied to determine if additional SAR measurements are required for the remaining OFDM transmission modes that have not been tested in the initial test configuration. SAR test exclusion is determined according to reported SAR in the initial test configuration and maximum output power specified or measured for these other OFDM configurations.

#### 2.4 GHz and 5GHz SAR Procedures

Separate SAR procedures are applied to DSSS and OFDM configurations in the 2.4 GHz band to simplify DSSS test requirements. For 802.11b DSSS SAR measurements, DSSS SAR procedure applies to fixed exposure test position and initial test position procedure applies to multiple exposure test positions. When SAR measurement is required for an OFDM configuration, the initial test configuration, subsequent test configuration and initial test







position procedures are applied. The SAR test exclusion requirements for 802.11g/n OFDM configurations are described in section 5.2.2.

#### 1. 802.11b DSSS SAR Test Requirements

SAR is measured for 2.4 GHz 802.11b DSSS using either a fixed test position or, when applicable, the initial test position procedure. SAR test reduction is determined according to the following:

- a. When the reported SAR of the highest measured maximum output power channel (section 3.1) for the exposure configuration is  $\leq 0.8$  W/kg, no further SAR testing is required for 802.11b DSSS in that exposure configuration.
- b. When the reported SAR is  $> 0.8$  W/kg, SAR is required for that exposure configuration using the next highest measured output power channel. When any reported SAR is  $> 1.2$  W/kg, SAR is required for the third channel; i.e., all channels require testing.

#### 1. 2.4 GHz 802.11g/n OFDM SAR Test Exclusion Requirements

When SAR measurement is required for 2.4 GHz 802.11g/n OFDM configurations, the measurement and test reduction procedures for OFDM are applied (section 5.3). SAR is not required for the following 2.4 GHz OFDM conditions.

- a. When KDB Publication 447498 SAR test exclusion applies to the OFDM configuration
- b. When the highest reported SAR for DSSS is adjusted by the ratio of OFDM to DSSS specified maximum output power and the adjusted SAR is  $\leq 1.2$  W/kg.

#### 2. SAR Test Requirements for OFDM Configurations

When SAR measurement is required for 802.11 a/g/n/ac OFDM configurations, each standalone and frequency aggregated band is considered separately for SAR test reduction. When the same transmitter and antenna(s) are used for U-NII-1 and U-NII-2A bands, additional SAR test reduction applies. When band gap channels between U-NII-2C band and 5.8 GHz U-NII-3 or §15.247 band are supported, the highest maximum output power transmission mode configuration and maximum output power channel across the bands must be used to determine SAR test reduction, according to the initial test configuration and subsequent test configuration requirements.<sup>20</sup> In applying the initial test configuration and subsequent test configuration procedures, the 802.11 transmission configuration with the highest specified maximum output power and the channel within a test configuration with the highest measured maximum output power should be clearly distinguished to apply the procedures.

#### 3. OFDM Transmission Mode SAR Test Configuration and Channel Selection Requirements

The initial test configuration for 2.4 GHz and 5 GHz OFDM transmission modes is determined by the 802.11 configuration with the highest maximum output power specified for production units, including tune-up tolerance, in each standalone and aggregated frequency band. SAR for the initial test configuration is measured using the highest maximum output power channel determined by the default power measurement procedures (section 4). When multiple configurations in a frequency band have the same specified maximum output power, the initial test configuration is determined according to the following steps applied sequentially.

- a. The largest channel bandwidth configuration is selected among the multiple configurations with the same specified maximum output power.
- b. If multiple configurations have the same specified maximum output power and largest channel bandwidth, the lowest order modulation among the largest channel bandwidth configurations is selected.
- c. If multiple configurations have the same specified maximum output power, largest channel bandwidth and lowest order modulation, the lowest data rate configuration among these configurations is selected.
- d. When multiple transmission modes (802.11a/g/n/ac) have the same specified maximum output power, largest channel bandwidth, lowest order modulation and lowest data rate, the lowest order 802.11 mode is selected; i.e., 802.11a is chosen over 802.11n then 802.11ac or 802.11g is chosen over 802.11n.

After an initial test configuration is determined, if multiple test channels have the same measured maximum output power, the channel chosen for SAR measurement is determined according to the following. These channel selection procedures apply to both the initial test configuration and subsequent test configuration(s), with respect to the default power measurement procedures or additional power measurements required for further SAR test reduction. The same procedures also apply to subsequent highest output power channel(s) selection.

- a. Channels with measured maximum output power within  $\frac{1}{4}$  dB of each other are considered to have the same maximum output.
- b. When there are multiple test channels with the same measured maximum output power, the channel closest to mid-band frequency is selected for SAR measurement.
- c. When there are multiple test channels with the same measured maximum output power and equal separation from mid-band frequency; for example, high and low channels or two mid-band channels, the higher frequency (number) channel is selected for SAR measurement.

#### Initial Test Configuration Procedures

An initial test configuration is determined for OFDM transmission modes according to the channel bandwidth, modulation and data rate combination(s) with the highest maximum output power specified for production units in each standalone and aggregated frequency band. SAR is measured using the highest measured maximum



Shenzhen LCS Compliance Testing Laboratory Ltd.

Add: 101, 201 Bldg A & 301 Bldg C, Juji Industrial Park Yabianxueziwei, Shajing Street, Baoan District, Shenzhen, 518000, China

Tel: +(86) 0755-82591330 | E-mail: webmaster@lcs-cert.com | Web: www.lcs-cert.com

Scan code to check authenticity



output power channel. For configurations with the same specified or measured maximum output power, additional transmission mode and test channel selection procedures are required (see section 5.3.2). SAR test reduction of subsequent highest output test channels is based on the reported SAR of the initial test configuration. For next to the ear, hotspot mode and UMC mini-tablet exposure configurations where multiple test positions are required, the initial test position procedure is applied to minimize the number of test positions required for SAR measurement using the initial test configuration transmission mode.<sup>23</sup> For fixed exposure conditions that do not have multiple SAR test positions, SAR is measured in the transmission mode determined by the initial test configuration. When the reported SAR of the initial test configuration is  $> 0.8$  W/kg, SAR measurement is required for the subsequent next highest measured output power channel(s) in the initial test configuration until the reported SAR is  $\leq 1.2$  W/kg or all required channels are tested.

#### 4. Subsequent Test Configuration Procedures

SAR measurement requirements for the remaining 802.11 transmission mode configurations that have not been tested in the initial test configuration are determined separately for each standalone and aggregated frequency band, in each exposure condition, according to the maximum output power specified for production units. The initial test position procedure is applied to next to the ear, UMPC mini-tablet and hotspot mode configurations. When the same maximum output power is specified for multiple transmission modes, the procedures in section 5.3.2 are applied to determine the test configuration. Additional power measurements may be required to determine if SAR measurements are required for subsequent highest output power channels in a subsequent test configuration. The subsequent test configuration and SAR measurement procedures are described in the following.

- a. When SAR test exclusion provisions of KDB Publication 447498 are applicable and SAR measurement is not required for the initial test configuration, SAR is also not required for the next highest maximum output power transmission mode subsequent test configuration(s) in that frequency band or aggregated band and exposure configuration.
- b. When the highest reported SAR for the initial test configuration (when applicable, include subsequent highest output channels), according to the initial test position or fixed exposure position requirements, is adjusted by the ratio of the subsequent test configuration to initial test configuration specified maximum output power and the adjusted SAR is  $\leq 1.2$  W/kg, SAR is not required for that subsequent test configuration.
- c. The number of channels in the initial test configuration and subsequent test configuration can be different due to differences in channel bandwidth. When SAR measurement is required for a subsequent test configuration and the channel bandwidth is smaller than that in the initial test configuration, all channels in the subsequent test configuration that overlap with the larger bandwidth channel tested in the initial test configuration should be used to determine the highest maximum output power channel. This step requires additional power measurement to identify the highest maximum output power channel in the subsequent test configuration to determine SAR test reduction.
  - 1). SAR should first be measured for the channel with highest measured output power in the subsequent test configuration.
  - 2). SAR for subsequent highest measured maximum output power channels in the subsequent test configuration is required only when the reported SAR of the preceding higher maximum output power channel(s) in the subsequent test configuration is  $> 1.2$  W/kg or until all required channels are tested.
    - a) For channels with the same measured maximum output power, SAR should be measured using the channel closest to the center frequency of the larger channel bandwidth channel in the initial test configuration.
    - d. SAR measurements for the remaining highest specified maximum output power OFDM transmission mode configurations that have not been tested in the initial test configuration (highest maximum output) or subsequent test configuration(s) (subsequent next highest maximum output power) is determined by applying the subsequent test configuration procedures in this section to the remaining configurations according to the following:
      - 1) replace "subsequent test configuration" with "next subsequent test configuration" (i.e., subsequent next highest specified maximum output power configuration)
      - 2) replace "initial test configuration" with "all tested higher output power configurations."





### 3.12. Power Reduction

The product without any power reduction.

### 3.13. Power Drift

To control the output power stability during the SAR test, SAR system calculates the power drift by measuring the E-field at the same location at the beginning and at the end of the measurement for each test position. This ensures that the power drift during one measurement is within 5%.





## 4. TEST CONDITIONS AND RESULTS

### 4.1. Conducted Power Results

According KDB 447498D01 General RF Exposure Guidance v06 Section 4.1 2) states that "Unless it is specified differently in the published RF exposure KDB procedures, these requirements also apply to test reduction and test exclusion considerations. Time-averaged maximum conducted output power applies to SAR and, as required by § 2.1091(c), time-averaged ERP applies to MPE. When an antenna port is not available on the device to support conducted power measurement, such as FRS and certain Part 15 transmitters with built-in integral antennas, the maximum output power allowed for production units should be used to determine RF exposure test exclusion and compliance."

#### <WLAN 2.4GHz Conducted Power>

| Mode              | Channel | Frequency (MHz) | Average Output Power (dBm) |
|-------------------|---------|-----------------|----------------------------|
| IEEE 802.11b      | 1       | 2412            | 13.54                      |
|                   | 6       | 2437            | 13.30                      |
|                   | 11      | 2462            | 13.13                      |
| IEEE 802.11g      | 1       | 2412            | 9.64                       |
|                   | 6       | 2437            | 9.69                       |
|                   | 11      | 2462            | 9.64                       |
| IEEE 802.11n HT20 | 1       | 2412            | 6.24                       |
|                   | 6       | 2437            | 6.79                       |
|                   | 11      | 2462            | 6.26                       |
| IEEE 802.11n HT40 | 3       | 2422            | 3.54                       |
|                   | 6       | 2437            | 3.72                       |
|                   | 9       | 2452            | 3.60                       |

**Note:** SAR is required for the following 2.4 GHz OFDM conditions as the highest reported SAR for DSSS is adjusted by the ratio of OFDM to DSSS specified maximum output power and the adjusted SAR is  $\leq 1.2$  W/kg.

#### <WLAN 5.2G Conducted Power>

| Mode                | Channel | Frequency (MHz) | Conducted Output Power (dBm) | Worst Case Test Rate Data |
|---------------------|---------|-----------------|------------------------------|---------------------------|
| IEEE 802.11a        | 36      | 5180            | 13.26                        | MCS0                      |
|                     | 40      | 5200            | 13.32                        | MCS0                      |
|                     | 48      | 5240            | 13.42                        | MCS0                      |
| IEEE 802.11n HT20   | 36      | 5180            | 13.09                        | MCS0                      |
|                     | 40      | 5200            | 13.12                        | MCS0                      |
|                     | 48      | 5240            | 13.26                        | MCS0                      |
| IEEE 802.11n HT40   | 38      | 5190            | 12.95                        | MCS0                      |
|                     | 46      | 5230            | 13.10                        | MCS0                      |
| IEEE 802.11ac VHT20 | 36      | 5180            | 13.05                        | MCS0                      |
|                     | 40      | 5200            | 13.04                        | MCS0                      |
|                     | 48      | 5240            | 13.26                        | MCS0                      |
| IEEE 802.11ac VHT40 | 38      | 5190            | 12.98                        | MCS0                      |
|                     | 46      | 5230            | 13.02                        | MCS0                      |
| IEEE 802.11ac VHT80 | 42      | 5210            | 13.31                        | MCS0                      |





## &lt;WLAN 5.8GHz Conducted Power&gt;

| Mode            | Channel | Frequency (MHz) | Conducted Output Power(dBm) |
|-----------------|---------|-----------------|-----------------------------|
| 802.11a         | 149     | 5745            | 13.32                       |
|                 | 157     | 5785            | 12.64                       |
|                 | 165     | 5825            | 12.60                       |
| 802.11n(20MHz)  | 149     | 5745            | 12.44                       |
|                 | 157     | 5785            | 12.54                       |
|                 | 165     | 5825            | 12.40                       |
| 802.11n(40MHz)  | 151     | 5755            | 12.53                       |
|                 | 159     | 5795            | 11.95                       |
| 802.11ac(20MHz) | 149     | 5745            | 12.86                       |
|                 | 157     | 5785            | 12.54                       |
|                 | 165     | 5825            | 12.33                       |
| 802.11ac(40MHz) | 151     | 5755            | 12.49                       |
|                 | 159     | 5795            | 11.95                       |
| 802.11ac(80MHz) | 155     | 5775            | 12.30                       |

## &lt;BT Conducted Power&gt;

| Mode      | channel | Frequency (MHz) | Conducted AVG output power (dBm) |
|-----------|---------|-----------------|----------------------------------|
| BLE       | 0       | 2402            | 2.34                             |
|           | 20      | 2442            | 3.79                             |
|           | 39      | 2480            | 3.29                             |
| GFSK      | 0       | 2402            | 1.36                             |
|           | 39      | 2441            | 2.86                             |
|           | 78      | 2480            | 2.41                             |
| π/4-DQPSK | 0       | 2402            | 1.16                             |
|           | 39      | 2441            | 2.59                             |
|           | 78      | 2480            | 2.18                             |
| 8DPSK     | 0       | 2402            | 1.31                             |
|           | 39      | 2441            | 2.84                             |
|           | 78      | 2480            | 2.35                             |

Per KDB 447498 D01v06, the 1-g and 10-g SAR test exclusion thresholds for 100 MHz to 6 GHz at test separation distances  $\leq 50$  mm are determined by:

$[(\text{max. power of channel, including tune-up tolerance, mW}) / (\text{min. test separation distance, mm})] \cdot [\sqrt{f(\text{GHz})}] \leq 3.0$  for 1-g SAR and  $\leq 7.5$  for 10-g extremity SAR

- $f(\text{GHz})$  is the RF channel transmit frequency in GHz
- Power and distance are rounded to the nearest mW and mm before calculation
- The result is rounded to one decimal place for comparison

| Bluetooth Turn up Power (dBm) | Separation Distance (mm) | Frequency (GHz) | Exclusion Thresholds |
|-------------------------------|--------------------------|-----------------|----------------------|
| 4.0                           | 5                        | 2.45            | 0.8                  |

Per KDB 447498 D01v06, when the minimum test separation distance is  $< 5$  mm, a distance of 5 mm is applied to determine SAR test exclusion. The test exclusion threshold is  $0.8 < 3.0$ , SAR testing is not required.



Shenzhen LCS Compliance Testing Laboratory Ltd.

Add: 101, 201 Bldg A & 301 Bldg C, Juji Industrial Park Yabianxueziwei, Shajing Street, Baoan District, Shenzhen, 518000, China

Tel: +(86) 0755-82591330 | E-mail: webmaster@lcs-cert.com | Web: www.lcs-cert.com

Scan code to check authenticity



## 4.2. Manufacturing tolerance

## WiFi 2.4G

| 802.11b (Average)      |           |           |            |
|------------------------|-----------|-----------|------------|
| Channel                | Channel 1 | Channel 7 | Channel 13 |
| Target (dBm)           | 13.0      | 12.5      | 12.5       |
| Tolerance $\pm$ (dB)   | 1.0       | 1.0       | 1.0        |
| 802.11g (Average)      |           |           |            |
| Channel                | Channel 1 | Channel 7 | Channel 13 |
| Target (dBm)           | 9.0       | 9.0       | 9.0        |
| Tolerance $\pm$ (dB)   | 1.0       | 1.0       | 1.0        |
| 802.11n HT20 (Average) |           |           |            |
| Channel                | Channel 1 | Channel 7 | Channel 13 |
| Target (dBm)           | 5.5       | 6.0       | 5.5        |
| Tolerance $\pm$ (dB)   | 1.0       | 1.0       | 1.0        |
| 802.11n HT40 (Average) |           |           |            |
| Channel                | Channel 3 | Channel 7 | Channel 11 |
| Target (dBm)           | 3.0       | 3.0       | 3.0        |
| Tolerance $\pm$ (dB)   | 1.0       | 1.0       | 1.0        |

## WLAN 5.2G

| IEEE 802.11a (Average)        |            |            |            |
|-------------------------------|------------|------------|------------|
| Channel                       | Channel 36 | Channel 40 | Channel 48 |
| Target (dBm)                  | 12.5       | 12.5       | 12.5       |
| Tolerance $\pm$ (dB)          | 1.0        | 1.0        | 1.0        |
| IEEE 802.11n HT20 (Average)   |            |            |            |
| Channel                       | Channel 36 | Channel 40 | Channel 48 |
| Target (dBm)                  | 12.5       | 12.5       | 12.5       |
| Tolerance $\pm$ (dB)          | 1.0        | 1.0        | 1.0        |
| IEEE 802.11n HT40 (Average)   |            |            |            |
| Channel                       | Channel 38 | Channel 46 |            |
| Target (dBm)                  | 12.0       | 12.5       |            |
| Tolerance $\pm$ (dB)          | 1.0        | 1.0        |            |
| IEEE 802.11ac VHT20 (Average) |            |            |            |
| Channel                       | Channel 36 | Channel 40 | Channel 48 |
| Target (dBm)                  | 12.5       | 12.5       | 12.5       |
| Tolerance $\pm$ (dB)          | 1.0        | 1.0        | 1.0        |
| IEEE 802.11ac VHT40 (Average) |            |            |            |
| Channel                       | Channel 38 | Channel 46 |            |
| Target (dBm)                  | 12.0       | 12.5       |            |
| Tolerance $\pm$ (dB)          | 1.0        | 1.0        |            |
| IEEE 802.11ac VHT80 (Average) |            |            |            |
| Channel                       | Channel 42 |            |            |
| Target (dBm)                  | 12.5       |            |            |
| Tolerance $\pm$ (dB)          | 1.0        |            |            |

## WiFi 5.8G

| 802.11a (Average)        |             |             |             |
|--------------------------|-------------|-------------|-------------|
| Channel                  | Channel 149 | Channel 157 | Channel 165 |
| Target (dBm)             | 12.5        | 12.0        | 12.0        |
| Tolerance $\pm$ (dB)     | 1.0         | 1.0         | 1.0         |
| 802.11n(20MHz) (Average) |             |             |             |
| Channel                  | Channel 149 | Channel 157 | Channel 165 |
| Target (dBm)             | 11.5        | 12.0        | 11.5        |
| Tolerance $\pm$ (dB)     | 1.0         | 1.0         | 1.0         |
| 802.11n(40MHz)           |             |             |             |
| Channel                  | Channel 151 | Channel 159 |             |
| Target (dBm)             | 12.0        | 11.0        |             |



Shenzhen LCS Compliance Testing Laboratory Ltd.

Add: 101, 201 Bldg A &amp; 301 Bldg C, Juji Industrial Park Yabianxueziwei, Shajing Street, Baoan District, Shenzhen, 518000, China

Tel: +(86) 0755-82591330 | E-mail: webmaster@lcs-cert.com | Web: www.lcs-cert.com

Scan code to check authenticity





|                        |             |             |
|------------------------|-------------|-------------|
| Tolerance $\pm$ (dB)   | 1.0         | 1.0         |
| <b>802.11ac(20MHz)</b> |             |             |
| Channel                | Channel 149 | Channel 157 |
| Target (dBm)           | 12.0        | 11.5        |
| Tolerance $\pm$ (dB)   | 1.0         | 1.0         |
| <b>802.11ac(40MHz)</b> |             |             |
| Channel                | Channel 151 | Channel 159 |
| Target (dBm)           | 11.5        | 11.0        |
| Tolerance $\pm$ (dB)   | 1.0         | 1.0         |
| <b>802.11ac(80MHz)</b> |             |             |
| Channel                | Channel 155 |             |
| Target (dBm)           | 11.5        |             |
| Tolerance $\pm$ (dB)   | 1.0         |             |

**Bluetooth V5.0**

|  |           |            |            |
|--|-----------|------------|------------|
| <b>BLE-GFSK (Average)</b>                |           |            |            |
| Channel                                  | Channel 0 | Channel 19 | Channel 39 |
| Target (dBm)                             | 1.5       | 3.0        | 2.5        |
| Tolerance $\pm$ (dB)                     | 1.0       | 1.0        | 1.0        |
| <b>GFSK (Average)</b>                    |           |            |            |
| Channel                                  | Channel 0 | Channel 39 | Channel 78 |
| Target (dBm)                             | 0.5       | 2.0        | 1.5        |
| Tolerance $\pm$ (dB)                     | 1.0       | 1.0        | 1.0        |
| <b><math>\pi</math>/4DQPSK (Average)</b> |           |            |            |
| Channel                                  | Channel 0 | Channel 39 | Channel 78 |
| Target (dBm)                             | 0.5       | 2.0        | 1.5        |
| Tolerance $\pm$ (dB)                     | 1.0       | 1.0        | 1.0        |
| <b>8DPSK (Average)</b>                   |           |            |            |
| Channel                                  | Channel 0 | Channel 39 | Channel 78 |
| Target (dBm)                             | 0.5       | 2.0        | 1.5        |
| Tolerance $\pm$ (dB)                     | 1.0       | 1.0        | 1.0        |



### 4.3. Transmit Antennas and SAR Measurement Position

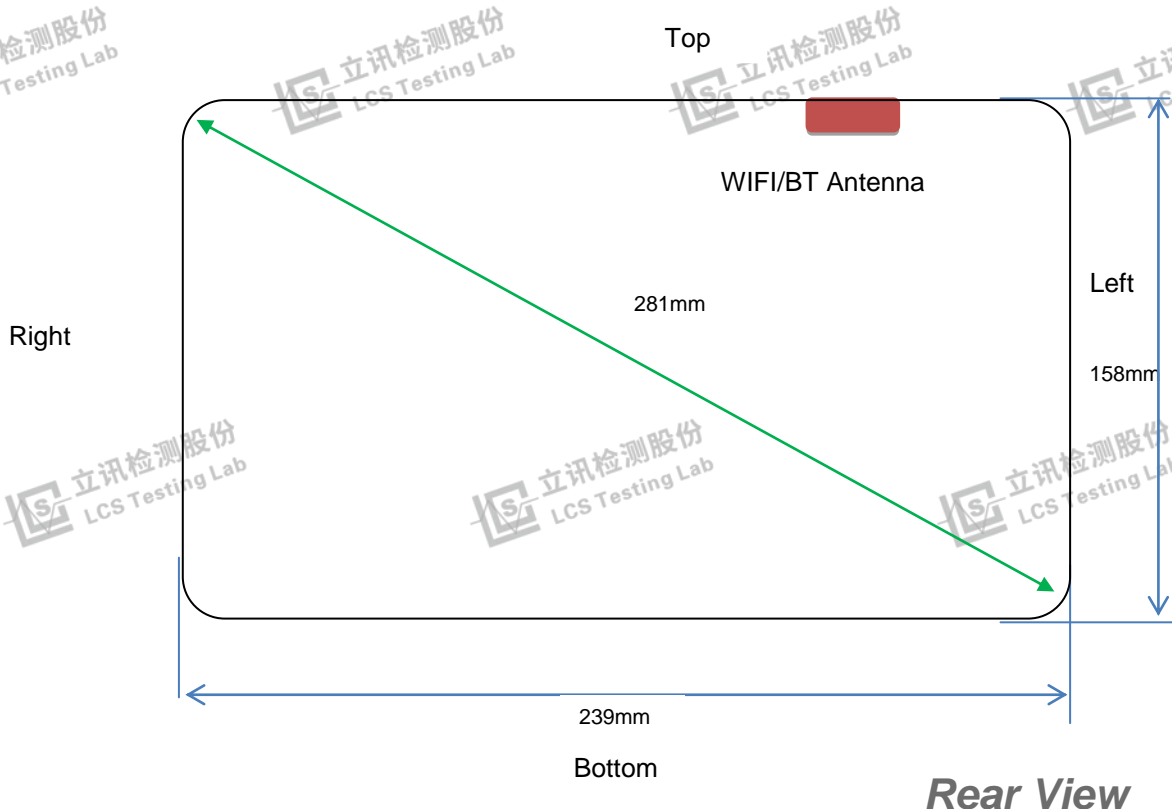

Antenna information:

|                 |               |
|-----------------|---------------|
| WLAN/BT Antenna | WLAN/BT TX/RX |
|-----------------|---------------|

Note:

- 1). Per KDB648474 D04, because the overall diagonal distance of this devices is 281mm>160mm, it is considered as "TABLET PC" device.
- 2). Per KDB648474 D04, 10-g extremity SAR is not required when Body-Worn mode 1-g reported SAR < 1.2 W/Kg.
- 3). According to the KDB941225 D06 Hot Spot SAR v02, the edges with less than 25 mm distance to the antennas need to be tested for SAR.
- 4). Per KDB 616217 D04, The antennas in tablets are typically located near the back (bottom) surface and/or along the edges of the devices; therefore, SAR evaluation is required for these configurations. Exposures from antennas through the front (top) surface of the displaysection of a full-size tablet, away from the edges, are generally limited to the user's hands.

| Distance of The Antenna to the EUT surface and edge (mm) |      |          |             |           |            |
|--|------|----------|-------------|-----------|------------|
| Antennas   | Back | Top Side | Bottom Side | Left Side | Right Side |
| BT/WLAN  | <5   | <5       | 145         | 74        | 130        |

| Positions for SAR tests; Hotspot mode |      |          |             |           |            |
|---------------------------------------|------|----------|-------------|-----------|------------|
| Antennas                              | Back | Top Side | Bottom Side | Left Side | Right Side |
| BT/WLAN                               | Yes  | Yes      | No          | No        | No         |

**General Note:** Referring to KDB 941225 D06 v02, When the overall device length and width are ≥9cm\*5cm, the test distance is 10mm, SAR must be measured for all sides and surfaces with a transmitting antenna located with 25mm from that surface or edge.





#### 4.4. SAR Measurement Results

The calculated SAR is obtained by the following formula:

$$\text{Reported SAR} = \text{Measured SAR} * 10^{(P_{\text{target}} - P_{\text{measured}})/10}$$

$$\text{Scaling factor} = 10^{(P_{\text{target}} - P_{\text{measured}})/10}$$

$$\text{Reported SAR} = \text{Measured SAR} * \text{Scaling factor}$$

Where

$P_{\text{target}}$  is the power of manufacturing upper limit;

$P_{\text{measured}}$  is the measured power;

Measured SAR is measured SAR at measured power which including power drift)

Reported SAR which including Power Drift and Scaling factor

##### Duty Cycle

| Test Mode          | Duty Cycle |
|--------------------|------------|
| WLAN2450/5200/5800 | 1:1        |

#### 4.4.1 SAR Results

##### SAR Values [WIFI2.4G]

| Ch.   | Freq. (MHz) | Service | Test Position | Conducted Power (dBm) | Maximum Allowed Power (dBm) | Power Drift (%) | Scaling Factor | SAR1-g results(W/kg) |          | Graph Results |
|---|-------------|---------|---------------|-----------------------|-----------------------------|-----------------|----------------|----------------------|----------|---------------|
|   |             |         |               |                       |                             |                 |                | Measured             | Reported |               |
| measured / reported SAR numbers - Body (distance 0mm) |             |         |               |                       |                             |                 |                |                      |          |               |
| 1   | 2412        | 802.11b | Rear          | 13.54                 | 14.00                       | 2.24            | 1.112          | 0.275                | 0.306    | Plot 1        |
| 1   | 2412        | 802.11b | Top           | 13.54                 | 14.00                       | 1.14            | 1.112          | 0.257                | 0.286    |               |

##### SAR Values [5.2G]

| Ch.   | Freq. (MHz) | Service        | Test Position | Conducted Power (dBm) | Maximum Allowed Power (dBm) | Power Drift (%) | Scaling Factor | SAR1-g results(W/kg) |          | Graph Results |
|---|-------------|----------------|---------------|-----------------------|-----------------------------|-----------------|----------------|----------------------|----------|---------------|
|   |             |                |               |                       |                             |                 |                | Measured             | Reported |               |
| measured / reported SAR numbers - Body (distance 0mm) |             |                |               |                       |                             |                 |                |                      |          |               |
| 42  | 5210        | 802.11ac VHT80 | Rear          | 13.31                 | 13.50                       | 0.02            | 1.045          | 0.222                | 0.232    | Plot 2        |
| 42  | 5210        | 802.11ac VHT80 | Top           | 13.31                 | 13.50                       | -4.78           | 1.045          | 0.215                | 0.225    |               |

##### SAR Values [5.8G]

| Ch.   | Freq. (MHz) | Service | Test Position | Conducted Power (dBm) | Maximum Allowed Power (dBm) | Power Drift (%) | Scaling Factor | SAR1-g results(W/kg) |          | Graph Results |
|---|-------------|---------|---------------|-----------------------|-----------------------------|-----------------|----------------|----------------------|----------|---------------|
|   |             |         |               |                       |                             |                 |                | Measured             | Reported |               |
| measured / reported SAR numbers - Body (distance 0mm) |             |         |               |                       |                             |                 |                |                      |          |               |
| 149   | 5745        | 802.11a | Rear          | 13.32                 | 13.50                       | -1.46           | 1.042          | 0.181                | 0.189    | Plot 3        |
| 149   | 5745        | 802.11a | Top           | 13.32                 | 13.50                       | -2.56           | 1.042          | 0.168                | 0.175    |               |

Remark:

- The value with blue color is the maximum SAR Value of each test band.
- Per FCC KDB Publication 447498 D01, if the reported (scaled) SAR measured at the middle channel or highest output power channel for each test configuration is  $\leq 0.8$  W/kg then testing at the other channels is optional for such test configuration(s).
- SAR is required for the following 2.4 GHz OFDM conditions as the highest reported SAR for DSSS is adjusted by the ratio of OFDM to DSSS specified maximum output power and the adjusted SAR is  $0.187[0.262 * (10.00/14.00)] \leq 1.2$  W/kg.



Shenzhen LCS Compliance Testing Laboratory Ltd.

Add: 101, 201 Bldg A & 301 Bldg C, Juji Industrial Park Yabianxueziwei, Shajing Street, Baoan District, Shenzhen, 518000, China

Tel: +(86) 0755-82591330 | E-mail: webmaster@lcs-cert.com | Web: www.lcs-cert.com

Scan code to check authenticity



### 4.4.2 Standalone SAR Test Exclusion Considerations and Estimated SAR

Per KDB447498 requires when the standalone SAR test exclusion of section 4.3.1 is applied to an antenna that transmits simultaneously with other antennas, the standalone SAR must be estimated according to the following to determine simultaneous transmission SAR test exclusion;

• (max. power of channel, including tune-up tolerance, mW)/(min. test separation distance, mm) • [ √ f(GHz)/x] W/kg for test separation distances ≤ 50 mm;  
where x = 7.5 for 1-g SAR, and x = 18.75 for 10-g SAR.

• 0.4 W/kg for 1-g SAR and 1.0 W/kg for 10-g SAR, when the test separation distances is > 50 mm  
Per FCC KD B447498 D01, simultaneous transmission SAR test exclusion may be applied when the sum of the 1-g SAR for all the transmitting antenna in a specific a physical test configuration is ≤1.6 W/Kg. When the sum is greater than the SAR limit, SAR test exclusion is determined by the SAR to peak location separation ratio.

$$\text{Ratio} = \frac{(SAR_1 + SAR_2)^{1.5}}{(\text{peak location separation, mm})} < 0.04$$

| Estimated stand alone SAR |                 |               |                     |                          |                                     |
|---------------------------|-----------------|---------------|---------------------|--------------------------|-------------------------------------|
| Communication system      | Frequency (MHz) | Configuration | Maximum Power (dBm) | Separation Distance (mm) | Estimated SAR <sub>1-g</sub> (W/kg) |
| Bluetooth*                | 2450            | Body-worn     | 4.0                 | 5                        | 0.105                               |

Remark:

1. Bluetooth\*- Including Lower power Bluetooth
2. Maximum average power including tune-up tolerance;
3. When the minimum test separation distance is < 5 mm, a distance of 5 mm is applied to determine SAR test exclusion
4. Body as body use distance is 0mm from manufacturer declaration of user manual





### 4.5. SAR Measurement Variability

According to KDB865664, Repeated measurements are required only when the measured SAR is  $\geq 0.80$  W/kg. If the measured SAR value of the initial repeated measurement is  $< 1.45$  W/kg with  $\leq 20\%$  variation, only one repeated measurement is required to reaffirm that the results are not expected to have substantial variations, which may introduce significant compliance concerns. A second repeated measurement is required only if the measured result for the initial repeated measurement is within 10% of the SAR limit and vary by more than 20%, which are often related to device and measurement setup difficulties. The following procedures are applied to determine if repeated measurements are required. The same procedures should be adapted for measurements according to extremity and occupational exposure limits by applying a factor of 2.5 for extremity exposure and a factor of 5 for occupational exposure to the corresponding SAR thresholds.<sup>19</sup> The repeated measurement results must be clearly identified in the SAR report. All measured SAR, including the repeated results, must be considered to determine compliance and for reporting according to KDB 690783. Repeated measurement is not required when the original highest measured SAR is  $< 0.80$  W/kg; steps 2) through 4) do not apply.

- 1) When the original highest measured SAR is  $\geq 0.80$  W/kg, repeat that measurement once.
- 2) Perform a second repeated measurement only if the ratio of largest to smallest SAR for the original and first repeated measurements is  $> 1.20$  or when the original or repeated measurement is  $\geq 1.45$  W/kg ( $\sim 10\%$  from the 1-g SAR limit).
- 3) Perform a third repeated measurement only if the original, first or second repeated measurement is  $\geq 1.5$  W/kg and the ratio of largest to smallest SAR for the original, first and second repeated measurements is  $> 1.20$ .
- 4) Perform a third repeated measurement only if the original, first or second repeated measurement is  $\geq 1.5$  W/kg and the ratio of largest to smallest SAR for the original, first and second repeated measurements is  $> 1.20$ .

| Frequency Band (MHz) | Air Interface | RF Exposure Configuration | Test Position | Repeated SAR (yes/no) | Highest Measured SAR <sub>1-g</sub> (W/Kg) | First Repeated                     |                               |
|----------------------|---------------|---------------------------|---------------|-----------------------|--|------------------------------------|-------------------------------|
|                      |               |                           |               |                       |  | Measured SAR <sub>1-g</sub> (W/Kg) | Largest to Smallest SAR Ratio |
| 2450                 | 2.4GWLAN      | Standalone                | Body-Rear     | no                    | 0.275                                      | n/a                                | n/a                           |
| 5200                 | 5.2GWLAN      | Standalone                | Body-Rear     | no                    | 0.222                                      | n/a                                | n/a                           |
| 5800                 | 5.8GWLAN      | Standalone                | Body-Rear     | no                    | 0.181                                      | n/a                                | n/a                           |

Remark:

1. Second Repeated Measurement is not required since the ratio of the largest to smallest SAR for the original and first repeated measurement is not  $> 1.20$  or  $3$  (1-g or 10-g respectively)







#### 4.6. General description of test procedures

1. The DUT is tested using CMU 200 communications testers as controller unit to set test channels and maximum output power to the DUT, as well as for measuring the conducted peak power.
2. Test positions as described in the tables above are in accordance with the specified test standard.
3. Tests in body position were performed in that configuration, which generates the highest time based averaged output power (see conducted power results).
4. Tests in head position with GSM were performed in voice mode with 1 timeslot unless GPRS/EGPRS/DTM function allows parallel voice and data traffic on 2 or more timeslots.
5. UMTS was tested in RMC mode with 12.2 kbit/s and TPC bits set to 'all 1'.
6. WiFi was tested in 802.11b/g/n mode with 1 Mbit/s and 6 Mbit/s. According to KDB 248227 the SAR testing for 802.11g/n is not required since When the highest reported SAR for DSSS is adjusted by the ratio of OFDM to DSSS specified maximum output power and the adjusted SAR is  $\leq 1.2$  W/kg.
7. Required WiFi test channels were selected according to KDB 248227
8. According to FCC KDB pub 248227 D01, When there are multiple test channels with the same measured maximum output power, the channel closest to mid-band frequency is selected for SAR measurement and when there are multiple test channels with the same measured maximum output power and equal separation from mid-band frequency; for example, high and low channels or two mid-band channels, the higher frequency (number) channel is selected for SAR measurement.
9. According to FCC KDB pub 941225 D06 this device has been tested with 10 mm distance to the phantom for operation in WiFi hot spot mode.
10. Per FCC KDB pub 941225 D06 the edges with antennas within 2.5 cm are required to be evaluated for SAR to cover WiFi hot spot function.
11. According to IEEE 1528 the SAR test shall be performed at middle channel. Testing of top and bottom channel is optional.
12. According to KDB 447498 D01 testing of other required channels within the operating mode of a frequency band is not required when the reported 1-g or 10-g SAR for the mid-band or highest output power channel is:
  - $\leq 0.8$  W/kg or 2.0 W/kg, for 1-g or 10-g respectively, when the transmission band is  $\leq 100$  MHz
  - $\leq 0.6$  W/kg or 1.5 W/kg, for 1-g or 10-g respectively, when the transmission band is between 100 MHz and 200 MHz
  - $\leq 0.4$  W/kg or 1.0 W/kg, for 1-g or 10-g respectively, when the transmission band is  $\geq 200$  MHz
13. IEEE 1528-2003 require the middle channel to be tested first. This generally applies to wireless devices that are designed to operate in technologies with tight tolerances for maximum output power variations across channels in the band.
14. Per KDB648474 D04 require when the reported SAR for a body-worn accessory, measured without a headset connected to the handset, is  $< 1.2$  W/kg.
15. Per KDB648474 D04 require when the separation distance required for body-worn accessory testing is larger than or equal to that tested for hotspot mode, using the same wireless mode test configuration for voice and data, such as UMTS and Wi-Fi, and for the same surface of the phone, the hotspot mode SAR data may be used to support body-worn accessory SAR compliance for that particular configuration (surface)
16. 10-g extremity SAR is required only for the surfaces and edges with hotspot mode 1-g SAR  $> 1.2$  W/kg.
17. Per KDB648474 D04 require for phablet SAR test considerations. For Mobile Phones with a display diagonal dimension  $> 15.0$  cm or an overall diagonal dimension  $> 16.0$  cm, When hotspot mode applies, 10-g extremity SAR is required only for the surfaces and edges with hotspot mode 1-g reported SAR  $> 1.2$  W/kg.
18. 10-g extremity SAR is required only for the surfaces and edges with hotspot mode 1-g SAR  $> 1.2$  W/kg.

#### 4.7. Measurement Uncertainty (450MHz-6GHz)

Not required as SAR measurement uncertainty analysis is required in SAR reports only when the highest measured SAR in a frequency band is  $\geq 1.5$  W/kg for 1-g SAR according to KDB865664D01.



### 4.8. System Check Results

Test mode:2450MHz(Head)  
 Product Description:Validation  
 Model:Dipole SID2450  
 E-Field Probe:SSE2(SN 25/22 EPGO376)  
 Test Date: July 14, 2023

|                                   |           |
|-----------------------------------|-----------|
| Medium(liquid type)               | HSL_2450  |
| Frequency (MHz)                   | 2450.0000 |
| Relative permittivity (real part) | 39.52     |
| Conductivity (S/m)                | 1.78      |
| Input power                       | 100mW     |
| Crest Factor                      | 1.0       |
| Conversion Factor                 | 2.60      |
| Variation (%)                     | 3.260000  |
| SAR 10g (W/Kg)                    | 2.505463  |
| SAR 1g (W/Kg)                     | 5.435016  |

#### SURFACE SAR

#### VOLUME SAR

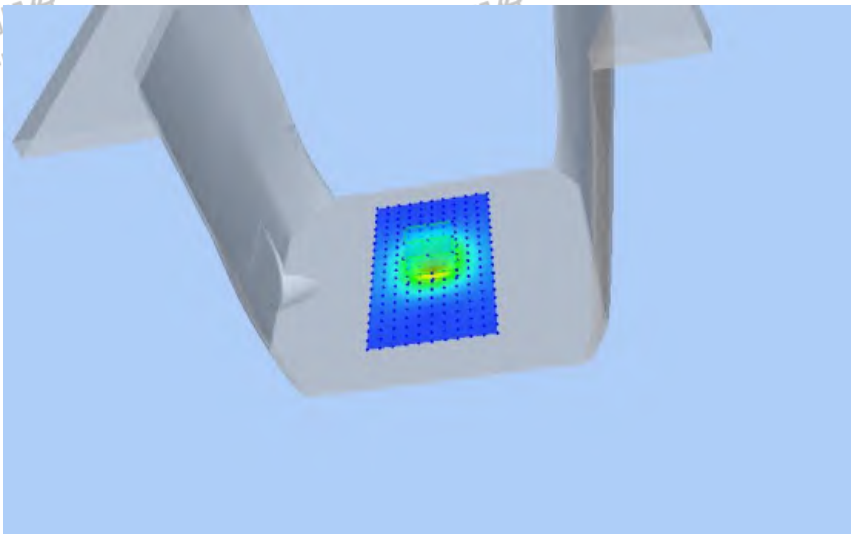
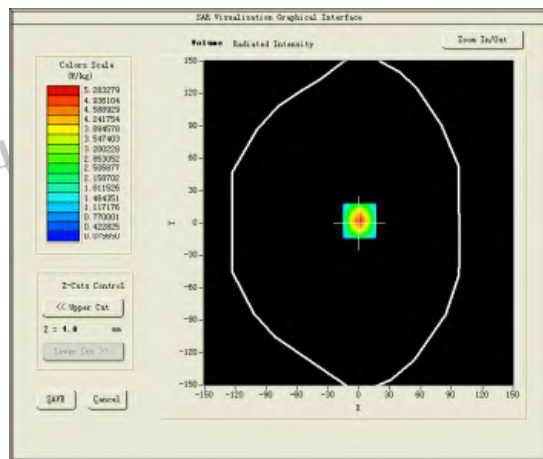
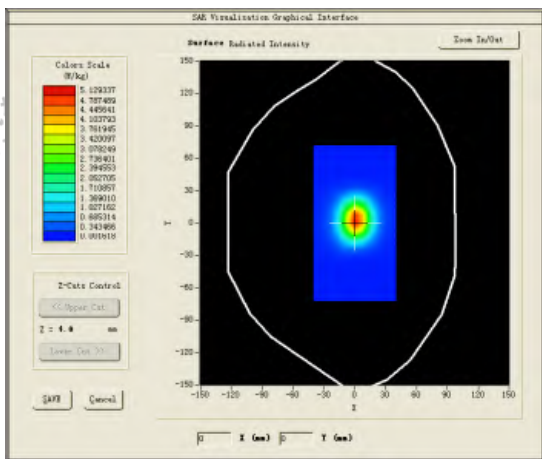

Test mode:5200MHz(Head)  
 Product Description:Validation  
 Model:Dipole SID5000  
 E-Field Probe: SSE2(SN 25/22 EPGO376)  
 Test Date: July 18, 2023

|                                   |           |
|-----------------------------------|-----------|
| Medium(liquid type)               | HSL_5000  |
| Frequency (MHz)                   | 5200.0000 |
| Relative permittivity (real part) | 35.54     |
| Conductivity (S/m)                | 4.68      |
| Input power                       | 100mW     |
| Crest Factor                      | 1.0       |
| Conversion Factor                 | 1.85      |
| Variation (%)                     | -1.140000 |
| SAR 10g (W/Kg)                    | 5.565210  |
| SAR 1g (W/Kg)                     | 15.598034 |

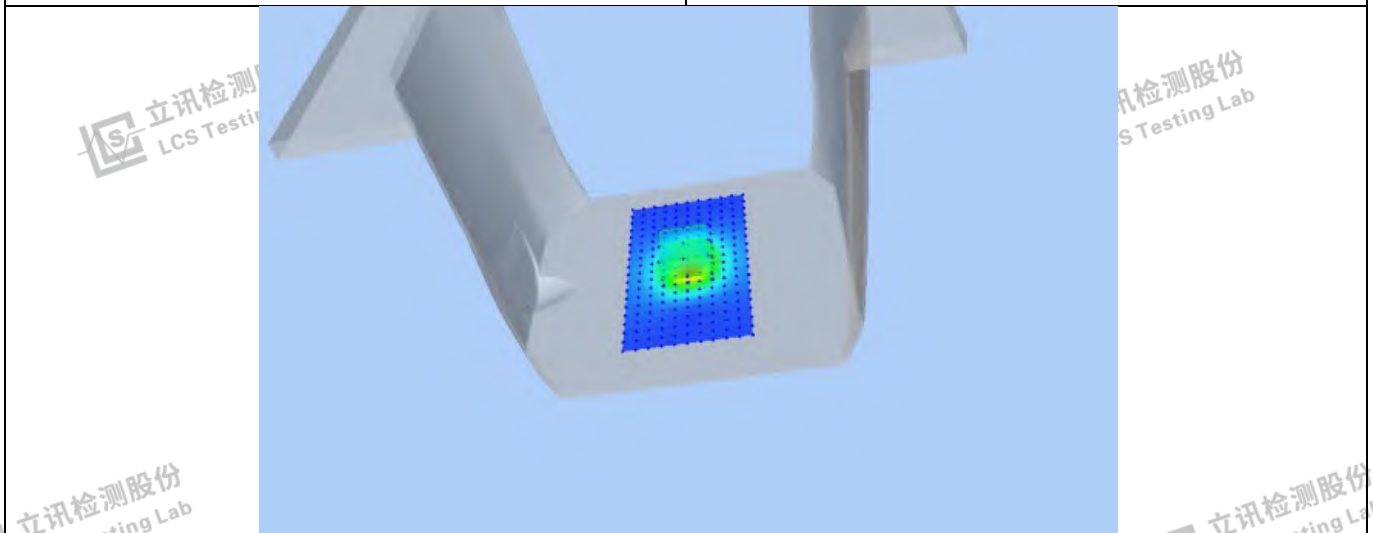
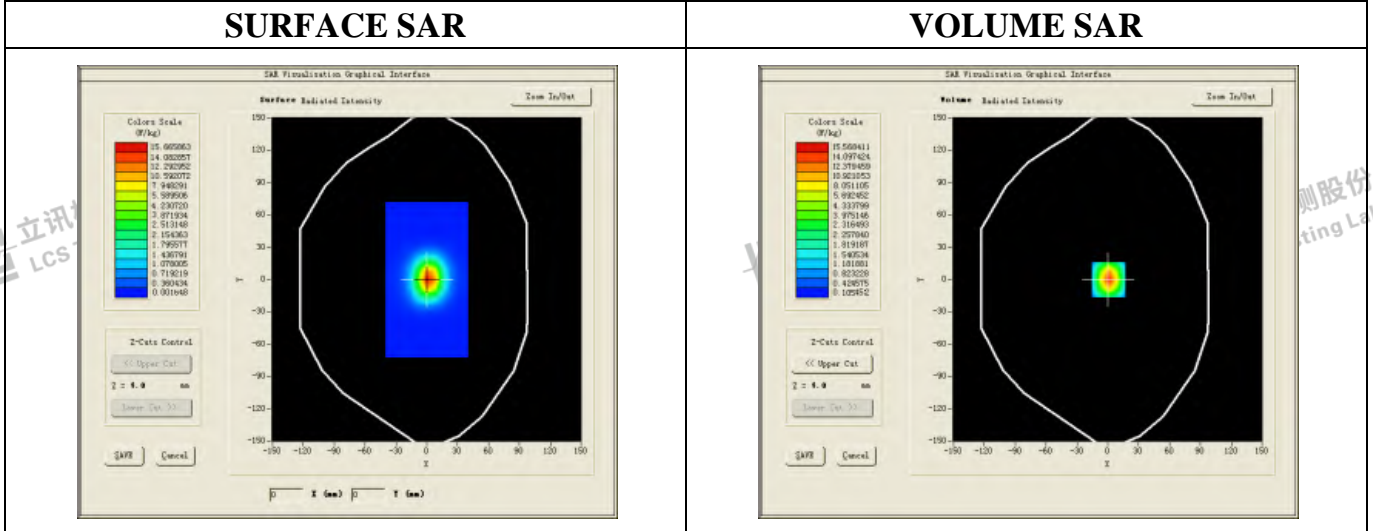

Test mode:5800MHz(Head)  
 Product Description:Validation  
 Model:Dipole SID5000  
 E-Field Probe: SSE2(SN 25/22 EPGO376)  
 Test Date: July 24, 2023

|                                   |           |
|-----------------------------------|-----------|
| Medium(liquid type)               | HSL_5000  |
| Frequency (MHz)                   | 5800.0000 |
| Relative permittivity (real part) | 35.10     |
| Conductivity (S/m)                | 5.29      |
| Input power                       | 100mW     |
| Crest Factor                      | 1.0       |
| Conversion Factor                 | 2.01      |
| Variation (%)                     | -3.320000 |
| SAR 10g (W/Kg)                    | 6.190085  |
| SAR 1g (W/Kg)                     | 18.277125 |

|                    |                   |
|--------------------|-------------------|
| <b>SURFACE SAR</b> | <b>VOLUME SAR</b> |
|--------------------|-------------------|

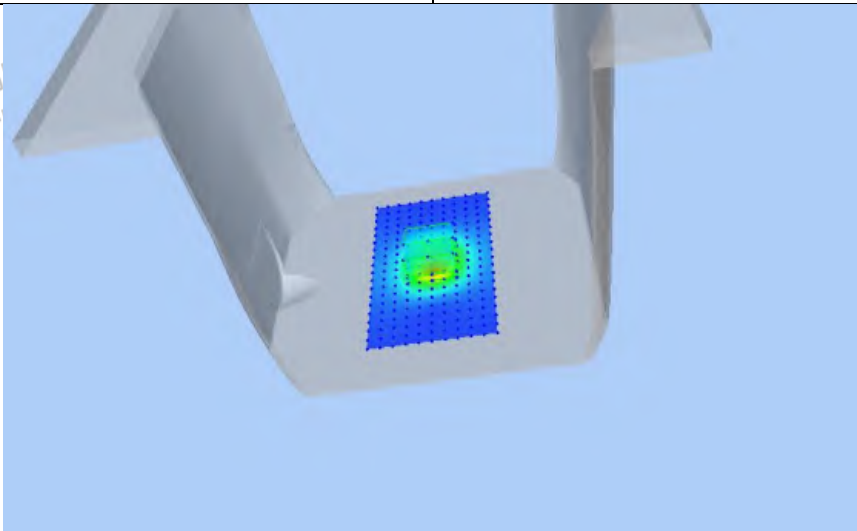
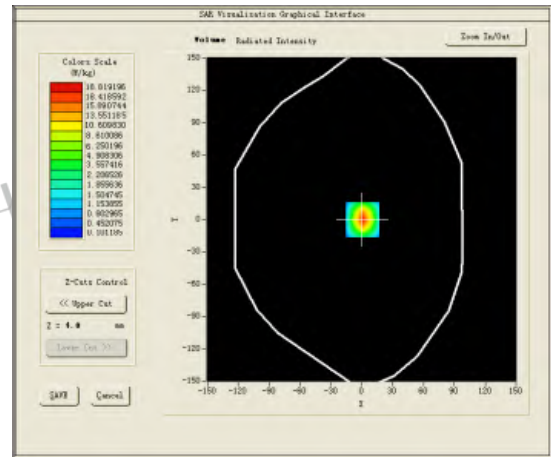
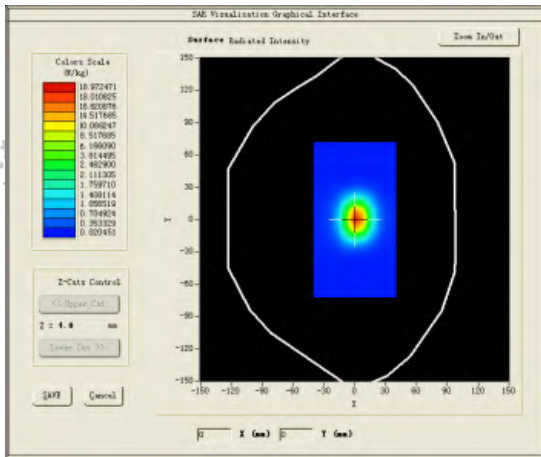



### 4.8 SAR Test Graph Results

SAR plots for the highest measured SAR in each exposure configuration, wireless mode and frequency band combination according to FCC KDB 865664 D02.

#1

Test Mode: 802.11b (WiFi2.4G),Low channel(Body Rear Side)

Product Description:DT20

Model:HPPAP21

Test Date: July 14, 2023

|                                   |                            |
|-----------------------------------|----------------------------|
| Medium(liquid type)               | HSL_2450                   |
| Frequency (MHz)                   | 2412.0000                  |
| Relative permittivity (real part) | 39.40                      |
| Conductivity (S/m)                | 1.79                       |
| E-Field Probe                     | SN 25/22 EPGO376           |
| Crest Factor                      | 1.0                        |
| Conversion Factor                 | 2.60                       |
| Sensor                            | 4mm                        |
| Area Scan                         | dx=8mm dy=8mm              |
| Zoom Scan                         | 5x5x7,dx=8mm dy=8mm dz=5mm |
| Variation (%)                     | 2.240000                   |
| SAR 10g (W/Kg)                    | 0.163036                   |
| SAR 1g (W/Kg)                     | 0.274708                   |
| <b>SURFACE SAR</b>                | <b>VOLUME SAR</b>          |

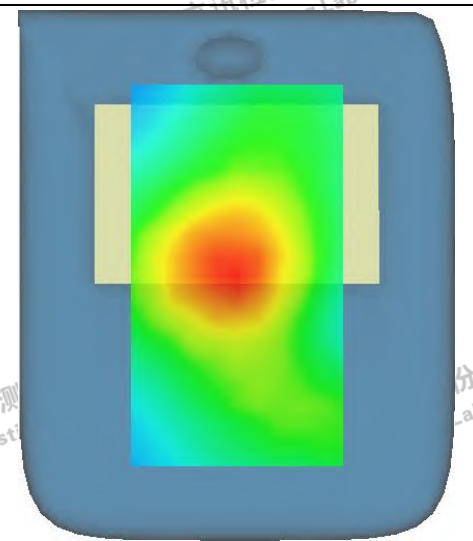
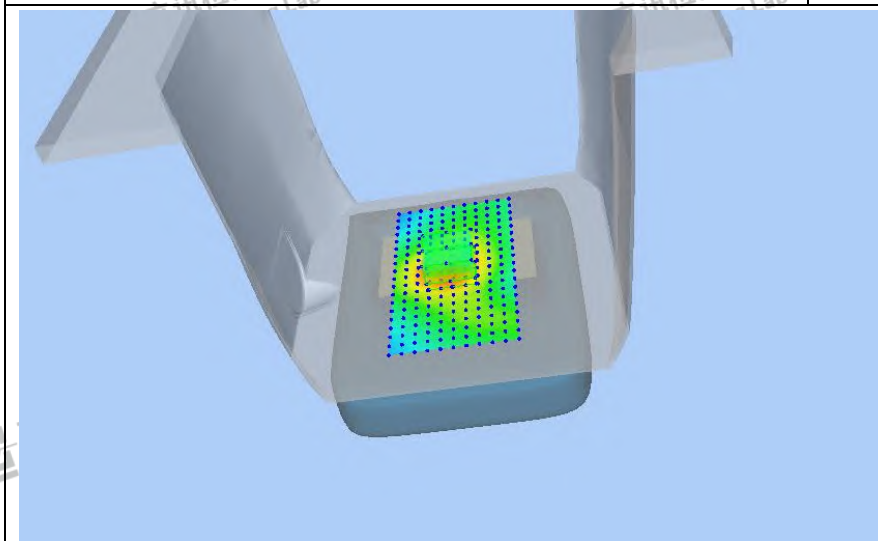
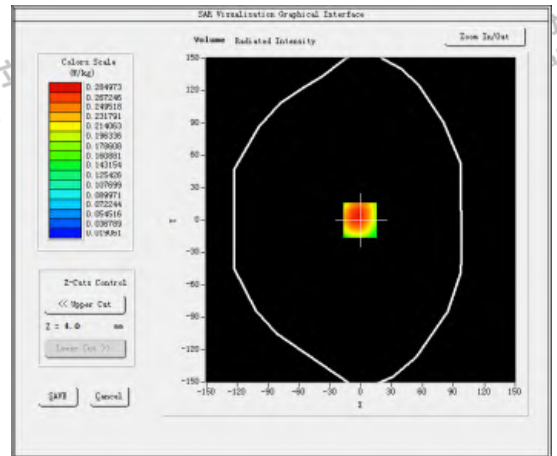
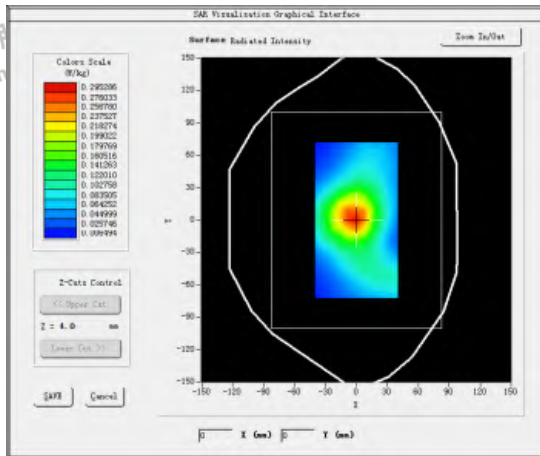

#2

Test Mode: 802.11ac VHT80 (WiFi5.2G),High channel(Body Rear Side)

Product Description:DT20

Model:HPPAP21

Test Date: July 18, 2023

|                                   |                              |
|-----------------------------------|------------------------------|
| Medium(liquid type)               | HSL_5000                     |
| Frequency (MHz)                   | 5210.0000                    |
| Relative permittivity (real part) | 35.77                        |
| Conductivity (S/m)                | 4.66                         |
| E-Field Probe                     | SN 25/22 EPGO376             |
| Crest Factor                      | 1.0                          |
| Conversion Factor                 | 1.85                         |
| Sensor                            | 4mm                          |
| Area Scan                         | dx=10mm dy=10mm              |
| Zoom Scan                         | 7x7x7,dx=4mm dy=4mm dz=1.4mm |
| Variation (%)                     | 0.020000                     |
| SAR 10g (W/Kg)                    | 0.095447                     |
| SAR 1g (W/Kg)                     | 0.222382                     |

**SURFACE SAR**

**VOLUME SAR**

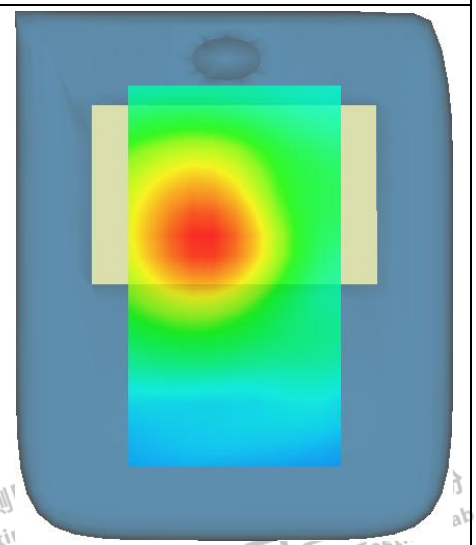
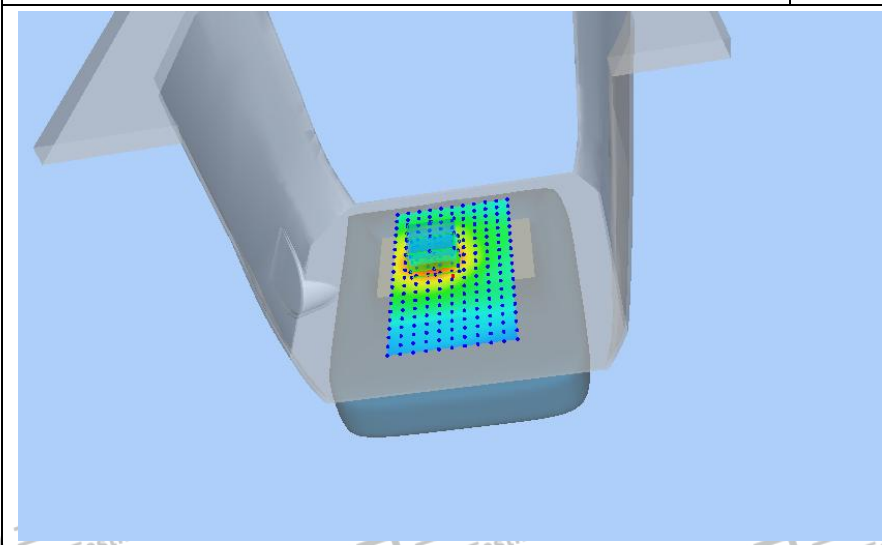
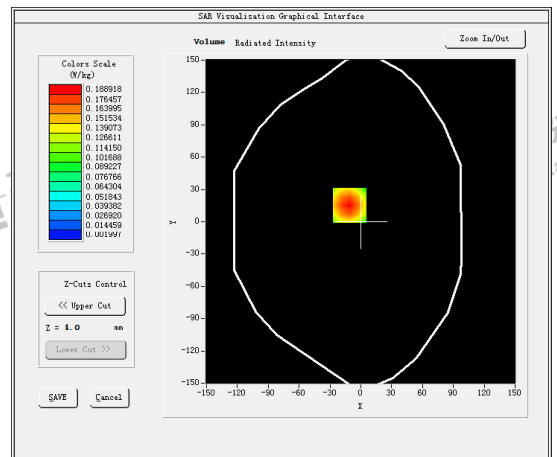
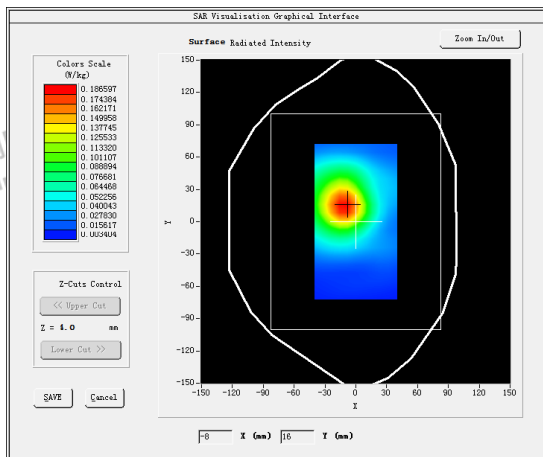

#3

Test Mode: 802.11a (WiFi5.8G),Low channel(Body Rear Side)

Product Description:DT20

Model:HPPAP21

Test Date: July 24, 2023

|                                   |                              |
|-----------------------------------|------------------------------|
| Medium(liquid type)               | HSL_5000                     |
| Frequency (MHz)                   | 5745.0000                    |
| Relative permittivity (real part) | 35.01                        |
| Conductivity (S/m)                | 5.30                         |
| E-Field Probe                     | SN 25/22 EPGO376             |
| Crest Factor                      | 1.0                          |
| Conversion Factor                 | 2.01                         |
| Sensor                            | 4mm                          |
| Area Scan                         | dx=10mm dy=10mm              |
| Zoom Scan                         | 7x7x7,dx=4mm dy=4mm dz=1.4mm |
| Variation (%)                     | -1.460000                    |
| SAR 10g (W/Kg)                    | 0.115528                     |
| SAR 1g (W/Kg)                     | 0.181448                     |

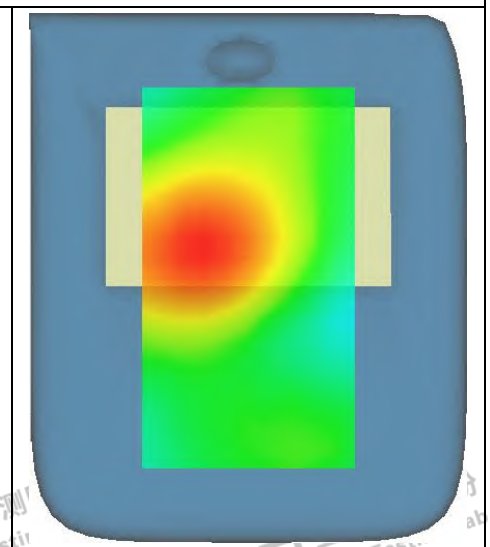
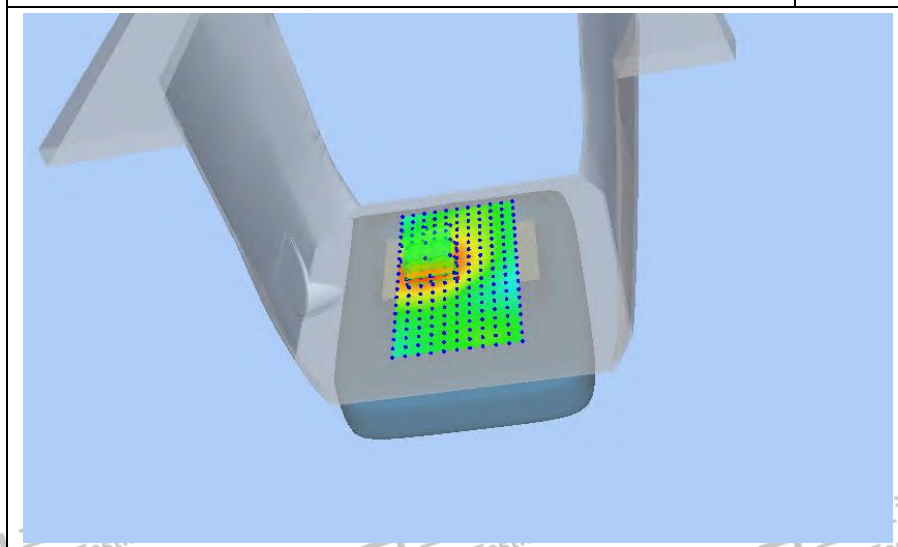
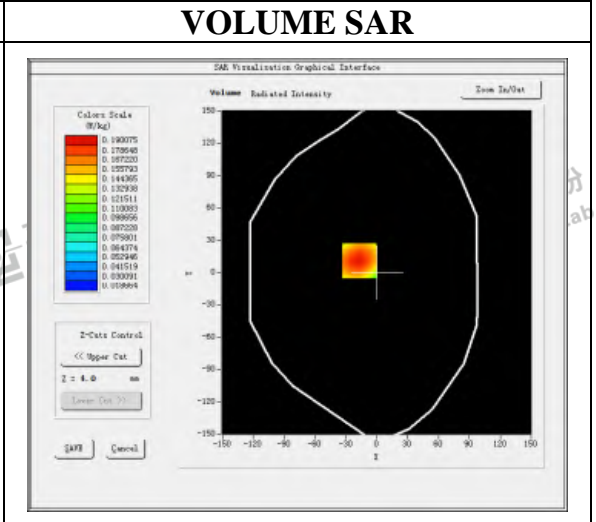
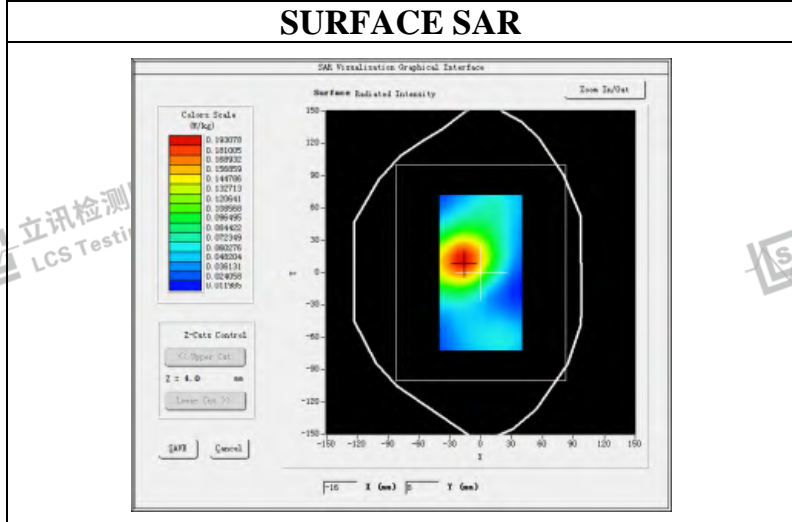



## 5. CALIBRATION CERTIFICATES

### 5.1 Probe-EPGO376 Calibration Certificate



## COMOSAR E-Field Probe Calibration Report

Ref : ACR.180.4.42.BES.A

### SHENZHEN LCS COMPLIANCE TESTING LABORATORY LTD.

1F., XINGYUAN INDUSTRIAL PARK, TONGDA ROAD, BAO'AN BLVD

BAO'AN DISTRICT, SHENZHEN, GUANGDONG, CHINA

MVG COMOSAR DOSIMETRIC E-FIELD PROBE

SERIAL NO.: SN 25/22 EPGO376

#### Calibrated at MVG

Z.I. de la pointe du diable

Technopôle Brest Iroise – 295 avenue Alexis de Rochon

29280 PLOUZANE - FRANCE

Calibration date: 06/22/2023



Accreditations #2-6792  
Scope available on [www.cofrac.fr](http://www.cofrac.fr)

The use of the Cofrac brand and the accreditation references is prohibited from any reproduction.

#### Summary:

This document presents the method and results from an accredited COMOSAR Dosimetric E-Field Probe calibration performed at MVG, using the CALIPROBE test bench, for use with a MVG COMOSAR system only. The test results covered by accreditation are traceable to the International System of Units (SI).







COMOSAR E-FIELD PROBE CALIBRATION REPORT

Ref: ACR.180.4.42.BES.A

份  
Lab

|                                   | <i>Name</i>    | <i>Function</i>         | <i>Date</i> | <i>Signature</i> |
|-----------------------------------|----------------|-------------------------|-------------|------------------|
| <i>Prepared by :</i>              | Jérôme Le Gall | Measurement Responsible | 6/23/2023   |                  |
| <i>Checked &amp; approved by:</i> | Jérôme Luc     | Technical Manager       | 6/23/2023   |                  |
| <i>Authorized by:</i>             | Yann Toutain   | Laboratory Director     | 6/23/2023   |                  |

2023.06.23

13:37:50 +02'03'

|                       | <i>Customer Name</i>                            |
|-----------------------|---|
| <i>Distribution :</i> | Shenzhen LCS Compliance Testing Laboratory Ltd. |

份  
Lab

| <i>Issue</i> | <i>Name</i>    | <i>Date</i> | <i>Modifications</i> |
|--------------|----------------|-------------|----------------------|
| A            | Jérôme Le Gall | 6/23/2023   | Initial release      |
|              |                |             |                      |
|              |                |             |                      |
|              |                |             |                      |

Template\_ACR.DDD.N.VV.MVGB.ISSUE\_COMOSAR Probe vK

This document shall not be reproduced, except in full or in part, without the written approval of MVG. The information contained herein is to be used only for the purpose for which it is submitted and is not to be released in whole or part without written approval of MVG.

份  
Lab





COMOSAR E-FIELD PROBE CALIBRATION REPORT

Ref: ACR.180.442.BES.A

份  
Lab

TABLE OF CONTENTS

1 Device Under Test ..... 4

2 Product Description ..... 4

    2.1 General Information ..... 4

3 Measurement Method ..... 4

    3.1 Linearity ..... 4

    3.2 Sensitivity ..... 4

    3.3 Lower Detection Limit ..... 5

    3.4 Isotropy ..... 5

    3.1 Boundary Effect ..... 5

4 Measurement Uncertainty ..... 6

5 Calibration Measurement Results ..... 6

    5.1 Sensitivity in air ..... 6

    5.2 Linearity ..... 7

    5.3 Sensitivity in liquid ..... 8

    5.4 Isotropy ..... 9

6 List of Equipment ..... 10

份  
Lab

Template\_ACR.DDD.N.YY.MVGB.ISSUE\_COMOSAR Probe vK

This document shall not be reproduced, except in full or in part, without the written approval of MVG. The information contained herein is to be used only for the purpose for which it is submitted and is not to be released in whole or part without written approval of MVG.

份  
Lab





COMOSAR E-FIELD PROBE CALIBRATION REPORT

Ref: ACR.180.4.42.BES.A

**1 DEVICE UNDER TEST**

| Device Under Test                        |   |
|--|---|
| Device Type                              | COMOSAR DOSIMETRIC E FIELD PROBE  |
| Manufacturer                             | MVG   |
| Model                                    | SSE2  |
| Serial Number                            | SN 25/22 EPGO376  |
| Product Condition (new / used)           | New   |
| Frequency Range of Probe                 | 0.15 GHz-6GHz   |
| Resistance of Three Dipoles at Connector | Dipole 1: R1=0.193 MΩ<br>Dipole 2: R2=0.188 MΩ<br>Dipole 3: R3=0.198 MΩ |

**2 PRODUCT DESCRIPTION**

**2.1 GENERAL INFORMATION**

MVG's COMOSAR E field Probes are built in accordance to the IEC/IEEE 62209-1528 and FCC KDB865664 D01 standards.



Figure 1 – MVG COMOSAR Dosimetric E field Probe

|  |        |
|--|--------|
| Probe Length                               | 330 mm |
| Length of Individual Dipoles               | 2 mm   |
| Maximum external diameter                  | 8 mm   |
| Probe Tip External Diameter                | 2.5 mm |
| Distance between dipoles / probe extremity | 1 mm   |

**3 MEASUREMENT METHOD**

The IEC/IEEE 62209-1528 and FCC KDB865664 D01 standards provide recommended practices for the probe calibrations, including the performance characteristics of interest and methods by which to assess their affect. All calibrations / measurements performed meet the fore mentioned standards.

**3.1 LINEARITY**

The evaluation of the linearity was done in free space using the waveguide, performing a power sweep to cover the SAR range 0.01W/kg to 100W/kg.

**3.2 SENSITIVITY**

The sensitivity factors of the three dipoles were determined using a two step calibration method (air and tissue simulating liquid) using waveguides as outlined in the standards.

Page: 4/11

Template\_ACR.DDD.N.YY.MVGB.ISSUE\_COMOSAR Probe vK

This document shall not be reproduced, except in full or in part, without the written approval of MVG. The information contained herein is to be used only for the purpose for which it is submitted and is not to be released in whole or part without written approval of MVG.







### 3.3 LOWER DETECTION LIMIT

The lower detection limit was assessed using the same measurement set up as used for the linearity measurement. The required lower detection limit is 10 mW/kg.

### 3.4 ISOTROPY

The axial isotropy was evaluated by exposing the probe to a reference wave from a standard dipole with the dipole mounted under the flat phantom in the test configuration suggested for system validations and checks. The probe was rotated along its main axis from 0 to 360 degrees in 15-degree steps. The hemispherical isotropy is determined by inserting the probe in a thin plastic box filled with tissue-equivalent liquid, with the plastic box illuminated with the fields from a half wave dipole. The dipole is rotated about its axis (0°–180°) in 15° increments. At each step the probe is rotated about its axis (0°–360°).

### 3.1 BOUNDARY EFFECT

The boundary effect is defined as the deviation between the SAR measured data and the expected exponential decay in the liquid when the probe is oriented normal to the interface. To evaluate this effect, the liquid filled flat phantom is exposed to fields from either a reference dipole or waveguide. With the probe normal to the phantom surface, the peak spatial average SAR is measured and compared to the analytical value at the surface.

The boundary effect uncertainty can be estimated according to the following uncertainty approximation formula based on linear and exponential extrapolations between the surface and  $d_{be} + d_{step}$  along lines that are approximately normal to the surface:

$$SAR_{uncertainty} [\%] = \Delta SAR_{be} \frac{(d_{be} + d_{step})^2}{2d_{step}} \frac{(e^{-d_{be}/\delta/2})}{\delta/2} \text{ for } (d_{be} + d_{step}) < 10 \text{ mm}$$

where

|                     |  |
|---------------------|--|
| $SAR_{uncertainty}$ | is the uncertainty in percent of the probe boundary effect   |
| $d_{be}$            | is the distance between the surface and the closest <i>zoom-scan</i> measurement point, in millimetre  |
| $\Delta_{step}$     | is the separation distance between the first and second measurement points that are closest to the phantom surface, in millimetre, assuming the boundary effect at the second location is negligible |
| $\delta$            | is the minimum penetration depth in millimetres of the head tissue-equivalent liquids defined in this standard, i.e., $\delta \approx 14$ mm at 3 GHz;   |
| $\Delta SAR_{be}$   | in percent of SAR is the deviation between the measured SAR value, at the distance $d_{be}$ from the boundary, and the analytical SAR value.   |

The measured worst case boundary effect SAR uncertainty[%] for scanning distances larger than 4mm is 1.0% Limit ,2%).







## COMOSAR E-FIELD PROBE CALIBRATION REPORT

Ref: ACR.180.4.42.BES.A

**4 MEASUREMENT UNCERTAINTY**

The guidelines outlined in the IEC/IEEE 62209-1528 and FCC KDB865664 D01 standards were followed to generate the measurement uncertainty associated with an E-field probe calibration using the waveguide technique. All uncertainties listed below represent an expanded uncertainty expressed at approximately the 95% confidence level using a coverage factor of  $k=2$ , traceable to the Internationally Accepted Guides to Measurement Uncertainty.

| Uncertainty analysis of the probe calibration in waveguide |                       |                          |         |    |                          |
|--|-----------------------|--------------------------|---------|----|--------------------------|
| ERROR SOURCES  | Uncertainty value (%) | Probability Distribution | Divisor | ci | Standard Uncertainty (%) |
| Expanded uncertainty<br>95 % confidence level $k = 2$      |                       |                          |         |    | 14 %                     |

**5 CALIBRATION MEASUREMENT RESULTS**

| Calibration Parameters |             |
|------------------------|-------------|
| Liquid Temperature     | 20 +/- 1 °C |
| Lab Temperature        | 20 +/- 1 °C |
| Lab Humidity           | 30-70 %     |

**5.1 SENSITIVITY IN AIR**

| Normx dipole 1 ( $\mu\text{V}/(\text{V}/\text{m})^2$ ) | Normy dipole 2 ( $\mu\text{V}/(\text{V}/\text{m})^2$ ) | Normz dipole 3 ( $\mu\text{V}/(\text{V}/\text{m})^2$ ) |
|--|--|--|
| 0.76   | 0.78   | 0.76   |

| DCP dipole 1 (mV) | DCP dipole 2 (mV) | DCP dipole 3 (mV) |
|-------------------|-------------------|-------------------|
| 106               | 107               | 108               |

Calibration curves  $e_i=f(V)$  ( $i=1,2,3$ ) allow to obtain E-field value using the formula:

$$E = \sqrt{E_1^2 + E_2^2 + E_3^2}$$

Page: 6/11

Template\_ACR.DDD.N.YY.MVGB.ISSUE\_COMOSAR Probe vK

This document shall not be reproduced, except in full or in part, without the written approval of MVG. The information contained herein is to be used only for the purpose for which it is submitted and is not to be released in whole or part without written approval of MVG.





COMOSAR E-FIELD PROBE CALIBRATION REPORT

Ref: ACR.180.4.42.BES.A

份  
Lab

Calibration curves

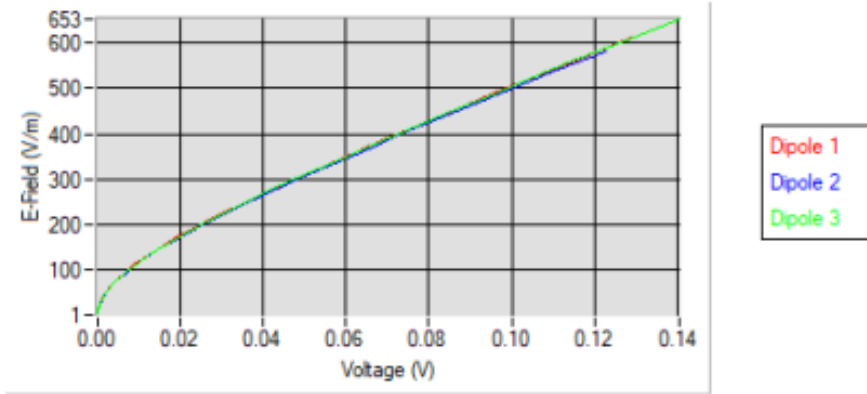

5.2 LINEARITY

Linearity

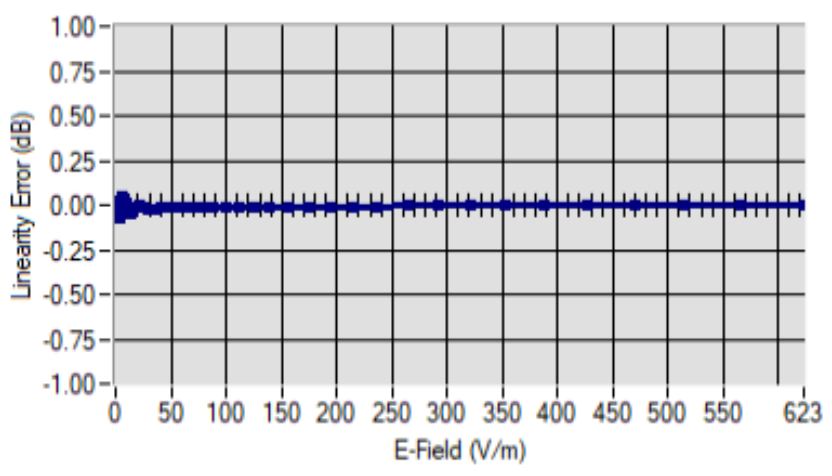

Linearity:  $\pm 1.81\%$  ( $\pm 0.08\text{dB}$ )

Template\_ACR.DDD.N.YY.MVGB.ISSUE\_COMOSAR Probe vK

This document shall not be reproduced, except in full or in part, without the written approval of MVG. The information contained herein is to be used only for the purpose for which it is submitted and is not to be released in whole or part without written approval of MVG.



份  
Lab





COMOSAR E-FIELD PROBE CALIBRATION REPORT

Ref: ACR.180.4.42.BES.A

股份  
ig Lab

5.3 SENSITIVITY IN LIQUID

| Liquid | Frequency<br>(MHz +/-<br>100MHz) | ConvF |
|--------|----------------------------------|-------|
| HL450* | 450*                             | 1.74* |
| BL450* | 450*                             | 1.67* |
| HL750  | 750                              | 1.69  |
| BL750  | 750                              | 1.73  |
| HL850  | 835                              | 1.75  |
| BL850  | 835                              | 1.80  |
| HL900  | 900                              | 1.87  |
| BL900  | 900                              | 1.85  |
| HL1800 | 1800                             | 2.09  |
| BL1800 | 1800                             | 2.15  |
| HL1900 | 1900                             | 2.14  |
| BL1900 | 1900                             | 2.27  |
| HL2000 | 2000                             | 2.31  |
| BL2000 | 2000                             | 2.34  |
| HL2300 | 2300                             | 2.46  |
| BL2300 | 2300                             | 2.51  |
| HL2450 | 2450                             | 2.60  |
| BL2450 | 2450                             | 2.70  |
| HL2600 | 2600                             | 2.39  |
| BL2600 | 2600                             | 2.50  |
| HL5200 | 5200                             | 1.85  |
| BL5200 | 5200                             | 1.81  |
| HL5400 | 5400                             | 2.07  |
| BL5400 | 5400                             | 2.00  |
| HL5600 | 5600                             | 2.19  |
| BL5600 | 5600                             | 2.11  |
| HL5800 | 5800                             | 2.01  |
| BL5800 | 5800                             | 1.97  |

\* Frequency not cover by COFRAC scope, calibration not accredited

LOWER DETECTION LIMIT: 7mW/kg

Template\_ACR.DDD.N.YY.MVGB.ISSUE\_COMOSAR Probe vK

This document shall not be reproduced, except in full or in part, without the written approval of MVG. The information contained herein is to be used only for the purpose for which it is submitted and is not to be released in whole or part without written approval of MVG.

股份  
ig Lab





COMOSAR E-FIELD PROBE CALIBRATION REPORT

Ref: ACR.180.4.42.BES.A

股份  
ig Lab

5.4 ISOTROPY

HL1800 MHz

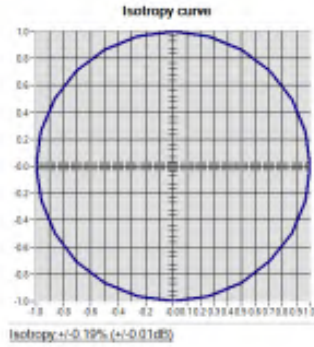

股份  
ig Lab

股份  
ig Lab







COMOSAR E-FIELD PROBE CALIBRATION REPORT

Ref: ACR.180.4.42.BES.A

股份  
ig Lab

6 LIST OF EQUIPMENT

| Equipment Summary Sheet            |                      |                         |   |   |
|------------------------------------|----------------------|-------------------------|---|---|
| Equipment Description              | Manufacturer / Model | Identification No.      | Current Calibration Date                      | Next Calibration Date                         |
| CALIPROBE Test Bench               | Version 2            | NA                      | Validated. No cal required.                   | Validated. No cal required.                   |
| Network Analyzer                   | Rohde & Schwarz ZVM  | 100203                  | 08/2021                                       | 08/2024                                       |
| Network Analyzer                   | Agilent 8753ES       | MY40003210              | 10/2022                                       | 10/2025                                       |
| Network Analyzer – Calibration kit | HP 85033D            | 3423A08186              | 06/2021                                       | 06/2027                                       |
| Multimeter                         | Keithley 2000        | 1160271                 | 02/2023                                       | 02/2026                                       |
| Signal Generator                   | Rohde & Schwarz SMB  | 106589                  | 03/2022                                       | 03/2025                                       |
| Amplifier                          | MVG                  | MODU-023-C-0002         | Characterized prior to test. No cal required. | Characterized prior to test. No cal required. |
| Power Meter                        | NI-USB 5680          | 170100013               | 06/2021                                       | 06/2024                                       |
| Power Meter                        | Rohde & Schwarz NRVD | 832839-056              | 11/2022                                       | 11/2025                                       |
| Directional Coupler                | Krytar 158020        | 131467                  | Characterized prior to test. No cal required. | Characterized prior to test. No cal required. |
| Waveguide                          | MVG                  | SN 32/16 WG4_1          | Validated. No cal required.                   | Validated. No cal required.                   |
| Liquid transition                  | MVG                  | SN 32/16 WGLIQ_0G900_1  | Validated. No cal required.                   | Validated. No cal required.                   |
| Waveguide                          | MVG                  | SN 32/16 WG6_1          | Validated. No cal required.                   | Validated. No cal required.                   |
| Liquid transition                  | MVG                  | SN 32/16 WGLIQ_1G500_1  | Validated. No cal required.                   | Validated. No cal required.                   |
| Waveguide                          | MVG                  | SN 32/16 WG8_1          | Validated. No cal required.                   | Validated. No cal required.                   |
| Liquid transition                  | MVG                  | SN 32/16 WGLIQ_1G800B_1 | Validated. No cal required.                   | Validated. No cal required.                   |
| Liquid transition                  | MVG                  | SN 32/16 WGLIQ_1G800H_1 | Validated. No cal required.                   | Validated. No cal required.                   |
| Waveguide                          | MVG                  | SN 32/16 WG10_1         | Validated. No cal required.                   | Validated. No cal required.                   |
| Liquid transition                  | MVG                  | SN 32/16 WGLIQ_3G500_1  | Validated. No cal required.                   | Validated. No cal required.                   |
| Waveguide                          | MVG                  | SN 32/16 WG12_1         | Validated. No cal required.                   | Validated. No cal required.                   |

Page: 10/11

Template\_ACR.DDD.N.YY.MVGB.ISSUE\_COMOSAR Probe vK

This document shall not be reproduced, except in full or in part, without the written approval of MVG. The information contained herein is to be used only for the purpose for which it is submitted and is not to be released in whole or part without written approval of MVG.

股份  
ig Lab

股份  
ig Lab





COMOSAR E-FIELD PROBE CALIBRATION REPORT

Ref: ACR.180.442.BES.A

股份  
ig Lab

|                                  |              |                           |                                |                                |
|----------------------------------|--------------|---------------------------|--------------------------------|--------------------------------|
| Liquid transition                | MVG          | SN 32/16<br>WGLIQ_5G000_1 | Validated. No cal<br>required. | Validated. No cal<br>required. |
| Temperature / Humidity<br>Sensor | Testo 184 H1 | 44225320                  | 06/2021                        | 06/2024                        |

股份  
ig Lab

Template\_ACR.DDD.N.YY.MVGB.ISSUE\_COMOSAR Probe vK

This document shall not be reproduced, except in full or in part, without the written approval of MVG. The information contained herein is to be used only for the purpose for which it is submitted and is not to be released in whole or part without written approval of MVG.

股份  
ig Lab





### 5.2 SID2450 Dipole Calibration Certificate



## SAR Reference Dipole Calibration Report

Ref : ACR.287.8.14.SATU.A

**SHENZHEN LCS COMPLIANCE TESTING  
LABORATORY LTD.**  
**1F., XINGYUAN INDUSTRIAL PARK, TONGDA ROAD,  
BAO'AN BLVD**  
**BAO'AN DISTRICT, SHENZHEN, GUANGDONG, CHINA**  
**SATIMO COMOSAR REFERENCE DIPOLE**  
**FREQUENCY: 2450 MHZ**  
**SERIAL NO.: SN 07/14 DIP 2G450-306**

**Calibrated at SATIMO US**  
**2105 Barrett Park Dr. - Kennesaw, GA 30144**



**09/29/2021**

*Summary:*

This document presents the method and results from an accredited SAR reference dipole calibration performed in SATIMO USA using the COMOSAR test bench. All calibration results are traceable to national metrology institutions.



股份  
ing Lab

股份  
ing Lab

股份  
ing Lab



SAR REFERENCE DIPOLE CALIBRATION REPORT

Ref: ACR.287.8.14.SATU.A

股份  
g Lab

|                      | <i>Name</i>   | <i>Function</i> | <i>Date</i> | <i>Signature</i>     |
|----------------------|---------------|-----------------|-------------|----------------------|
| <i>Prepared by :</i> | Jérôme LUC    | Product Manager | 10/12/2021  | <i>JS</i>            |
| <i>Checked by :</i>  | Jérôme LUC    | Product Manager | 10/12/2021  | <i>JS</i>            |
| <i>Approved by :</i> | Kim RUTKOWSKI | Quality Manager | 10/12/2021  | <i>Kim Rutkowski</i> |

|                       | <i>Customer Name</i>                                  |
|-----------------------|---|
| <i>Distribution :</i> | Shenzhen LCS<br>Compliance Testing<br>Laboratory Ltd. |

| <i>Issue</i> | <i>Date</i> | <i>Modifications</i> |
|--------------|-------------|----------------------|
| A            | 10/12/2021  | Initial release      |
|              |             |                      |
|              |             |                      |

*This document shall not be reproduced, except in full or in part, without the written approval of SATIMO.  
The information contained herein is to be used only for the purpose for which it is submitted and is not to be released in whole or part without written approval of SATIMO.*

股份  
g Lab







股份  
g Lab

TABLE OF CONTENTS

1 Introduction.....4

2 Device Under Test .....4

3 Product Description .....4

    3.1 General Information ..... 4

4 Measurement Method .....5

    4.1 Return Loss Requirements ..... 5

    4.2 Mechanical Requirements ..... 5

5 Measurement Uncertainty.....5

    5.1 Return Loss ..... 5

    5.2 Dimension Measurement ..... 5

    5.3 Validation Measurement ..... 5

6 Calibration Measurement Results .....6

    6.1 Return Loss and Impedance ..... 6

    6.2 Mechanical Dimensions ..... 6

7 Validation measurement .....7

    7.1 Head Liquid Measurement ..... 7

    7.2 SAR Measurement Result With Head Liquid ..... 7

    7.3 Body Liquid Measurement ..... 9

    7.4 SAR Measurement Result With Body Liquid ..... 9

8 List of Equipment ..... 11

股份  
g Lab

*This document shall not be reproduced, except in full or in part, without the written approval of SATIMO.  
The information contained herein is to be used only for the purpose for which it is submitted and is not to be released in whole or part without written approval of SATIMO.*

股份  
g Lab



## 1 INTRODUCTION

This document contains a summary of the requirements set forth by the IEEE 1528, OET 65 Bulletin C and CEI/IEC 62209 standards for reference dipoles used for SAR measurement system validations and the measurements that were performed to verify that the product complies with the fore mentioned standards.

## 2 DEVICE UNDER TEST

| Device Under Test              |                                   |
|--------------------------------|-----------------------------------|
| Device Type                    | COMOSAR 2450 MHz REFERENCE DIPOLE |
| Manufacturer                   | Satimo                            |
| Model                          | SID2450                           |
| Serial Number                  | SN 07/14 DIP 2G450-306            |
| Product Condition (new / used) | New                               |

A yearly calibration interval is recommended.

## 3 PRODUCT DESCRIPTION

### 3.1 GENERAL INFORMATION

Satimo's COMOSAR Validation Dipoles are built in accordance to the IEEE 1528, OET 65 Bulletin C and CEI/IEC 62209 standards. The product is designed for use with the COMOSAR test bench only.



Figure 1 – Satimo COMOSAR Validation Dipole

Page: 4/11

*This document shall not be reproduced, except in full or in part, without the written approval of SATIMO.  
The information contained herein is to be used only for the purpose for which it is submitted and is not to be released in whole or part without written approval of SATIMO.*





股份  
g Lab

#### 4 MEASUREMENT METHOD

The IEEE 1528, OET 65 Bulletin C and CEI/IEC 62209 standards provide requirements for reference dipoles used for system validation measurements. The following measurements were performed to verify that the product complies with the fore mentioned standards.

##### 4.1 RETURN LOSS REQUIREMENTS

The dipole used for SAR system validation measurements and checks must have a return loss of -20 dB or better. The return loss measurement shall be performed against a liquid filled flat phantom, with the phantom constructed as outlined in the fore mentioned standards.

##### 4.2 MECHANICAL REQUIREMENTS

The IEEE Std. 1528 and CEI/IEC 62209 standards specify the mechanical components and dimensions of the validation dipoles, with the dimensions frequency and phantom shell thickness dependent. The COMOSAR test bench employs a 2 mm phantom shell thickness therefore the dipoles sold for use with the COMOSAR test bench comply with the requirements set forth for a 2 mm phantom shell thickness.

#### 5 MEASUREMENT UNCERTAINTY

All uncertainties listed below represent an expanded uncertainty expressed at approximately the 95% confidence level using a coverage factor of k=2, traceable to the Internationally Accepted Guides to Measurement Uncertainty.

##### 5.1 RETURN LOSS

The following uncertainties apply to the return loss measurement:

| Frequency band | Expanded Uncertainty on Return Loss |
|----------------|-------------------------------------|
| 400-6000MHz    | 0.1 dB                              |

##### 5.2 DIMENSION MEASUREMENT

The following uncertainties apply to the dimension measurements:

| Length (mm) | Expanded Uncertainty on Length |
|-------------|--------------------------------|
| 3 - 300     | 0.05 mm                        |

##### 5.3 VALIDATION MEASUREMENT

The guidelines outlined in the IEEE 1528, OET 65 Bulletin C, CENELEC EN50361 and CEI/IEC 62209 standards were followed to generate the measurement uncertainty for validation measurements.

| Scan Volume | Expanded Uncertainty |
|-------------|----------------------|
| 1 g         | 20.3 %               |
| 10 g        | 20.1 %               |

Page: 5/11

*This document shall not be reproduced, except in full or in part, without the written approval of SATIMO. The information contained herein is to be used only for the purpose for which it is submitted and is not to be released in whole or part without written approval of SATIMO.*

股份  
g Lab

股份  
g Lab







股份  
g Lab

## 6 CALIBRATION MEASUREMENT RESULTS

### 6.1 RETURN LOSS AND IMPEDANCE

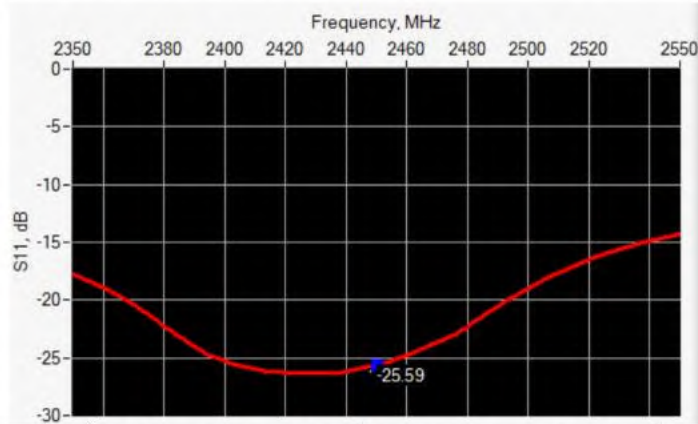

| Frequency (MHz) | Return Loss (dB) | Requirement (dB) | Impedance       |
|-----------------|------------------|------------------|-----------------|
| 2450            | -25.59           | -20              | 44.7 Ω - 1.1 jΩ |

### 6.2 MECHANICAL DIMENSIONS

| Frequency MHz | L mm        |          | h mm        |          | d mm       |          |
|---------------|-------------|----------|-------------|----------|------------|----------|
|               | required    | measured | required    | measured | required   | measured |
| 300           | 420.0 ±1 %. |          | 250.0 ±1 %. |          | 6.35 ±1 %. |          |
| 450           | 290.0 ±1 %. |          | 166.7 ±1 %. |          | 6.35 ±1 %. |          |
| 750           | 176.0 ±1 %. |          | 100.0 ±1 %. |          | 6.35 ±1 %. |          |
| 835           | 161.0 ±1 %. |          | 89.8 ±1 %.  |          | 3.6 ±1 %.  |          |
| 900           | 149.0 ±1 %. |          | 83.3 ±1 %.  |          | 3.6 ±1 %.  |          |
| 1450          | 89.1 ±1 %.  |          | 51.7 ±1 %.  |          | 3.6 ±1 %.  |          |
| 1500          | 80.5 ±1 %.  |          | 50.0 ±1 %.  |          | 3.6 ±1 %.  |          |
| 1640          | 79.0 ±1 %.  |          | 45.7 ±1 %.  |          | 3.6 ±1 %.  |          |
| 1750          | 75.2 ±1 %.  |          | 42.9 ±1 %.  |          | 3.6 ±1 %.  |          |
| 1800          | 72.0 ±1 %.  |          | 41.7 ±1 %.  |          | 3.6 ±1 %.  |          |
| 1900          | 68.0 ±1 %.  |          | 39.5 ±1 %.  |          | 3.6 ±1 %.  |          |
| 1950          | 66.3 ±1 %.  |          | 38.5 ±1 %.  |          | 3.6 ±1 %.  |          |
| 2000          | 64.5 ±1 %.  |          | 37.5 ±1 %.  |          | 3.6 ±1 %.  |          |
| 2100          | 61.0 ±1 %.  |          | 35.7 ±1 %.  |          | 3.6 ±1 %.  |          |
| 2300          | 55.5 ±1 %.  |          | 32.6 ±1 %.  |          | 3.6 ±1 %.  |          |
| 2450          | 51.5 ±1 %.  | PASS     | 30.4 ±1 %.  | PASS     | 3.6 ±1 %.  | PASS     |
| 2600          | 48.5 ±1 %.  |          | 28.8 ±1 %.  |          | 3.6 ±1 %.  |          |
| 3000          | 41.5 ±1 %.  |          | 25.0 ±1 %.  |          | 3.6 ±1 %.  |          |
| 3500          | 37.0 ±1 %.  |          | 26.4 ±1 %.  |          | 3.6 ±1 %.  |          |
| 3700          | 34.7 ±1 %.  |          | 26.4 ±1 %.  |          | 3.6 ±1 %.  |          |

*This document shall not be reproduced, except in full or in part, without the written approval of SATIMO.  
 The information contained herein is to be used only for the purpose for which it is submitted and is not to be released in whole or part without written approval of SATIMO.*

股份  
g Lab

股份  
g Lab







股份  
g Lab

### 7 VALIDATION MEASUREMENT

The IEEE Std. 1528, OET 65 Bulletin C and CEI/IEC 62209 standards state that the system validation measurements must be performed using a reference dipole meeting the fore mentioned return loss and mechanical dimension requirements. The validation measurement must be performed against a liquid filled flat phantom, with the phantom constructed as outlined in the fore mentioned standards. Per the standards, the dipole shall be positioned below the bottom of the phantom, with the dipole length centered and parallel to the longest dimension of the flat phantom, with the top surface of the dipole at the described distance from the bottom surface of the phantom.

#### 7.1 HEAD LIQUID MEASUREMENT

| Frequency<br>MHz | Relative permittivity ( $\epsilon_r$ ) |          | Conductivity ( $\sigma$ ) S/m |          |
|------------------|--|----------|-------------------------------|----------|
|                  | required                               | measured | required                      | measured |
| 300              | 45.3 ±5 %                              |          | 0.87 ±5 %                     |          |
| 450              | 43.5 ±5 %                              |          | 0.87 ±5 %                     |          |
| 750              | 41.9 ±5 %                              |          | 0.89 ±5 %                     |          |
| 835              | 41.5 ±5 %                              |          | 0.90 ±5 %                     |          |
| 900              | 41.5 ±5 %                              |          | 0.97 ±5 %                     |          |
| 1450             | 40.5 ±5 %                              |          | 1.20 ±5 %                     |          |
| 1500             | 40.4 ±5 %                              |          | 1.23 ±5 %                     |          |
| 1640             | 40.2 ±5 %                              |          | 1.31 ±5 %                     |          |
| 1750             | 40.1 ±5 %                              |          | 1.37 ±5 %                     |          |
| 1800             | 40.0 ±5 %                              |          | 1.40 ±5 %                     |          |
| 1900             | 40.0 ±5 %                              |          | 1.40 ±5 %                     |          |
| 1950             | 40.0 ±5 %                              |          | 1.40 ±5 %                     |          |
| 2000             | 40.0 ±5 %                              |          | 1.40 ±5 %                     |          |
| 2100             | 39.8 ±5 %                              |          | 1.49 ±5 %                     |          |
| 2300             | 39.5 ±5 %                              |          | 1.67 ±5 %                     |          |
| 2450             | 39.2 ±5 %                              | PASS     | 1.80 ±5 %                     | PASS     |
| 2600             | 39.0 ±5 %                              |          | 1.96 ±5 %                     |          |
| 3000             | 38.5 ±5 %                              |          | 2.40 ±5 %                     |          |
| 3500             | 37.9 ±5 %                              |          | 2.91 ±5 %                     |          |

股份  
g Lab

#### 7.2 SAR MEASUREMENT RESULT WITH HEAD LIQUID

The IEEE Std. 1528 and CEI/IEC 62209 standards state that the system validation measurements should produce the SAR values shown below (for phantom thickness of 2 mm), within the uncertainty for the system validation. All SAR values are normalized to 1 W forward power. In bracket, the measured SAR is given with the used input power.

|   |   |
|---|---|
| Software                                  | OPENSAR V4  |
| Phantom                                   | SN 20/09 SAM71  |
| Probe                                     | SN 18/11 EPG122   |
| Liquid                                    | Head Liquid Values: $\epsilon_r$ : 39.0 $\sigma$ : 1.77 |
| Distance between dipole center and liquid | 10.0 mm   |
| Area scan resolution                      | dx=8mm/dy=8mm   |

*This document shall not be reproduced, except in full or in part, without the written approval of SATIMO. The information contained herein is to be used only for the purpose for which it is submitted and is not to be released in whole or part without written approval of SATIMO.*

股份  
g Lab





SAR REFERENCE DIPOLE CALIBRATION REPORT

Ref: ACR.287.8.14.SATU.A

股份  
g Lab

|                      |                      |
|----------------------|----------------------|
| Zoon Scan Resolution | dx=8mm/dy=8mm/dz=5mm |
| Frequency            | 2450 MHz             |
| Input power          | 20 dBm               |
| Liquid Temperature   | 21 °C                |
| Lab Temperature      | 21 °C                |
| Lab Humidity         | 45 %                 |

| Frequency MHz | 1 g SAR (W/kg/W) |              | 10 g SAR (W/kg/W) |              |
|---------------|------------------|--------------|-------------------|--------------|
|               | required         | measured     | required          | measured     |
| 300           | 2.85             |              | 1.94              |              |
| 450           | 4.58             |              | 3.06              |              |
| 750           | 8.49             |              | 5.55              |              |
| 835           | 9.56             |              | 6.22              |              |
| 900           | 10.9             |              | 6.99              |              |
| 1450          | 29               |              | 16                |              |
| 1500          | 30.5             |              | 16.8              |              |
| 1640          | 34.2             |              | 18.4              |              |
| 1750          | 36.4             |              | 19.3              |              |
| 1800          | 38.4             |              | 20.1              |              |
| 1900          | 39.7             |              | 20.5              |              |
| 1950          | 40.5             |              | 20.9              |              |
| 2000          | 41.1             |              | 21.1              |              |
| 2100          | 43.6             |              | 21.9              |              |
| 2300          | 48.7             |              | 23.3              |              |
| 2450          | 52.4             | 53.89 (5.39) | 24                | 24.15 (2.42) |
| 2600          | 55.3             |              | 24.6              |              |
| 3000          | 63.8             |              | 25.7              |              |
| 3500          | 67.1             |              | 25                |              |

股份  
g Lab

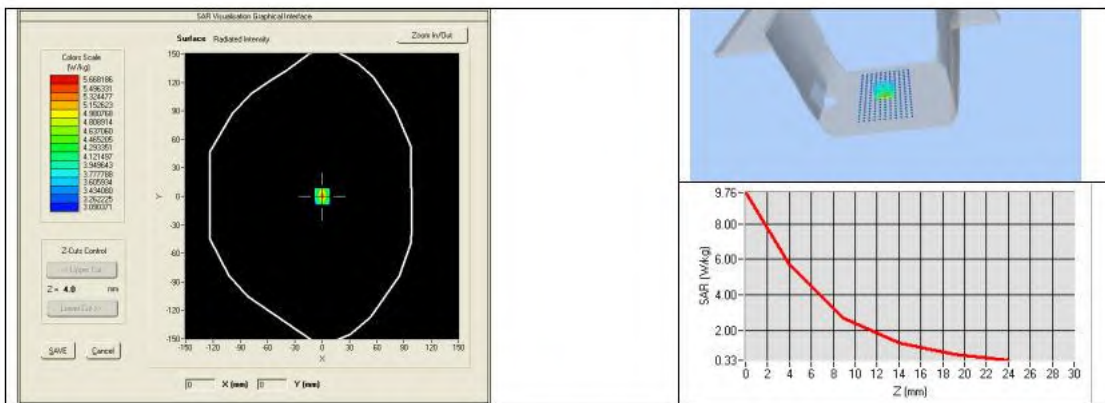

This document shall not be reproduced, except in full or in part, without the written approval of SATIMO. The information contained herein is to be used only for the purpose for which it is submitted and is not to be released in whole or part without written approval of SATIMO.

股份  
g Lab





## SAR REFERENCE DIPOLE CALIBRATION REPORT

Ref: ACR.287.8.14.SATU.A

股份  
g Lab

## 7.3 BODY LIQUID MEASUREMENT

| Frequency<br>MHz | Relative permittivity ( $\epsilon_r'$ ) |          | Conductivity ( $\sigma$ ) S/m |          |
|------------------|---|----------|-------------------------------|----------|
|                  | required                                | measured | required                      | measured |
| 150              | 61.9 ±5 %                               |          | 0.80 ±5 %                     |          |
| 300              | 58.2 ±5 %                               |          | 0.92 ±5 %                     |          |
| 450              | 56.7 ±5 %                               |          | 0.94 ±5 %                     |          |
| 750              | 55.5 ±5 %                               |          | 0.96 ±5 %                     |          |
| 835              | 55.2 ±5 %                               |          | 0.97 ±5 %                     |          |
| 900              | 55.0 ±5 %                               |          | 1.05 ±5 %                     |          |
| 915              | 55.0 ±5 %                               |          | 1.06 ±5 %                     |          |
| 1450             | 54.0 ±5 %                               |          | 1.30 ±5 %                     |          |
| 1610             | 53.8 ±5 %                               |          | 1.40 ±5 %                     |          |
| 1800             | 53.3 ±5 %                               |          | 1.52 ±5 %                     |          |
| 1900             | 53.3 ±5 %                               |          | 1.52 ±5 %                     |          |
| 2000             | 53.3 ±5 %                               |          | 1.52 ±5 %                     |          |
| 2100             | 53.2 ±5 %                               |          | 1.62 ±5 %                     |          |
| 2450             | 52.7 ±5 %                               | PASS     | 1.95 ±5 %                     | PASS     |
| 2600             | 52.5 ±5 %                               |          | 2.16 ±5 %                     |          |
| 3000             | 52.0 ±5 %                               |          | 2.73 ±5 %                     |          |
| 3500             | 51.3 ±5 %                               |          | 3.31 ±5 %                     |          |
| 5200             | 49.0 ±10 %                              |          | 5.30 ±10 %                    |          |
| 5300             | 48.9 ±10 %                              |          | 5.42 ±10 %                    |          |
| 5400             | 48.7 ±10 %                              |          | 5.53 ±10 %                    |          |
| 5500             | 48.6 ±10 %                              |          | 5.65 ±10 %                    |          |
| 5600             | 48.5 ±10 %                              |          | 5.77 ±10 %                    |          |
| 5800             | 48.2 ±10 %                              |          | 6.00 ±10 %                    |          |

股份  
g Lab

## 7.4 SAR MEASUREMENT RESULT WITH BODY LIQUID

|   |   |
|---|---|
| Software                                  | OPENSAR V4  |
| Phantom                                   | SN 20/09 SAM71  |
| Probe                                     | SN 18/11 EPG122                                       |
| Liquid                                    | Body Liquid Values: $\epsilon_r'$ : 53.0 sigma : 1.93 |
| Distance between dipole center and liquid | 10.0 mm   |
| Area scan resolution                      | dx=8mm/dy=8mm   |
| Zoon Scan Resolution                      | dx=8mm/dy=8mm/dz=5mm                                  |
| Frequency                                 | 2450 MHz  |
| Input power                               | 20 dBm  |
| Liquid Temperature                        | 21 °C   |
| Lab Temperature                           | 21 °C   |
| Lab Humidity                              | 45 %  |

Page: 9/11

*This document shall not be reproduced, except in full or in part, without the written approval of SATIMO.  
The information contained herein is to be used only for the purpose for which it is submitted and is not to  
be released in whole or part without written approval of SATIMO.*

股份  
g Lab



SAR REFERENCE DIPOLE CALIBRATION REPORT

Ref: E-ACR.287.8.14.SATU.A

股份  
g Lab

| Frequency MHz | 1 g SAR (W/kg/W) | 10 g SAR (W/kg/W) |
|---------------|------------------|-------------------|
|               | measured         | measured          |
| 2450          | 54.65 (5.46)     | 24.58 (2.46)      |

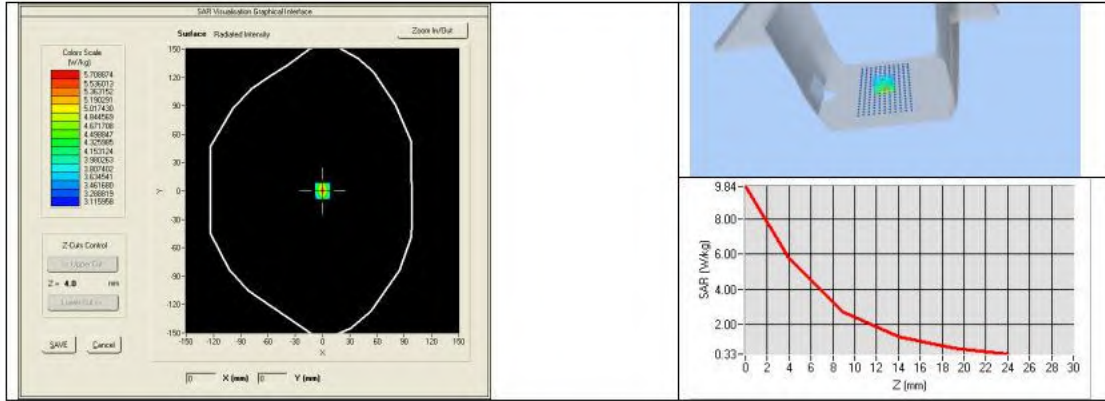

股份  
g Lab

This document shall not be reproduced, except in full or in part, without the written approval of SATIMO. The information contained herein is to be used only for the purpose for which it is submitted and is not to be released in whole or part without written approval of SATIMO.

股份  
g Lab







SAR REFERENCE DIPOLE CALIBRATION REPORT

Ref: ACR.287.8.14.SATU.A

股份  
ig Lab

| Frequency MHz | 1 g SAR (W/kg/W) | 10 g SAR (W/kg/W) |
|---------------|------------------|-------------------|
|               | measured         | measured          |
| 2450          | 54.65 (5.46)     | 24.58 (2.46)      |

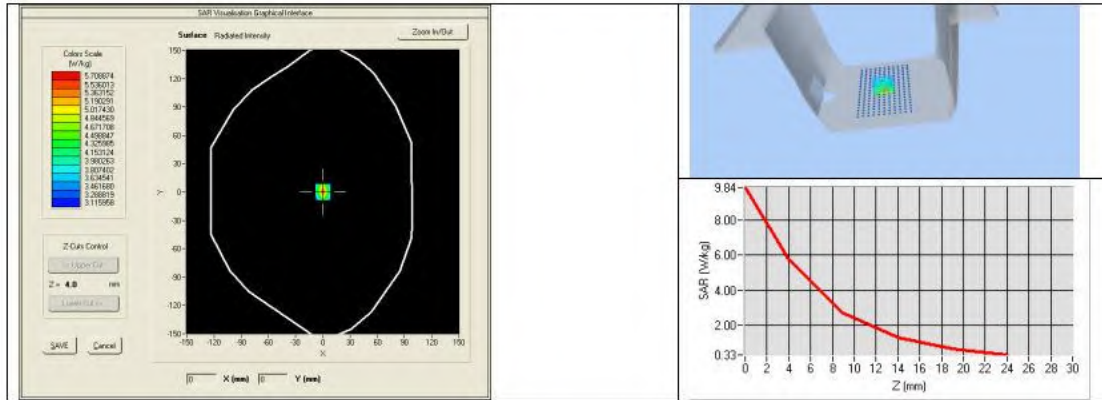

股份  
ig Lab

*This document shall not be reproduced, except in full or in part, without the written approval of SATIMO. The information contained herein is to be used only for the purpose for which it is submitted and is not to be released in whole or part without written approval of SATIMO.*

股份  
ig Lab



股份  
ig Lab

## 8 LIST OF EQUIPMENT

| Equipment Summary Sheet         |                      |                    |   |   |
|---------------------------------|----------------------|--------------------|---|---|
| Equipment Description           | Manufacturer / Model | Identification No. | Current Calibration Date                      | Next Calibration Date                         |
| SAM Phantom                     | Satimo               | SN-20/09-SAM71     | Validated. No cal required.                   | Validated. No cal required.                   |
| COMOSAR Test Bench              | Version 3            | NA                 | Validated. No cal required.                   | Validated. No cal required.                   |
| Network Analyzer                | Rhode & Schwarz ZVA  | SN100132           | 02/2021                                       | 02/2024                                       |
| Calipers                        | Carrera              | CALIPER-01         | 12/2018                                       | 12/2021                                       |
| Reference Probe                 | Satimo               | EPG122 SN 18/11    | 10/2021                                       | 10/2022                                       |
| Multimeter                      | Keithley 2000        | 1188656            | 12/2018                                       | 12/2021                                       |
| Signal Generator                | Agilent E4438C       | MY49070581         | 12/2018                                       | 12/2021                                       |
| Amplifier                       | Aethercomm           | SN 046             | Characterized prior to test. No cal required. | Characterized prior to test. No cal required. |
| Power Meter                     | HP E4418A            | US38261498         | 12/2018                                       | 12/2021                                       |
| Power Sensor                    | HP ECP-E26A          | US37181460         | 12/2018                                       | 12/2021                                       |
| Directional Coupler             | Narda 4216-20        | 01386              | Characterized prior to test. No cal required. | Characterized prior to test. No cal required. |
| Temperature and Humidity Sensor | Control Company      | 11-661-9           | 8/2021  | 8/2024  |

股份  
ig Lab

Page: 11/11

*This document shall not be reproduced, except in full or in part, without the written approval of SATIMO. The information contained herein is to be used only for the purpose for which it is submitted and is not to be released in whole or part without written approval of SATIMO.*

股份  
ig Lab



### 5.3 SID5-6G Dipole Calibration Certificate



## SAR Reference Waveguide Calibration Report

Ref: ACR.273.5.18.SATU.A

**SHENZHEN LCS COMPLIANCE TESTING  
LABORATORY LTD.**  
**1F., XINGYUAN INDUSTRIAL PARK, TONGDA  
ROAD, BAO'AN BLVD BAO'AN DISTRICT,  
SHENZHEN, GUANGDONG, CHINA**  
**MVG COMOSAR  
REFERENCE WAVEGUIDE**  
**FREQUENCY: 5000-6000 MHZ**  
**SERIAL NO.: SN 49/16 WGA 43**

**Calibrated at MVG US**  
**2105 Barrett Park Dr. - Kennesaw, GA 30144**



**Calibration Date: 09/22/2021**

*Summary:*

This document presents the method and results from an accredited SAR reference waveguide calibration performed in MVG USA using the COMOSAR test bench. All calibration results are traceable to national metrology institutions.



股份  
ing Lab

股份  
ing Lab

股份  
ing Lab



SAR REFERENCE WAVEGUIDE CALIBRATION REPORT

Ref: ACR.273.5.18.SATU.A

股份  
g Lab

|                      | <i>Name</i>   | <i>Function</i> | <i>Date</i> | <i>Signature</i>     |
|----------------------|---------------|-----------------|-------------|----------------------|
| <i>Prepared by :</i> | Jérôme LUC    | Product Manager | 09/28/2021  | <i>JS</i>            |
| <i>Checked by :</i>  | Jérôme LUC    | Product Manager | 09/28/2021  | <i>JS</i>            |
| <i>Approved by :</i> | Kim RUTKOWSKI | Quality Manager | 09/28/2021  | <i>Kim Rutkowski</i> |

|                       | <i>Customer Name</i>                                  |
|-----------------------|---|
| <i>Distribution :</i> | Shenzhen LCS<br>Compliance Testing<br>Laboratory Ltd. |

股份  
g Lab

| <i>Issue</i> | <i>Date</i> | <i>Modifications</i> |
|--------------|-------------|----------------------|
| A            | 09/28/2021  | Initial release      |
|              |             |                      |
|              |             |                      |

*This document shall not be reproduced, except in full or in part, without the written approval of MVG.  
The information contained herein is to be used only for the purpose for which it is submitted and is not to be released in whole or part without written approval of MVG.*

股份  
g Lab







SAR REFERENCE WAVEGUIDE CALIBRATION REPORT

Ref: ACR.273.5.18.SATU.A

股份  
g Lab

TABLE OF CONTENTS

1 Introduction.....4

2 Device Under Test .....4

3 Product Description .....4

    3.1 General Information ..... 4

4 Measurement Method .....4

    4.1 Return Loss Requirements ..... 4

    4.2 Mechanical Requirements ..... 4

5 Measurement Uncertainty.....5

    5.1 Return Loss ..... 5

    5.2 Dimension Measurement ..... 5

    5.3 Validation Measurement ..... 5

6 Calibration Measurement Results ..... 5

    6.1 Return Loss ..... 5

    6.2 Mechanical Dimensions ..... 6

7 Validation measurement ..... 7

    7.1 Head Liquid Measurement ..... 7

    7.2 Measurement Result ..... 7

    7.3 Body Measurement Result ..... 10

8 List of Equipment ..... 13

股份  
g Lab

*This document shall not be reproduced, except in full or in part, without the written approval of MVG.  
The information contained herein is to be used only for the purpose for which it is submitted and is not to be released in whole or part without written approval of MVG.*

股份  
g Lab





SAR REFERENCE WAVEGUIDE CALIBRATION REPORT

Ref: ACR.273.5.18.SATU.A

股份  
ig Lab

1 INTRODUCTION

This document contains a summary of the requirements set forth by the IEEE 1528 and CEI/IEC 62209 standards for reference waveguides used for SAR measurement system validations and the measurements that were performed to verify that the product complies with the fore mentioned standards.

2 DEVICE UNDER TEST

| Device Under Test              |   |
|--------------------------------|---|
| Device Type                    | COMOSAR 5000-6000 MHz REFERENCE WAVEGUIDE |
| Manufacturer                   | MVG                                       |
| Model                          | SWG5500                                   |
| Serial Number                  | SN 49/16 WGA 43                           |
| Product Condition (new / used) | Used                                      |

A yearly calibration interval is recommended.

3 PRODUCT DESCRIPTION

3.1 GENERAL INFORMATION

MVG's COMOSAR Validation Waveguides are built in accordance to the IEEE 1528 and CEI/IEC 62209 standards.

4 MEASUREMENT METHOD

The IEEE 1528 and CEI/IEC 62209 standards provide requirements for reference waveguides used for system validation measurements. The following measurements were performed to verify that the product complies with the fore mentioned standards.

4.1 RETURN LOSS REQUIREMENTS

The waveguide used for SAR system validation measurements and checks must have a return loss of -8 dB or better. The return loss measurement shall be performed with matching layer placed in the open end of the waveguide, with the waveguide and matching layer in direct contact with the phantom shell as outlined in the fore mentioned standards.

4.2 MECHANICAL REQUIREMENTS

The IEEE 1528 and CEI/IEC 62209 standards specify the mechanical dimensions of the validation waveguide, the specified dimensions are as shown in Section 6.2. Figure 1 shows how the dimensions relate to the physical construction of the waveguide.

This document shall not be reproduced, except in full or in part, without the written approval of MVG. The information contained herein is to be used only for the purpose for which it is submitted and is not to be released in whole or part without written approval of MVG.

股份  
ig Lab



股份  
ig Lab



股份  
ig Lab

## 5 MEASUREMENT UNCERTAINTY

All uncertainties listed below represent an expanded uncertainty expressed at approximately the 95% confidence level using a coverage factor of  $k=2$ , traceable to the Internationally Accepted Guides to Measurement Uncertainty.

### 5.1 RETURN LOSS

The following uncertainties apply to the return loss measurement:

| Frequency band | Expanded Uncertainty on Return Loss |
|----------------|-------------------------------------|
| 400-6000MHz    | 0.1 dB                              |

### 5.2 DIMENSION MEASUREMENT

The following uncertainties apply to the dimension measurements:

| Length (mm) | Expanded Uncertainty on Length |
|-------------|--------------------------------|
| 3 - 300     | 0.05 mm                        |

### 5.3 VALIDATION MEASUREMENT

The guidelines outlined in the IEEE 1528 and CEI/IEC 62209 standards were followed to generate the measurement uncertainty for validation measurements.

| Scan Volume | Expanded Uncertainty |
|-------------|----------------------|
| 1 g         | 20.3 %               |
| 10 g        | 20.1 %               |

股份  
ig Lab

## 6 CALIBRATION MEASUREMENT RESULTS

### 6.1 RETURN LOSS IN HEAD LIQUID

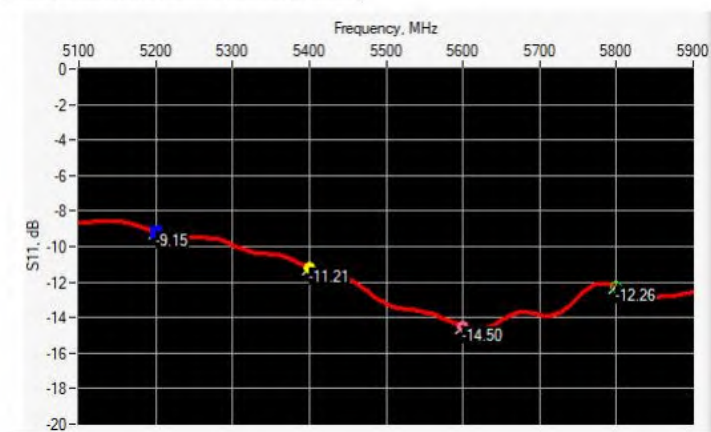

Page: 5/13

*This document shall not be reproduced, except in full or in part, without the written approval of MVG. The information contained herein is to be used only for the purpose for which it is submitted and is not to be released in whole or part without written approval of MVG.*

股份  
ig Lab







SAR REFERENCE WAVEGUIDE CALIBRATION REPORT

Ref: ACR.273.5.18.SATU.A

股份  
ig Lab

| Frequency (MHz) | Return Loss (dB) | Requirement (dB) | Impedance          |
|-----------------|------------------|------------------|--------------------|
| 5200            | -9.15            | -8               | 20.57 Ω + 11.55 jΩ |
| 5400            | -11.21           | -8               | 75.27 Ω + 4.08 jΩ  |
| 5600            | -14.50           | -8               | 33.91 Ω - 8.72 jΩ  |
| 5800            | -12.26           | -8               | 53.07 Ω + 23.41 jΩ |

6.2 RETURN LOSS IN BODY LIQUID

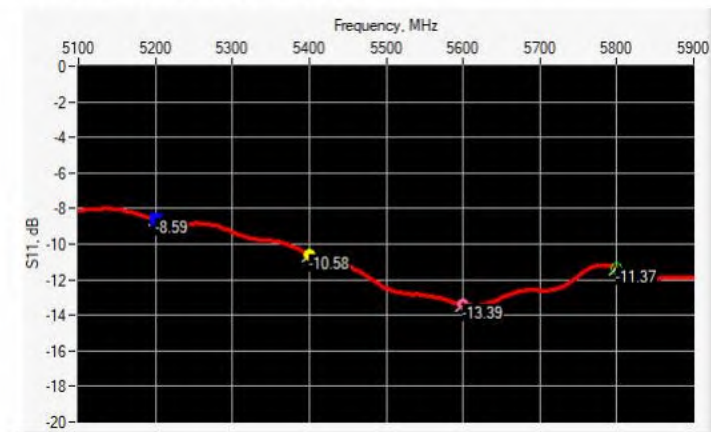

| Frequency (MHz) | Return Loss (dB) | Requirement (dB) | Impedance          |
|-----------------|------------------|------------------|--------------------|
| 5200            | -8.59            | -8               | 19.38 Ω + 13.50 jΩ |
| 5400            | -10.58           | -8               | 77.13 Ω + 1.81 jΩ  |
| 5600            | -13.39           | -8               | 30.95 Ω - 7.75 jΩ  |
| 5800            | -11.37           | -8               | 54.79 Ω + 25.47 jΩ |

6.3 MECHANICAL DIMENSIONS

| Frequency (MHz) | L (mm)       |          | W (mm)       |          | L <sub>r</sub> (mm) |          | W <sub>r</sub> (mm) |          | T (mm)   |          |
|-----------------|--------------|----------|--------------|----------|---------------------|----------|---------------------|----------|----------|----------|
|                 | Required     | Measured | Required     | Measured | Required            | Measured | Required            | Measured | Required | Measured |
| 5200            | 40.39 ± 0.13 | PASS     | 20.19 ± 0.13 | PASS     | 81.03 ± 0.13        | PASS     | 61.98 ± 0.13        | PASS     | 5.3*     | PASS     |
| 5800            | 40.39 ± 0.13 | PASS     | 20.19 ± 0.13 | PASS     | 81.03 ± 0.13        | PASS     | 61.98 ± 0.13        | PASS     | 4.3*     | PASS     |

\* The tolerance for the matching layer is included in the return loss measurement.

股份  
ig Lab





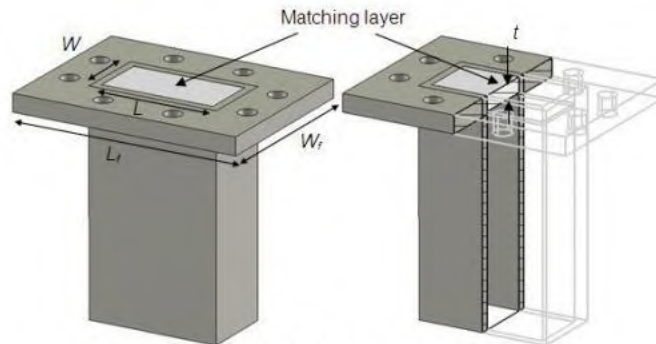

Figure 1: Validation Waveguide Dimensions

## 7 VALIDATION MEASUREMENT

The IEEE Std. 1528 and CEI/IEC 62209 standards state that the system validation measurements must be performed using a reference waveguide meeting the fore mentioned return loss and mechanical dimension requirements. The validation measurement must be performed with the matching layer placed in the open end of the waveguide, with the waveguide and matching layer in direct contact with the phantom shell.

### 7.1 HEAD LIQUID MEASUREMENT

| Frequency<br>MHz | Relative permittivity ( $\epsilon_r$ ) |          | Conductivity ( $\sigma$ ) S/m |          |
|------------------|--|----------|-------------------------------|----------|
|                  | required                               | measured | required                      | measured |
| 5000             | 36.2 $\pm$ 10 %                        |          | 4.45 $\pm$ 10 %               |          |
| 5100             | 36.1 $\pm$ 10 %                        |          | 4.56 $\pm$ 10 %               |          |
| 5200             | 36.0 $\pm$ 10 %                        | PASS     | 4.66 $\pm$ 10 %               | PASS     |
| 5300             | 35.9 $\pm$ 10 %                        |          | 4.76 $\pm$ 10 %               |          |
| 5400             | 35.8 $\pm$ 10 %                        | PASS     | 4.86 $\pm$ 10 %               | PASS     |
| 5500             | 35.6 $\pm$ 10 %                        |          | 4.97 $\pm$ 10 %               |          |
| 5600             | 35.5 $\pm$ 10 %                        | PASS     | 5.07 $\pm$ 10 %               | PASS     |
| 5700             | 35.4 $\pm$ 10 %                        |          | 5.17 $\pm$ 10 %               |          |
| 5800             | 35.3 $\pm$ 10 %                        | PASS     | 5.27 $\pm$ 10 %               | PASS     |
| 5900             | 35.2 $\pm$ 10 %                        |          | 5.38 $\pm$ 10 %               |          |
| 6000             | 35.1 $\pm$ 10 %                        |          | 5.48 $\pm$ 10 %               |          |

### 7.2 SAR MEASUREMENT RESULT WITH HEAD LIQUID

At those frequencies, the target SAR value can not be generic. Hereunder is the target SAR value defined by MVG, within the uncertainty for the system validation. All SAR values are normalized to 1 W net power. In bracket, the measured SAR is given with the used input power.

Page: 7/13

*This document shall not be reproduced, except in full or in part, without the written approval of MVG.  
The information contained herein is to be used only for the purpose for which it is submitted and is not to be released in whole or part without written approval of MVG.*





SAR REFERENCE WAVEGUIDE CALIBRATION REPORT

Ref: ACR.273.5.18.SATU.A

股份  
g Lab

|  |  |
|--|--|
| Software                                     | OPENSAR V4   |
| Phantom                                      | SN 20/09 SAM71   |
| Probe  | SN 18/11 EPG122  |
| Liquid                                       | Head Liquid Values 5200 MHz: eps':35.64 sigma : 4.67<br>Head Liquid Values 5400 MHz: eps':36.44 sigma : 4.87<br>Head Liquid Values 5600 MHz: eps':36.66 sigma : 5.17<br>Head Liquid Values 5800 MHz: eps':35.31 sigma : 5.31 |
| Distance between dipole waveguide and liquid | 0 mm   |
| Area scan resolution                         | dx=8mm/dy=8mm  |
| Zoon Scan Resolution                         | dx=4mm/dy=4m/dz=2mm  |
| Frequency                                    | 5200 MHz<br>5400 MHz<br>5600 MHz<br>5800 MHz   |
| Input power                                  | 20 dBm   |
| Liquid Temperature                           | 21 °C  |
| Lab Temperature                              | 21 °C  |
| Lab Humidity                                 | 45 %   |

| Frequency (MHz) | 1 g SAR (W/kg) |                | 10 g SAR (W/kg) |              |
|-----------------|----------------|----------------|-----------------|--------------|
|                 | required       | measured       | required        | measured     |
| 5200            | 159.00         | 165.77 (16.58) | 56.90           | 57.20 (5.72) |
| 5400            | 166.40         | 173.20 (17.32) | 58.43           | 59.22 (5.92) |
| 5600            | 173.80         | 179.61 (17.96) | 59.97           | 60.98 (6.10) |
| 5800            | 181.20         | 186.77 (18.68) | 61.50           | 62.84 (6.28) |

股份  
g Lab

SAR MEASUREMENT PLOTS @ 5200 MHz

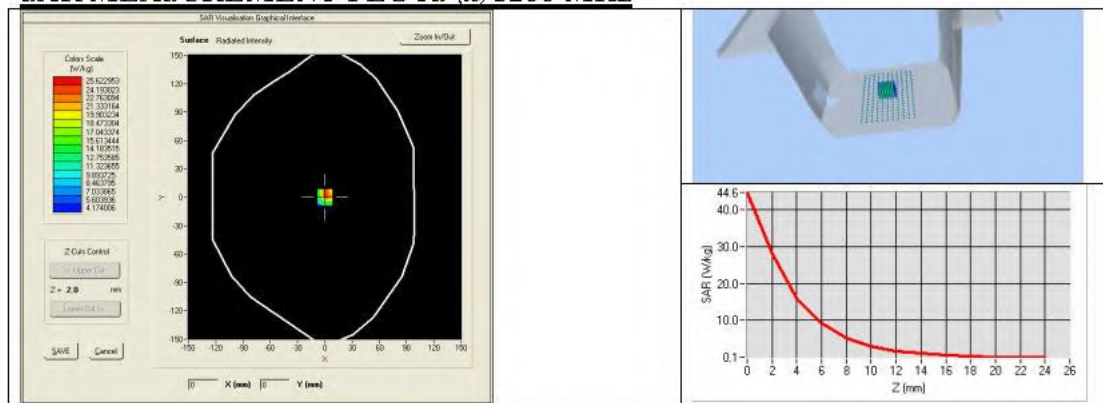

This document shall not be reproduced, except in full or in part, without the written approval of MVG.  
The information contained herein is to be used only for the purpose for which it is submitted and is not to be released in whole or part without written approval of MVG.

股份  
g Lab





SAR REFERENCE WAVEGUIDE CALIBRATION REPORT

Ref: ACR.273.5.18.SATU.A

股份 g Lab

SAR MEASUREMENT PLOTS @ 5400 MHz

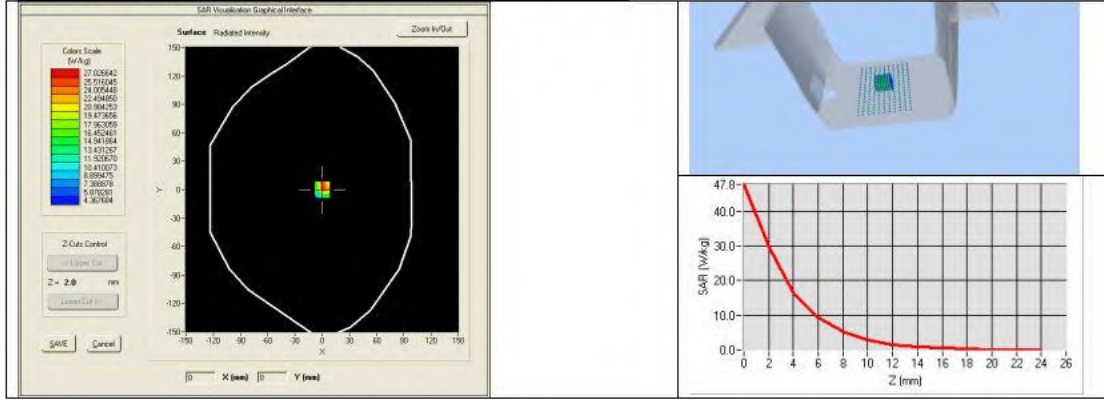

SAR MEASUREMENT PLOTS @ 5600 MHz

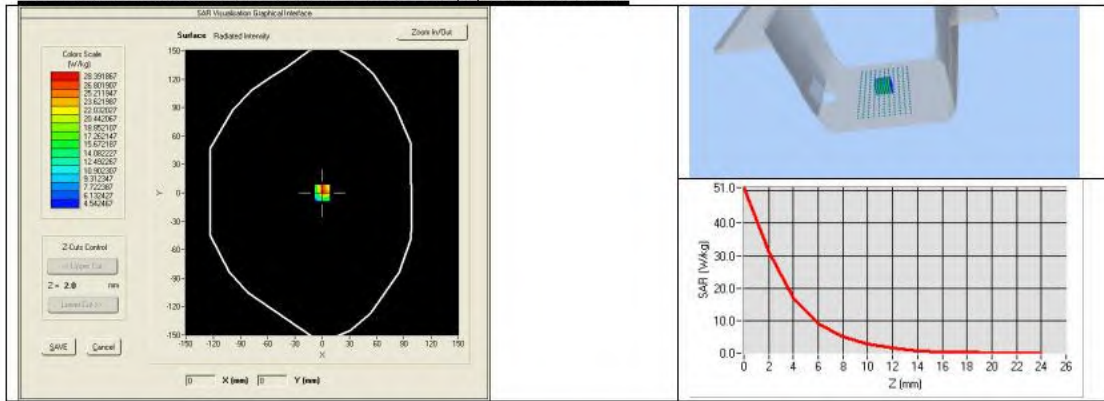

SAR MEASUREMENT PLOTS @ 5800 MHz

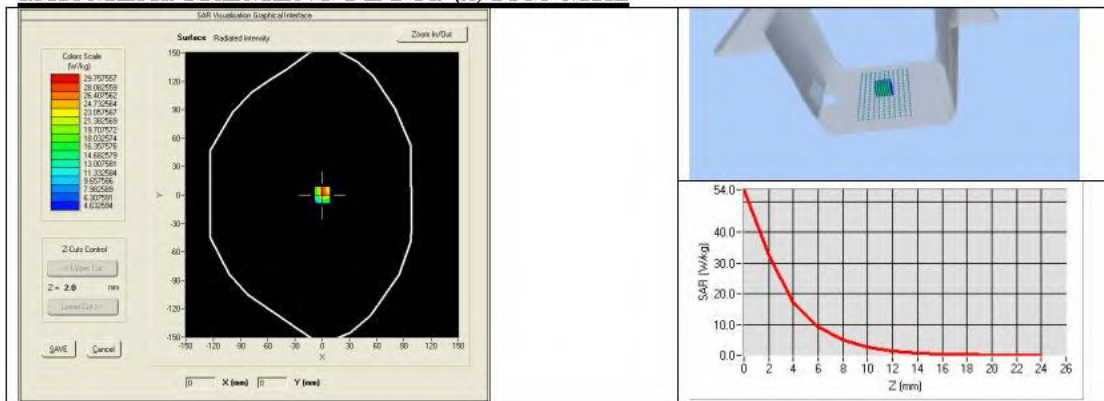

This document shall not be reproduced, except in full or in part, without the written approval of MVG. The information contained herein is to be used only for the purpose for which it is submitted and is not to be released in whole or part without written approval of MVG.

股份 g Lab







## SAR REFERENCE WAVEGUIDE CALIBRATION REPORT

Ref: ACR.273.5.18.SATU.A

股份  
g Lab

## 7.3 BODY LIQUID MEASUREMENT

| Frequency<br>MHz | Relative permittivity ( $\epsilon_r'$ ) |          | Conductivity ( $\sigma$ ) S/m |          |
|------------------|---|----------|-------------------------------|----------|
|                  | required                                | measured | required                      | measured |
| 5200             | 49.0 $\pm$ 10 %                         | PASS     | 5.30 $\pm$ 10 %               | PASS     |
| 5300             | 48.9 $\pm$ 10 %                         |          | 5.42 $\pm$ 10 %               |          |
| 5400             | 48.7 $\pm$ 10 %                         | PASS     | 5.53 $\pm$ 10 %               | PASS     |
| 5500             | 48.6 $\pm$ 10 %                         |          | 5.65 $\pm$ 10 %               |          |
| 5600             | 48.5 $\pm$ 10 %                         | PASS     | 5.77 $\pm$ 10 %               | PASS     |
| 5800             | 48.2 $\pm$ 10 %                         | PASS     | 6.00 $\pm$ 10 %               | PASS     |

## 7.4 SAR MEASUREMENT RESULT WITH BODY LIQUID

|  |  |
|--|--|
| Software                                     | OPENSAR V4   |
| Phantom                                      | SN 20/09 SAM71   |
| Probe  | SN 18/11 EPG122  |
| Liquid                                       | Body Liquid Values 5200 MHz: $\epsilon_r'$ :48.64 sigma : 5.51<br>Body Liquid Values 5400 MHz: $\epsilon_r'$ :46.52 sigma : 5.77<br>Body Liquid Values 5600 MHz: $\epsilon_r'$ :46.79 sigma : 5.77<br>Body Liquid Values 5800 MHz: $\epsilon_r'$ :47.04 sigma : 6.10 |
| Distance between dipole waveguide and liquid | 0 mm   |
| Area scan resolution                         | dx=8mm/dy=8mm  |
| Zoon Scan Resolution                         | dx=4mm/dy=4mm/dz=2mm   |
| Frequency                                    | 5200 MHz<br>5400 MHz<br>5600 MHz<br>5800 MHz   |
| Input power                                  | 20 dBm   |
| Liquid Temperature                           | 21 °C  |
| Lab Temperature                              | 21 °C  |
| Lab Humidity                                 | 45 %   |

| Frequency (MHz) | 1 g SAR (W/kg) | 10 g SAR (W/kg) |
|-----------------|----------------|-----------------|
|                 | measured       | measured        |
| 5200            | 159.09 (15.91) | 56.13 (5.61)    |
| 5400            | 164.56 (16.46) | 57.31 (5.73)    |
| 5600            | 172.25 (17.23) | 59.72 (5.97)    |
| 5800            | 177.77 (17.78) | 61.06 (6.11)    |

Page: 10/13

This document shall not be reproduced, except in full or in part, without the written approval of MVG.  
The information contained herein is to be used only for the purpose for which it is submitted and is not to be released in whole or part without written approval of MVG.

股份  
g Lab





SAR REFERENCE WAVEGUIDE CALIBRATION REPORT

Ref: ACR.273.5.18.SATU.A

股份 g Lab

BODY SAR MEASUREMENT PLOTS @ 5200 MHz

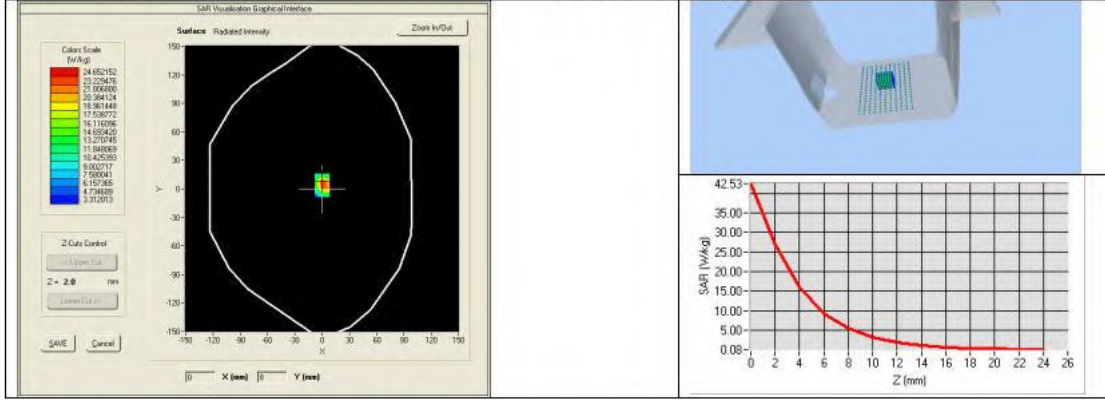

BODY SAR MEASUREMENT PLOTS @ 5400 MHz

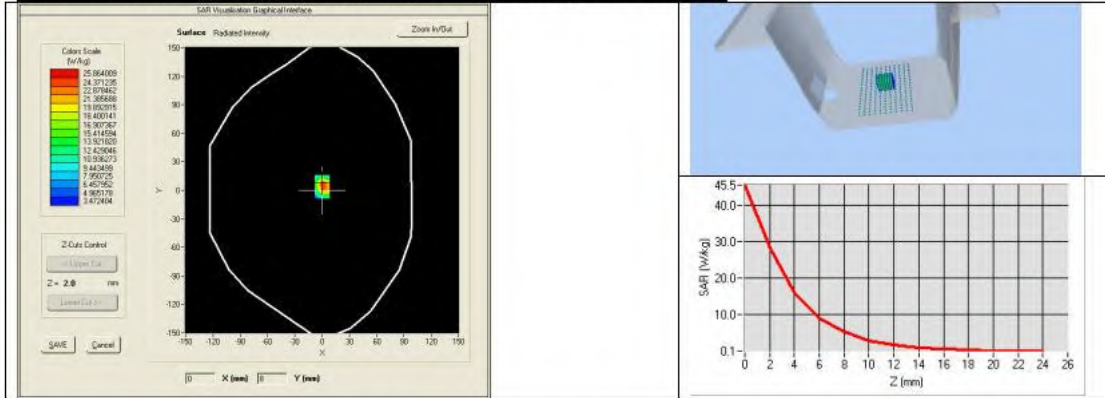

BODY SAR MEASUREMENT PLOTS @ 5600 MHz

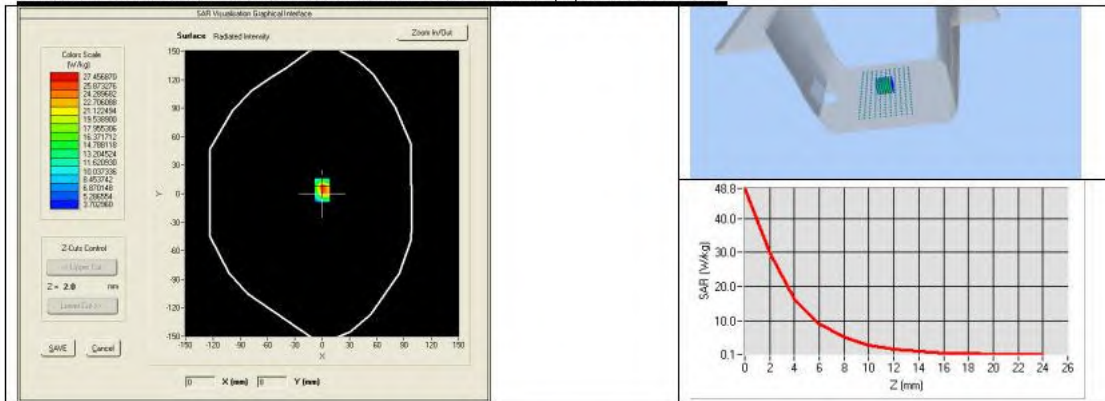

This document shall not be reproduced, except in full or in part, without the written approval of MVG. The information contained herein is to be used only for the purpose for which it is submitted and is not to be released in whole or part without written approval of MVG.

股份 g Lab





SAR REFERENCE WAVEGUIDE CALIBRATION REPORT

Ref: ACR.273.5.18.SATU.A

股份  
g Lab

**BODY SAR MEASUREMENT PLOTS @ 5800 MHz**

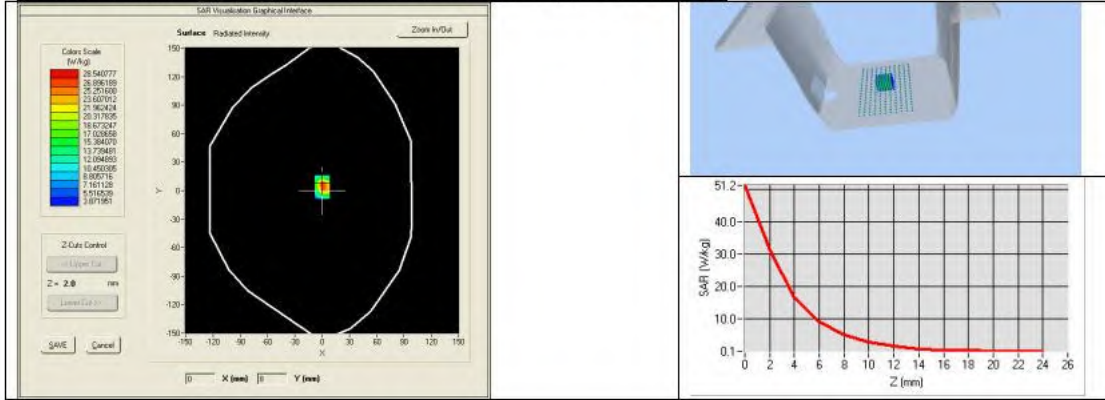

股份  
g Lab

*This document shall not be reproduced, except in full or in part, without the written approval of MVG. The information contained herein is to be used only for the purpose for which it is submitted and is not to be released in whole or part without written approval of MVG.*

股份  
g Lab





SAR REFERENCE WAVEGUIDE CALIBRATION REPORT

Ref: ACR.273.5.18.SATU.A

股份  
ig Lab

8 LIST OF EQUIPMENT

| Equipment Summary Sheet         |                      |                    |   |   |
|---------------------------------|----------------------|--------------------|---|---|
| Equipment Description           | Manufacturer / Model | Identification No. | Current Calibration Date                      | Next Calibration Date                         |
| Flat Phantom                    | MVG                  | SN-20/09-SAM71     | Validated. No cal required.                   | Validated. No cal required.                   |
| COMOSAR Test Bench              | Version 3            | NA                 | Validated. No cal required.                   | Validated. No cal required.                   |
| Network Analyzer                | Rhode & Schwarz ZVA  | SN100132           | 06/2021                                       | 06/2024                                       |
| Calipers                        | Carrera              | CALIPER-01         | 01/2020                                       | 01/2023                                       |
| Reference Probe                 | MVG                  | EPG122 SN 18/11    | 08/2021                                       | 08/2022                                       |
| Multimeter                      | Keithley 2000        | 1188656            | 01/2020                                       | 01/2023                                       |
| Signal Generator                | Agilent E4438C       | MY49070581         | 01/2020                                       | 01/2023                                       |
| Amplifier                       | Aethercomm           | SN 046             | Characterized prior to test. No cal required. | Characterized prior to test. No cal required. |
| Power Meter                     | HP E4418A            | US38261498         | 11/2020                                       | 11/2023                                       |
| Power Sensor                    | HP ECP-E26A          | US37181460         | 01/2020                                       | 01/2023                                       |
| Directional Coupler             | Narda 4216-20        | 01386              | Characterized prior to test. No cal required. | Characterized prior to test. No cal required. |
| Temperature and Humidity Sensor | Control Company      | 150798832          | 11/2020                                       | 11/2023                                       |

股份  
ig Lab

This document shall not be reproduced, except in full or in part, without the written approval of MVG. The information contained herein is to be used only for the purpose for which it is submitted and is not to be released in whole or part without written approval of MVG.

股份  
ig Lab





## 6. EUT TEST PHOTOGRAPHS

### 6.1 Photograph of liquid depth

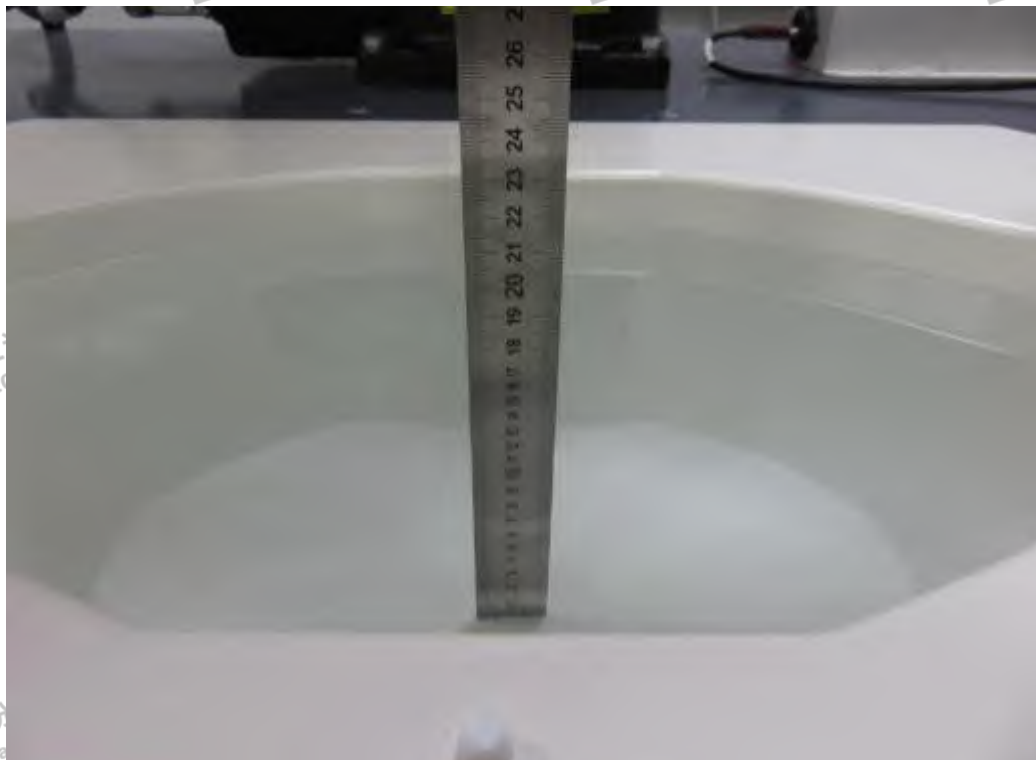

Photograph of the depth in the Body Phantom (2450MHz, 15.8cm depth)



Photograph of the depth in the Body Phantom (5200MHz, 16.2cm depth)







Photograph of the depth in the Body Phantom (5800MHz, 15.4cm depth)

立讯检测股份  
LCS Testing Lab

立讯检测股份  
LCS Testing Lab

立讯检测股份  
LCS Testing Lab

立讯检测股份  
LCS Testing Lab

立讯检测股份  
LCS Testing Lab

立讯检测股份  
LCS Testing Lab

立讯检测股份  
LCS Testing Lab

立讯检测股份  
LCS Testing Lab

立讯检测股份  
LCS Testing Lab

立讯检测股份  
LCS Testing Lab

立讯检测股份  
LCS Testing Lab





## 7. PHOTOGRAPHS OF THE TEST

Please refer to separated files for Test Setup Photos of SAR.





### 8.EUT PHOTOGRAPHS

Please refer to separated files for Test Setup Photos of SAR.

.....The End of Test Report.....

