

Model No. 5LCHG01
Original Instructions



Use Camera or QR Scanner to Scan
Or Visit: <https://5thwheel afterservice.vip>



The illustrations and function descriptions in this user manual are for illustration purposes and reference only, and the products are subject to the real product. The mentioned technical performance indicators are based on the specific experimental environment, and the actual indicators may vary depending on the setting and environment. This product needs to be used with mobile phones or other smart devices. The realization of all functions of this product requires network support, with the network fee being subject to the supplier's service rate. This product is only used to assist safety management and cannot replace other safety measures. Do not use this product for any illegal purpose. Some services are provided and supported by third parties, which may change at any time. Invanti does not provide any guarantee for third-party services. Please read the terms of the third-party service and privacy policy carefully before use.

The text and logo of 5TH WHEEL are trademarks or registered trademarks of enterprises affiliated with Invanti. Other company, product or service names mentioned may be trademarks or registered trademarks of their respective owners.

© 2022 Invanti (Beijing) Technology Co., Ltd all rights reserved.

User's Manual of 5th Wheel Scooter G1

V1.0

The picture is for reference only.
Before using the product, please read this manual.
IMPORTANT! Read carefully and keep for future reference.

Contents

1.Safety Instructions	2
2.Introduction to Functions	9
3.Product Display	11
4.Scooter Assembly	12
5.Unfolding/Folding/Carrying	13
6.Riding and Parking	16
7.Control System	17
8.Indication Description	20
9.About Charging	22
10.About the Battery and Charger	22
11.App Descriptions	24
12.Maintenance	26
13.Common Problems and Solutions	27
14.Parameter Configuration	28
15.Authentication	29

* Please read and know the instructions described in the user manual carefully before using the electric scooter and keep it for future reference.

Welcome

Thank you for choosing the 5th Wheel Scooter G1 (hereinafter referred to as G1). Enjoy the pleasure brought by G1



1 Safety Instructions

Note: Before using this product, please carefully read the following important safety information.

1. This electric scooter can be used by one adult only. Never carry others.



2. Wear safety helmet and other protective equipment while using this product.

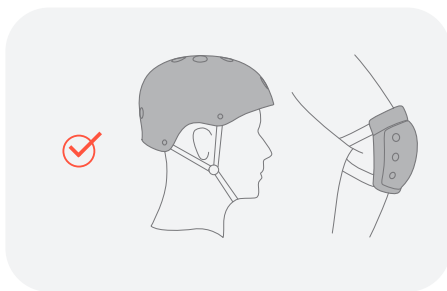

3. Never ride this product in an unsafe or illegal place.



4. Please practice in an open area (not on lanes) first and use this product until you are skilled in operation.

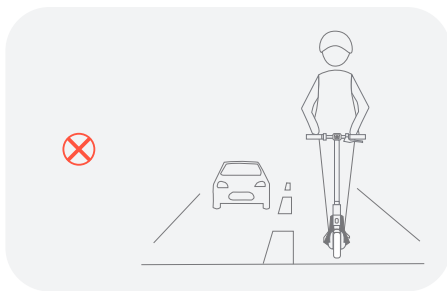

5. Do not make dangerous actions or ride with one hand only. Keep your feet on the scooter.

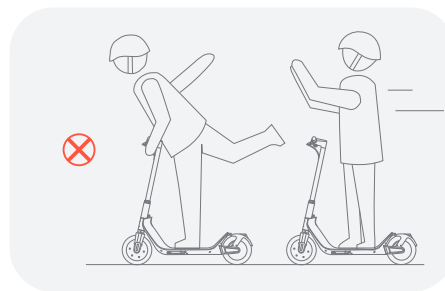

6. Avoid obstacle jumps and anticipate and adapt your trajectory and speed to those of a pedestrian before crossing these obstacles. Meanwhile, get out of the vehicle when these obstacles become dangerous due to their shape, height or slippage. Do not try to directly pass steps are higher than 3 cm.

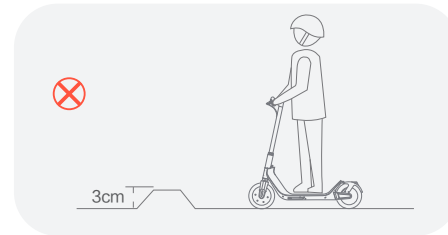

7. For your safety, please control the speed to be less than 25 km/h. Avoid using it at night as much as possible. If you use this product at night, turn on the headlight and control the speed to 15 km/h or less.



8. Do not use this product at the ambient temperature below -5°C. Temperature range of charging and cycling environment: 10°C-40°C.



9. In the event of bumps or poor road conditions, please use this scooter slowly or get off the scooter and push it forward.

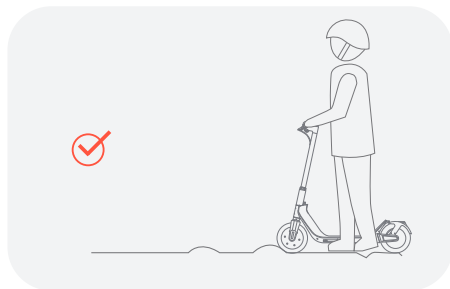

10. Do not use this product on an oily or icy surface.

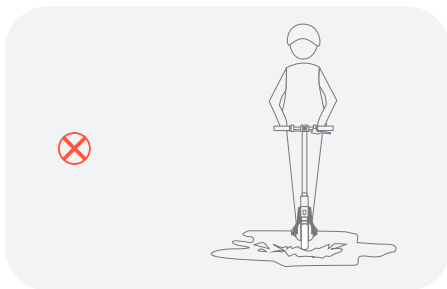

11. To avoid damage caused by water to its electrical parts, Please Do not immerse this product at a depth of more than 4 cm in water.



12. Avoid using this product as much as possible in bad weather such as rain, snow and wind, to prevent unnecessary damage caused by insignificant factors.

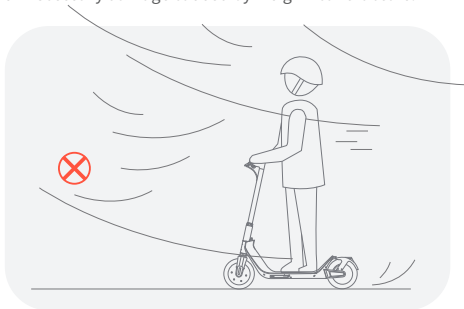

13. Use this product in accordance with relevant instructions in this manual. Do not use this product beyond the allowable load range.



14. Avoid using or keeping this product at high or extremely low temperatures, or keeping this product together with flammables.



15. The scooter is a special riding product. Please ride it on smooth roads without pits.



16. Do not any load attached to the handlebar which will affect the stability of the vehicle.



17. Engage the kickstand when the vehicle is not in use; Flip up the kickstand before use; Do not park the vehicle on the slope.

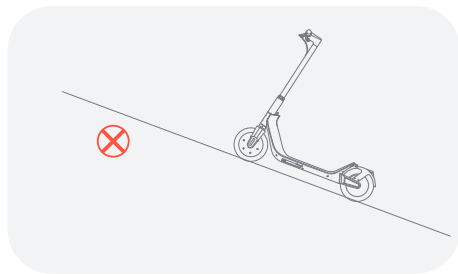

19. Braking performance and friction between the tire and road deteriorates in wet conditions, so it is harder to control the speed and easier to lose control. Slow down and brake early when it is raining.



18. The minimum height of the user is 1.4m, while the maximum height is no more than 2.2m; the maximum age of the user is 70 years old, while the minimum age is no less than 13 years old.

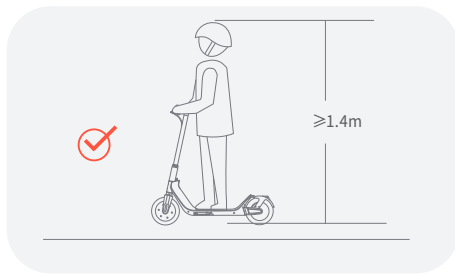

20. WARNING Keep plastic covering away from children to avoid suffocation.

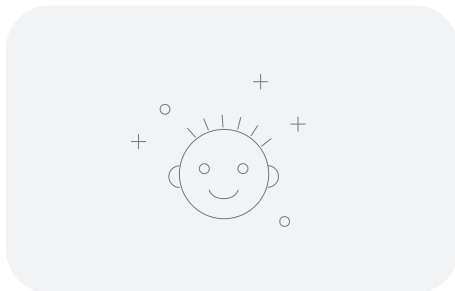

21. The user shall take the time to learn the basics of the practice to avoid any serious accident that can take place in the first month.

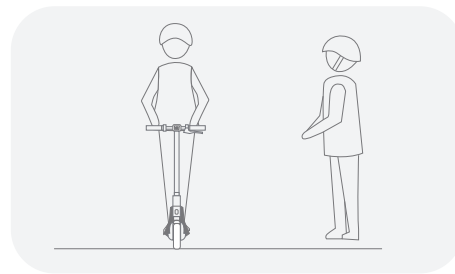

23. Cross the protected passages while walking. In all cases, take care of yourself and others.

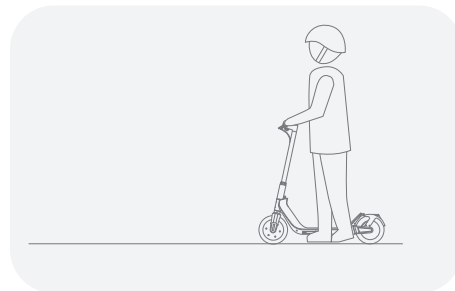

22. Notify your presence when approaching a pedestrian or cyclist when you are not seen or heard. Avoid high traffic areas or overcrowded areas.

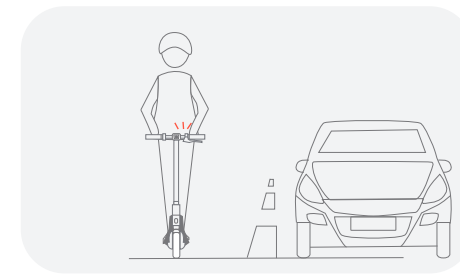

24. Do not divert the use of the vehicle. This vehicle is not intended for acrobatic use.

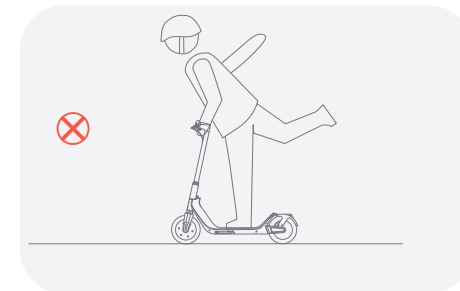

25. Caution, the brake may become hot in use. Do not touch after use.

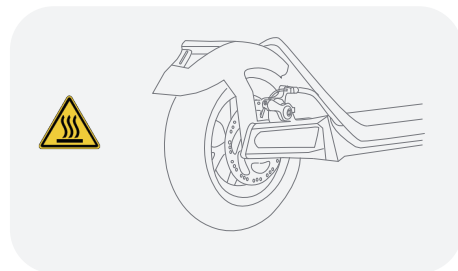

26. Eliminate any sharp edges caused by use. Do not modify or transform the vehicle, including the steering tube and sleeve, stem, folding mechanism and rear brake.



27. The user has the obligation to always wear shoes when riding.

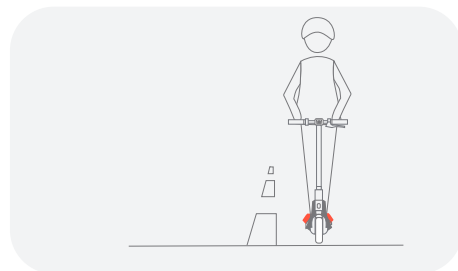

28. In any case, anticipate your trajectory and your speed while respecting the code of the road, the code of the sidewalk and the most vulnerable. If any, local special laws and regulations should be observed during riding of this product.

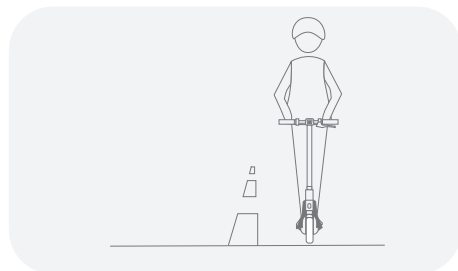

2 Introduction to Functions

1. Product Overview

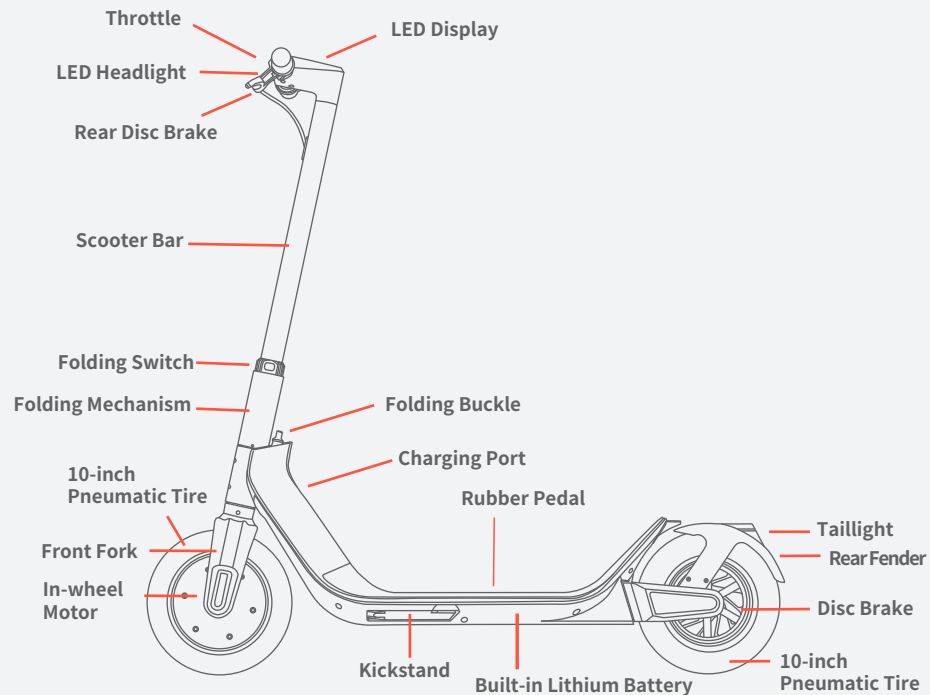

*The accessories and any additional items which are not approved by the manufacturer shall not be used.

Accessories



Manual



Screw *2

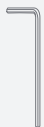

Screwdriver



Commissioning tool kit

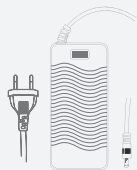

Power adapter

Note: Please check out all the items in the package carefully. If anything is missing or damaged, please contact email: 5thwheel-de@afterservice.vip

Product Contents	Quantity
User Manual	1
Screws	2
Fastening Tool	1
Tool Kit	1
Power Adapter	1

3 Product Display

Unfolded status



Folded status



4 Scooter Assembly

1. Unfold the folding mechanism of G1 and put down the kickstand.

Unfold G1 and fix the folding mechanism.
(Refer to "Folding and Carrying"
for retails of unfolding.)

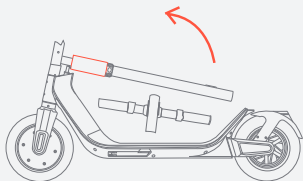

2. Insert the handlebar into the scooter bar.



Pull out the cables placed
in the scooter bar and the
handlebar.

3. Use the tools included in the package to tighten the screws.



4. After assembly, check whether the power switch can work normally.

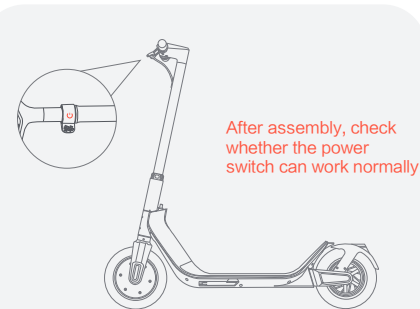

5 Unfolding/Folding/Carrying

1. Unfolding Operations

1. Pull the cylindrical folding switch outward (to the right side).

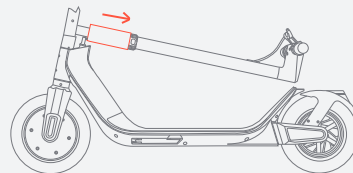

2. When pulling the folding switch, pull up the scooter bar.

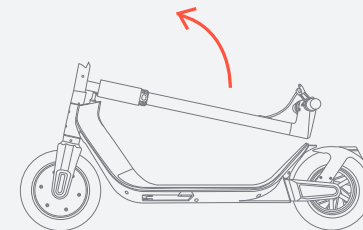

3. When pulling the scooter bar to the correct place, push the folding switch down to the bottom to fix it.



4. Rotate the folding switch to the OFF position and G1 is now unfolded completely.



2. Folding Operations

Note: For safety, it is recommended to fold the scooter after it is shut down.

1. Rotate the folding switch to the ON position.

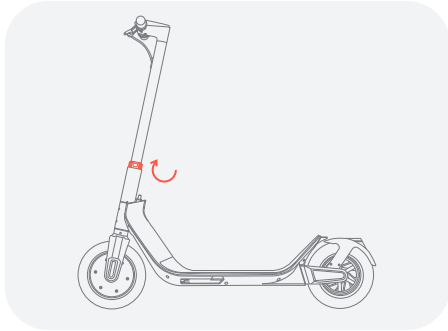

2. Pull the folding switch upward.



3. Put down the scooter bar.

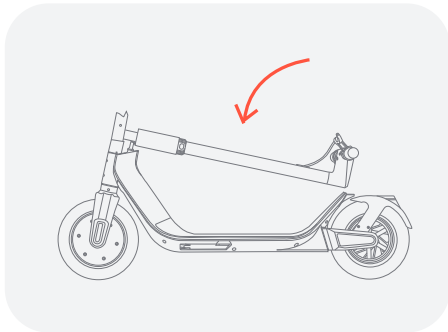

4. Pull the folding switch outward and lock it by using the buckle to finish folding it.

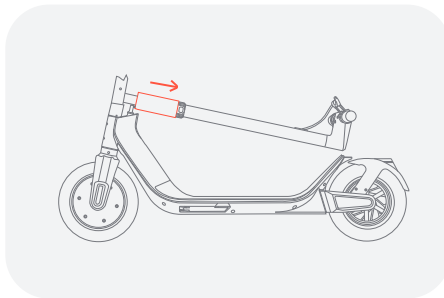

3. About Carrying

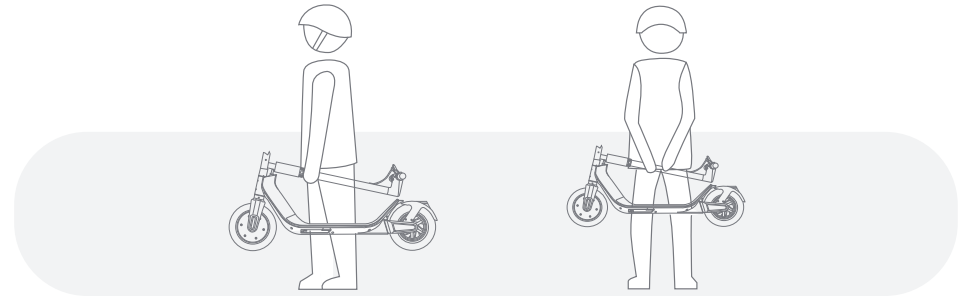

After folding, you can carry the scooter with one or two hands.

6 Riding and Parking

Preparation for riding

1. Select an appropriate riding place.
2. Unfold the scooter according to the unfolding instructions and wear protective equipment.
3. It is necessary to check that the steering system is correctly adjusted, that all connection elements (such as a folding system) are correctly tightened and not broken, and that the brakes and wheels are in good condition.

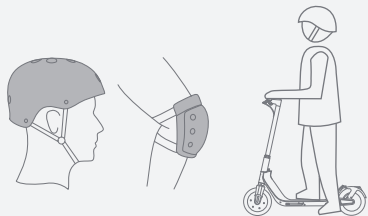

Riding

1. Press the power button to turn on the scooter.
2. Put one foot on the footboard and the other foot on the ground.
3. Make the scooter body slide forwards to 3km/h and gently press the right thumb accelerator. The scooter will slowly run forwards. When the scooter is running steadily, put the other foot onto the footboard. The larger holding angle of the right thumb accelerator, the higher the speed.

Note: For the riding safety, G1 has a non-zero start mode. The accelerator cannot be enabled until the body slides forwards for a certain distance.

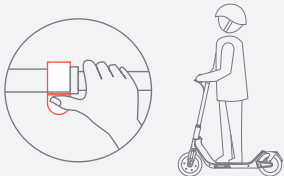

Stop

1. Under normal circumstances, if you hold the left brake lever, the motor will be immediately powered off and subject to braking. The greater the holding force, the greater the braking force.
2. Under emergency conditions, you can step on the rear brake to simultaneously enable the electromagnetic brake of the front wheel and friction brake of the rear wheel.

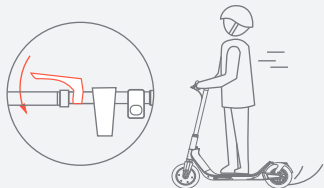

7 Control System

- (A) Power Button
- (B) Gear Indicator
- (C) Speed Control
- (D) Brake Lever
- (E) Instrument Display
- (F) Disc brake

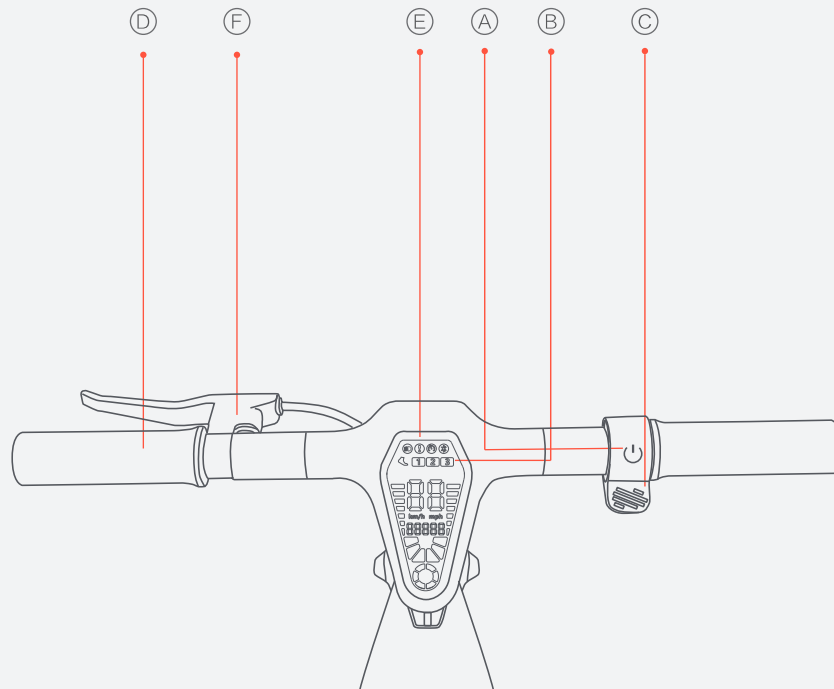

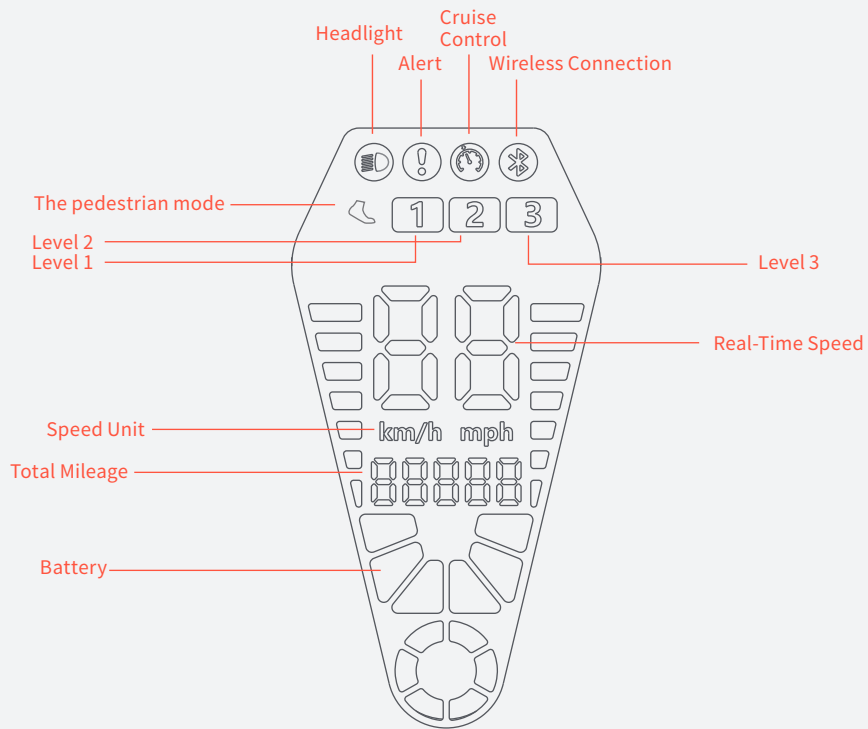

Power Switch

Short press the Power switch for 1 second to turn on the scooter, and long press the Power switch for 3 seconds to turn it off.

Gear Setting

Press the power button twice quickly to switch the gear. The gear can be set to Level 1 (max. 6 km/h, The pedestrian mode), Level 2 (max. 16 km/h), and Level 3 (max. 25km/h).

Speed Control

When riding the scooter at a speed faster than 3km/h (1.86 mph), the throttle will get started and take effect. By pressing the throttle, the user can control the riding speed. (Speed Range: 1-25km/h / 0.62-15.53 mph)

Brake Control

Hold the left brake handle. The greater the pressure, the greater the braking force.

LED Headlight Switch

After switching on the scooter, click the LED headlight switch to turn it on.

Emergency Braking

Under normal circumstances, do not use emergency braking vigorously during high-speed driving, so as to avoid the riding risk or damage to the rear wheel. The company is not responsible for the damage.

Cruise Control

The constant speed cruise of G1 is not initially set. If cruise control is needed, launch the App and set the cruise time for a constant speed. When it runs at a constant speed and reaches the set cruise time, it will automatically switch on the cruise control function. When the constant speed cruise begins, release the throttle, and the scooter will automatically move forward at a constant speed. To cancel the cruise control function, just press the left brake and it will be canceled. When the riding speed reaches the set cruise speed again, the constant speed cruise can be restarted.

8 Indication Description

Automatic Cruise Indication

Switch On	Switch Off
If the auto cruise is switched on, the indicator remains on.	If the auto cruise is switched off, the indicator is off.

LED Headlight Status Indication

Switch On	Switch Off
If the LED headlight is switched on, the indicator remains on.	If the LED headlight is switched off, the indicator is off.

3 Gears Indication

Gear 1	Gear2	Gear 3
The Gear 1 is enabled.	The Gear 2 is enabled.	The Gear 3 is enabled.

Brief Use Instructions

When the scooter is powered off, press the Power switch briefly to turn it on. When the scooter is operating, long press the Power switch to turn it off. During riding the scooter, press the LED headlight switch briefly to turn on the LED headlight and press again to turn it off. (The LED headlight switches circularly from ON to OFF to ON.) During riding the scooter, double press the Power switch to switch gears, with the setting range being switched from Gear 1, Gear 2 to Gear 3. The scooter will save the gear selected by the last time before shutdown.

If there is anything abnormal about the scooter, the warning indicator will flash, with the flashing value E1-E6 displayed.

Errors	Codes	Solutions	
Communication Fault	E1	Please check whether the taillight is on. If it is off, it means that the power supply is insufficient. Please replace the controller or the LED display. If it is on, please check whether the connecting wire between the controller and the LED display is open-circuit.	
Brake Failure	E2	Please check whether the brake is pressed.	Press and release the brake to reset the brake. If not, please check whether the connecting wire between the brake and the LED display is short-circuited or open-circuit. Replace the brake handle. If it is open-circuit or short-circuited, please replace the connecting wire.
Throttle Failure	E3	Please check whether the throttle is pressed.	Press and release the throttle to reset the throttle. If not, please check whether the connecting wire between the throttle and the LED display is short-circuited or open-circuit. Replace the throttle. If it is open-circuit or short-circuited, replace the connecting wire.
Motor Fault	E4	Check whether the motor and controller wire is connected correctly.	If it is not connected correctly, please adjust and connect the motor and the controller correctly. If it is connected correctly, please disconnect the connecting wire and measure whether the internal resistance between the three-phase wires of the motor is within a reasonable range, generally within 0.1Ω-1Ω. If it exceeds the range, the motor needs to be replaced.
Controller Failure	E5	If the controller is damaged, please replace the controller.	
Overheated Motor	E6	Check whether the motor temperature is too high.	If the motor temperature is too high, please wait for the motor to cool to the appropriate working temperature. If the motor temperature is normal, check whether the connecting wire of the controller is short-circuited. If it is short-circuited, please replace the connecting wire.

9 About Charging

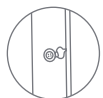
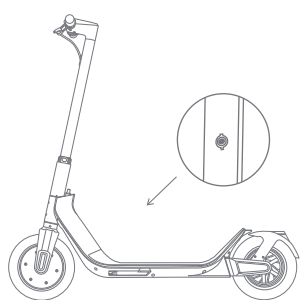

Remove the rubber protective cover of the charging port.

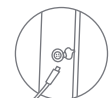

Connect the charger.



After charging, push the rubber protective cover back in

- 1.Remove the rubber protective cover, and insert the charger connector into the charging port of the body.
- 2.Insert the power plug of the charger into the power socket.
- 3.When the charger indicator is red, it indicates that the battery is being charged. When the charger indicator turns green, it indicates that the battery has been fully charged.
- 4.Requirement to power-off the vehicle during charging, or into a certain non-operational mode.

10 About the Battery and Charger

Each G1 electric scooter is equipped with a dedicated lithium battery and smart charger. Both the scooter and its accessories have product identification numbers. It is forbidden to use the chargers of other brands. The chargers provided by the company must not be used for other purposes. The company is not responsible for the resultant damage to the battery or charger.

Battery

The lithium battery provided by the company can be recharged for at least 800 times, and more than 1,000 times under normal circumstances. Please charge full battery for the first time before using it. The battery can be charged at any time, and there is no any damage to charge it frequently. Meanwhile, please don't forget to charge it per 3 months if you don't use it for a long term.

Charger

The dedicated charger provided by the company has a function of charging protection. When the battery is 100% charged, the charger will be powered off automatically. The charging time is about 4-5 hours. Damage to the battery arising from water, collision and other abnormal factors is excluded from the warranty policy. Temperature range of charging and cycling environment:10°C-40°C.

搭配的充电器信息 (厂家、型号、参数)。

Charging instructions

1. Open the rubber and insert the plug into the hole;
2. Insert another plug of the charger into the electric outlet;
3. When the indicator lamp is red, it shows the battery being charged; When the lamp turns green, the battery is finished charging.
4. Please shut down and keep away from water before charging.
5. Only use the specified charger for charging.
6. Warning: Please be careful not to get electric shock.

Kinetic energy recovery

Press the brake in the running process to enable the kinetic energy recovery system and convert part of kinetic energy into electrical energy to be stored and used. The kinetic energy recovery system can enhance the experience of emergency braking. At the same time, the recovered kinetic energy can help increase the endurance. Changes in the power are displayed simultaneously.

11 App Descriptions

5TH WHEEL App Manual Operation

No manual operation is required in case of registering an account of 5TH WHEEL and completing the minimalist connection. The device card will be displayed on the homepage of the 5TH WHEEL App.

1. Please scan the QR code with your mobile phone, or search for “5thWheel” in the App market to download and install the App.



5thWheel App

❗ In the event that you have installed 5thWheel App, please make sure that it is the latest version.

2. Open the 5thWheel App, and please register/log in to the 5thWheel account according to the App guidelines for the first use. And then, enter the App homepage, click “+” in the upper right corner and “Add Device”. After that, move your mobile phone close to the device, and the App will automatically scan the device.



❗ Please keep your mobile phone Bluetooth and device in the state of “On”, and try again in case of failure to scan the device.

3. After scanning the device successfully, please click “Connect” to successfully add the device as prompted by the interface.



❗ After adding the device successfully, the device will be displayed on the homepage of 5thWheelApp. And then, click the device card to enter the control interface to control the device.

4. If you encounter any problems when using the product, please feel free to contact us through the following methods or scan the QR code to get a quick response and a satisfactory solution.



❗ Use Camera or QR Scanner to Scan Or Visit: <https://5thwheel.afterservice.vip>

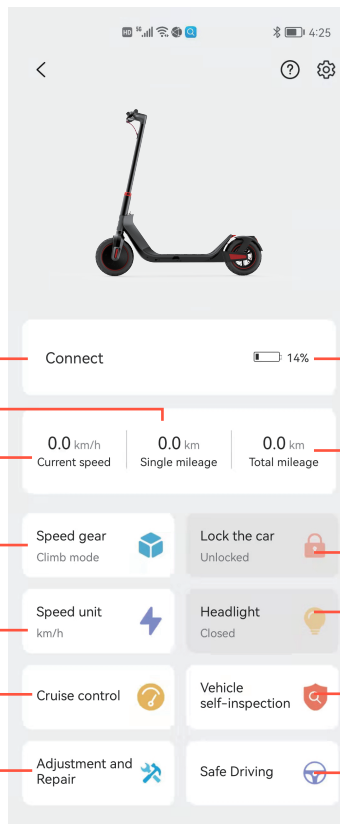

- connect — Connect — Battery indicator (14%)
- Single mileage — 0.0 km
- Current speed — 0.0 km/h (Current speed) | 0.0 km (Single mileage) | 0.0 km (Total mileage) — Total mileage
- Speed gear — Speed gear (Climb mode) — Lock the car (Unlocked)
- Speed unit — Speed unit (km/h) — Headlight (Closed)
- Cruise control — Cruise control — Vehicle self-inspection
- Adjustment and Repair — Adjustment and Repair — Safe Driving

Special note: about the locking function,
It can only ensure that the vehicle cannot run normally
Due to the light weight of the whole vehicle and
The whole vehicle is composed of mechanical parts
it can be removed with corresponding tools
To ensure that the vehicle is not stolen,
Please park your vehicle in sight
Enclosed or added machinery and Fixtures

*The actual content shall be subject to the app display interface

12 Maintenance

Lubrication



For maintenance, add a small amount of white grease or lubricant to the folded part once every six months. Check the scooter once every three months for screw loosening. Tighten the loose screw.

Battery



When you get the electric scooter for the first time, please fully charge the battery before using the scooter. The battery can be charged at any time to ensure the power supply. It will not be damaged during charging. When not in use, the battery needs to be charged once every three months.

*Laboratory data

Storage and daily maintenance



Avoid leaving scooter under direct sunlight or in severely humid places for a long time.

Keep the scooter clean.

Regularly check the tightening of the various bolted elements, in particular the wheel axles, the folding system, the steering system and the brake shaft.

Cleaning Recommendations



If you see stains on the scooter's body, wipe them off with a damp cloth. If the stains won't scrub off, put on some toothpaste, and brush them with a toothbrush, then wipe them off with a damp cloth. Do not clean the scooter with alcohol, gasoline, kerosene or other corrosive and volatile chemical solvents to prevent dire damage. Do not wash the scooter with a high-pressure water spray. During cleaning, make sure that the scooter's turned off, the charging cable is unplugged, and the rubber flap is closed as water leakage may result in electric shock or other major problems.

Routine Inspection



1. Before riding, please confirm the folding mechanism is locked;
2. Please check whether the tires are badly worn. Please contact the local authorized dealer if they need to be replaced;
3. Please check whether the tire pressure is at the standard value. If the tire pressure is too low, please inflate the tires immediately;
4. Please check whether the wear condition of the brake pad affects the use of the brake system. If so, please contact the local authorized dealer to deal with the problem;
5. The screws used in this product are self-tightened screws. Please note that the effect may be gone after several times of tightening.
6. WARNING – Risk of Fire and Electric Shock – No User Serviceable Parts.
7. Prolonged Exposure to UV Rays, Rain and the Elements May Damage the Enclosure Materials, Store Indoors When Not in Use.

13 Common Problems and Solutions

If there is any problem with the scooter, please try to solve it in the following ways.

1. The display screen is black.

Possible Causes: The exposure time in the sun is too long.

Solutions: Please place the scooter in a dark environment for a period of time and it will return to normal.

2. The value is inconsistent with the actual value.

Possible Causes: The parameter setting is incorrect or missing.

Solutions: Long press the Power switch to shut down the scooter, and then short press the Power switch to restart it.

3. The digital display is dim.

Possible Causes: The battery connection is loose, or there is no battery power left.

Solutions: Turn off the scooter and restart it. If the problem remains, please contact the customer service via <https://5thwheel-de.afterservice.vip>

4. The product cannot work normally.

1. Please make sure that it is powered on.
2. Check whether there is battery power left by viewing the display screen.
3. Check whether the left brake and rear brake are in place.
4. Check whether all ports and power cables are connected accurately.
5. If all the above steps are checked and the product still cannot work normally, please contact us via <https://5thwheel-de.afterservice.vip>

14 Parameter Configuration

Parameter	Product name	5th Wheel Scooter G1
	Model	5LCHG01
Size	Upright: L x W x H	Approx.47×23×45 inches
	Folded: L x W x H	Approx.47×23×21 inches
Weight	Net weight	Approx. 44lbs
Status	Max Load	220lbs
Main parameters	Max Speed	About 15.5mph
	Full-battery endurance	21-24miles (depending on the environment, angle, speed, driving habits and other factors)
	Max Incline	Approx.14%
	Scope of application	Smooth road surface, with protrusions of less than 2 cm and depressions of less than 3 cm
	Tyre	10-inch pneumatic tyre
	Brake system	disc brake
	LED display	Speed, kilometers, gear
	Lighting system	LED high-brightness headlight
	Motor power	500W
Charging parameters	Adapter Rated input voltage	100V-240VAC 50/60Hz
	Lithium battery	36V-10AH
	Charging time	6-7h

Wireless parameters	Wireless frequency range	2400~2483.5 MHz
	Wireless maximum output power	1dBm

15 Authentication

Applicable model: G1

The product has passed the ANSI/CAN /UL-2272 certification of the CSA.
The battery complies with the UN/DOT 38.3.

According to the Federal Communications Commission (FCC) Compliance Statement as follows:

The product complies with part 15 of the FCC rules, and the operation must meet the following two conditions: (1) the product should not cause harmful interference, and (2) the product must accept any received interference, including interference that may lead to accidental operation. Any change or modification not expressly approved by the responsible party may make void the user' s right to operate the product.



The EU Compliance Statement is as follows:

WEEE needs to properly dispose of and recycle the product. This sign indicates that the product should not be disposed of together with other domestic waste throughout the EU. Therefore, in order to prevent possible harm of uncontrolled waste treatment to the natural environment or human health, it is necessary to recycle it and promote the sustainable reuse of material resources. To recycle the used product, use the return and collection system or contact the retailer who can use the product for environmentally safe recycling.



EU Battery Recycling Information:

Batteries or battery compartments are marked in accordance with the European Directive 2006/66/EC and the amendment 2013/56/EU on batteries and accumulator cells and scrap batteries and accumulator cells. The directive applies to the recycling framework of waste batteries and accumulator cells throughout the EU. The label on the battery indicates that the battery should not be discarded, but recycled at the end of its service life according to the directive.

According to the European Directive 2006/66/EC and the amendment 2013/56/EU, batteries and accumulator cells are labeled to indicate that they will be collected separately and recycled at the end of their service life. The label on the battery may also contain the chemical symbols of the relevant metals in the battery (Pb, Hg and Cd). Users should not dispose of batteries and accumulator cells as garbage, but use the collection framework available to customers to recycle and dispose of batteries and accumulator cells. With the engagement of users, it is important to minimize any potential impact of batteries and accumulator cells on the environment and human health due to the presence of potentially hazardous substances.

Before placing electrical and electronic equipment (EEE) into a waste collection stream or waste collection facility, users of equipment containing batteries and/or accumulator cells must remove these batteries and accumulator cells for separate collection.

Restriction of Hazardous Substances in Electrical and Electronic Equipment (RoHS) Directive.

The products and parts (cables, wires, etc.) of Invanti (Beijing) Technology Co., Ltd comply with the requirements of directive 2011/65/EU on restricting the use of certain hazardous substances in electrical and electronic equipment ("RoHS recasting" or "RoHS 2")

© Trademark and Legal Statements

5TH WHEEL is a registered trademark of Invanti (Beijing) Technology Co., Ltd (hereinafter referred to as "Invanti"), which is authorized to be used by Solowii (Beijing) Technology Development Co., Ltd. Android and Google Play are trademarks of Google Inc. and the App Store is the service mark of Apple Inc. Their respective owners reserve the trademark rights mentioned in this user manual.

The products involved in the registered trademark of 5TH WHEEL are protected by relevant patent laws. For relevant patent information, please visit the website: <http://www.invanti.com>.

In this user manual, we make our utmost to describe all the instructions and functions of the G1 electric scooter. With constant updates and iteration, the G1 electric scooter received may be slightly different from the product features shown in this manual. For more information, please visit the Apple App Store (iOS) to download the App.

Please note that Invanti has developed products with many functions and different models of products, and some of the functions mentioned here may not be applicable to the product or equipment received. The manufacturer reserves the right to change the design and function of the G1 electric scooter and documents without notice.

2021 Invanti (Beijing) Technology Co., Ltd all rights reserved.

Contact Us

If you encounter any problems when using the product, please feel free to contact us through the following methods or scan the QR code to get a quick response and a satisfactory solution.

Amazon Platform: "Contact Seller"
Email Address: 5thwheel@afterservice.vip

Get 24/7 Customer Service



Use Camera or QR Scanner to Scan

Or Visit: <https://5thwheel.afterservice.vip>

This device complies with Part 15 of the FCC Rules. Operation is subject to the following two conditions: (1) this device may not cause harmful interference, and (2) this device must accept any interference received, including interference that may cause undesired operation

NOTE: This equipment has been tested and found to comply with the limits for a Class B digital device, pursuant to Part 15 of the FCC Rules. These limits are designed to provide reasonable protection against harmful interference in a residential installation. This equipment generates, uses and can radiate radio frequency energy and, if not installed and used in accordance with the instructions, may cause harmful interference to radio communications. However, there is no guarantee that interference will not occur in a particular installation.

If this equipment does cause harmful interference to radio or television reception, which can be determined by turning the equipment off and on, the user is encouraged to try to correct the interference by one or more of the following measures:

- Reorient or relocate the receiving antenna.
- Increase the separation between the equipment and receiver.
- Connect the equipment into an outlet on a circuit different from that to which the receiver is connected.
- Consult the dealer or an experienced radio/TV technician for help.

Warning: changes or modifications not expressly approved by the party responsible for compliance could void the user's authority to operate the equipment