

TEST REPORT

Applicant: Blackshark Technologies (Nanchang) Co., Ltd.
Address: Room 815-1, 8th floor, Block A, Huajiang Building,
No.1 Tsinghua Science Park, Nanchang City, China
Equipment Type: 5G Digital Mobile Phone
Model Name: SHARK PAR-H0
Brand Name: BLACK SHARK
FCC ID: 2A2ZHPAR-H0
Test Standard: 47 CFR Part 15 Subpart E
(refer section 3.1)
Test Date: Jan. 24, 2022
Date of Issue: Mar. 14, 2022

ISSUED BY:

Shenzhen BALUN Technology Co., Ltd.

Tested by: Julie Zhu

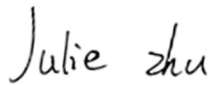

Checked by: Ye Hongji



Approved by: Liao Jianming
(Technical Director)



| Revision History | | |
|-------------------------|----------------------|----------------------|
| Version | Issue Date | Revisions |
| <u>Rev. 01</u> | <u>Mar. 14, 2022</u> | <u>Initial Issue</u> |

TABLE OF CONTENTS

| | | |
|---------|--|----|
| 1 | Administrative Data (GENERAL INFORMATION)..... | 4 |
| 1.1 | Identification of the Testing Laboratory | 4 |
| 1.2 | Identification of the Responsible Testing Location | 4 |
| 2 | PRODUCT INFORMATION | 5 |
| 2.1 | Applicant Information | 5 |
| 2.2 | Manufacturer Information..... | 5 |
| 2.3 | Factory Information..... | 5 |
| 2.4 | General Description for Equipment under Test (EUT)..... | 5 |
| 2.5 | Technical Information | 6 |
| 3 | SUMMARY OF TEST RESULTS | 7 |
| 3.1 | Test Standards | 7 |
| 3.2 | Test Verdict | 7 |
| 3.3 | Measurement Uncertainty..... | 7 |
| 4 | GENERAL TEST CONFIGURATIONS | 8 |
| 4.1 | Test Environments..... | 8 |
| 4.2 | Test Equipment List..... | 8 |
| 4.3 | Test Software List..... | 10 |
| 4.4 | Description of Test Setup | 11 |
| 5 | TEST ITEMS | 12 |
| 5.1 | DFS | 12 |
| ANNEX A | TEST RESULT | 22 |
| A.1 | CHANNEL CLOSING TRANSMISSION AND CHANNEL MOVE TIME | 22 |
| A.2 | NON- OCCUPANCY PERIOD | 26 |
| ANNEX B | TEST SETUP PHOTOS | 28 |

| | | |
|---------|--------------------------|----|
| ANNEX C | EUT EXTERNAL PHOTOS..... | 28 |
| ANNEX D | EUT INTERNAL PHOTOS..... | 28 |

1 Administrative Data (GENERAL INFORMATION)

1.1 Identification of the Testing Laboratory

| | |
|--------------|---|
| Company Name | Shenzhen BALUN Technology Co., Ltd. |
| Address | Block B, 1/F, Baisha Science and Technology Park Shahe Xi Road, Nanshan District Shenzhen, Guangdong Province, People's Republic of China |
| Phone Number | +86 755 6685 0100 |

1.2 Identification of the Responsible Testing Location

| | |
|---------------|--|
| Test Location | Shenzhen BALUN Technology Co., Ltd. |
| Address | Block B, 1/F, Baisha Science and Technology Park Shahe Xi Road, Nanshan District Shenzhen, Guangdong Province, People's Republic of China |
| Description | All measurement facilities used to collect the measurement data are located at Block B, 1/F, Baisha Science and Technology Park Shahe Xi Road, Nanshan District Shenzhen, Guangdong Province, People's Republic of China |

2 PRODUCT INFORMATION

2.1 Applicant Information

| | |
|-----------|---|
| Applicant | Blackshark Technologies (Nanchang) Co., Ltd. |
| Address | Room 815-1, 8th floor, Block A, Huajiang Building, No.1 Tsinghua Science Park, Nanchang City, China |

2.2 Manufacturer Information

| | |
|--------------|---|
| Manufacturer | Blackshark Technologies (Nanchang) Co., Ltd. |
| Address | Room 815-1, 8th floor, Block A, Huajiang Building, No.1 Tsinghua Science Park, Nanchang City, China |

2.3 Factory Information

| | |
|---------|-----|
| Factory | N/A |
| Address | N/A |

2.4 General Description for Equipment under Test (EUT)

| | |
|---|-------------------------|
| EUT Name | 5G Digital Mobile Phone |
| Model Name Under Test | SHARK PAR-H0 |
| Series Model Name | N/A |
| Description of Model name differentiation | N/A |
| Hardware Version | N/A |
| Software Version | N/A |
| Dimensions (Approx.) | N/A |
| Weight (Approx.) | N/A |

2.5 Technical Information

| | |
|-----------------------------------|---|
| Network and Wireless connectivity | 2G Network GSM/GPRS/EDGE 850/1900 MHz 3G Network WCDMA/HSDPA/HSUPA Band 2/4/5 EVDO Rel. 0/Rev. A Band Class 0 4G Network FDD LTE Band 2/4/5/7/12/17/26 TDD LTE Band 38/41 LTE CA Uplink (UL): CA_7C 5G Network SA: NR n5/n7/n41/n77/n78 NSA(EN-DC): DC_5A_n78A, DC_7A_n78A, DC_38A_n78A Bluetooth (BR+EDR+BLE) 2.4G WIFI 802.11b, 802.11g, 802.11n(HT20/40), 802.11ax(HE20/40) 5G WIFI 802.11a, 802.11n(HT20/40), 802.11ac(VHT20/40/80) and 802.11ax(HE20/40/80) U-NII-1/2A/2C/3, GPS, GLONASS, Beidou, Galileo, NFC |
|-----------------------------------|---|

The requirement for the following technical information of the EUT was tested in this report:

| | | |
|--|--|--|
| Frequency Range | 5250 MHz to 5350 MHz, 5470 MHz to 5725 MHz | |
| Product Type | <input type="checkbox"/> Mobile <input checked="" type="checkbox"/> Portable <input type="checkbox"/> Fix Location | |
| Maximum Output Power | 5250 MHz to 5350 MHz: 16.89dBm 5470 MHz to 5725 MHz: 16.88dBm | |
| Antenna Type | Main Antenna | PIFA Antenna |
| | Aux. Antenna | |
| Antenna Gain | Main Antenna | 5250 MHz to 5350 MHz: -1.10 dBi 5470 MHz to 5725 MHz: -1.10 dBi (In test items related to antenna gain, the final results reflect this figure. This value is provided by the applicant.) |
| | Aux. Antenna | 5250 MHz to 5350 MHz: -1.60 dBi 5470 MHz to 5725 MHz: -1.60 dBi (In test items related to antenna gain, the final results reflect this figure. This value is provided by the applicant.) |
| Note: This device (Client) is without radar detection, then the manufacturer statement confirming that information regarding the parameters of the detected Radar Waveforms is not available to the end user. And the device doesn't have Ad Hoc mode on DFS frequency band. | | |

3 SUMMARY OF TEST RESULTS

3.1 Test Standards

| No. | Identity | Document Title |
|-----|-------------------------------------|--|
| 1 | 47 CFR Part 15 Subpart E | Unlicensed National Information Infrastructure Devices |
| 2 | KDB Publication 905462 D02v02 | UNII DFS Compliance Procedures New Rules |
| 3 | KDB Publication 905462 D03v01r02 | UNII Clients Without Radar Detection New Rules |
| 4 | KDB Publication 789033 D02v02r01 | Guidelines for Compliance Testing of Unlicensed National Information Infrastructure (U-NII) Devices Part 15, Subpart E |

3.2 Test Verdict

| No. | Description | FCC Part No. | Verdict | Remark |
|-----|-----------------------------------|--------------|---------|------------|
| 1 | Channel Move Time | 15.407 | Pass | Applicable |
| 2 | Channel Closing Transmission Time | 15.407 | Pass | Applicable |
| 3 | Non- Occupancy Period | 15.407 | Pass | Applicable |

3.3 Measurement Uncertainty

The following measurement uncertainty levels have been estimated for tests performed on the EUT as specified in CISPR 16-4-2. This uncertainty represents an expanded uncertainty expressed at approximately the 95% confidence level using a coverage factor of $k=2$.

| Parameters | Uncertainty |
|-----------------------------------|-------------|
| Occupied Channel Bandwidth | 2.8% |
| RF output power, conducted | 1.28 dB |
| Power Spectral Density, conducted | 1.30 dB |
| Unwanted Emissions, conducted | 1.84 dB |
| All emissions, radiated | 5.36 dB |
| Temperature | 0.82°C |
| Humidity | 4.1% |

4 GENERAL TEST CONFIGURATIONS

4.1 Test Environments

During the measurement, the normal environmental conditions were within the listed ranges:

| | | |
|----------------------------|-------------------------|----------------|
| Relative Humidity | 45% to 55% | |
| Atmospheric Pressure | 100 kPa to 102 kPa | |
| Temperature | NT (Normal Temperature) | +22°C to +25°C |
| | LT (Low Temperature) | -10°C |
| | HT (High Temperature) | +55°C |
| Working Voltage of the EUT | NV (Normal Voltage) | 7.78 V |
| | LV (Low Voltage) | 7.20 V |
| | HV (High Voltage) | 8.90 V |

4.2 Test Equipment List

| Description | Manufacturer | Model | Serial No. | Cal. Date | Cal. Due |
|-----------------------------------|-------------------------|-------------------|------------|------------|------------|
| Spectrum Analyzer | ROHDE&SCHWARZ | FSV-40 | 101544 | 2022.01.04 | 2023.01.03 |
| Bluetooth Signaling Unit | ROHDE&SCHWARZ | CMW500 | 142028 | 2021.06.01 | 2022.05.31 |
| Spectrum Analyzer | ROHDE&SCHWARZ | FSV-30 | 103118 | 2021.08.09 | 2022.08.08 |
| Vector Signal Generator | ROHDE&SCHWARZ | SMBV100A | 260592 | 2021.01.27 | 2022.01.26 |
| Vector Signal Generator | ROHDE&SCHWARZ | SMBV100A | 260592 | 2022.02.09 | 2023.02.08 |
| Signal Generator | ROHDE&SCHWARZ | SMB100A | 177746 | 2021.08.24 | 2022.08.23 |
| Switch Unit with OSP-B157 | ROHDE&SCHWARZ | OSP120 | 101270 | 2021.06.01 | 2022.05.31 |
| Power Sensor | KEYSIGHT | U2063XA | MY58000247 | 2021.05.08 | 2022.05.07 |
| EMI Receiver | KEYSIGHT | N9038A | MY53220118 | 2021.09.13 | 2022.09.12 |
| EMI Receiver | ROHDE&SCHWARZ | ESRP | 101036 | 2021.10.10 | 2022.10.09 |
| LISN | SCHWARZBECK | NSLK 8127 | 8127-687 | 2021.06.08 | 2022.06.07 |
| Test Antenna-Loop(9 kHz-30 MHz) | SCHWARZBECK | FMZB 1519 | 1519-037 | 2021.04.16 | 2024.04.15 |
| Test Antenna-Bi-Log(30 MHz-3 GHz) | SCHWARZBECK | VULB 9163 | 9163-624 | 2021.08.20 | 2024.08.19 |
| Test Antenna-Horn(1-18 GHz) | SCHWARZBECK | BBHA 9120D | 9120D-1917 | 2019.07.02 | 2022.07.01 |
| Test Antenna-Horn (18-40 GHz) | A-INFO | LB-180400KF | J211060273 | 2021.07.02 | 2024.07.01 |
| Anechoic Chamber | RAINFORD | 9m*6m*6m | N/A | 2021.09.04 | 2024.09.09 |
| Anechoic Chamber | EMC Electronic Co., Ltd | 20.10*11.60*7.35m | N/A | 2021.08.15 | 2024.08.14 |

| Description | Manufacturer | Model | Serial No. | Cal. Date | Cal. Due |
|--------------------|--------------|-----------|------------|-----------|----------|
| Shielded Enclosure | ChangNing | CN-130701 | 130703 | -- | -- |

| | | |
|--------|--------------|--|
| Master | Access Point | |
| | Brand Name | Aerohive |
| | Model No. | AP230 |
| | Serial No. | AH-AP-230-AC-W |
| | FCC ID | WBV-AP230 |
| | SPEC. | The maximum EIRP is 18.5dBm, Antenna Gain is 6.57dBi |

4.3 Test Software List

| Description | Manufacturer | Software Version | Serial No. | Applicable test Setup |
|-------------|--------------|------------------|------------|-----------------------|
| BL410R | BALUN | V2.1.1.488 | N/A | The section 4.4.1 |

4.4 Description of Test Setup

4.4.1 Conducted Test Setup Configuration

Client without Radar Detection Mode

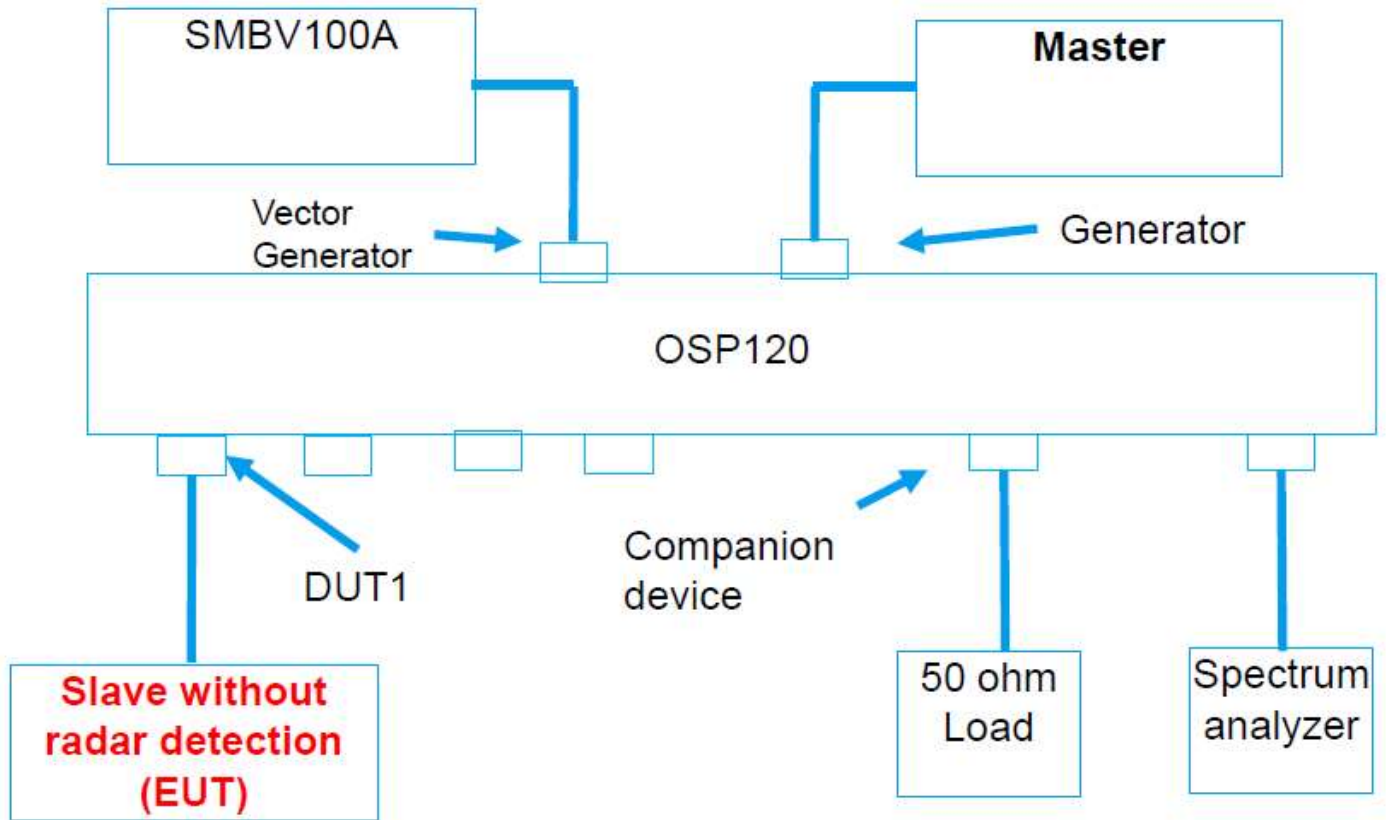

The UUT is a U-NII Device operating in Client mode without radar detection. The radar test signals are injected into the Master Device.

(Diagram 1)

5 TEST ITEMS

5.1 DFS

5.1.1 U-NII DFS Rule Requirements

5.1.1.1 Working Mode and Required Test Items

The manufacturer shall state whether the UUT is capable of operating as a Master and/or a Client. If the UUT is capable of operating in more than one operating mode then each operating mode shall be tested separately. See tables 1 and 2 for the applicability of DFS requirements for each of the operational modes.

APPLICABILITY OF DFS REQUIREMENTS PRIOR TO USE A CHANNEL

| Requirement | Operational Mode | | |
|---------------------------------|------------------|--------------------------------|-----------------------------|
| | Master | Client without radar detection | Client with radar detection |
| Non-Occupancy Period | ✓ | ✓ | ✓ |
| DFS Detection Threshold | ✓ | Not required | ✓ |
| Channel Availability Check Time | ✓ | Not required | Not required |
| Uniform Spreading | ✓ | Not required | Not required |
| U-NII Detection Bandwidth | ✓ | Not required | ✓ |

APPLICABILITY OF DFS REQUIREMENTS DURING NORMAL OPERATION

| Requirement | Operational Mode | | |
|-----------------------------------|------------------|--------------------------------|-----------------------------|
| | Master | Client without radar detection | Client with radar detection |
| DFS Detection Threshold | ✓ | Not required | ✓ |
| Channel Closing Transmission Time | ✓ | ✓ | ✓ |
| Channel Move Time | ✓ | ✓ | ✓ |
| U-NII Detection Bandwidth | ✓ | Not required | ✓ |

5.1.2 Test Limits and Radar Signal Parameters

Detection Threshold Values

DFS DETECTION THRESHOLDS FOR MASTER DEVICES AND CLIENT DEVICES WITH RADAR DETECTION

| Maximum Transmit Power | Value (See Note ¹ & ²) |
|------------------------|---|
| ≥ 200 milliwatt | -64 dBm |
| < 200 milliwatt | -62 dBm |

Note ¹: This is the level at the input of the receiver assuming a 0 dBi receive antenna.

Note ²: Throughout these test procedures an additional 1 dB has been added to the amplitude of the test transmission waveforms to account for variations in measurement equipment. This will ensure that the test signal is at or above the detection threshold level to trigger a DFS response.

DFS RESPONSE REQUIREMENT VALUES

| Parameter | Value |
|-----------------------------------|--|
| Non-occupancy period | Minimum 30 minutes |
| Channel Availability Check Time | 60 seconds |
| Channel Move Time | 10 seconds See Note ¹ . |
| Channel Closing Transmission Time | 200 milliseconds + an aggregate of 60 milliseconds over remaining 10 second period. See Note ^{1&2} . |
| U-NII Detection Bandwidth | 100% of the UNII transmission power bandwidth. See Note ³ . |

Note ¹: The instant that the Channel Move Time and the Channel Closing Transmission Time begins is as follows:

- For the Short Pulse Radar Test Signals this instant is the end of the Burst.
- For the Frequency Hopping radar Test Signal, this instant is the end of the last radar Burst generated.
- For the Long Pulse Radar Test Signal this instant is the end of the 12 second period defining the Radar Waveform.

Note ²: The Channel Closing Transmission Time is comprised of 200 milliseconds starting at the beginning of the Channel Move Time plus any additional intermittent control signals required to facilitate a Channel move (an aggregate of 60 milliseconds) during the remainder of the 10 second period. The aggregate duration of control signals will not count quiet periods in between transmissions.

Note ³: During the U-NII Detection Bandwidth detection test, radar type 1 is used and for each frequency step the minimum percentage of detection is 90 percent. Measurements are performed with no data traffic.

Parameters of DFS Test Signals

Step intervals of 0.1 microsecond for Pulse Width, 1 microsecond for PRI, 1 MHz for chirp width and 1 for the number of pulses will be utilized for the random determination of specific test waveforms.

SHORT PULSE RADAR TEST WAVEFORMS

| Radar Type | Pulse Width (μsec) | PRI (μsec) | Number of Pulses | Minimum Percentage of Successful Detection | Minimum Number of Trials |
|--|--------------------|---|--|--|--------------------------|
| 0 | 1 | 1428 | 18 | See Note | See Note |
| 1 | 1 | Test A: 15 unique PRI values randomly selected from the list of 23 PRI values in Table 5a | $\text{Roundup} \left\{ \left(\frac{1}{360} \right) \cdot \left(\frac{19 \cdot 10^6}{\text{PRI}_{\mu\text{sec}}} \right) \right\}$ | 60% | 30 |
| | | Test B: 15 unique PRI values randomly selected within the range of 518-3066 μsec, with a minimum increment of 1 μsec, excluding PRI values selected in Test A | | | |
| 2 | 1-5 | 150-230 | 23-29 | 60% | 30 |
| 3 | 6-10 | 200-500 | 16-18 | 60% | 30 |
| 4 | 11-20 | 200-500 | 12-16 | 60% | 30 |
| Aggregate (Radar Types 1-4) | | | | 80% | 120 |
| Note: Short Pulse Radar Type 0 should be used for the detection bandwidth test, channel move time, and channel closing time tests. | | | | | |

LONG PULSE RADAR TEST WAVEFORM

| Radar Type | Pulse Width (μsec) | Chirp Width (MHz) | PRI (μsec) | Number of Pulses per Burst | Number of Bursts | Minimum Percentage of Successful Detection | Minimum Number of Trials |
|------------|--------------------|-------------------|------------|----------------------------|------------------|--|--------------------------|
| 5 | 50-100 | 5-20 | 1000-2000 | 1-3 | 8-20 | 80% | 30 |

FREQUENCY HOPPING RADAR TEST WAVEFORM

| Radar Type | Pulse Width (μsec) | PRI (μsec) | Pulses per Hop | Hopping Rate (kHz) | Hopping Sequence Length (msec) | Minimum Percentage of Successful Detection | Minimum Number of Trials |
|------------|--------------------|------------|----------------|--------------------|--------------------------------|--|--------------------------|
| 6 | 1 | 333 | 9 | 0.333 | 300 | 70% | 30 |

5.1.2.1 Test Setup

See 4.4 for test setup description for the radiated test. The photo of test setup please refer to ANNEX B.

5.1.2.2 Test Procedure

DFS MEASUREMENT SYSTEM:

A complete DFS Measurement System consists of two subsystems: (1) the Radar Signal Generating Subsystem and (2) the Traffic Monitoring Subsystem. The control PC is necessary for generating the Radar waveforms in Table 6, 7 and 8. The traffic monitoring subsystem is specified to the type of unit under test (UUT).

Conducted setup configuration of ADT DFS Measurement System

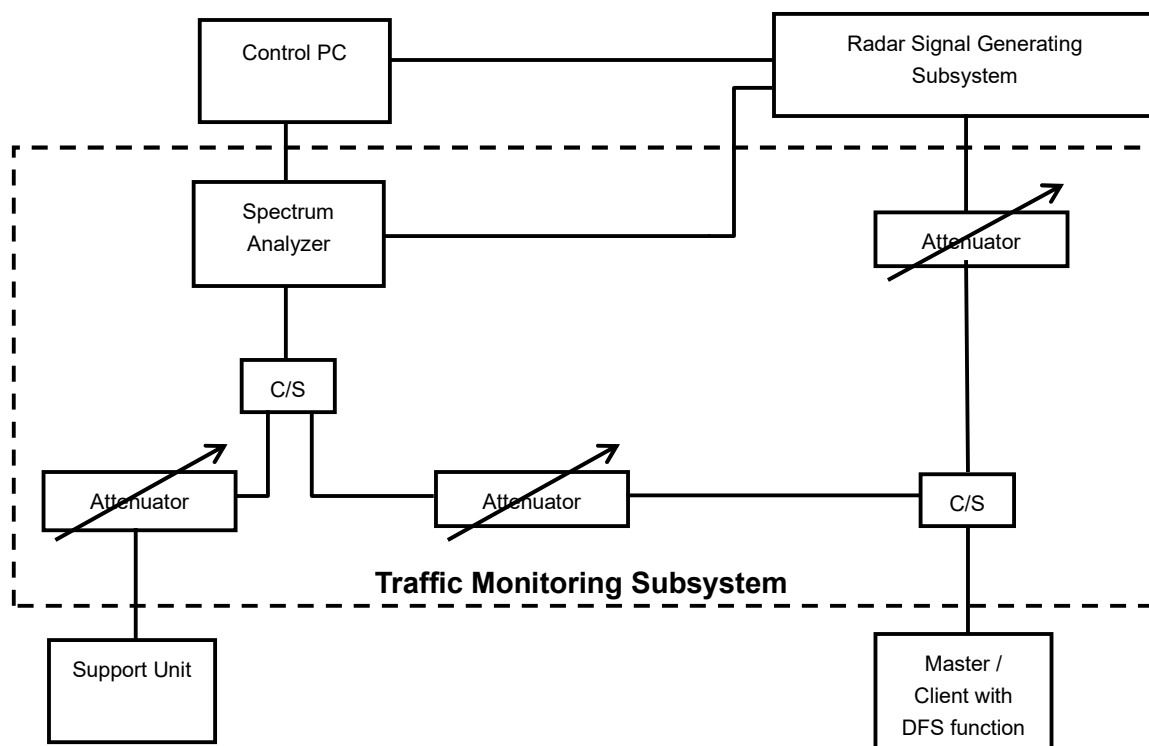

The test transmission will always be from the Master Device to the Client Device. While the Client device is set up to associate with the Master device and play the MPEG file (6 ½ Magic Hours) from Master device, the designated MPEG test file and instructions are located at: <http://ntiacsd.ntia.doc.gov/dfs/>.

CALIBRATION OF DFS DETECTION THRESHOLD LEVEL:

The measured channel is 5500 MHz in 20MHz Bandwidth and 5530MHz in 80MHz Bandwidth. The radar signal was the same as transmitted channels, and injected into the antenna port of AP (master) or Client Device with Radar Detection, measured the channel closing transmission time and channel move time. The Master antenna gain is 6.57dBi and required detection threshold is -54.43dBm (= -62 +1 +6.57)dBm. The calibrated conducted detection threshold level is set to -54.43 dBm.

Conducted setup configuration of Calibration of DFS Detection Threshold Level

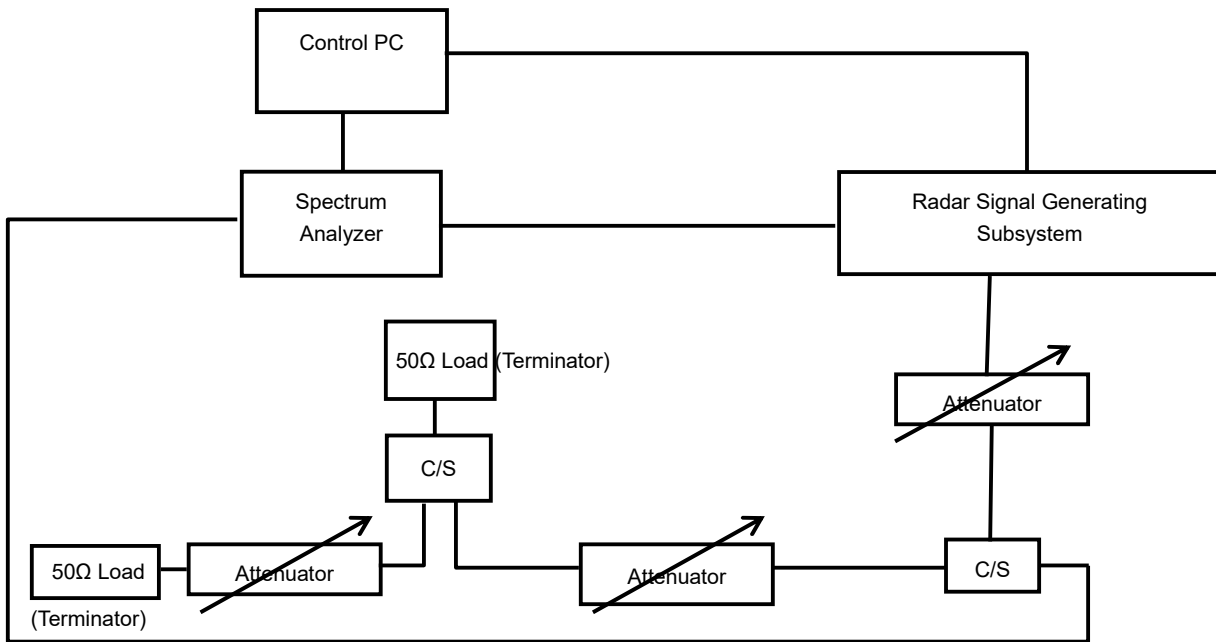

Radar Waveform Calibration Result

Radar Type 0 Calibration Plot (5290MHz)

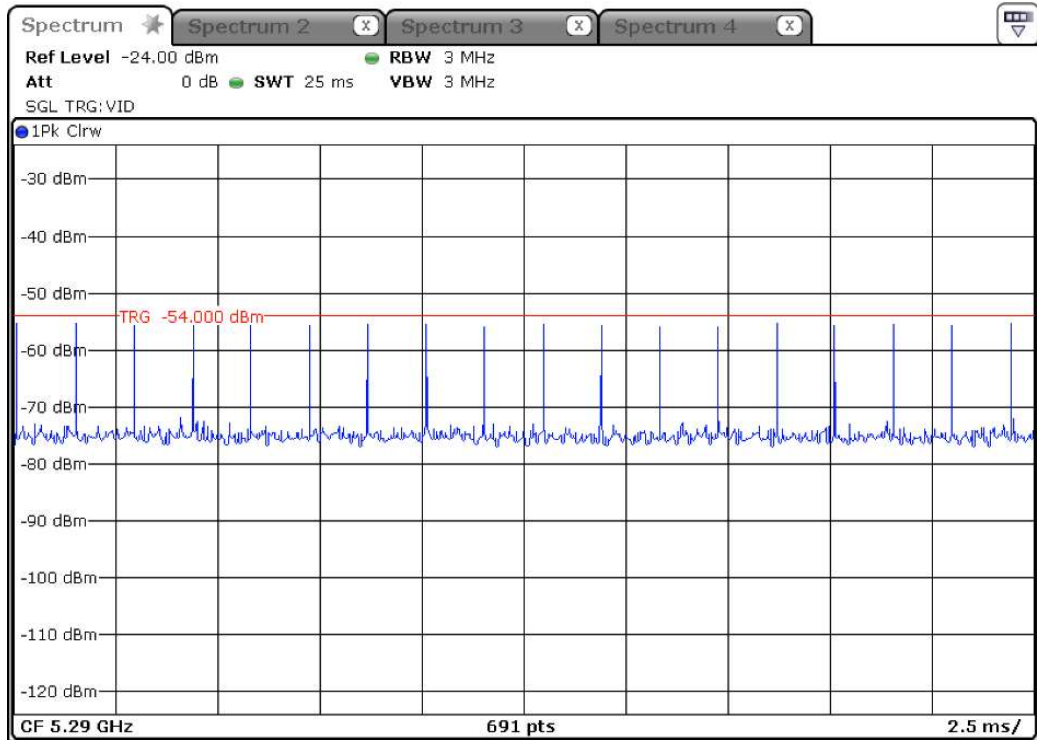

Radar Type 1 test A Calibration Plot (5290MHz)

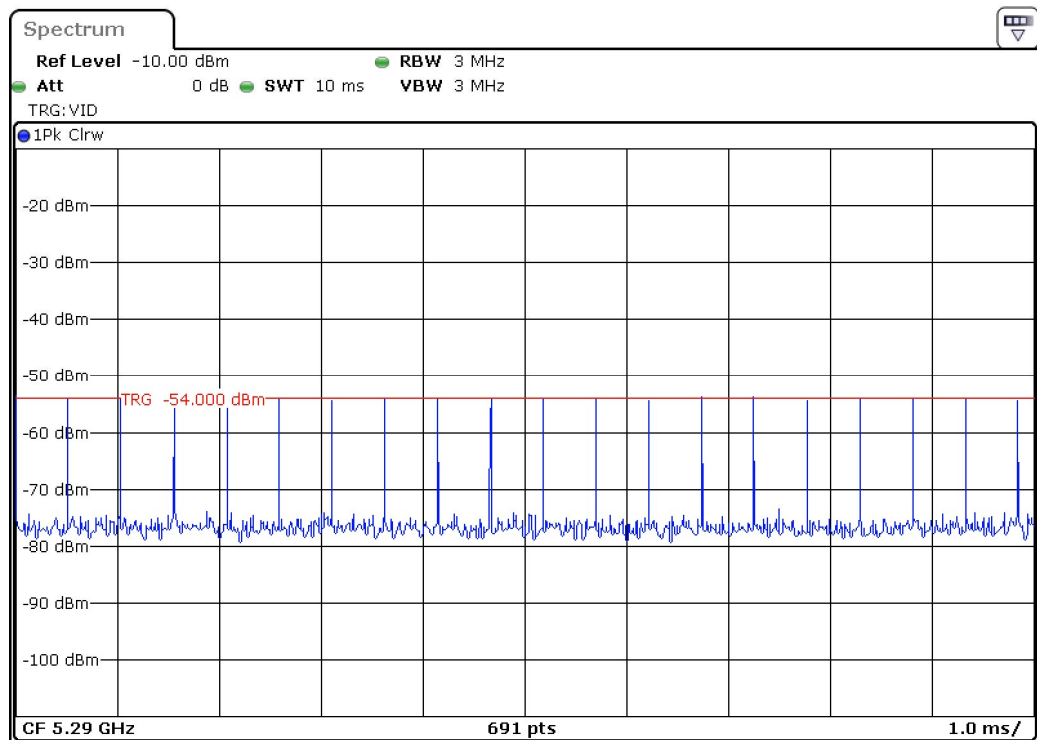

Radar Type 1 test B Calibration Plot (5290MHz)

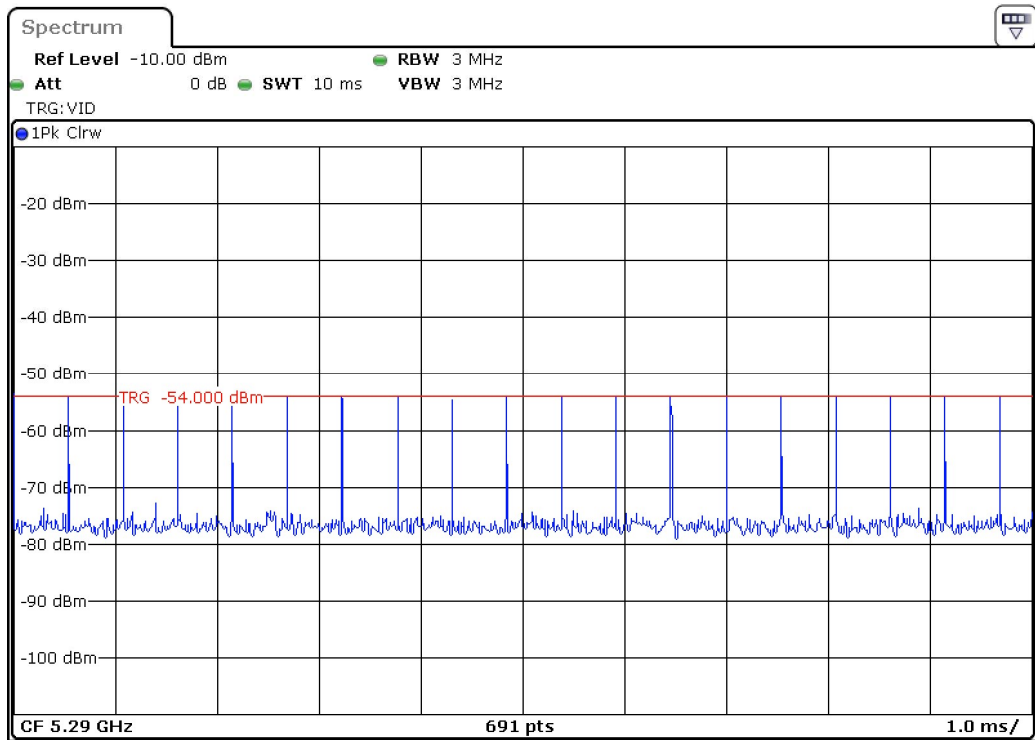

Radar Type 2 Calibration Plot (5290MHz)

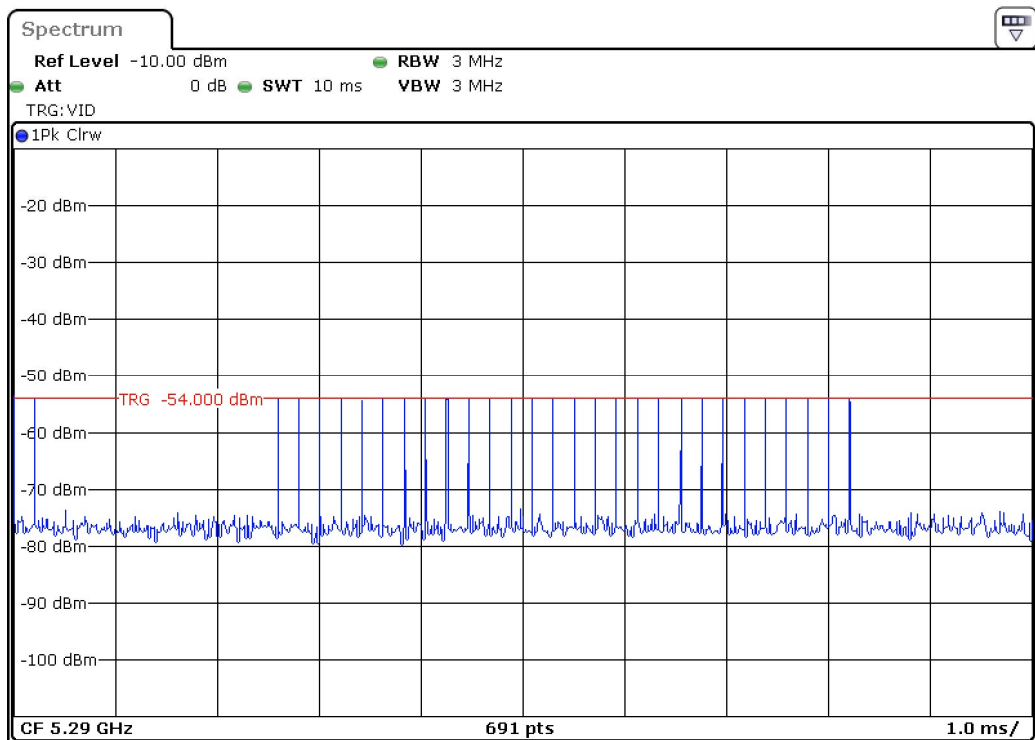

Radar Type 3 Calibration Plot (5290MHz)

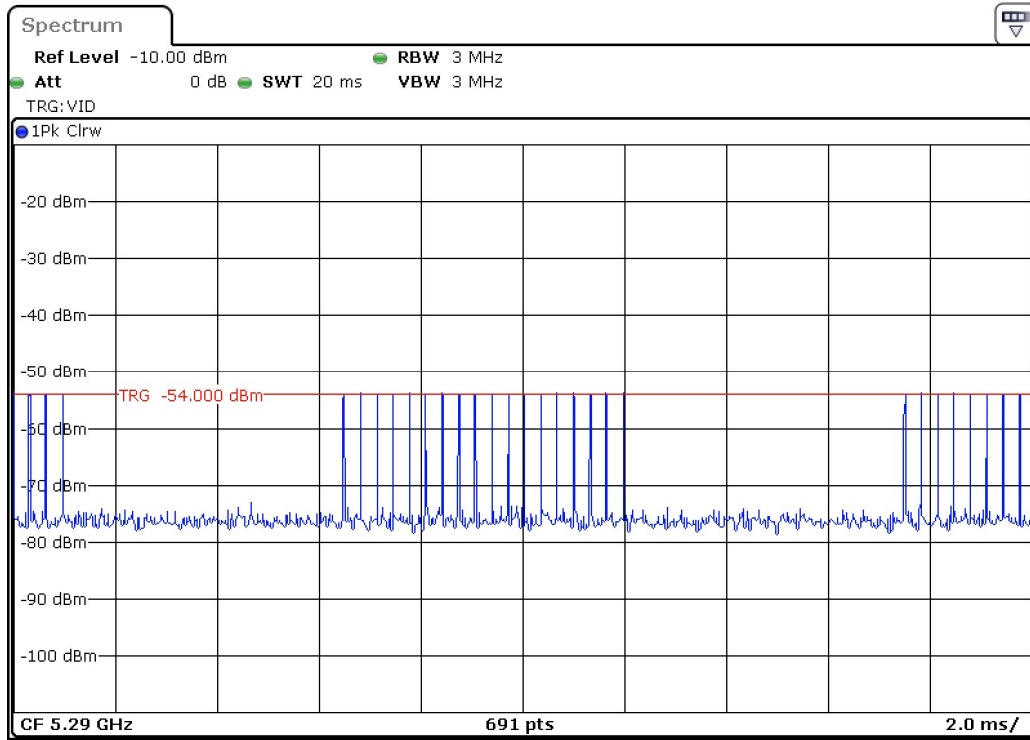

Radar Type 4 Calibration Plot (5290MHz)

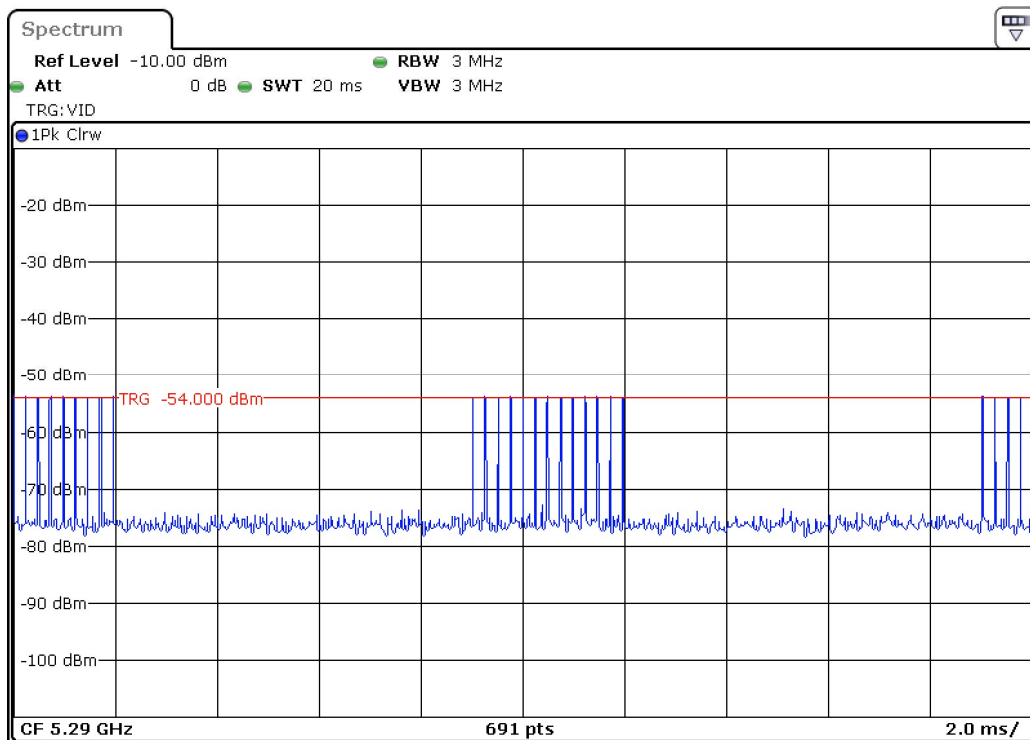

Radar Type 5 Calibration Plot (5290MHz)

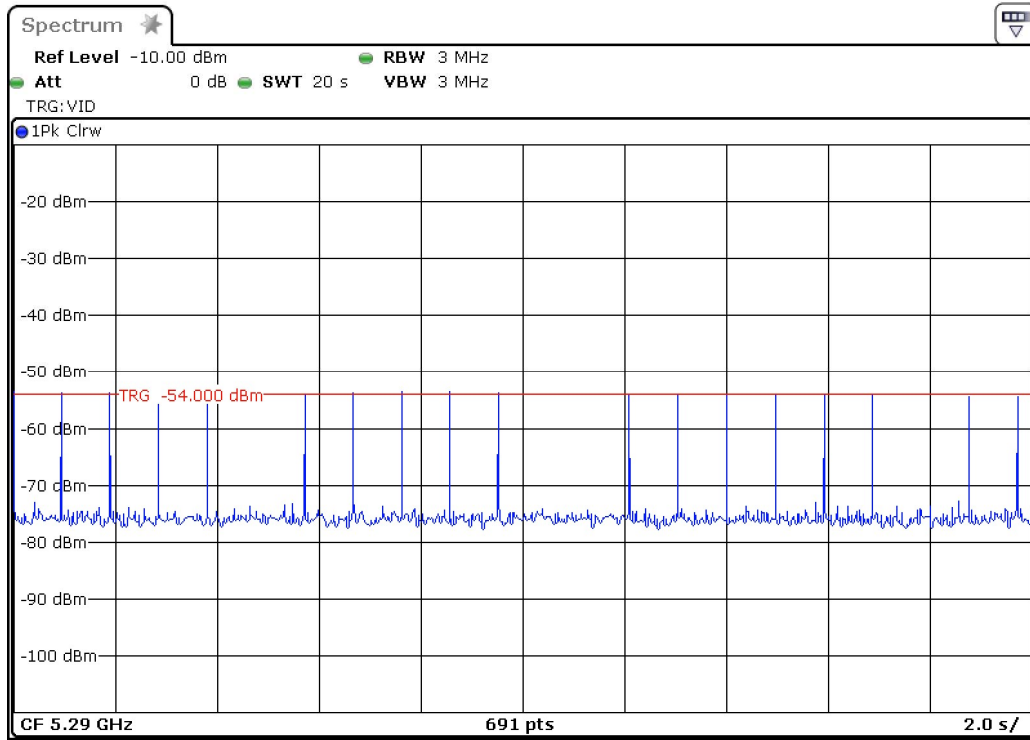

Radar Type 6 Calibration Plot (5290MHz)

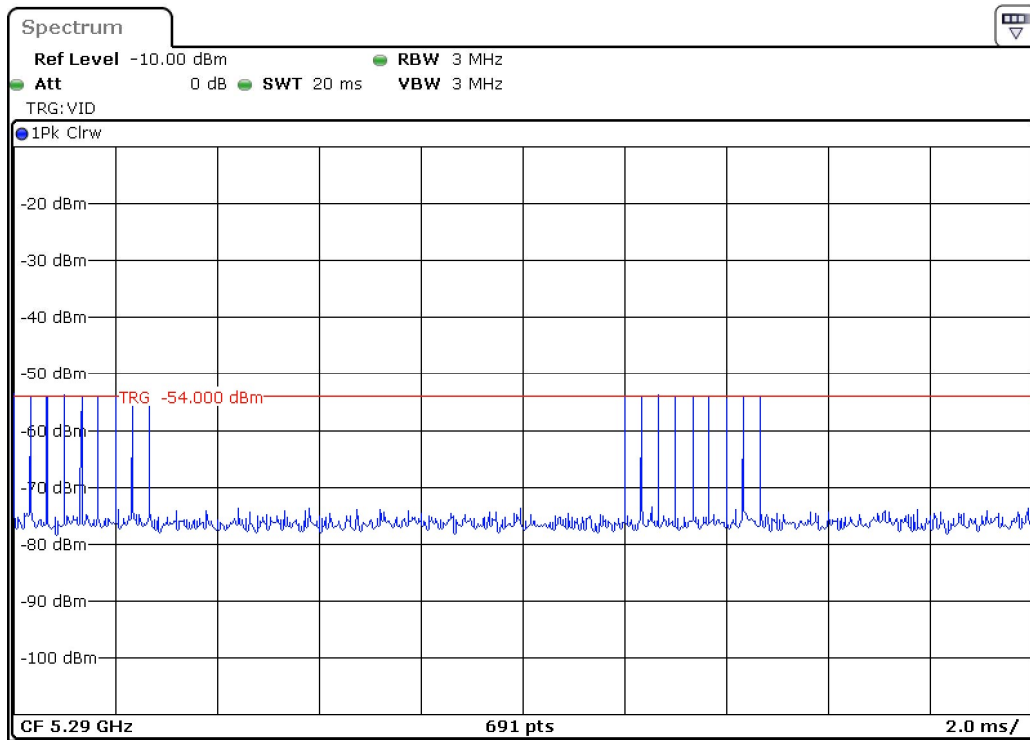

5.1.2.3 Test Result

Please refer to ANNEX A.

ANNEX A TEST RESULT

A.1 CHANNEL CLOSING TRANSMISSION AND CHANNEL MOVE TIME

Result of DFS Channel Shutdown

Note: The radar test signals are injected into the Master Device.

This test was investigated for different bandwidth (the lowest and the highest bandwidth).

| Description | Operation Mode | Operation Channel | Value (s) | Limit |
|-----------------------------------|-------------------|-------------------|-----------|---|
| Channel Move Time | 802.11a | 52 | 3.458 | 10 s |
| Channel Closing Transmission Time | 802.11a | 52 | 0.036 | 200 milliseconds + an aggregate of 60 milliseconds over remaining 10 second period. |
| Channel Move Time | 802.11a | 100 | 3.690 | 10 s |
| Channel Closing Transmission Time | 802.11a | 100 | 0.037 | 200 milliseconds + an aggregate of 60 milliseconds over remaining 10 second period. |
| Channel Move Time | 802.11ac (80 MHz) | 58 | 3.725 | 10 s |
| Channel Closing Transmission Time | 802.11ac (80 MHz) | 58 | 0.039 | 200 milliseconds + an aggregate of 60 milliseconds over remaining 10 second period. |
| Channel Move Time | 802.11ac (80 MHz) | 106 | 3.655 | 10 s |
| Channel Closing Transmission Time | 802.11ac (80 MHz) | 106 | 0.038 | 200 milliseconds + an aggregate of 60 milliseconds over remaining 10 second period. |
| Test Verdict | Pass | | | |

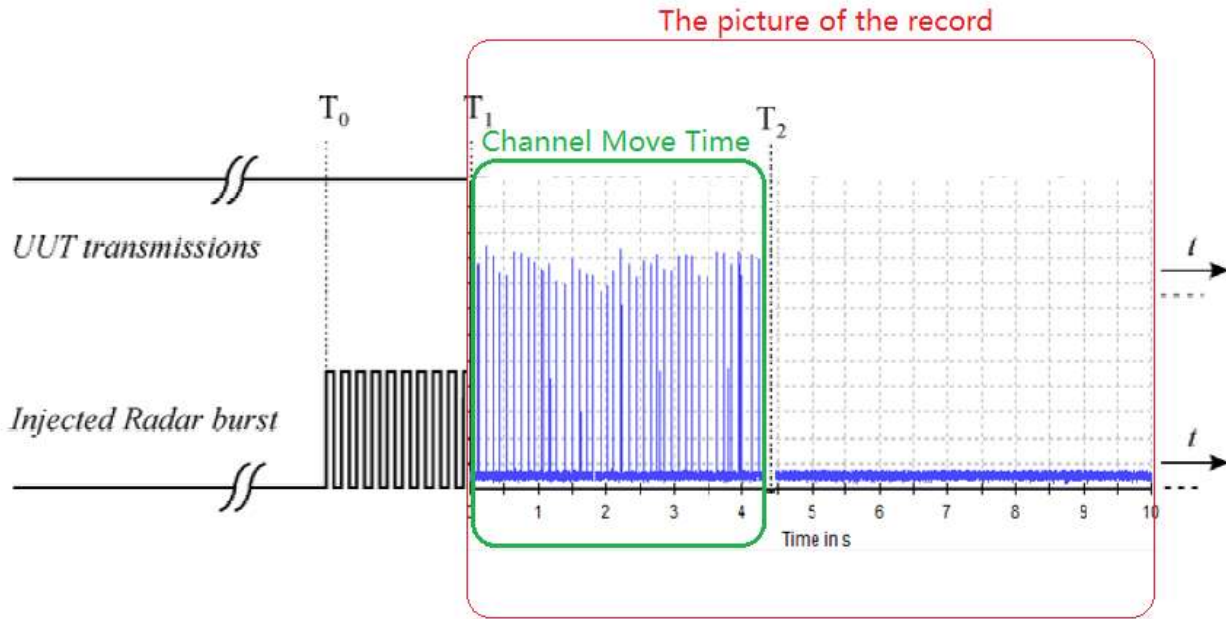

T_0 denotes DFS test signal start generated on the channel.

T_1 denotes the end of the radar burst.

T_2 denotes the instant when the UUT has ceased all transmissions on the channel.

The time difference between T_1 and T_2 shall be measured. This value (*Channel Move Time*) shall be noted and compared with the limit.

The aggregate duration (*Channel Closing Transmission Time*) of all transmissions from the UUT on Chr during the *Channel Move Time* shall be compared to the limit.

DFS Test schematic graphic

802.11a Channel 52

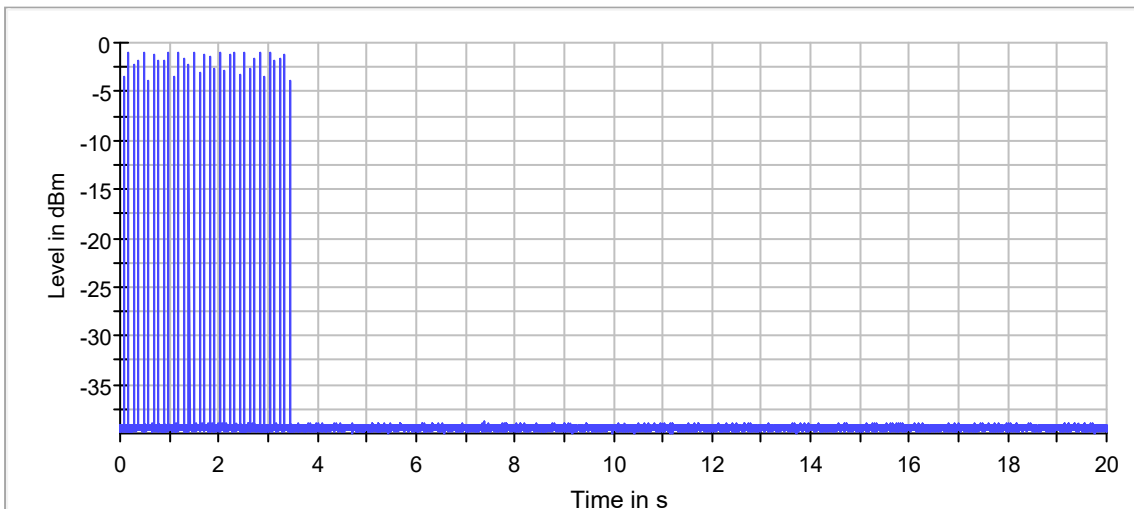

802.11a Channel 100

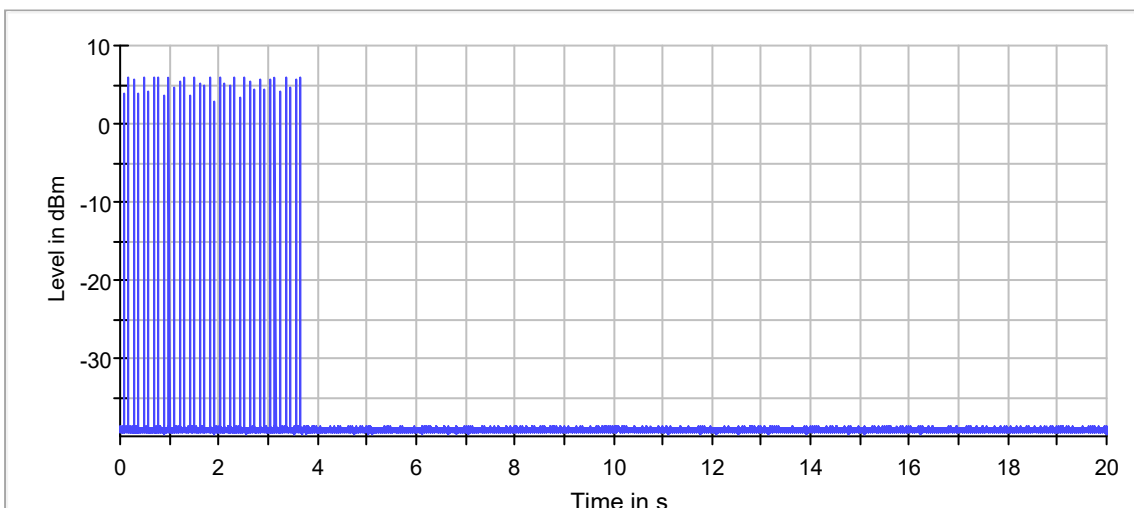

802.11ac(80 MHz) Channel 58

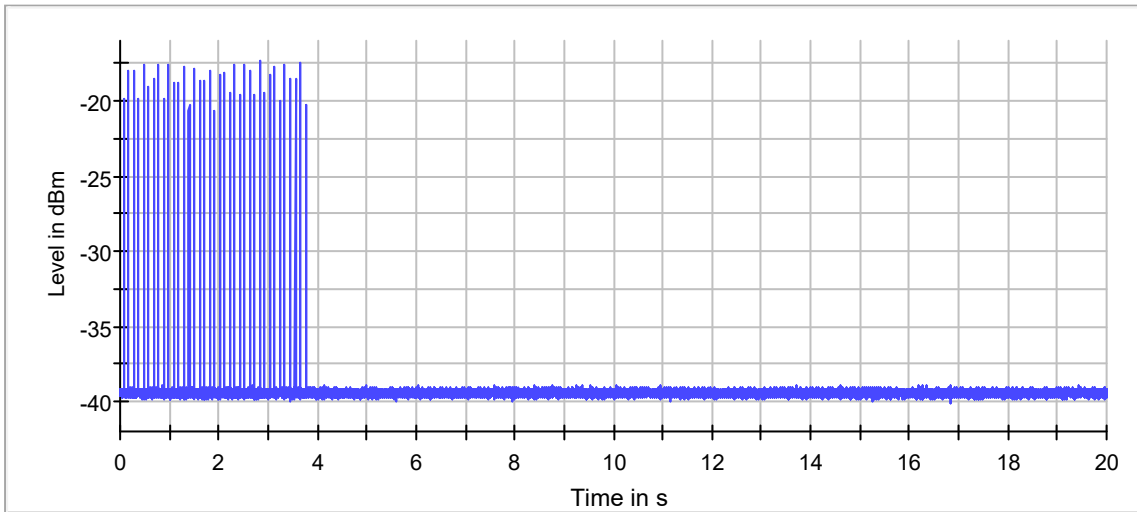

802.11ac(80 MHz) Channel 106

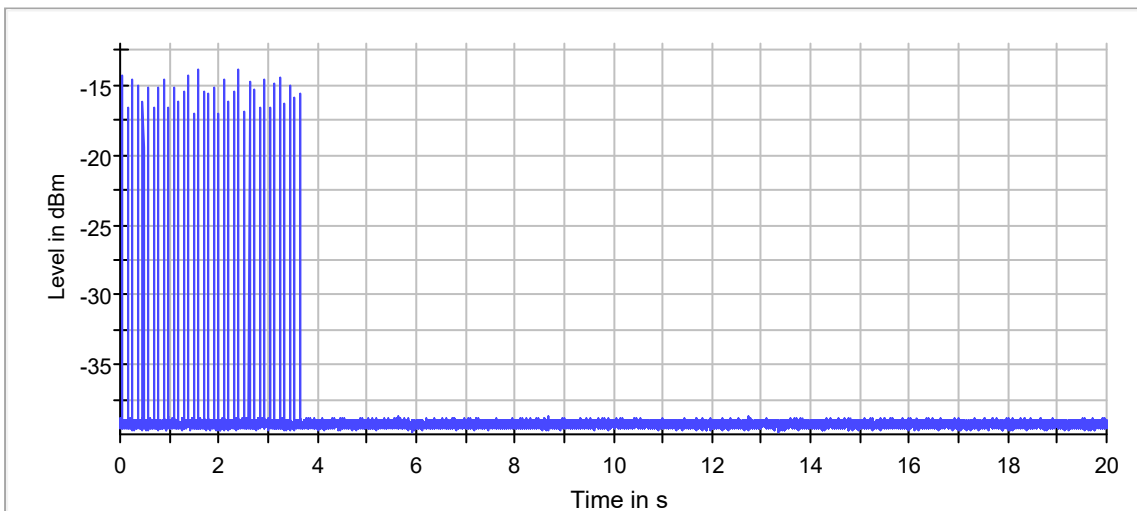

A.2 NON- OCCUPANCY PERIOD

Master was off.

During the 30 minutes observation time, The UUT did not make any transmissions in the DFS band after UUT power up.

802.11a Channel 52

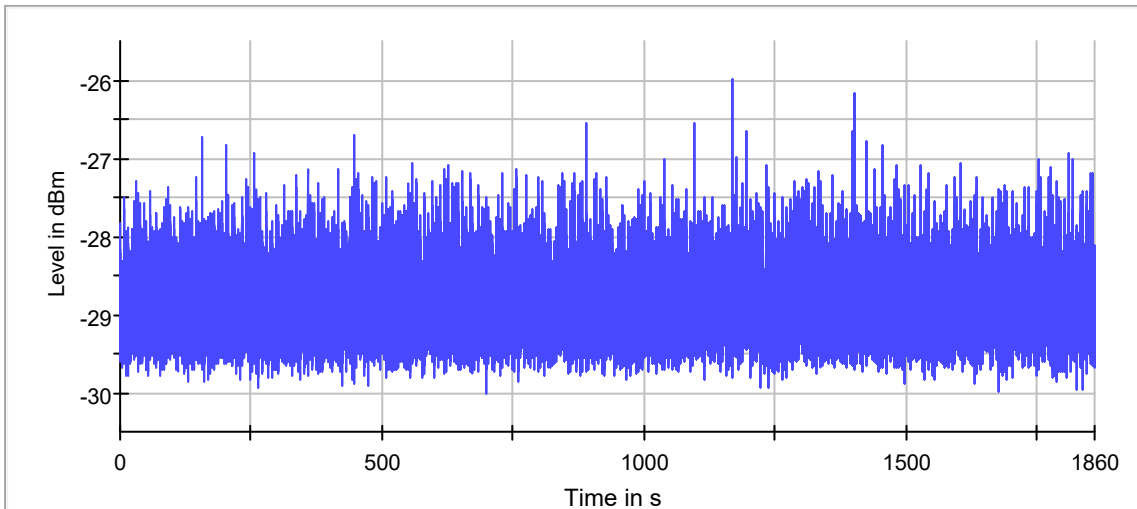

802.11a Channel 100

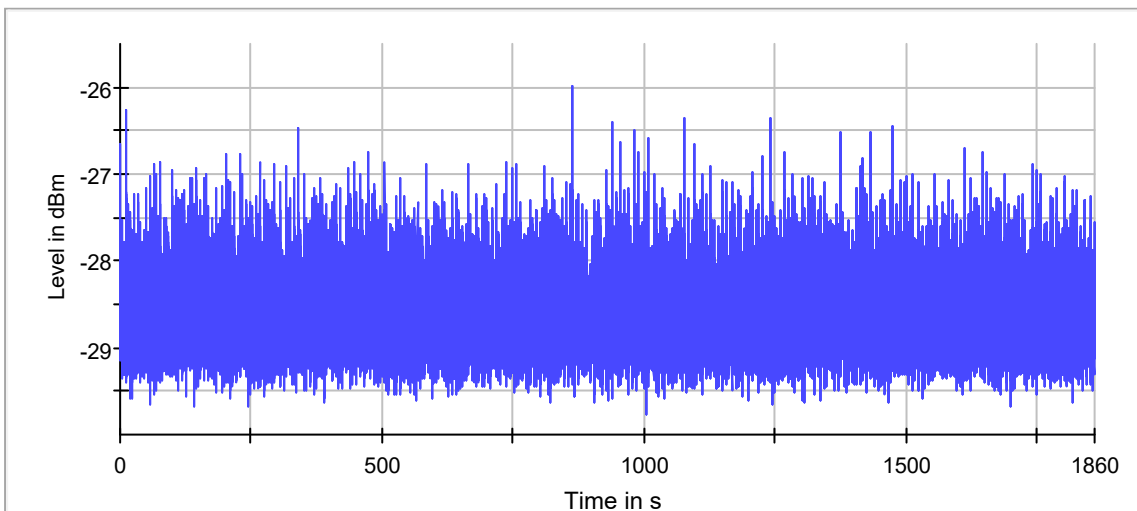

802.11ac(80 MHz) Channel 58

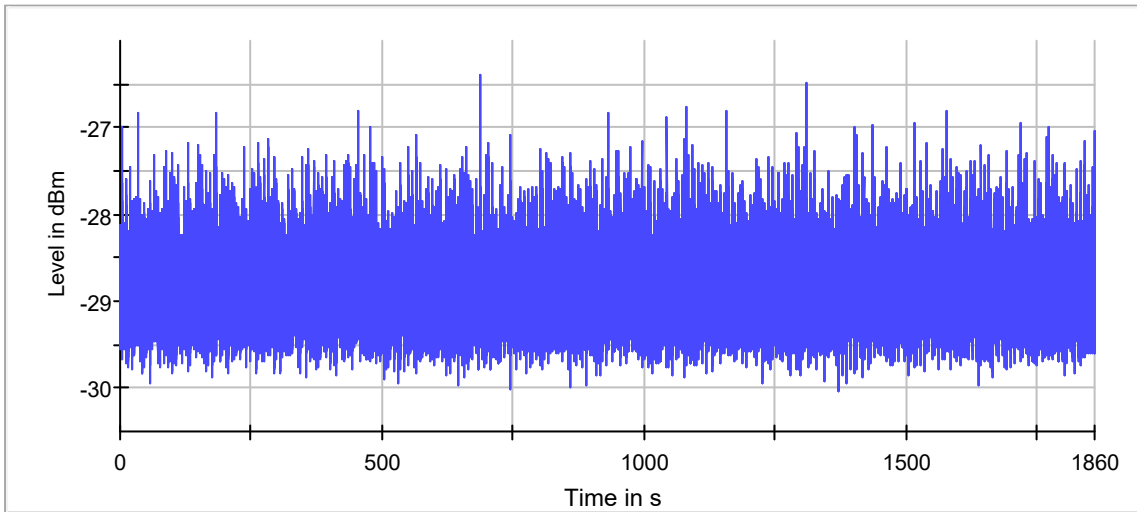

802.11ac(80 MHz) Channel 106

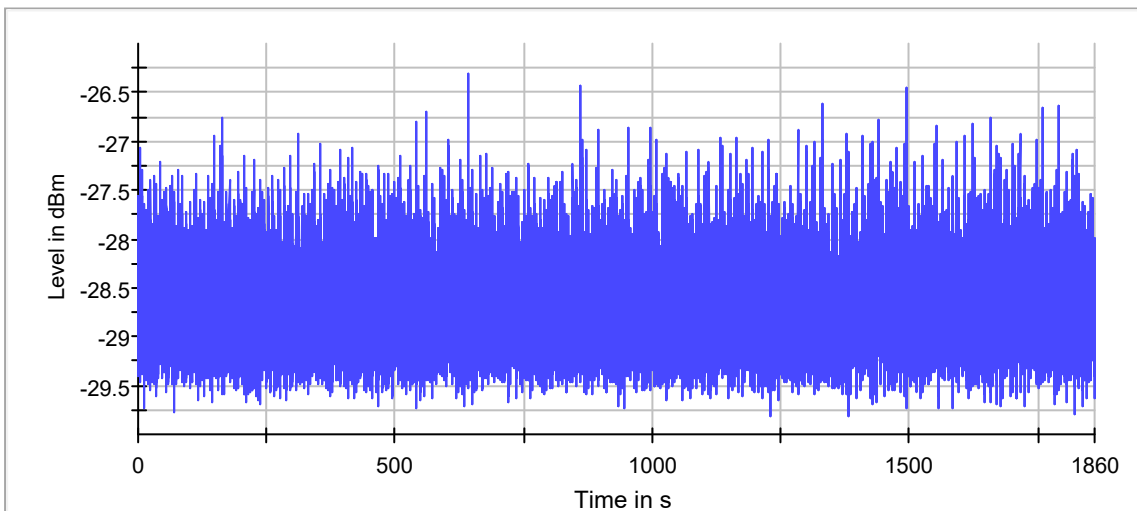

ANNEX B TEST SETUP PHOTOS

Please refer the document “BL-EC21C0857-AR.PDF”.

ANNEX C EUT EXTERNAL PHOTOS

Please refer the document “BL-EC21C0857-AW.PDF”.

ANNEX D EUT INTERNAL PHOTOS

Please refer the document “BL-EC21C0857-AI.PDF”.

Statement

1. The laboratory guarantees the scientificity, accuracy and impartiality of the test, and is responsible for all the information in the report, except the information provided by the customer. The customer is responsible for the impact of the information provided on the validity of the results.
2. For the report with CNAS mark or A2LA mark, the items marked with "☆" are not within the accredited scope.
3. This report is invalid if it is altered, without the signature of the testing and approval personnel, or without the "inspection and testing dedicated stamp" or test report stamp.
4. The test data and results are only valid for the tested samples provided by the customer.
5. This report shall not be partially reproduced without the written permission of the laboratory.
6. Any objection shall be raised to the laboratory within 30 days after receiving the report.

--END OF REPORT--