

# FCC Test Report

**Applicant** : Guangdong Nanguang Photo&Video Systems Co., Ltd.

**Address** : Dongli Section, Highway 324, Chenghai, Shantou City, Guangdong Province, China

**Product Name** : LED RGBWW Panel Light

**Report Date** : May 20, 2024



**Shenzhen Anbotek Compliance Laboratory Limited**

**Shenzhen Anbotek Compliance Laboratory Limited**

Address: 1/F., Building D, Sogood Science and Technology Park, Sanwei Community, Hangcheng Street, Bao'an District, Shenzhen, Guangdong, China.  
Tel: (86)0755-26066440 Fax: (86)0755-26014772 Email: service@anbotek.com



Hotline  
400-003-0500  
www.anbotek.com.cn



# Contents

|  |    |
|--|----|
| 1. General Information .....                         | 6  |
| 1.1. Client Information .....                        | 6  |
| 1.2. Description of Device (EUT) .....               | 6  |
| 1.3. Auxiliary Equipment Used During Test .....      | 7  |
| 1.4. Operation channel list .....                    | 7  |
| 1.5. Description of Test Modes .....                 | 7  |
| 1.6. Measurement Uncertainty .....                   | 8  |
| 1.7. Test Summary .....                              | 8  |
| 1.8. Description of Test Facility .....              | 9  |
| 1.9. Disclaimer .....                                | 9  |
| 1.10. Test Equipment List .....                      | 10 |
| 2. Antenna requirement .....                         | 12 |
| 2.1. Conclusion .....                                | 12 |
| 3. Conducted Emission at AC power line .....         | 13 |
| 3.1. EUT Operation .....                             | 13 |
| 3.2. Test Setup .....                                | 13 |
| 3.3. Test Data .....                                 | 14 |
| 4. Occupied Bandwidth .....                          | 16 |
| 4.1. EUT Operation .....                             | 16 |
| 4.2. Test Setup .....                                | 17 |
| 4.3. Test Data .....                                 | 17 |
| 5. Maximum Conducted Output Power .....              | 18 |
| 5.1. EUT Operation .....                             | 18 |
| 5.2. Test Setup .....                                | 18 |
| 5.3. Test Data .....                                 | 18 |
| 6. Power Spectral Density .....                      | 19 |
| 6.1. EUT Operation .....                             | 19 |
| 6.2. Test Setup .....                                | 19 |
| 6.3. Test Data .....                                 | 19 |
| 7. Emissions in non-restricted frequency bands ..... | 20 |
| 7.1. EUT Operation .....                             | 20 |
| 7.2. Test Setup .....                                | 20 |
| 7.3. Test Data .....                                 | 20 |
| 8. Band edge emissions (Radiated) .....              | 21 |
| 8.1. EUT Operation .....                             | 21 |
| 8.2. Test Setup .....                                | 22 |
| 8.3. Test Data .....                                 | 23 |
| 9. Emissions in frequency bands (below 1GHz) .....   | 24 |
| 9.1. EUT Operation .....                             | 24 |
| 9.2. Test Setup .....                                | 25 |
| 9.3. Test Data .....                                 | 26 |

**Shenzhen Anbotek Compliance Laboratory Limited**

Address: 1/F., Building D, Sogood Science and Technology Park, Sanwei Community, Hangcheng Street, Bao'an District, Shenzhen, Guangdong, China.  
Tel: (86)0755-26066440 Fax: (86)0755-26014772 Email: service@anbotek.com



Hotline  
400-003-0500  
www.anbotek.com.cn



|  |    |
|--|----|
| 10. Emissions in frequency bands (above 1GHz)..... | 28 |
| 10.1. EUT Operation.....                           | 28 |
| 10.2. Test Setup.....                              | 29 |
| 10.3. Test Data.....                               | 30 |
| APPENDIX I -- TEST SETUP PHOTOGRAPH.....           | 33 |
| APPENDIX II -- EXTERNAL PHOTOGRAPH.....            | 33 |
| APPENDIX III -- INTERNAL PHOTOGRAPH.....           | 33 |

**Shenzhen Anbotek Compliance Laboratory Limited**

Address: 1/F., Building D, Sogood Science and Technology Park, Sanwei Community, Hangcheng Street, Bao'an District, Shenzhen, Guangdong, China.  
Tel: (86)0755-26066440 Fax: (86)0755-26014772 Email: service@anbotek.com



Hotline  
400-003-0500  
www.anbotek.com.cn





Report No.: 18220WC40082601

FCC ID: 2A2Y8-ALIEN300C

Page 4 of 33

# TEST REPORT

Applicant : Guangdong Nanguang Photo&amp;Video Systems Co., Ltd.

Manufacturer : Guangdong Nanguang Photo&amp;Video Systems Co., Ltd.

Product Name : LED RGBWW Panel Light

Test Model No. : Alien 300C

Reference Model No. : N/A

Trade Mark : NANLITE

Rating(s) : Input: 100-240V~ 50/60Hz, 350W

**Test Standard(s) : FCC Part15 Subpart C, Section 15.247****Test Method(s) : ANSI C63.10-2020, KDB 558074 D01 15.247 Meas Guidance v05r02**

The device described above is tested by Shenzhen Anbotek Compliance Laboratory Limited to determine the maximum emission levels emanating from the device and the severe levels of the device can endure and its performance criterion. The measurement results are contained in this test report and Shenzhen Anbotek Compliance Laboratory Limited is assumed full of responsibility for the accuracy and completeness of these measurements. Also, this report shows that the EUT (Equipment Under Test) is technically compliant with above listed standard(s) requirements. This report applies to above tested sample only and shall not be reproduced in part without written approval of Shenzhen Anbotek Compliance Laboratory Limited.

Date of Receipt:

Apr. 23, 2024

Date of Test:

Apr. 23, 2024 to May 11, 2024

Prepared By:

*Nian Xiu Chen*

(Nianxiu Chen)

Approved &amp; Authorized Signer:

*Edward Pan*

(Edward Pan)

**Shenzhen Anbotek Compliance Laboratory Limited**

Address: 1/F., Building D, Sogood Science and Technology Park, Sanwei Community, Hangcheng Street, Bao'an District, Shenzhen, Guangdong, China.  
Tel: (86)0755-26066440 Fax: (86)0755-26014772 Email: service@anbotek.com



Hotline

400-003-0500

www.anbotek.com.cn



**Revision History**

| Report Version | Description     | Issued Date  |
|----------------|-----------------|--------------|
| R00            | Original Issue. | May 20, 2024 |
|                |                 |              |
|                |                 |              |

**Shenzhen Anbotek Compliance Laboratory Limited**

Address: 1/F., Building D, Sogood Science and Technology Park, Sanwei Community, Hangcheng Street, Bao'an District, Shenzhen, Guangdong, China.  
Tel: (86)0755-26066440 Fax: (86)0755-26014772 Email: service@anbotek.com



Hotline  
400-003-0500  
www.anbotek.com.cn



## 1. General Information

### 1.1. Client Information

|              |   |  |
|--------------|---|--|
| Applicant    | : | Guangdong Nanguang Photo&Video Systems Co., Ltd.                               |
| Address      | : | Dongli Section, Highway 324, Chenghai, Shantou City, Guangdong Province, China |
| Manufacturer | : | Guangdong Nanguang Photo&Video Systems Co., Ltd.                               |
| Address      | : | Dongli Section, Highway 324, Chenghai, Shantou City, Guangdong Province, China |
| Factory      | : | Guangdong Nanguang Photo&Video Systems Co., Ltd.                               |
| Address      | : | Dongli Section, Highway 324, Chenghai, Shantou City, Guangdong Province, China |

### 1.2. Description of Device (EUT)

|                     |   |   |
|---------------------|---|---|
| Product Name        | : | LED RGBWW Panel Light                           |
| Test Model No.      | : | Alien 300C                                      |
| Reference Model No. | : | N/A   |
| Trade Mark          | : | NANLITE   |
| Test Power Supply   | : | AC 120V/60Hz                                    |
| Test Sample No.     | : | 1-2-1(Normal Sample), 1-2-2(Engineering Sample) |
| Adapter             | : | N/A   |

#### RF Specification

|                     |   |                    |
|---------------------|---|--------------------|
| Operation Frequency | : | 2402MHz to 2480MHz |
| Number of Channel   | : | 40                 |
| Modulation Type     | : | GFSK               |
| Antenna Type        | : | PCB Antenna        |
| Antenna Gain(Peak)  | : | 2.32dBi            |

#### Remark:

- (1) All of the RF specification are provided by customer.
- (2) For a more detailed features description, please refer to the manufacturer's specifications or the User's Manual.

#### Shenzhen Anbotek Compliance Laboratory Limited

Address: 1/F., Building D, Sogood Science and Technology Park, Sanwei Community, Hangcheng Street, Bao'an District, Shenzhen, Guangdong, China.  
Tel: (86)0755-26066440 Fax: (86)0755-26014772 Email: service@anbotek.com



Hotline  
400-003-0500  
www.anbotek.com.cn





### 1.3. Auxiliary Equipment Used During Test

| Title | Manufacturer                                     | Model No.  | Serial No. |
|-------|--|------------|------------|
| Light | Guangdong Nanguang Photo&Video Systems Co., Ltd. | Alien 300C | /          |

### 1.4. Operation channel list

Operation Band:

| Channel | Frequency (MHz) | Channel | Frequency (MHz) | Channel | Frequency (MHz) | Channel | Frequency (MHz) |
|---------|-----------------|---------|-----------------|---------|-----------------|---------|-----------------|
| 0       | 2402            | 10      | 2422            | 20      | 2442            | 30      | 2462            |
| 1       | 2404            | 11      | 2424            | 21      | 2444            | 31      | 2464            |
| 2       | 2406            | 12      | 2426            | 22      | 2446            | 32      | 2466            |
| 3       | 2408            | 13      | 2428            | 23      | 2448            | 33      | 2468            |
| 4       | 2410            | 14      | 2430            | 24      | 2450            | 34      | 2470            |
| 5       | 2412            | 15      | 2432            | 25      | 2452            | 35      | 2472            |
| 6       | 2414            | 16      | 2434            | 26      | 2454            | 36      | 2474            |
| 7       | 2416            | 17      | 2436            | 27      | 2456            | 37      | 2476            |
| 8       | 2418            | 18      | 2438            | 28      | 2458            | 38      | 2478            |
| 9       | 2420            | 19      | 2440            | 29      | 2460            | 39      | 2480            |

### 1.5. Description of Test Modes

| Pretest Modes | Descriptions  |
|---------------|---|
| TM1           | Keep the EUT works in continuously transmitting mode (BLE 1M) |
| TM2           | Keep the EUT works in continuously transmitting mode (BLE 2M) |



## 1.6. Measurement Uncertainty

| Parameter   | Uncertainty   |
|---|---|
| Conducted emissions (AMN 150kHz~30MHz)  | 3.4dB   |
| Occupied Bandwidth  | 925Hz   |
| Conducted Output Power  | 0.76dB  |
| Power Spectral Density  | 0.76dB  |
| Conducted Spurious Emission   | 1.24dB  |
| Radiated spurious emissions (above 1GHz)  | 1G-6GHz: 4.78dB;<br>6G-18GHz: 4.88dB<br>18G-40GHz: 5.68dB |
| Radiated emissions (Below 30MHz)  | 3.53dB  |
| Radiated spurious emissions (30MHz~1GHz)  | Horizontal: 3.92dB; Vertical: 4.52dB                      |
| The measurement uncertainty and decision risk evaluated according to AB/WI-RF-F-032.<br>This uncertainty represents an expanded uncertainty expressed at approximately the 95% confidence level using a coverage factor of k=2. |   |

## 1.7. Test Summary

| Test Items                                  | Test Modes | Status |
|---|------------|--------|
| Antenna requirement                         | /          | P      |
| Conducted Emission at AC power line         | Mode1,2    | P      |
| Occupied Bandwidth                          | Mode1,2    | P      |
| Maximum Conducted Output Power              | Mode1,2    | P      |
| Power Spectral Density                      | Mode1,2    | P      |
| Emissions in non-restricted frequency bands | Mode1,2    | P      |
| Band edge emissions (Radiated)              | Mode1,2    | P      |
| Emissions in frequency bands (below 1GHz)   | Mode1,2    | P      |
| Emissions in frequency bands (above 1GHz)   | Mode1,2    | P      |
| Note:<br>P: Pass<br>N: N/A, not applicable  |            |        |

### Shenzhen Anbotek Compliance Laboratory Limited

Address: 1/F., Building D, Sogood Science and Technology Park, Sanwei Community, Hangcheng Street, Bao'an District, Shenzhen, Guangdong, China.  
Tel: (86)0755-26066440 Fax: (86)0755-26014772 Email: service@anbotek.com



Hotline  
400-003-0500  
www.anbotek.com.cn





## 1.8. Description of Test Facility

The test facility is recognized, certified, or accredited by the following organizations:

### FCC-Registration No.: 434132

Shenzhen Anbotek Compliance Laboratory Limited, EMC Laboratory has been registered and fully described in a report filed with the (FCC) Federal Communications Commission. The acceptance letter from the FCC is maintained in our files. Registration No. 434132.

### ISED-Registration No.: 8058A

Shenzhen Anbotek Compliance Laboratory Limited, EMC Laboratory has been registered and fully described in a report filed with the (ISED) Innovation, Science and Economic Development Canada. The acceptance letter from the ISED is maintained in our files. Registration 8058A.

### Test Location

Shenzhen Anbotek Compliance Laboratory Limited.

1/F, Building D, Sogood Science and Technology Park, Sanwei community, Hangcheng Street, Bao'an District, Shenzhen, Guangdong, China.

## 1.9. Disclaimer

1. The test report is invalid if not marked with the signatures of the persons responsible for preparing and approving the test report.
2. The test report is invalid if there is any evidence and/or falsification.
3. The results documented in this report apply only to the tested sample, under the conditions and modes of operation as described herein.
4. This document may not be altered or revised in any way unless done so by Anbotek and all revisions are duly noted in the revisions section.
5. Content of the test report, in part or in full, cannot be used for publicity and/or promotional purposes without prior written approval from the laboratory.
6. The authenticity of the information provided by the customer is the responsibility of the customer and the laboratory is not responsible for its authenticity.

The laboratory is only responsible for the data released by the laboratory, except for the part provided by the applicant.

### Shenzhen Anbotek Compliance Laboratory Limited

Address: 1/F., Building D, Sogood Science and Technology Park, Sanwei Community, Hangcheng Street, Bao'an District, Shenzhen, Guangdong, China.  
Tel: (86)0755-26066440 Fax: (86)0755-26014772 Email: service@anbotek.com



Hotline  
400-003-0500  
www.anbotek.com.cn



**1.10. Test Equipment List**

| Conducted Emission at AC power line |   |                  |           |               |            |              |
|-------------------------------------|---|------------------|-----------|---------------|------------|--------------|
| Item                                | Equipment                                   | Manufacturer     | Model No. | Serial No.    | Last Cal.  | Cal.Due Date |
| 1                                   | L.I.S.N. Artificial Mains Network           | Rohde & Schwarz  | ENV216    | 100055        | 2024-01-18 | 2025-01-17   |
| 2                                   | Three Phase V-type Artificial Power Network | CYBERTEK         | EM5040DT  | E215040D T001 | 2024-01-17 | 2025-01-16   |
| 3                                   | Software Name EZ-EMC                        | Farad Technology | ANB-03A   | N/A           | /          | /            |
| 4                                   | EMI Test Receiver                           | Rohde & Schwarz  | ESPI3     | 100926        | 2023-10-12 | 2024-10-11   |

| Maximum Conducted Output Power<br>Power Spectral Density<br>Emissions in non-restricted frequency bands<br>Occupied Bandwidth |                                       |                 |            |              |            |              |
|---|---------------------------------------|-----------------|------------|--------------|------------|--------------|
| Item  | Equipment                             | Manufacturer    | Model No.  | Serial No.   | Last Cal.  | Cal.Due Date |
| 1   | Constant Temperature Humidity Chamber | ZHONGJIAN       | ZJ-KHWS80B | N/A          | 2023-10-16 | 2024-10-15   |
| 2   | DC Power Supply                       | IVYTECH         | IV3605     | 1804D360 510 | 2023-10-20 | 2024-10-19   |
| 3   | Spectrum Analyzer                     | Rohde & Schwarz | FSV40-N    | 101792       | 2023-05-26 | 2024-05-25   |
| 4   | MXA Spectrum Analysis                 | KEYSIGHT        | N9020A     | MY505318 23  | 2024-02-22 | 2025-02-21   |
| 5   | Oscilloscope                          | Tektronix       | MDO3012    | C020298      | 2023-10-12 | 2024-10-11   |
| 6   | MXG RF Vector Signal Generator        | Agilent         | N5182A     | MY474206 47  | 2024-02-04 | 2025-02-03   |

**Shenzhen Anbotek Compliance Laboratory Limited**

Address: 1/F., Building D, Sogood Science and Technology Park, Sanwei Community, Hangcheng Street, Bao'an District, Shenzhen, Guangdong, China.  
Tel: (86)0755-26066440 Fax: (86)0755-26014772 Email: service@anbotek.com



Hotline  
400-003-0500  
www.anbotek.com.cn



| Band edge emissions (Radiated)<br>Emissions in frequency bands (above 1GHz) |                            |                  |                   |             |            |              |
|---|----------------------------|------------------|-------------------|-------------|------------|--------------|
| Item  | Equipment                  | Manufacturer     | Model No.         | Serial No.  | Last Cal.  | Cal.Due Date |
| 1   | EMI Test Receiver          | Rohde & Schwarz  | ESR26             | 101481      | 2024-01-23 | 2025-01-22   |
| 2   | EMI Preamplifier           | SKET Electronic  | LNPA-0118G-45     | SKET-PA-002 | 2024-01-17 | 2025-01-16   |
| 3   | Double Ridged Horn Antenna | SCHWARZBECK      | BBHA 9120D        | 02555       | 2022-10-16 | 2025-10-15   |
| 4   | EMI Test Software EZ-EMC   | SHURPLE          | N/A               | N/A         | /          | /            |
| 5   | Horn Antenna               | A-INFO           | LB-180400-KF      | J211060628  | 2023-10-12 | 2024-10-11   |
| 6   | Spectrum Analyzer          | Rohde & Schwarz  | FSV40-N           | 101792      | 2023-05-26 | 2024-05-25   |
| 7   | Amplifier                  | Talent Microwave | TLLA18G40 G-50-30 | 23022802    | 2023-05-25 | 2024-05-24   |

| Emissions in frequency bands (below 1GHz) |                          |                 |            |            |            |              |
|---|--------------------------|-----------------|------------|------------|------------|--------------|
| Item                                      | Equipment                | Manufacturer    | Model No.  | Serial No. | Last Cal.  | Cal.Due Date |
| 1   | EMI Test Receiver        | Rohde & Schwarz | ESR26      | 101481     | 2024-01-23 | 2025-01-22   |
| 2   | Pre-amplifier            | SONOMA          | 310N       | 186860     | 2024-01-17 | 2025-01-16   |
| 3   | Bilog Broadband Antenna  | Schwarzbeck     | VULB9163   | 345        | 2022-10-23 | 2025-10-22   |
| 4   | Loop Antenna (9K-30M)    | Schwarzbeck     | FMZB1519 B | 00053      | 2023-10-12 | 2024-10-11   |
| 5   | EMI Test Software EZ-EMC | SHURPLE         | N/A        | N/A        | /          | /            |

### Shenzhen Anbotek Compliance Laboratory Limited

Address: 1/F., Building D, Sogood Science and Technology Park, Sanwei Community, Hangcheng Street, Bao'an District, Shenzhen, Guangdong, China.  
Tel: (86)0755-26066440 Fax: (86)0755-26014772 Email: service@anbotek.com



Hotline  
400-003-0500  
www.anbotek.com.cn





## 2. Antenna requirement

**Test Requirement:**

Refer to 47 CFR Part 15.203, an intentional radiator shall be designed to ensure that no antenna other than that furnished by the responsible party shall be used with the device. The use of a permanently attached antenna or of an antenna that uses a unique coupling to the intentional radiator shall be considered sufficient to comply with the provisions of this section.

### 2.1. Conclusion

The antenna is a **PCB Antenna** which permanently attached, and the best case gain of the antenna is **2.32dBi**. It complies with the standard requirement.

#### Shenzhen Anbotek Compliance Laboratory Limited

Address: 1/F., Building D, Sogood Science and Technology Park, Sanwei Community, Hangcheng Street, Bao'an District, Shenzhen, Guangdong, China.  
Tel: (86)0755-26066440 Fax: (86)0755-26014772 Email: service@anbotek.com



Hotline  
400-003-0500  
www.anbotek.com.cn



### 3. Conducted Emission at AC power line

|                   |   |                              |           |
|-------------------|---|------------------------------|-----------|
| Test Requirement: | Refer to 47 CFR 15.207(a), Except as shown in paragraphs (b) and (c) of this section, for an intentional radiator that is designed to be connected to the public utility (AC) power line, the radio frequency voltage that is conducted back onto the AC power line on any frequency or frequencies, within the band 150 kHz to 30 MHz, shall not exceed the limits in the following table, as measured using a 50 $\mu$ H/50 ohms line impedance stabilization network (LISN). |                              |           |
| Test Limit:       | Frequency of emission (MHz)   | Conducted limit (dB $\mu$ V) |           |
|                   |   | Quasi-peak                   | Average   |
|                   | 0.15-0.5  | 66 to 56*                    | 56 to 46* |
|                   | 0.5-5   | 56                           | 46        |
|                   | 5-30  | 60                           | 50        |
|                   | *Decreases with the logarithm of the frequency.   |                              |           |
| Test Method:      | ANSI C63.10-2020 section 6.2  |                              |           |
| Procedure:        | Refer to ANSI C63.10-2020 section 6.2, standard test method for ac power-line conducted emissions from unlicensed wireless devices  |                              |           |

#### 3.1. EUT Operation

|                        |  |
|------------------------|--|
| Operating Environment: |  |
| Test mode:             | 1: TX mode(BLE 1M): Keep the EUT works in continuously transmitting mode (BLE 1M)<br>2: TX mode(BLE 2M): Keep the EUT works in continuously transmitting mode (BLE 2M) |

#### 3.2. Test Setup

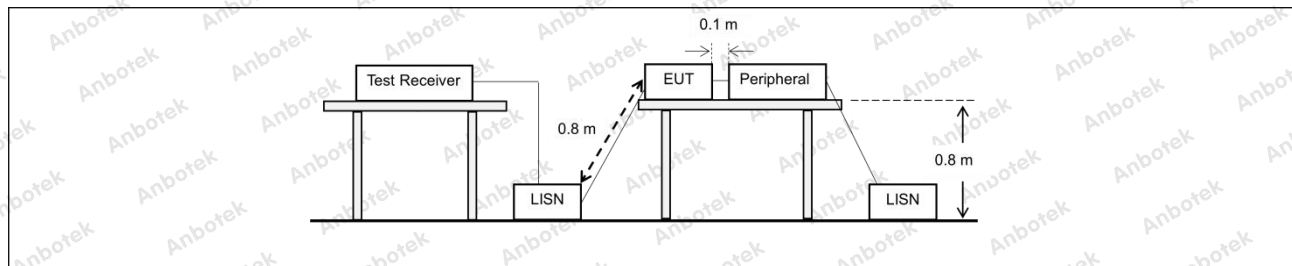

### 3.3. Test Data

|              |         |           |      |                       |         |
|--------------|---------|-----------|------|-----------------------|---------|
| Temperature: | 21.4 °C | Humidity: | 52 % | Atmospheric Pressure: | 101 kPa |
|--------------|---------|-----------|------|-----------------------|---------|

TM2 / Line: Line / Band: 2400-2483.5 MHz / BW: 1 / CH: H

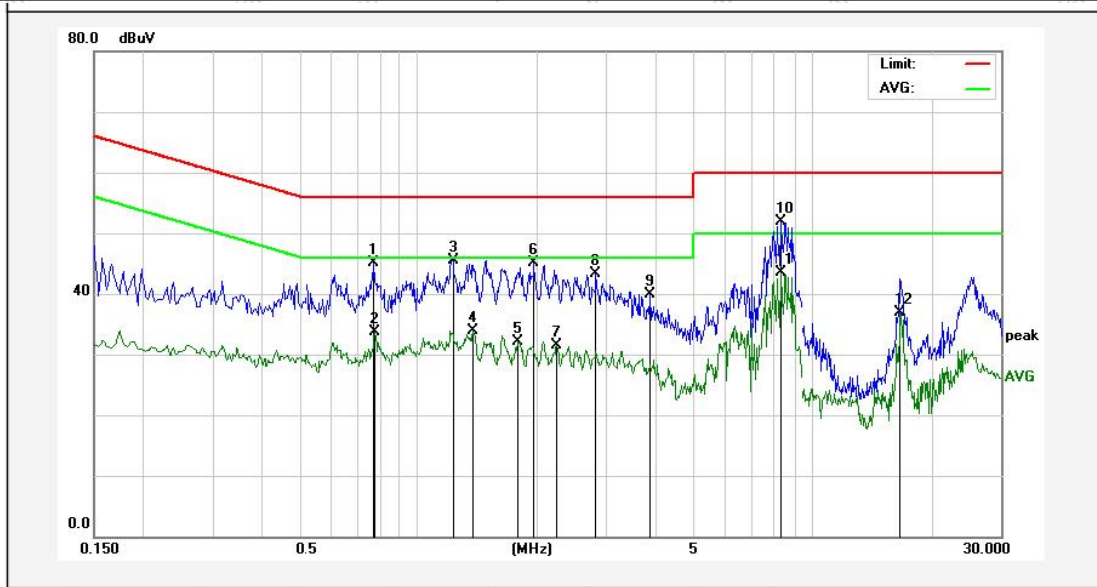

| No. | Freq. (MHz) | Reading (dBUV) | Factor (dB) | Result (dBUV) | Limit (dBUV) | Over Limit (dB) | Detector | Remark |
|-----|-------------|----------------|-------------|---------------|--------------|-----------------|----------|--------|
| 1   | 0.7740      | 27.21          | 17.87       | 45.08         | 56.00        | -10.92          | QP       |        |
| 2   | 0.7780      | 15.90          | 17.86       | 33.76         | 46.00        | -12.24          | AVG      |        |
| 3   | 1.2260      | 27.68          | 17.84       | 45.52         | 56.00        | -10.48          | QP       |        |
| 4   | 1.3779      | 15.99          | 17.84       | 33.83         | 46.00        | -12.17          | AVG      |        |
| 5   | 1.7820      | 14.23          | 17.84       | 32.07         | 46.00        | -13.93          | AVG      |        |
| 6   | 1.9660      | 27.27          | 17.83       | 45.10         | 56.00        | -10.90          | QP       |        |
| 7   | 2.2420      | 13.69          | 17.83       | 31.52         | 46.00        | -14.48          | AVG      |        |
| 8   | 2.8220      | 25.56          | 17.84       | 43.40         | 56.00        | -12.60          | QP       |        |
| 9   | 3.8620      | 22.03          | 17.85       | 39.88         | 56.00        | -16.12          | QP       |        |
| 10  | 8.2819      | 33.92          | 17.92       | 51.84         | 60.00        | -8.16           | QP       |        |
| 11  | 8.2819      | 25.63          | 17.92       | 43.55         | 50.00        | -6.45           | AVG      |        |
| 12  | 16.7219     | 18.78          | 18.22       | 37.00         | 50.00        | -13.00          | AVG      |        |





|              |         |           |      |                       |         |
|--------------|---------|-----------|------|-----------------------|---------|
| Temperature: | 21.4 °C | Humidity: | 52 % | Atmospheric Pressure: | 101 kPa |
|--------------|---------|-----------|------|-----------------------|---------|

TM2 / Line: Neutral / Band: 2400-2483.5 MHz / BW: 1 / CH: H

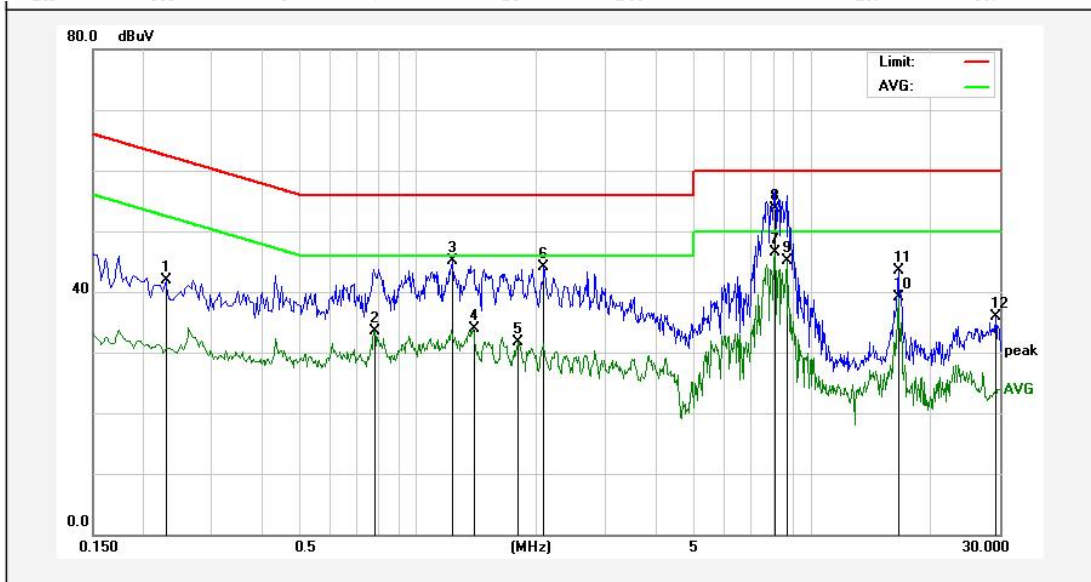

| No. | Freq. (MHz) | Reading (dBuV) | Factor (dB) | Result (dBuV) | Limit (dBuV) | Over Limit (dB) | Detector | Remark |
|-----|-------------|----------------|-------------|---------------|--------------|-----------------|----------|--------|
| 1   | 0.2300      | 24.14          | 17.83       | 41.97         | 62.45        | -20.48          | QP       |        |
| 2   | 0.7820      | 15.73          | 17.86       | 33.59         | 46.00        | -12.41          | AVG      |        |
| 3   | 1.2340      | 27.17          | 17.84       | 45.01         | 56.00        | -10.99          | QP       |        |
| 4   | 1.3860      | 16.07          | 17.84       | 33.91         | 46.00        | -12.09          | AVG      |        |
| 5   | 1.8020      | 13.80          | 17.84       | 31.64         | 46.00        | -14.36          | AVG      |        |
| 6   | 2.0900      | 26.32          | 17.83       | 44.15         | 56.00        | -11.85          | QP       |        |
| 7   | 8.0419      | 28.53          | 17.91       | 46.44         | 50.00        | -3.56           | AVG      |        |
| 8   | 8.0420      | 35.75          | 17.91       | 53.66         | 60.00        | -6.34           | QP       |        |
| 9   | 8.6019      | 27.12          | 17.93       | 45.05         | 50.00        | -4.95           | AVG      |        |
| 10  | 16.5819     | 20.91          | 18.22       | 39.13         | 50.00        | -10.87          | AVG      |        |
| 11  | 16.5820     | 25.36          | 18.22       | 43.58         | 60.00        | -16.42          | QP       |        |
| 12  | 29.3020     | 16.90          | 18.92       | 35.82         | 60.00        | -24.18          | QP       |        |

Note: Only record the worst data in the report.



## 4. Occupied Bandwidth

|                   |  |
|-------------------|--|
| Test Requirement: | 47 CFR 15.247(a)(2)  |
| Test Limit:       | Refer to 47 CFR 15.247(a)(2), Systems using digital modulation techniques may operate in the 902-928 MHz, and 2400-2483.5 MHz bands. The minimum 6 dB bandwidth shall be at least 500 kHz.   |
| Test Method:      | ANSI C63.10-2020, section 11.8<br>KDB 558074 D01 15.247 Meas Guidance v05r02   |
| Procedure:        | <p>11.8.1 Option 1<br/>The steps for the first option are as follows:</p> <ul style="list-style-type: none"> <li>a) Set RBW = shall be in the range of 1% to 5% of the OBW but not less than 100 kHz.</li> <li>b) Set the VBW <math>\geq [3 \times \text{RBW}]</math>.</li> <li>c) Detector = peak.</li> <li>d) Trace mode = max-hold.</li> <li>e) Sweep = No faster than coupled (auto) time.</li> <li>f) Allow the trace to stabilize.</li> <li>g) Measure the maximum width of the emission by placing two markers, one at the lowest frequency and the other at the highest frequency of the envelope of the spectral display, such that each marker is at or slightly below the “-6 dB down amplitude”. If a marker is below this “-6 dB down amplitude” value, then it shall be as close as possible to this value.</li> </ul> <p>11.8.2 Option 2<br/>The automatic bandwidth measurement capability of an instrument may be employed using the X dB bandwidth mode with X set to 6 dB, if the functionality described in 11.8.1 (i.e., RBW = 100 kHz, VBW <math>\geq 3 \times \text{RBW}</math>, and peak detector with maximum hold) is implemented by the instrumentation function.<br/>When using this capability, care shall be taken so that the bandwidth measurement is not influenced by any intermediate power nulls in the fundamental emission that might be <math>\geq 6</math> dB.</p> |

### 4.1. EUT Operation

|                        |   |
|------------------------|---|
| Operating Environment: |   |
| Test mode:             | <p>1: TX mode(BLE 1M): Keep the EUT works in continuously transmitting mode (BLE 1M)</p> <p>2: TX mode(BLE 2M): Keep the EUT works in continuously transmitting mode (BLE 2M)</p> |



## 4.2. Test Setup

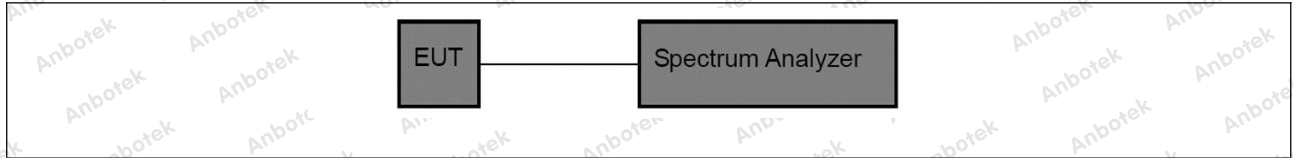

## 4.3. Test Data

|              |         |           |      |                       |         |
|--------------|---------|-----------|------|-----------------------|---------|
| Temperature: | 25.3 °C | Humidity: | 48 % | Atmospheric Pressure: | 101 kPa |
|--------------|---------|-----------|------|-----------------------|---------|

Please Refer to Appendix for Details.





## 5. Maximum Conducted Output Power

|                   |  |
|-------------------|--|
| Test Requirement: | 47 CFR 15.247(b)(3)  |
| Test Limit:       | Refer to 47 CFR 15.247(b)(3), For systems using digital modulation in the 902-928 MHz, 2400-2483.5 MHz, and 5725-5850 MHz bands: 1 Watt. As an alternative to a peak power measurement, compliance with the one Watt limit can be based on a measurement of the maximum conducted output power. Maximum Conducted Output Power is defined as the total transmit power delivered to all antennas and antenna elements averaged across all symbols in the signaling alphabet when the transmitter is operating at its maximum power control level. Power must be summed across all antennas and antenna elements. The average must not include any time intervals during which the transmitter is off or is transmitting at a reduced power level. If multiple modes of operation are possible (e.g., alternative modulation methods), the maximum conducted output power is the highest total transmit power occurring in any mode. |
| Test Method:      | ANSI C63.10-2020 section 11.9.1<br>KDB 558074 D01 15.247 Meas Guidance v05r02  |
| Procedure:        | ANSI C63.10-2020, section 11.9.1 Maximum peak conducted output power   |

### 5.1. EUT Operation

|                        |  |
|------------------------|--|
| Operating Environment: |  |
| Test mode:             | 1: TX mode(BLE 1M): Keep the EUT works in continuously transmitting mode (BLE 1M)<br>2: TX mode(BLE 2M): Keep the EUT works in continuously transmitting mode (BLE 2M) |

### 5.2. Test Setup

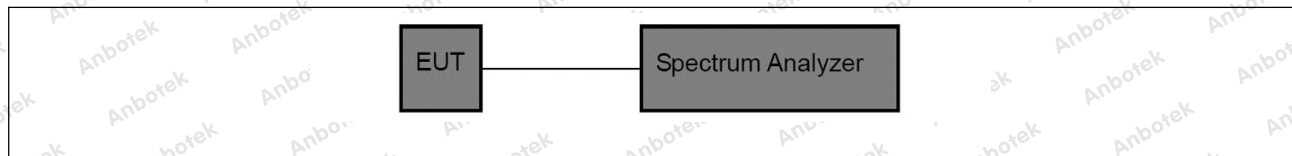

### 5.3. Test Data

|              |         |           |      |                       |         |
|--------------|---------|-----------|------|-----------------------|---------|
| Temperature: | 25.3 °C | Humidity: | 48 % | Atmospheric Pressure: | 101 kPa |
|--------------|---------|-----------|------|-----------------------|---------|

Please Refer to Appendix for Details.



## 6. Power Spectral Density

|                   |   |
|-------------------|---|
| Test Requirement: | 47 CFR 15.247(e)  |
| Test Limit:       | Refer to 47 CFR 15.247(e), For digitally modulated systems, the power spectral density conducted from the intentional radiator to the antenna shall not be greater than 8 dBm in any 3 kHz band during any time interval of continuous transmission. This power spectral density shall be determined in accordance with the provisions of paragraph (b) of this section. The same method of determining the conducted output power shall be used to determine the power spectral density. |
| Test Method:      | ANSI C63.10-2020, section 11.10<br>KDB 558074 D01 15.247 Meas Guidance v05r02   |
| Procedure:        | ANSI C63.10-2020, section 11.10, Maximum power spectral density level in the fundamental emission   |

### 6.1. EUT Operation

|                        |  |
|------------------------|--|
| Operating Environment: |  |
| Test mode:             | 1: TX mode(BLE 1M): Keep the EUT works in continuously transmitting mode (BLE 1M)<br>2: TX mode(BLE 2M): Keep the EUT works in continuously transmitting mode (BLE 2M) |

### 6.2. Test Setup

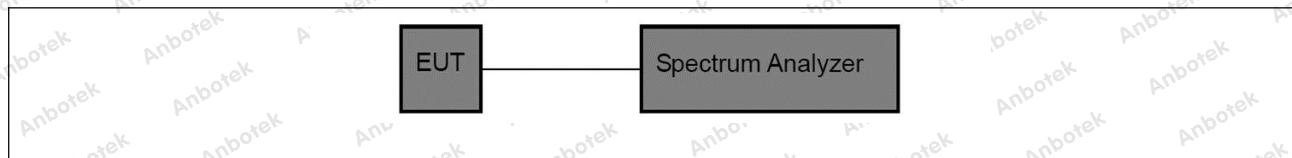

### 6.3. Test Data

|              |         |           |      |                       |         |
|--------------|---------|-----------|------|-----------------------|---------|
| Temperature: | 25.3 °C | Humidity: | 48 % | Atmospheric Pressure: | 101 kPa |
|--------------|---------|-----------|------|-----------------------|---------|

Please Refer to Appendix for Details.



## 7. Emissions in non-restricted frequency bands

|                   |   |
|-------------------|---|
| Test Requirement: | 47 CFR 15.247(d), 15.209, 15.205  |
| Test Limit:       | Refer to 47 CFR 15.247(d), In any 100 kHz bandwidth outside the frequency band in which the spread spectrum or digitally modulated intentional radiator is operating, the radio frequency power that is produced by the intentional radiator shall be at least 20 dB below that in the 100 kHz bandwidth within the band that contains the highest level of the desired power, based on either an RF conducted or a radiated measurement, provided the transmitter demonstrates compliance with the peak conducted power limits. If the transmitter complies with the conducted power limits based on the use of RMS averaging over a time interval, as permitted under paragraph (b)(3) of this section, the attenuation required under this paragraph shall be 30 dB instead of 20 dB. Attenuation below the general limits specified in § 15.209(a) is not required. |
| Test Method:      | ANSI C63.10-2020 section 11.11<br>KDB 558074 D01 15.247 Meas Guidance v05r02  |
| Procedure:        | ANSI C63.10-2020<br>Section 11.11.1, Section 11.11.2, Section 11.11.3   |

### 7.1. EUT Operation

|                        |  |
|------------------------|--|
| Operating Environment: |  |
| Test mode:             | 1: TX mode(BLE 1M): Keep the EUT works in continuously transmitting mode (BLE 1M)<br>2: TX mode(BLE 2M): Keep the EUT works in continuously transmitting mode (BLE 2M) |

### 7.2. Test Setup

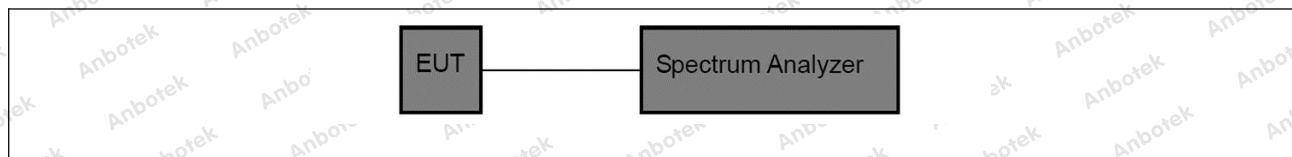

### 7.3. Test Data

|              |         |           |      |                       |         |
|--------------|---------|-----------|------|-----------------------|---------|
| Temperature: | 25.3 °C | Humidity: | 48 % | Atmospheric Pressure: | 101 kPa |
|--------------|---------|-----------|------|-----------------------|---------|

Please Refer to Appendix for Details.





## 8. Band edge emissions (Radiated)

|                   |  |                                   |                               |
|-------------------|--|-----------------------------------|-------------------------------|
| Test Requirement: | Refer to 47 CFR 15.247(d), In addition, radiated emissions which fall in the restricted bands, as defined in § 15.205(a), must also comply with the radiated emission limits specified in § 15.209(a)(see § 15.205(c)).` |                                   |                               |
| Test Limit:       | Frequency (MHz)  | Field strength (microvolts/meter) | Measurement distance (meters) |
|                   | 0.009-0.490  | 2400/F(kHz)                       | 300                           |
|                   | 0.490-1.705  | 24000/F(kHz)                      | 30                            |
|                   | 1.705-30.0   | 30                                | 30                            |
|                   | 30-88  | 100 **                            | 3                             |
|                   | 88-216   | 150 **                            | 3                             |
|                   | 216-960  | 200 **                            | 3                             |
|                   | Above 960  | 500                               | 3                             |
| Test Method:      | ANSI C63.10-2020 section 6.10<br>KDB 558074 D01 15.247 Meas Guidance v05r02  |                                   |                               |
| Procedure:        | ANSI C63.10-2020 section 6.10.5.2  |                                   |                               |

\*\* Except as provided in paragraph (g), fundamental emissions from intentional radiators operating under this section shall not be located in the frequency bands 54-72 MHz, 76-88 MHz, 174-216 MHz or 470-806 MHz. However, operation within these frequency bands is permitted under other sections of this part, e.g., §§ 15.231 and 15.241. In the emission table above, the tighter limit applies at the band edges. The emission limits shown in the above table are based on measurements employing a CISPR quasi-peak detector except for the frequency bands 9–90 kHz, 110–490 kHz and above 1000 MHz. Radiated emission limits in these three bands are based on measurements employing an average detector.

### 8.1. EUT Operation

|                        |  |
|------------------------|--|
| Operating Environment: |  |
| Test mode:             | 1: TX mode(BLE 1M): Keep the EUT works in continuously transmitting mode (BLE 1M)<br>2: TX mode(BLE 2M): Keep the EUT works in continuously transmitting mode (BLE 2M) |



## 8.2. Test Setup

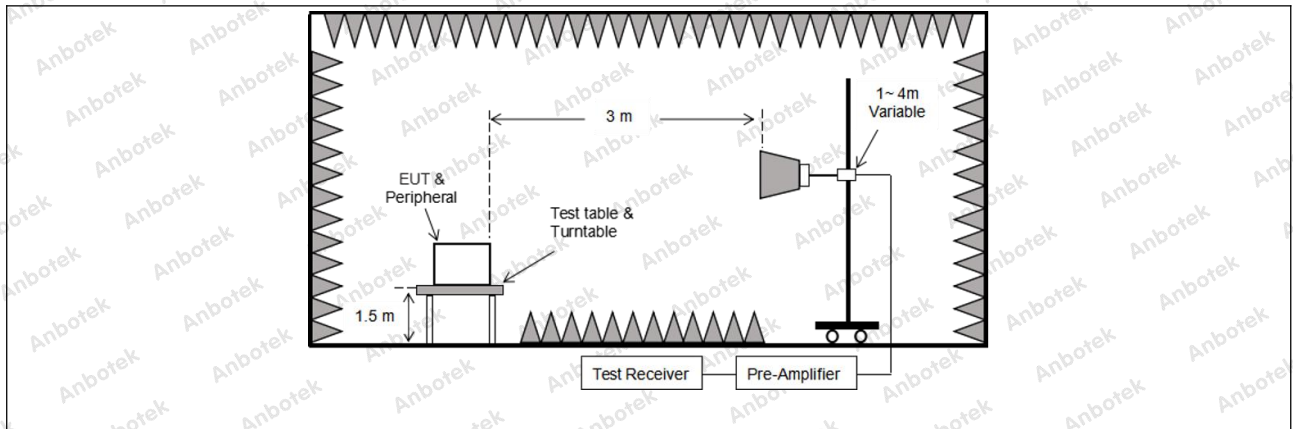

### Shenzhen Anbotek Compliance Laboratory Limited

Address: 1/F., Building D, Sogood Science and Technology Park, Sanwei Community, Hangcheng Street, Bao'an District, Shenzhen, Guangdong, China.  
Tel: (86)0755-26066440 Fax: (86)0755-26014772 Email: service@anbotek.com



Hotline  
400-003-0500  
www.anbotek.com.cn



### 8.3. Test Data

|              |         |           |      |                       |         |
|--------------|---------|-----------|------|-----------------------|---------|
| Temperature: | 25.3 °C | Humidity: | 48 % | Atmospheric Pressure: | 101 kPa |
|--------------|---------|-----------|------|-----------------------|---------|

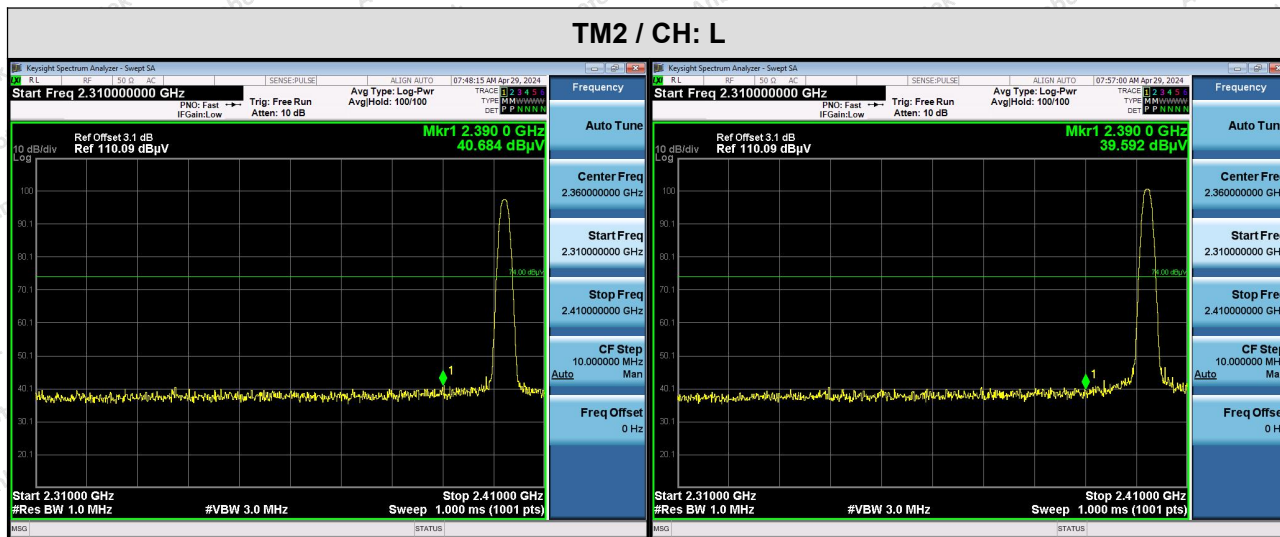

Peak Value(Vertical)

Peak Value(Horizontal)

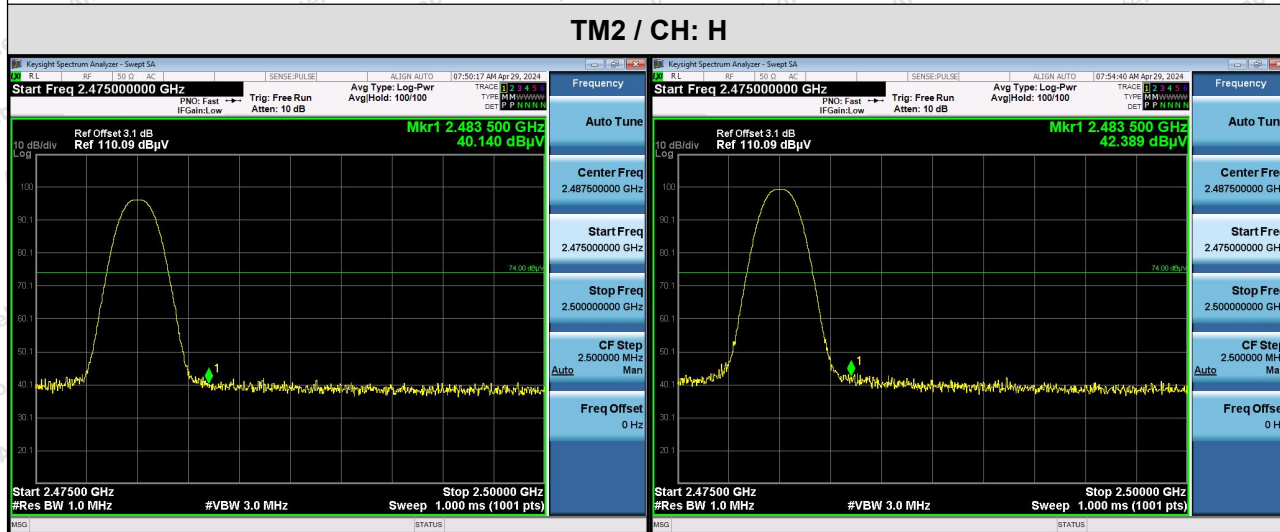

Peak Value(Vertical)

Peak Value(Horizontal)

**Remark:**

1. When the PK measure result value is less than the AVG limit value, the AV measure result values test not applicable.
2. During the test, pre-scan all modes, the report only record the worse case mode.





## 9. Emissions in frequency bands (below 1GHz)

|                   |  |                                   |                               |
|-------------------|--|-----------------------------------|-------------------------------|
| Test Requirement: | Refer to 47 CFR 15.247(d), In addition, radiated emissions which fall in the restricted bands, as defined in § 15.205(a), must also comply with the radiated emission limits specified in § 15.209(a)(see § 15.205(c)).`   |                                   |                               |
| Test Limit:       | Frequency (MHz)  | Field strength (microvolts/meter) | Measurement distance (meters) |
|                   | 0.009-0.490  | 2400/F(kHz)                       | 300                           |
|                   | 0.490-1.705  | 24000/F(kHz)                      | 30                            |
|                   | 1.705-30.0   | 30                                | 30                            |
|                   | 30-88  | 100 **                            | 3                             |
|                   | 88-216   | 150 **                            | 3                             |
|                   | 216-960  | 200 **                            | 3                             |
|                   | Above 960  | 500                               | 3                             |
| Test Method:      | <p>** Except as provided in paragraph (g), fundamental emissions from intentional radiators operating under this section shall not be located in the frequency bands 54-72 MHz, 76-88 MHz, 174-216 MHz or 470-806 MHz. However, operation within these frequency bands is permitted under other sections of this part, e.g., §§ 15.231 and 15.241.</p> <p>In the emission table above, the tighter limit applies at the band edges. The emission limits shown in the above table are based on measurements employing a CISPR quasi-peak detector except for the frequency bands 9–90 kHz, 110–490 kHz and above 1000 MHz. Radiated emission limits in these three bands are based on measurements employing an average detector.</p> |                                   |                               |
| Procedure:        | ANSI C63.10-2020 section 6.6.4   |                                   |                               |

### 9.1. EUT Operation

|                        |   |
|------------------------|---|
| Operating Environment: |   |
| Test mode:             | <p>1: TX mode(BLE 1M): Keep the EUT works in continuously transmitting mode (BLE 1M)</p> <p>2: TX mode(BLE 2M): Keep the EUT works in continuously transmitting mode (BLE 2M)</p> |



## 9.2. Test Setup

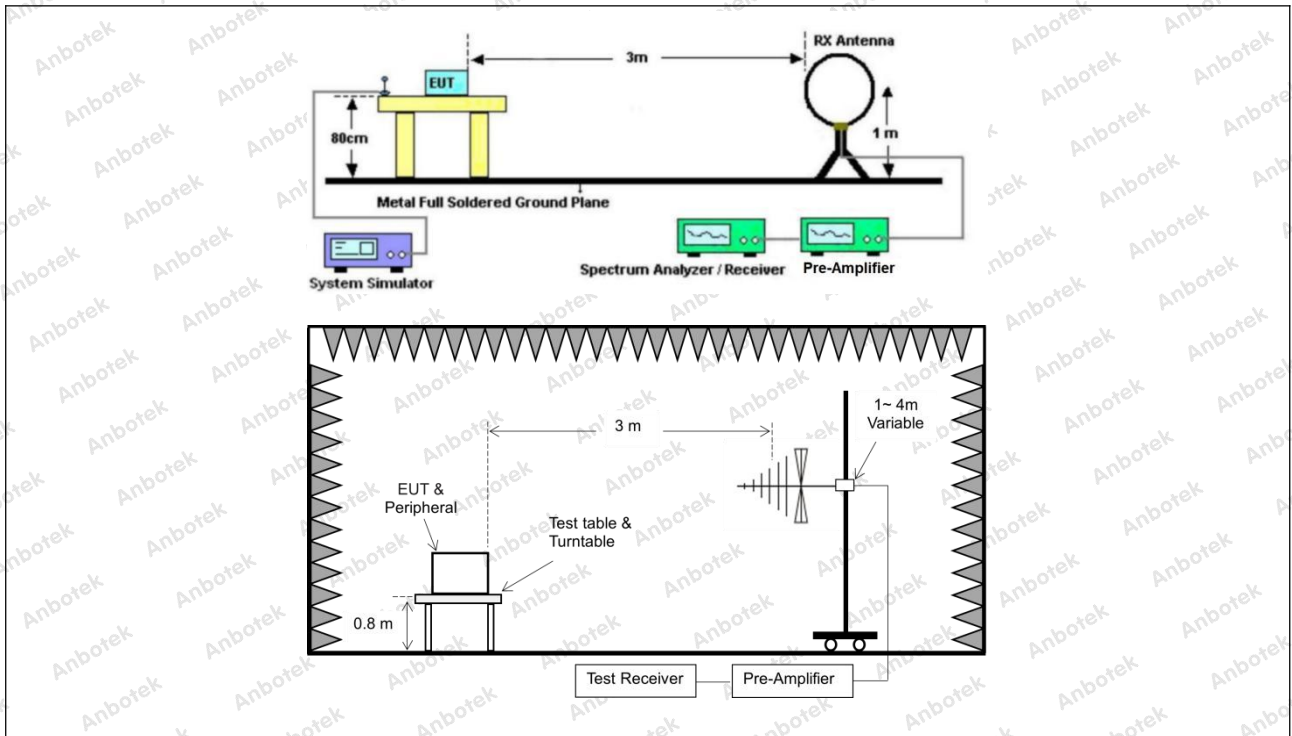

### 9.3. Test Data

The test results of 9kHz-30MHz was attenuated more than 20dB below the permissible limits, so the results don't record in the report.

|              |         |           |      |                       |         |
|--------------|---------|-----------|------|-----------------------|---------|
| Temperature: | 20.3 °C | Humidity: | 46 % | Atmospheric Pressure: | 101 kPa |
|--------------|---------|-----------|------|-----------------------|---------|

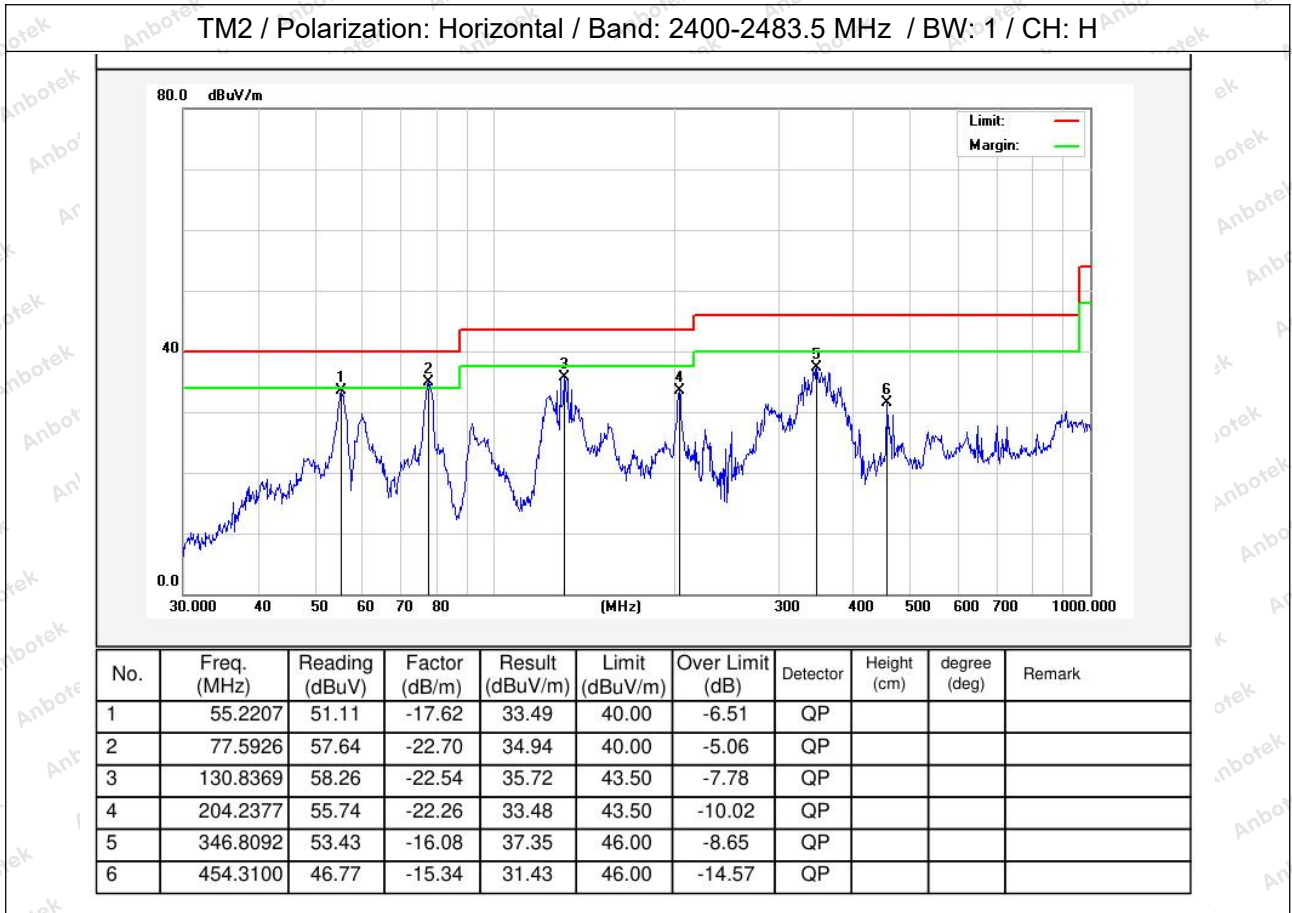



|              |         |           |      |                       |         |
|--------------|---------|-----------|------|-----------------------|---------|
| Temperature: | 20.3 °C | Humidity: | 46 % | Atmospheric Pressure: | 101 kPa |
|--------------|---------|-----------|------|-----------------------|---------|

TM2 / Polarization: Vertical / Band: 2400-2483.5 MHz / BW: 1 / CH: H

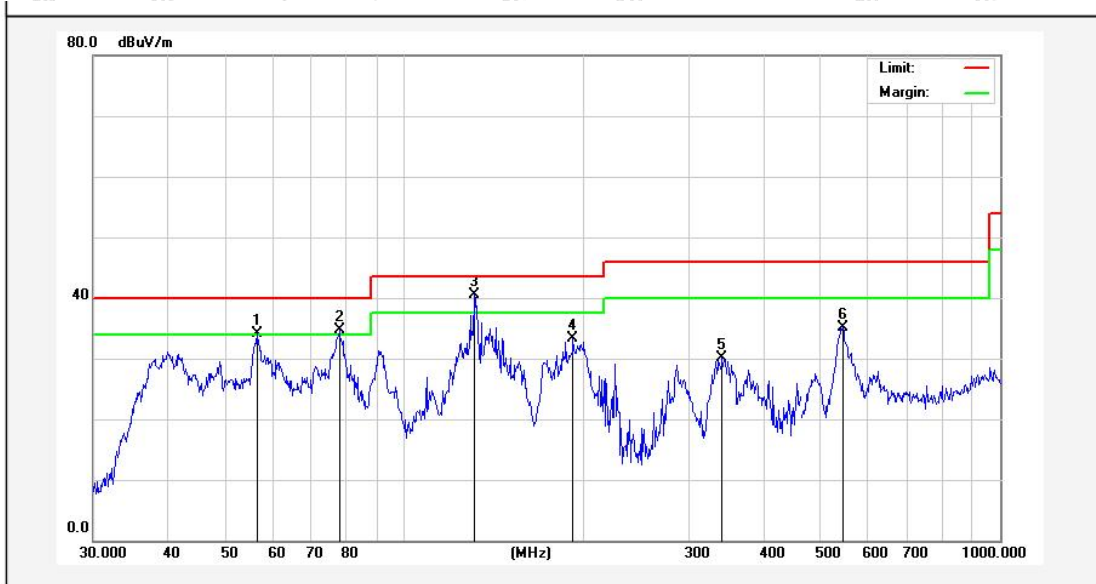

| No. | Freq. (MHz) | Reading (dBUV) | Factor (dB/m) | Result (dBUV/m) | Limit (dBUV/m) | Over Limit (dB) | Detector | Height (cm) | degree (deg) | Remark |
|-----|-------------|----------------|---------------|-----------------|----------------|-----------------|----------|-------------|--------------|--------|
| 1   | 56.3947     | 51.71          | -17.59        | 34.12           | 40.00          | -5.88           | QP       |             |              |        |
| 2   | 77.8653     | 54.33          | -19.55        | 34.78           | 40.00          | -5.22           | QP       |             |              |        |
| 3   | 130.8369    | 62.02          | -21.52        | 40.50           | 43.50          | -3.00           | QP       |             |              |        |
| 4   | 191.7450    | 53.36          | -20.05        | 33.31           | 43.50          | -10.19          | QP       |             |              |        |
| 5   | 340.7817    | 45.36          | -15.22        | 30.14           | 46.00          | -15.86          | QP       |             |              |        |
| 6   | 545.1826    | 46.82          | -11.81        | 35.01           | 46.00          | -10.99          | QP       |             |              |        |

Note: Only record the worst data in the report.



## 10. Emissions in frequency bands (above 1GHz)

|                   |  |                                   |                               |
|-------------------|--|-----------------------------------|-------------------------------|
| Test Requirement: | In addition, radiated emissions which fall in the restricted bands, as defined in § 15.205(a), must also comply with the radiated emission limits specified in § 15.209(a)(see § 15.205(c)).   |                                   |                               |
| Test Limit:       | Frequency (MHz)  | Field strength (microvolts/meter) | Measurement distance (meters) |
|                   | 0.009-0.490  | 2400/F(kHz)                       | 300                           |
|                   | 0.490-1.705  | 24000/F(kHz)                      | 30                            |
|                   | 1.705-30.0   | 30                                | 30                            |
|                   | 30-88  | 100 **                            | 3                             |
|                   | 88-216   | 150 **                            | 3                             |
|                   | 216-960  | 200 **                            | 3                             |
|                   | Above 960  | 500                               | 3                             |
|                   | ** Except as provided in paragraph (g), fundamental emissions from intentional radiators operating under this section shall not be located in the frequency bands 54-72 MHz, 76-88 MHz, 174-216 MHz or 470-806 MHz. However, operation within these frequency bands is permitted under other sections of this part, e.g., §§ 15.231 and 15.241. In the emission table above, the tighter limit applies at the band edges. The emission limits shown in the above table are based on measurements employing a CISPR quasi-peak detector except for the frequency bands 9–90 kHz, 110–490 kHz and above 1000 MHz. Radiated emission limits in these three bands are based on measurements employing an average detector. |                                   |                               |
| Test Method:      | ANSI C63.10-2020 section 6.6.4<br>KDB 558074 D01 15.247 Meas Guidance v05r02   |                                   |                               |
| Procedure:        | ANSI C63.10-2020 section 6.6.4   |                                   |                               |

### 10.1. EUT Operation

|                        |  |
|------------------------|--|
| Operating Environment: |  |
| Test mode:             | 1: TX mode(BLE 1M): Keep the EUT works in continuously transmitting mode (BLE 1M)<br>2: TX mode(BLE 2M): Keep the EUT works in continuously transmitting mode (BLE 2M) |



## 10.2. Test Setup

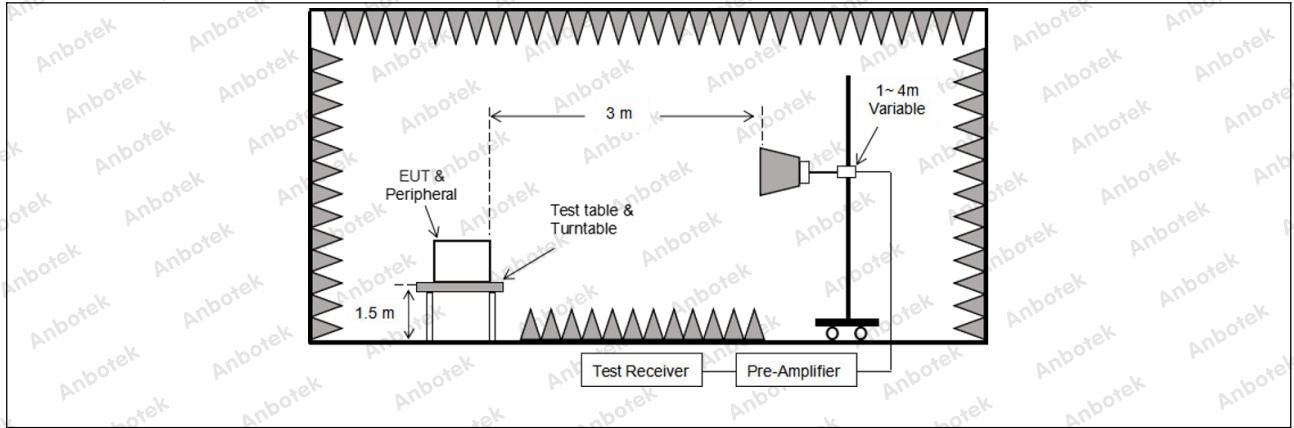

### Shenzhen Anbotek Compliance Laboratory Limited

Address: 1/F., Building D, Sogood Science and Technology Park, Sanwei Community, Hangcheng Street, Bao'an District, Shenzhen, Guangdong, China.  
Tel: (86)0755-26066440 Fax: (86)0755-26014772 Email: service@anbotek.com



Hotline  
400-003-0500  
www.anbotek.com.cn





### 10.3. Test Data

|              |         |           |      |                       |         |
|--------------|---------|-----------|------|-----------------------|---------|
| Temperature: | 20.3 °C | Humidity: | 46 % | Atmospheric Pressure: | 101 kPa |
|--------------|---------|-----------|------|-----------------------|---------|

| TM2 / CH: L     |                |               |                 |                |                 |              |
|-----------------|----------------|---------------|-----------------|----------------|-----------------|--------------|
| Peak value:     |                |               |                 |                |                 |              |
| Frequency (MHz) | Reading (dBuV) | Factor (dB/m) | Result (dBuV/m) | Limit (dBuV/m) | Over Limit (dB) | polarization |
| 4804.00         | 28.91          | 15.27         | 44.18           | 74.00          | -29.82          | Vertical     |
| 7206.00         | 28.90          | 18.09         | 46.99           | 74.00          | -27.01          | Vertical     |
| 9608.00         | 29.90          | 23.76         | 53.66           | 74.00          | -20.34          | Vertical     |
| 12010.00        | *              |               |                 | 74.00          |                 | Vertical     |
| 14412.00        | *              |               |                 | 74.00          |                 | Vertical     |
| 4804.00         | 28.54          | 15.27         | 43.81           | 74.00          | -30.19          | Horizontal   |
| 7206.00         | 29.59          | 18.09         | 47.68           | 74.00          | -26.32          | Horizontal   |
| 9608.00         | 28.31          | 23.76         | 52.07           | 74.00          | -21.93          | Horizontal   |
| 12010.00        | *              |               |                 | 74.00          |                 | Horizontal   |
| 14412.00        | *              |               |                 | 74.00          |                 | Horizontal   |
| Average value:  |                |               |                 |                |                 |              |
| Frequency (MHz) | Reading (dBuV) | Factor (dB/m) | Result (dBuV/m) | Limit (dBuV/m) | Over Limit (dB) | polarization |
| 4804.00         | 17.18          | 15.27         | 32.45           | 54.00          | -21.55          | Vertical     |
| 7206.00         | 17.95          | 18.09         | 36.04           | 54.00          | -17.96          | Vertical     |
| 9608.00         | 19.37          | 23.76         | 43.13           | 54.00          | -10.87          | Vertical     |
| 12010.00        | *              |               |                 | 54.00          |                 | Vertical     |
| 14412.00        | *              |               |                 | 54.00          |                 | Vertical     |
| 4804.00         | 16.87          | 15.27         | 32.14           | 54.00          | -21.86          | Horizontal   |
| 7206.00         | 18.62          | 18.09         | 36.71           | 54.00          | -17.29          | Horizontal   |
| 9608.00         | 17.82          | 23.76         | 41.58           | 54.00          | -12.42          | Horizontal   |
| 12010.00        | *              |               |                 | 54.00          |                 | Horizontal   |
| 14412.00        | *              |               |                 | 54.00          |                 | Horizontal   |

#### Shenzhen Anbotek Compliance Laboratory Limited

Address: 1/F., Building D, Sogood Science and Technology Park, Sanwei Community, Hangcheng Street, Bao'an District, Shenzhen, Guangdong, China.  
 Tel: (86)0755-26066440 Fax: (86)0755-26014772 Email: service@anbotek.com



Hotline  
 400-003-0500  
[www.anbotek.com.cn](http://www.anbotek.com.cn)



| TM2 / CH: M     |                |               |                 |                |                 |              |
|-----------------|----------------|---------------|-----------------|----------------|-----------------|--------------|
| Peak value:     |                |               |                 |                |                 |              |
| Frequency (MHz) | Reading (dBuV) | Factor (dB/m) | Result (dBuV/m) | Limit (dBuV/m) | Over Limit (dB) | polarization |
| 4880.00         | 28.46          | 15.42         | 43.88           | 74.00          | -30.12          | Vertical     |
| 7320.00         | 28.87          | 18.02         | 46.89           | 74.00          | -27.11          | Vertical     |
| 9760.00         | 29.40          | 23.80         | 53.20           | 74.00          | -20.80          | Vertical     |
| 12200.00        | *              |               |                 | 74.00          |                 | Vertical     |
| 14640.00        | *              |               |                 | 74.00          |                 | Vertical     |
| 4880.00         | 28.35          | 15.42         | 43.77           | 74.00          | -30.23          | Horizontal   |
| 7320.00         | 29.46          | 18.02         | 47.48           | 74.00          | -26.52          | Horizontal   |
| 9760.00         | 28.03          | 23.80         | 51.83           | 74.00          | -22.17          | Horizontal   |
| 12200.00        | *              |               |                 | 74.00          |                 | Horizontal   |
| 14640.00        | *              |               |                 | 74.00          |                 | Horizontal   |
| Average value:  |                |               |                 |                |                 |              |
| Frequency (MHz) | Reading (dBuV) | Factor (dB/m) | Result (dBuV/m) | Limit (dBuV/m) | Over Limit (dB) | polarization |
| 4880.00         | 17.27          | 15.42         | 32.69           | 54.00          | -21.31          | Vertical     |
| 7320.00         | 17.81          | 18.02         | 35.83           | 54.00          | -18.17          | Vertical     |
| 9760.00         | 19.22          | 23.80         | 43.02           | 54.00          | -10.98          | Vertical     |
| 12200.00        | *              |               |                 | 54.00          |                 | Vertical     |
| 14640.00        | *              |               |                 | 54.00          |                 | Vertical     |
| 4880.00         | 16.98          | 15.42         | 32.40           | 54.00          | -21.60          | Horizontal   |
| 7320.00         | 18.97          | 18.02         | 36.99           | 54.00          | -17.01          | Horizontal   |
| 9760.00         | 18.12          | 23.80         | 41.92           | 54.00          | -12.08          | Horizontal   |
| 12200.00        | *              |               |                 | 54.00          |                 | Horizontal   |
| 14640.00        | *              |               |                 | 54.00          |                 | Horizontal   |

**Shenzhen Anbotek Compliance Laboratory Limited**

Address: 1/F., Building D, Sogood Science and Technology Park, Sanwei Community, Hangcheng Street, Bao'an District, Shenzhen, Guangdong, China.  
 Tel: (86)0755-26066440 Fax: (86)0755-26014772 Email: service@anbotek.com



Hotline  
 400-003-0500  
[www.anbotek.com.cn](http://www.anbotek.com.cn)



| TM2 / CH: H     |                |               |                 |                |                 |              |
|-----------------|----------------|---------------|-----------------|----------------|-----------------|--------------|
| Peak value:     |                |               |                 |                |                 |              |
| Frequency (MHz) | Reading (dBuV) | Factor (dB/m) | Result (dBuV/m) | Limit (dBuV/m) | Over Limit (dB) | polarization |
| 4960.00         | 28.59          | 15.58         | 44.17           | 74.00          | -29.83          | Vertical     |
| 7440.00         | 29.03          | 17.93         | 46.96           | 74.00          | -27.04          | Vertical     |
| 9920.00         | 30.10          | 23.83         | 53.93           | 74.00          | -20.07          | Vertical     |
| 12400.00        | *              |               |                 | 74.00          |                 | Vertical     |
| 14880.00        | *              |               |                 | 74.00          |                 | Vertical     |
| 4960.00         | 28.49          | 15.58         | 44.07           | 74.00          | -29.93          | Horizontal   |
| 7440.00         | 29.67          | 17.93         | 47.60           | 74.00          | -26.40          | Horizontal   |
| 9920.00         | 28.41          | 23.83         | 52.24           | 74.00          | -21.76          | Horizontal   |
| 12400.00        | *              |               |                 | 74.00          |                 | Horizontal   |
| 14880.00        | *              |               |                 | 74.00          |                 | Horizontal   |
| Average value:  |                |               |                 |                |                 |              |
| Frequency (MHz) | Reading (dBuV) | Factor (dB/m) | Result (dBuV/m) | Limit (dBuV/m) | Over Limit (dB) | polarization |
| 4960.00         | 18.39          | 15.58         | 33.97           | 54.00          | -20.03          | Vertical     |
| 7440.00         | 19.08          | 17.93         | 37.01           | 54.00          | -16.99          | Vertical     |
| 9920.00         | 19.87          | 23.83         | 43.70           | 54.00          | -10.30          | Vertical     |
| 12400.00        | *              |               |                 | 54.00          |                 | Vertical     |
| 14880.00        | *              |               |                 | 54.00          |                 | Vertical     |
| 4960.00         | 18.16          | 15.58         | 33.74           | 54.00          | -20.26          | Horizontal   |
| 7440.00         | 19.77          | 17.93         | 37.70           | 54.00          | -16.30          | Horizontal   |
| 9920.00         | 18.27          | 23.83         | 42.10           | 54.00          | -11.90          | Horizontal   |
| 12400.00        | *              |               |                 | 54.00          |                 | Horizontal   |
| 14880.00        | *              |               |                 | 54.00          |                 | Horizontal   |

**Remark:**

1. Result = Reading + Factor
2. “\*” means the test results were attenuated more than 20dB below the permissible limits, so the results don't record in the report.
3. Only the worst case is recorded in the report.

**Shenzhen Anbotek Compliance Laboratory Limited**

Address: 1/F., Building D, Sogood Science and Technology Park, Sanwei Community, Hangcheng Street, Bao'an District, Shenzhen, Guangdong, China.  
 Tel: (86)0755-26066440 Fax: (86)0755-26014772 Email: service@anbotek.com



Hotline  
 400-003-0500  
 www.anbotek.com.cn





**APPENDIX I -- TEST SETUP PHOTOGRAPH**

Please refer to separated files Appendix I -- Test Setup Photograph

**APPENDIX II -- EXTERNAL PHOTOGRAPH**

Please refer to separated files Appendix II -- External Photograph

**APPENDIX III -- INTERNAL PHOTOGRAPH**

Please refer to separated files Appendix III -- Internal Photograph

----- End of Report -----

**Shenzhen Anbotek Compliance Laboratory Limited**

Address: 1/F., Building D, Sogood Science and Technology Park, Sanwei Community,  
Hangcheng Street, Bao'an District, Shenzhen, Guangdong, China.  
Tel: (86)0755-26066440 Fax: (86)0755-26014772 Email: service@anbotek.com



Hotline  
400-003-0500  
www.anbotek.com.cn

