

## FCC RADIO TEST REPORT

Applicant..... : Eastway (Shanghai) Co., Ltd.  
Address..... : Room 3255, Block 1, No. 1017 Caoyang Rd., Putuo District, Shanghai  
Manufacturer..... : Eastway (Shanghai) Co., Ltd.  
Address..... : Room 3255, Block 1, No. 1017 Caoyang Rd., Putuo District, Shanghai  
Factory..... : Dongguan IRice Electronics Development Co.,Ltd.  
Address..... : Building 1, No.17, Hudie 1st Road, Tianxin village, Huangjiang town,  
Dongguan city, Guangdong province, PRC 523763 China  
Product Name..... : Power Station  
Brand Name..... : HEATCURE  
Model No. .... : HEATCURE 400  
FCC ID..... : 2A2Y7-HEATCURE400  
Measurement Standard..... : 47 CFR FCC Part 15, Subpart C  
Receipt Date of Samples.... : August 06, 2021  
Date of Tested..... : August 14, 2021 to September 05, 2021  
Date of Report..... : September 16, 2021

This report shows that above equipment is technically compliant with the requirements of the standards above. All test results in this report apply only to the tested sample(s). Without prior written approval of Dongguan Nore Testing Center Co., Ltd, this report shall not be reproduced except in full.

  
Prepared by  
Jenny Liu / Project Engineer

  
Approved by  
Iori Fan / Authorized Signatory

## Table of Contents

1. Summary of Test Result .....	4
2. General Description of EUT.....	5
3. Test Channels and Modes Detail .....	6
4. Configuration of EUT .....	6
5. Modification of EUT .....	7
6. Description of Support Device .....	8
7. Test Facility and Location.....	8
8. Applicable Standards and References .....	9
9. Deviations and Abnormalities from Standard Conditions .....	9
10. Test Conditions .....	9
11. Measurement Uncertainty .....	10
12. Sample Calculations.....	11
13. Test Items and Results.....	12
13.1 Conducted Emissions Measurement.....	12
13.2 Radiated Spurious Emissions and Restricted Bands Measurement.....	16
13.3 20dB Bandwidth Measurement.....	26
13.4 Antenna Requirement.....	28
14. Test Equipment List.....	29

**Revision History**

<b>Report Number</b>	<b>Description</b>	<b>Issued Date</b>
NTC2108109FV00	Initial Issue	2021-09-16

## 1. Summary of Test Result

FCC Rules	Description of Test	Result	Remarks
§15.207 (a)	AC Power Conducted Emission	PASS	---
§15.209	Radiated Emissions	PASS	---
§15.35	20dB Bandwidth	PASS	---

## 2. General Description of EUT

Product Information	
Product Name:	Power Station
Main Model Name:	HEATCURE 400
Additional Model Name:	N/A
Model Difference:	N/A
S/N:	N/A
Brand Name:	HEATCURE
Hardware Version:	Not Stated
Software Version:	1.9
Rating:	DC 14.8V come from internal battery DC Input: DC19V 3.42A (65W Max), come from Adapter Type-C1: DC5V 3A/DC9V 3A/DC12V 3A/DC15V 3A/DC20V 3A (60W Max), AC Output: AC105V-120V, 60Hz (300W Max), DC Output: Type-C1: DC5V 3A/DC9V 3A/DC12V 3A/DC15V 3A/DC20V 3A (60W Max), Type-C2: DC5V 3A/DC9V 2A/DC12V 1.5A (18W Max), USB1&USB2: DC5V 3A/DC9V 2A/DC12V 1.5A(QC 3.0) (Total DC5V 3A), USB3&USB4: DC5V 2.4A (Total DC5V 3A), Car Charger: DC12V 10A (120W Max), Wireless output 1&2: 5W/7.5W/10W
Typical Arrangement:	Tabletop
I/O Port:	Reference manual
Accessories Information	
Adapter:	Model: FJ-SW20171903420D Input: AC100-240V, 50/60Hz, 1.5A Max. Output: DC19V 3.42A, 64.98W
Cable:	USB-C Cable: 1.05m, shielded, detachable, Adapter AC Cable:1.02m, unshielded, detachable, Adapter DC Cable:1.02m, unshielded, non-detachable with one core.
Other:	N/A
Additional Information	
Note:	N/A
Remark:	All the information above are provided by the manufacturer. More detailed feature of the EUT please refers to the user manual.

Technical Specification	
Frequency Range:	110.5-210KHz
Modulation Type:	FSK
Antenna Type:	Coil antenna

### 3. Test Channels and Modes Detail

Mode		Modulation
1	1 wireless charging (5W)+ Transmitting	FSK
2	1 wireless charging (10W)+ Transmitting	
3	2 wireless charging (5W)+ Transmitting	
4	2 wireless charging (10W)+ Transmitting	
5	1+2 wireless charging (5W)+ Transmitting	
6	1+2 wireless charging (10W)+ Transmitting	

Remarks: 1 is the first wireless charger base,  
2 is the second wireless charger base

### 4. Configuration of EUT

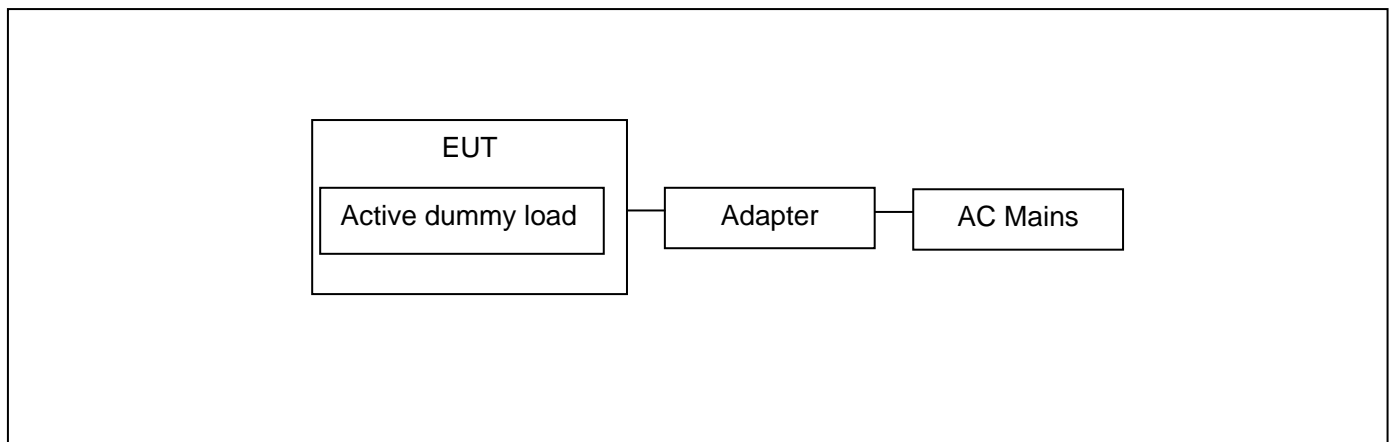

## **5. Modification of EUT**

No modifications are made to the EUT during all test items.

## 6. Description of Support Device

The EUT has been tested as an independent unit together with other necessary accessories or support units. The following support units or accessories were used to form a representative test configuration during the tests.

No.	Equipment	Brand	M/N	S/N	Cable Specification	Remarks
1.	Active dummy load	---	---	---	---	---

## 7. Test Facility and Location

Test Site	:	Dongguan Nore Testing Center Co., Ltd. (Dongguan NTC Co., Ltd.)
Accreditations and Authorizations	:	<p>The Laboratory has been assessed and proved to be in compliance with CNAS/CL01 Listed by CNAS, August 13, 2018 The Certificate Registration Number is L5795. The Certificate is valid until August 13, 2024</p> <p>The Laboratory has been assessed and proved to be in compliance with ISO17025 Listed by A2LA, November 01, 2017 The Certificate Registration Number is 4429.01 The Certificate is valid until December 31, 2021</p> <p>Listed by FCC, November 06, 2017 Test Firm Registration Number is 907417</p> <p>Listed by Industry Canada, June 08, 2017 The Certificate Registration Number is 46405-9743A The CAB identifier number is CN0015</p>
Test Site Location	:	Building D, Gaosheng Science and Technology Park, Hongtu Road, Nancheng District, Dongguan City, Guangdong Province, China



## 8. Applicable Standards and References

According to the specifications of the manufacturer, the EUT must comply with the requirements of the following standards:

### Test Standards:

47 CFR Part 15, Subpart C

ANSI C63.10-2013

### References Test Guidance:

N/A

## 9. Deviations and Abnormalities from Standard Conditions

No additions, deviations and exclusions from the standard.

## 10. Test Conditions

No.	Test Item	Test Mode	Test Voltage	Tested by	Remarks
1.	AC Power Conducted Emission	1	AC 120V 60Hz AC 240V 50Hz	Sean Yuan	See note 1
2.	Radiated Emissions	1	AC 120V 60Hz AC 240V 50Hz	Sean Yuan	See note 1
3.	20dB Bandwidth	1	AC 120V 60Hz AC 240V 50Hz	Sean Yuan	See note 1

### Note:

- The testing climatic conditions for temperature, humidity, and atmospheric pressure are within: 15~35°C, 30~70%, 86~106kPa.
- For the test voltage, only the worst case was recorded in this report.

## 11. Measurement Uncertainty

No.	Test Item	Frequency	Uncertainty	Remarks
1.	Conducted Emission	150KHz ~ 30MHz	±2.52 dB	---
2.	Radiated Emission Test	9kHz ~ 30MHz	±2.60 dB	---
		30MHz ~ 1GHz	±4.68 dB	---
		1GHz ~ 18GHz	±5.14 dB	---
		18GHz ~ 40GHz	±5.14 dB	---
3.	RF Conducted Test	10Hz ~ 40GHz	±1.06 dB	---

**Note:**

1. This uncertainty represents an expanded uncertainty expressed at approximately the 95% confidence level using a coverage factor of k=2.
2. The measurement uncertainty levels above are estimated and calculated according to CISPR 16-4-2.
3. The conformity assessment statement in this report is based solely on the test results, measurement uncertainty is excluded.

## 12. Sample Calculations

Conducted Emission						
Freq. (MHz)	Reading Level (dBuV)	Correct Factor (dB)	Measurement (dBuV)	Limit (dBuV)	Over (dB)	Detector
0.1900	30.10	10.60	40.70	79.00	-38.30	QP

Where,

Freq. = Emission frequency in MHz  
 Reading Level = Uncorrected Analyzer/Receiver reading  
 Corrector Factor = Insertion loss of LISN + Cable Loss + RF Switching Unit attenuation  
 Measurement = Reading + Corrector Factor  
 Limit = Limit stated in standard  
 Margin = Measurement - Limit  
 Detector = Reading for Quasi-Peak / Average / Peak

Radiated Spurious Emissions and Restricted Bands						
Freq. (MHz)	Reading Level (dBuV)	Correct Factor (dB/m)	Measurement (dBuV/m)	Limit (dBuV/m)	Over (dB)	Detector
60.0700	45.88	-18.38	27.50	49.00	-21.50	QP

Where,

Freq. = Emission frequency in MHz  
 Reading Level = Uncorrected Analyzer/Receiver reading  
 Corrector Factor = Antenna Factor + Cable Loss - Pre-amplifier  
 Measurement = Reading + Corrector Factor  
 Limit = Limit stated in standard  
 Over = Margin, which calculated by Measurement - Limit  
 Detector = Reading for Quasi-Peak / Average / Peak

Note: For all conducted test items, the spectrum analyzer offset or transducer is derived from RF cable loss and attenuator factor. The offset or transducer is equal to the RF cable loss plus attenuator factor.

### 13. Test Items and Results

#### 13.1 Conducted Emissions Measurement

##### LIMIT

According to the requirements of FCC PART 15.207, the limits are as follows:

Frequency (MHz)	Quasi-peak	Average
0.15 to 0.5	66 to 56	56 to 46
0.5 to 5	56	46
5 to 30	60	50

- Note:
1. If the limits for the average detector are met when using the quasi-peak detector, then the limits for the measurements with the average detector are considered to be met.
  2. The lower limit shall apply at the transition frequencies.
  3. The limit decreases linearly with the logarithm of the frequency in the range 0.15 MHz to 0.5MHz.

##### BLOCK DIAGRAM OF TEST SETUP

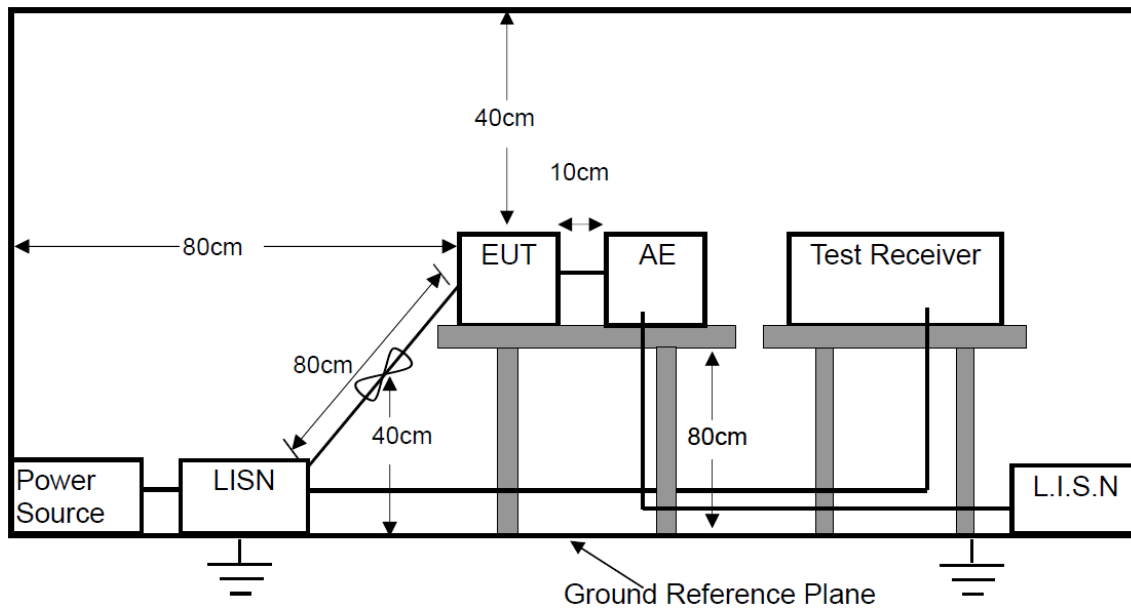

---

## TEST PROCEDURES

- a. The EUT was placed on a wooden table 0.8m height from the metal ground plan and 0.4m from the conducting wall of the shielding room and it was kept at 0.8m from any other grounded conducting surface.
- b. All I/O cables and support devices were positioned as per ANSI C63.10.
- c. Connect mains power port of the EUT to a line impedance stabilization network (LISN).
- d. Connect all support devices to the other LISN and AAN, if needed.
- e. Scan the frequency range from 150KHz to 30MHz at both sides of AC line for maximum conducted interference checking and record the test data.

## TEST RESULTS

PASS

Please refer to the following pages of the worst case.

M/N: HEATCURE 400	Testing Voltage: AC 240V / 50Hz
Phase: L1	Detector: QP & AVG
Test Mode: 6 (the worst case)	

### Conducted Emission Measurement

Date: 2021/9/2

Time: 10:33:18

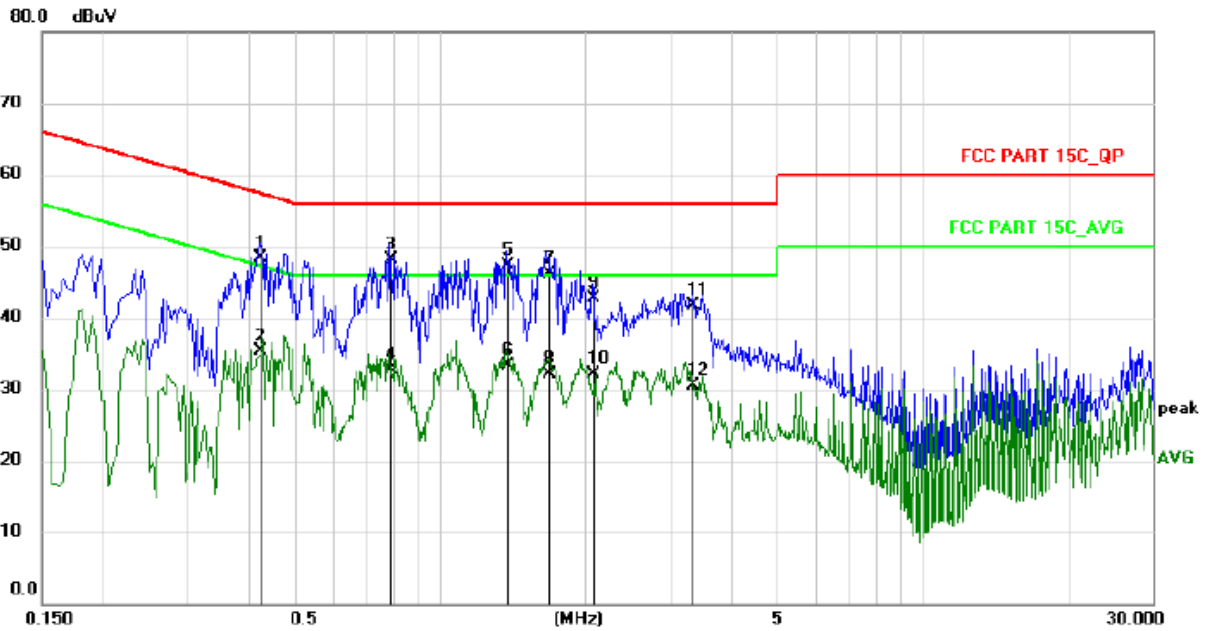

No. Mk.	Freq. MHz	Reading Level dBuV	Correct Factor dB	Measure- ment dBuV	Limit dBuV	Over dB	Detector	Comment
1	0.4220	37.78	10.62	48.40	57.41	-9.01	QP	
2	0.4220	24.68	10.62	35.30	47.41	-12.11	AVG	
3 *	0.7900	37.53	10.67	48.20	56.00	-7.80	QP	
4	0.7900	22.13	10.67	32.80	46.00	-13.20	AVG	
5	1.3779	36.60	10.70	47.30	56.00	-8.70	QP	
6	1.3779	22.70	10.70	33.40	46.00	-12.60	AVG	
7	1.6820	35.50	10.70	46.20	56.00	-9.80	QP	
8	1.6820	21.50	10.70	32.20	46.00	-13.80	AVG	
9	2.0740	32.00	10.70	42.70	56.00	-13.30	QP	
10	2.0740	21.50	10.70	32.20	46.00	-13.80	AVG	
11	3.3380	31.09	10.71	41.80	56.00	-14.20	QP	
12	3.3380	19.79	10.71	30.50	46.00	-15.50	AVG	

M/N: HEATCURE 400	Testing Voltage: AC 240V / 50Hz
Phase: N	Detector: QP & AVG
Test Mode: 6 (the worst case)	

### Conducted Emission Measurement

Date: 2021/9/2

Time: 10:38:48

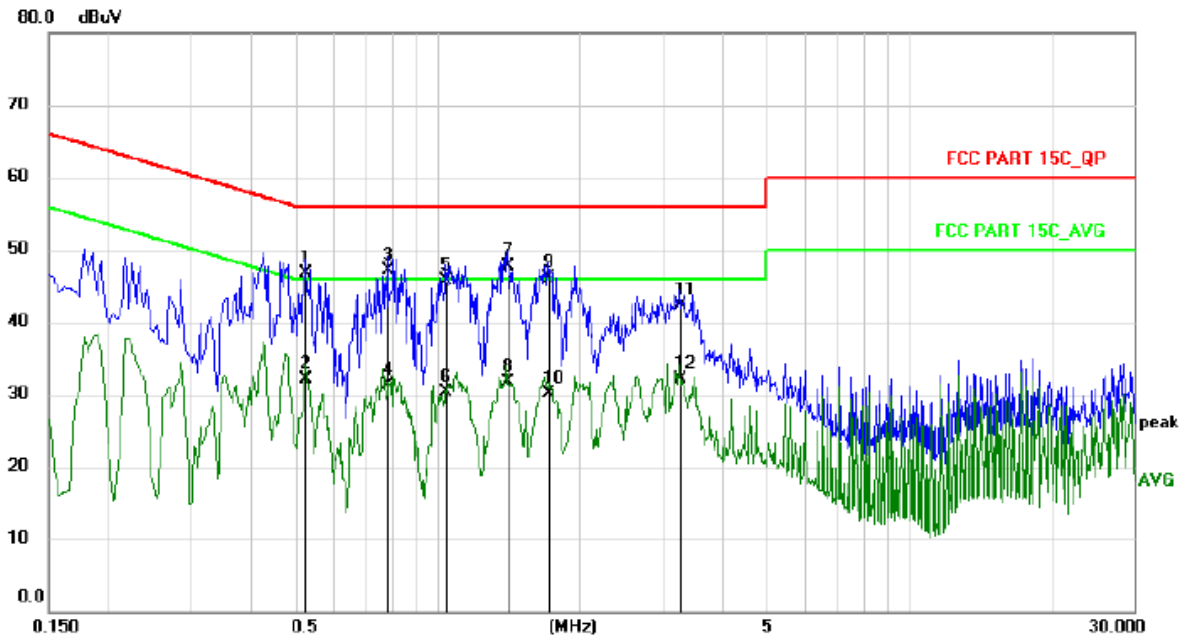

No. Mk.	Freq.	Reading Level	Correct Factor	Measurement	Limit	Over	Detector	Comment
	MHz	dBuV	dB	dBuV	dBuV	dB		
1	0.5260	36.07	10.63	46.70	56.00	-9.30	QP	
2	0.5260	21.47	10.63	32.10	46.00	-13.90	AVG	
3	0.7860	36.43	10.67	47.10	56.00	-8.90	QP	
4	0.7860	20.73	10.67	31.40	46.00	-14.60	AVG	
5	1.0380	35.10	10.70	45.80	56.00	-10.20	QP	
6	1.0380	19.60	10.70	30.30	46.00	-15.70	AVG	
7 *	1.4060	37.10	10.70	47.80	56.00	-8.20	QP	
8	1.4060	21.10	10.70	31.80	46.00	-14.20	AVG	
9	1.7100	35.40	10.70	46.10	56.00	-9.90	QP	
10	1.7100	19.50	10.70	30.20	46.00	-15.80	AVG	
11	3.2620	31.69	10.71	42.40	56.00	-13.60	QP	
12	3.2620	21.39	10.71	32.10	46.00	-13.90	AVG	

## 13.2 Radiated Spurious Emissions and Restricted Bands Measurement

### LIMIT

Frequency range MHz	Distance Meters	Field Strengths Limit (15.209)	
		μV/m	
0.009 ~ 0.490	300	2400/F(kHz)	
0.490 ~ 1.705	30	24000/F(kHz)	
1.705 ~ 30	30	30	
30 ~ 88	3	100	
88 ~ 216	3	150	
216 ~ 960	3	200	
Above 960	3	500	
Frequency range MHz	Distance Meters	Field Strengths Limit (15.249)	
		mV/m (Field strength of fundamental)	μV/m (Field strength of Harmonics)
902 ~ 928	3	50	500
2400 ~ 2483.5	3	50	500
5725 ~ 5875	3	50	500
24000 ~ 2425000	3	250	2500

- Remark: (1) Emission level (dB)μV = 20 log Emission level μV/m
- (2) The smaller limit shall apply at the cross point between two frequency bands.
- (3) As shown in 15.35(b), for frequencies above 1000MHz, the field strength limits are based on average detector, however, the peak field strength of any emission shall not exceed the maximum permitted average limits, specified above by more than 20dB under any condition of modulation.
- (4) The frequency range scanned is from the lowest radio frequency signal generated in the device which is greater than 9 kHz to the tenth harmonic of the highest fundamental frequency or 40 GHz, whichever is lower.
- (5) §15.249(d) specifies that emissions which fall in the restricted bands, as defined in §15.205 comply with radiated emission limits specified in §15.209.



**BLOCK DIAGRAM OF TEST SETUP**

For Radiated Emission below 30MHz

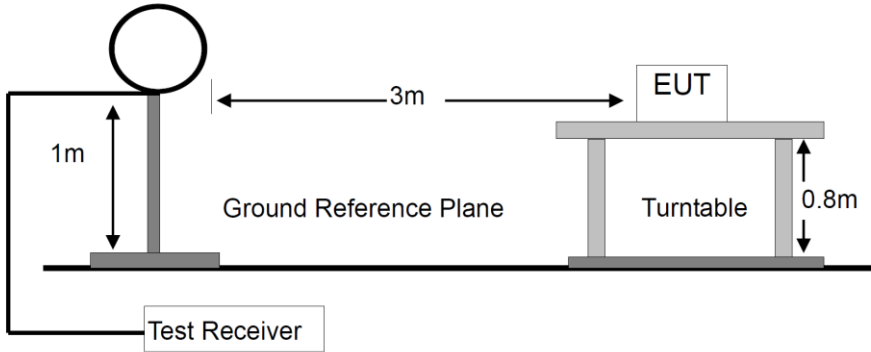

For Radiated Emission 30-1000MHz

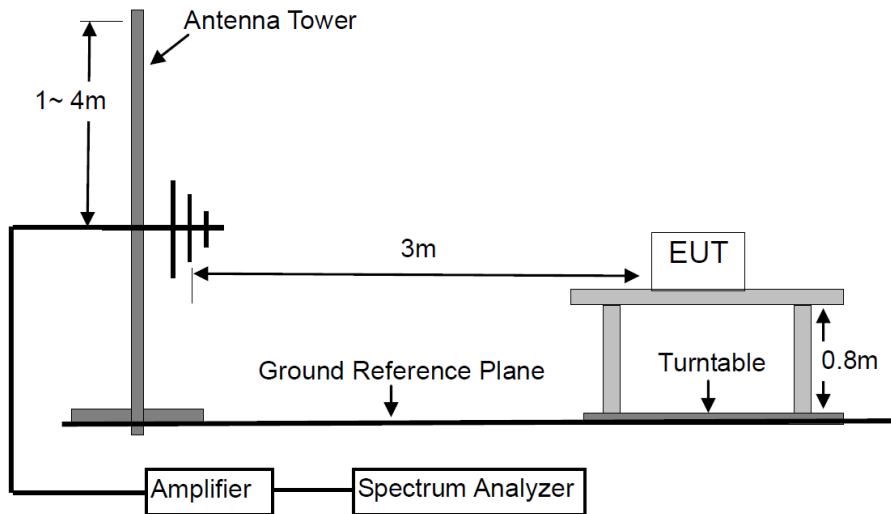

For Radiated Emission Above 1000MHz.

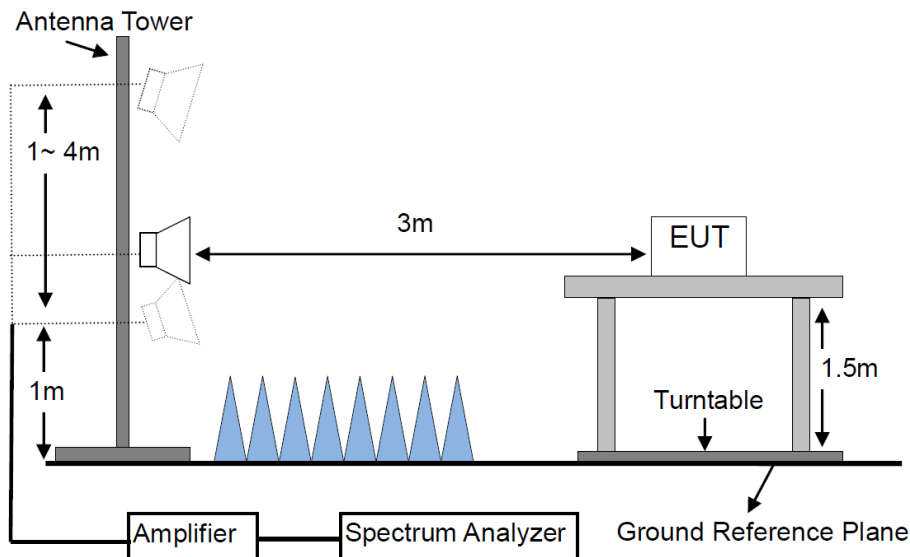

## TEST PROCEDURES

- a. Below 1GHz, the EUT was placed on the top of a rotating table 0.8 meters above the ground at a 3 meter semi- anechoic chamber room.
  - b. For the radiated emission test above 1GHz:  
The EUT was placed on the top of a rotating table 1.5 meters above the ground at a 3 meter full anechoic chamber room. The table was rotated 360 degrees to determine the position of the highest radiation. Place the measurement antenna away from each area of the EUT determined to be a source of emissions at the specified measurement distance, while keeping the measurement antenna aimed at the source of emissions at each frequency of significant emissions, with polarization oriented for maximum response. The measurement antenna may have to be higher or lower than the EUT, depending on the radiation pattern of the emission and staying aimed at the emission source for receiving the maximum signal. The final measurement antenna elevation shall be that which maximizes the emissions. The measurement antenna elevation for maximum emissions shall be restricted to a range of heights of from 1 m to 4 m above the ground or reference ground plane.
  - c. The EUT was set 3 meters away from the interference-receiving antenna, which was mounted on the top of a variable-height antenna tower.
  - d. The height of antenna is varied from one meter to four meters above the ground to determine the maximum value of the field strength. Both horizontal and vertical polarizations of the antenna are set to make the measurement.
  - e. For each suspected emission, the EUT was arranged to its worst case and then the antenna was tuned to heights from 1 meter to 4 meters and the rotatable table was turned from 0 degrees to 360 degrees to find the maximum reading. The test-receiver system was set to peak detect function and specified bandwidth with maximum hold mode.
  - f. A Quasi-peak measurement was then made for that frequency point for below 1GHz test. PK and AV for above 1GHz emission test.
  - g. Pre-Scan has been conducted to determine the worst-case mode from all possible combinations between available modulations, data rates, XYZ axis and packet type.  
The worst case was found when the EUT was positioned on X axis for radiated emission.
- During the radiated emission test, the spectrum analyzer was set with the following configurations:

Frequency Band	Detector	Resolution Bandwidth	Video Bandwidth
9KHz to 90KHz	AVG	300Hz	900Hz
91KHz to 109KHz	QP	300Hz	900Hz
110KHz to 490KHz	AVG	300Hz	900Hz
150KHz to 30MHz	QP	10KHz	300KHz
30MHz to 1000MHz	QP	120 KHz	300 KHz
Above 1000MHz	Peak	1 MHz	3 MHz
	Average	1 MHz	10 Hz

## **TEST RESULTS**

PASS

Please refer to the following pages of the worst case.

M/N: HEATCURE 400	Testing Voltage: AC 120V 60Hz
Polarization: Horizontal	Detector: Peak
Test Mode: 6 (the worst case)	Distance: 3m

## Radiated Emission Measurement

Date: 2021/8/19

Time: 2:29:32

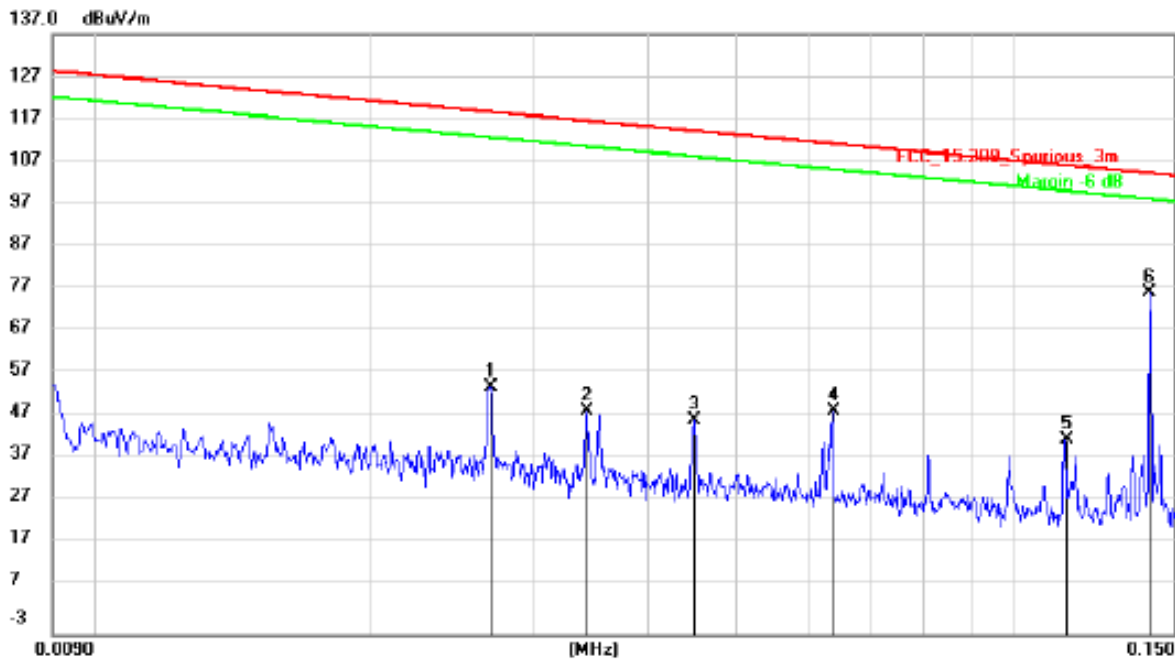

No.	Mk.	Freq.	Reading Level	Correct Factor	Measurement	Limit	Over	Detector	Comment
		MHz	dBuV	dB/m	dBuV/m	dBuV/m	dB		
1		0.0270	34.25	20.49	54.74	118.84	-64.10	AVG	
2		0.0343	28.59	20.52	49.11	116.77	-67.66	AVG	
3		0.0450	26.17	20.59	46.76	114.42	-67.66	AVG	
4		0.0636	28.61	20.53	49.14	111.44	-62.30	AVG	
5		0.1142	21.94	20.53	42.47	106.38	-63.91	AVG	
6	*	0.1409	56.00	20.53	76.53	104.57	-28.04	AVG	

M/N: HEATCURE 400	Testing Voltage: AC 120V 60Hz
Polarization: Horizontal	Detector: Peak
Test Mode: 6 (the worst case)	Distance: 3m

## Radiated Emission Measurement

Date: 2021/8/19

Time: 2:22:01

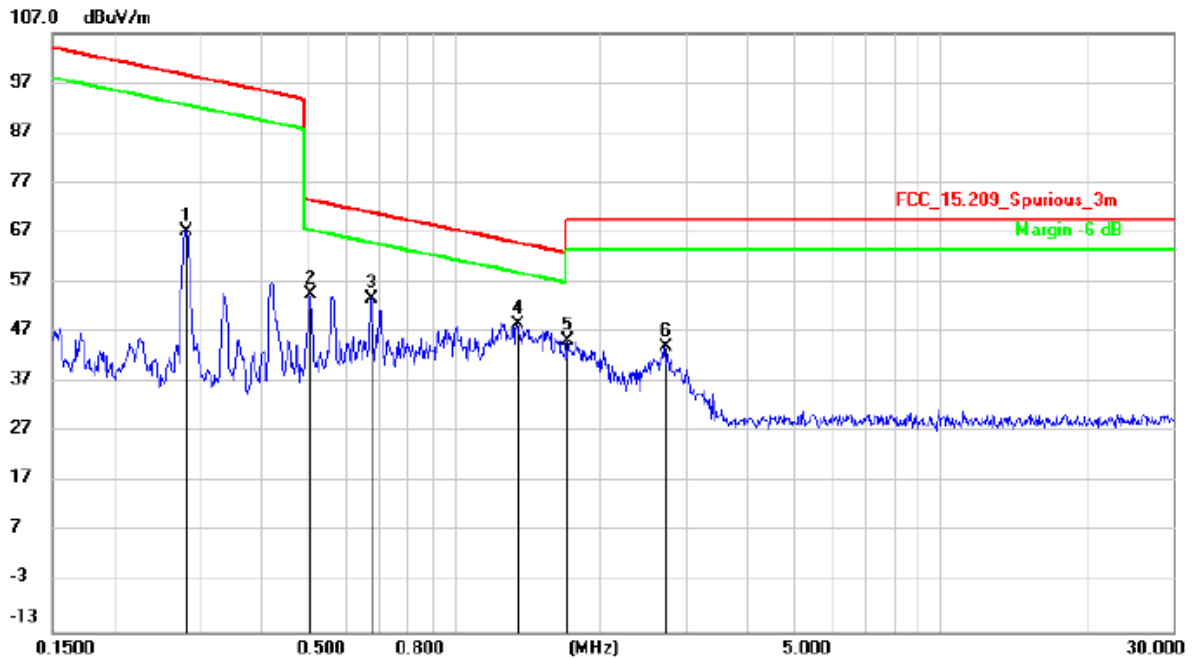

No.	Mk.	Freq.	Reading Level	Correct Factor	Measurement	Limit	Over	Detector	Comment
		MHz	dBuV	dB/m	dBuV/m	dBuV/m	dB		
1		0.2803	46.74	20.49	67.23	98.62	-31.39	AVG	
2		0.5047	34.20	20.45	54.65	73.54	-18.89	QP	
3		0.6719	33.34	20.43	53.77	71.06	-17.29	QP	
4	*	1.3450	28.32	20.40	48.72	65.03	-16.31	QP	
5		1.6981	24.87	20.40	45.27	63.01	-17.74	QP	
6		2.7068	23.71	20.40	44.11	69.50	-25.39	QP	

M/N: HEATCURE 400	Testing Voltage: AC 120V 60Hz
Polarization: Vertical	Detector: Peak
Test Mode: 6 (the worst case)	Distance: 3m

## Radiated Emission Measurement

Date: 2021/8/19

Time: 2:08:38

137.0 dBuV/m

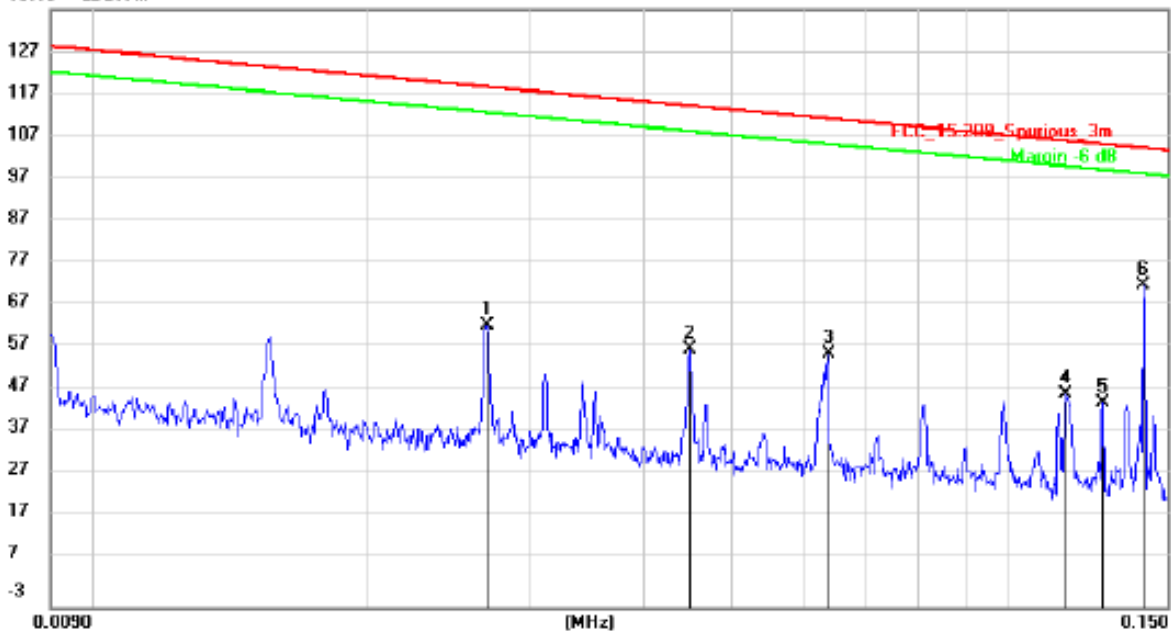

No.	Mk.	Freq.	Reading Level	Correct Factor	Measurement	Limit	Over	Detector	Comment
		MHz	dBuV	dB/m	dBuV/m	dBuV/m	dB		
1		0.0270	42.44	20.49	62.93	118.84	-55.91	AVG	
2		0.0450	36.79	20.59	57.38	114.42	-57.04	AVG	
3		0.0636	35.64	20.53	56.17	111.44	-55.27	AVG	
4		0.1161	26.20	20.53	46.73	106.24	-59.51	AVG	
5		0.1274	24.27	20.53	44.80	105.44	-60.64	AVG	
6	*	0.1409	51.97	20.53	72.50	104.57	-32.07	AVG	

M/N: HEATCURE 400	Testing Voltage: AC 120V 60Hz
Polarization: Vertical	Detector: Peak
Test Mode: 6 (the worst case)	Distance: 3m

## Radiated Emission Measurement

Date: 2021/8/19

Time: 2:15:10

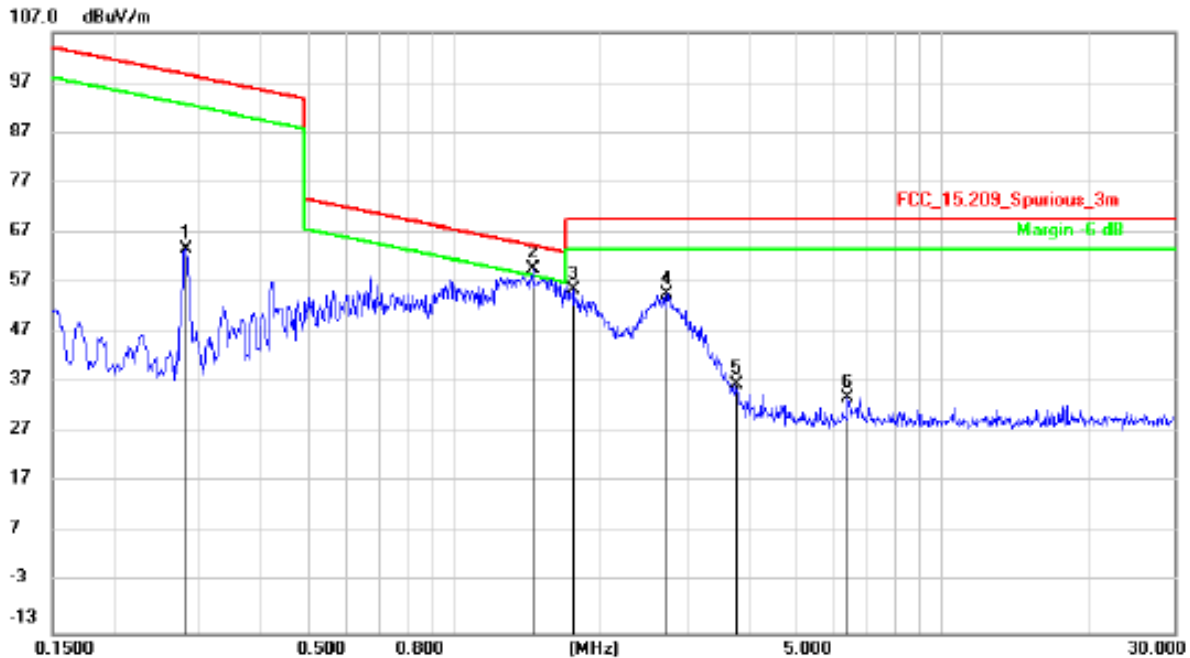

No.	Mk.	Freq.	Reading Level	Correct Factor	Measurement	Limit	Over	Detector	Comment
		MHz	dBuV	dB/m	dBuV/m	dBuV/m	dB		
1		0.2803	43.22	20.49	63.71	98.62	-34.91	AVG	
2	*	1.4485	39.40	20.40	59.80	64.39	-4.59	QP	
3		1.7529	35.14	20.40	55.54	69.50	-13.96	QP	
4		2.7068	34.17	20.40	54.57	69.50	-14.93	QP	
5		3.7794	16.27	20.42	36.69	69.50	-32.81	QP	
6		6.4198	13.44	20.47	33.91	69.50	-35.59	QP	

M/N: HEATCURE 400	Testing Voltage: AC 120V 60Hz
Polarization: Horizontal	Detector: QP
Test Mode: 6 (the worst case)	Distance: 3m

## Radiated Emission Measurement

Date: 2021/8/31

Time: 17:14:40

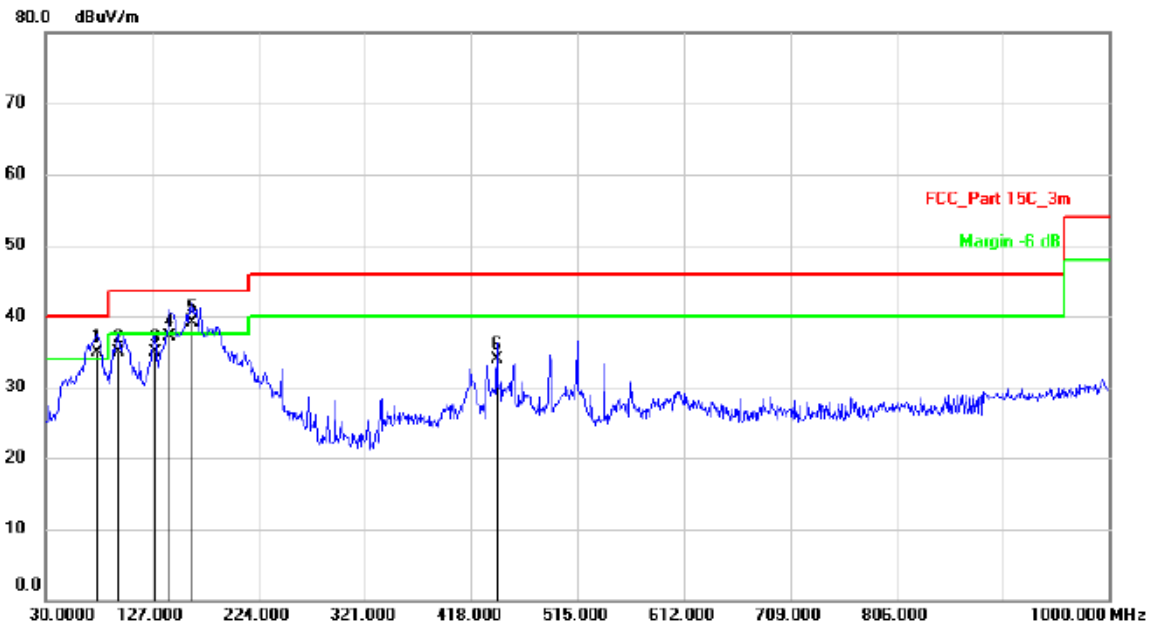

No.	Mk.	Freq.	Reading Level	Correct Factor	Measurement	Limit	Over	Detector	Comment
		MHz	dBuV	dB/m	dBuV/m	dBuV/m	dB		
1	!	76.5600	47.20	-12.20	35.00	40.00	-5.00	QP	
2		95.9600	42.89	-8.07	34.82	43.50	-8.68	QP	
3		129.9100	45.52	-10.52	35.00	43.50	-8.50	QP	
4		142.5200	48.16	-10.96	37.20	43.50	-6.30	QP	
5	*	163.8600	49.47	-10.27	39.20	43.50	-4.30	QP	
6		441.2800	36.65	-2.70	33.95	46.00	-12.05	QP	



M/N: HEATCURE 400	Testing Voltage: AC 120V 60Hz
Polarization: Vertical	Detector: QP
Test Mode: 6 (the worst case)	Distance: 3m

## Radiated Emission Measurement

Date: 2021/8/31

Time: 17:20:18

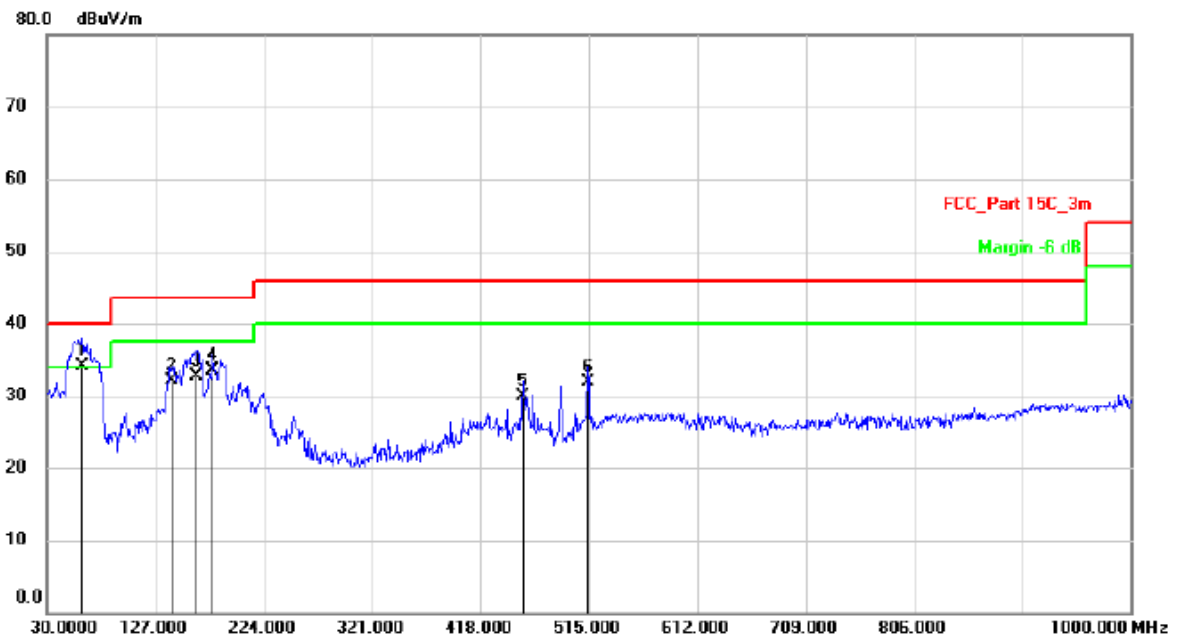

No.	Mk.	Freq.	Reading Level	Correct Factor	Measurement	Limit	Over	Detector	Comment
		MHz	dBuV	dB/m	dBuV/m	dBuV/m	dB		
1	*	61.0400	42.06	-7.96	34.10	40.00	-5.90	QP	
2		141.5500	43.64	-11.54	32.10	43.50	-11.40	QP	
3		163.8600	43.44	-10.64	32.80	43.50	-10.70	QP	
4		178.4100	43.03	-9.53	33.50	43.50	-10.00	QP	
5		455.8300	33.36	-3.46	29.90	46.00	-16.10	QP	
6		514.0300	34.53	-2.53	32.00	46.00	-14.00	QP	

---

### 13.3 20dB Bandwidth Measurement

#### LIMIT

There is no limit.

#### BLOCK DIAGRAM OF TEST SETUP

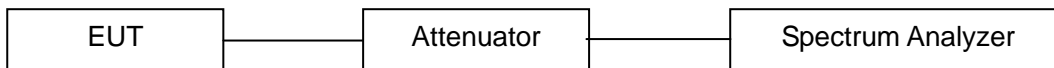

#### TEST PROCEDURES

The 20dB bandwidth of the emission was contained within the frequency band designated which the EUT operated. The effects, if any, from frequency sweeping, frequency hopping, other modulation techniques and frequency stability over excepted variations in temperature and supply voltage were considered, FCC Rule 15.35:

The antenna port of the EUT was connected to the input of a spectrum analyzer. Analyzer RBW was chosen so that the display was a result of the tested channel modulation. For each RF output channel investigated, the spectrum analyzer center frequency was set to the channel carrier. Use the spectrum 20dB down delta function to measure the bandwidth.

#### TEST RESULTS

PASS

Please refer to the following table.

FSK		
Frequency (KHz)	20dB Bandwidth (Hz)	Result
140.9	820	PASS

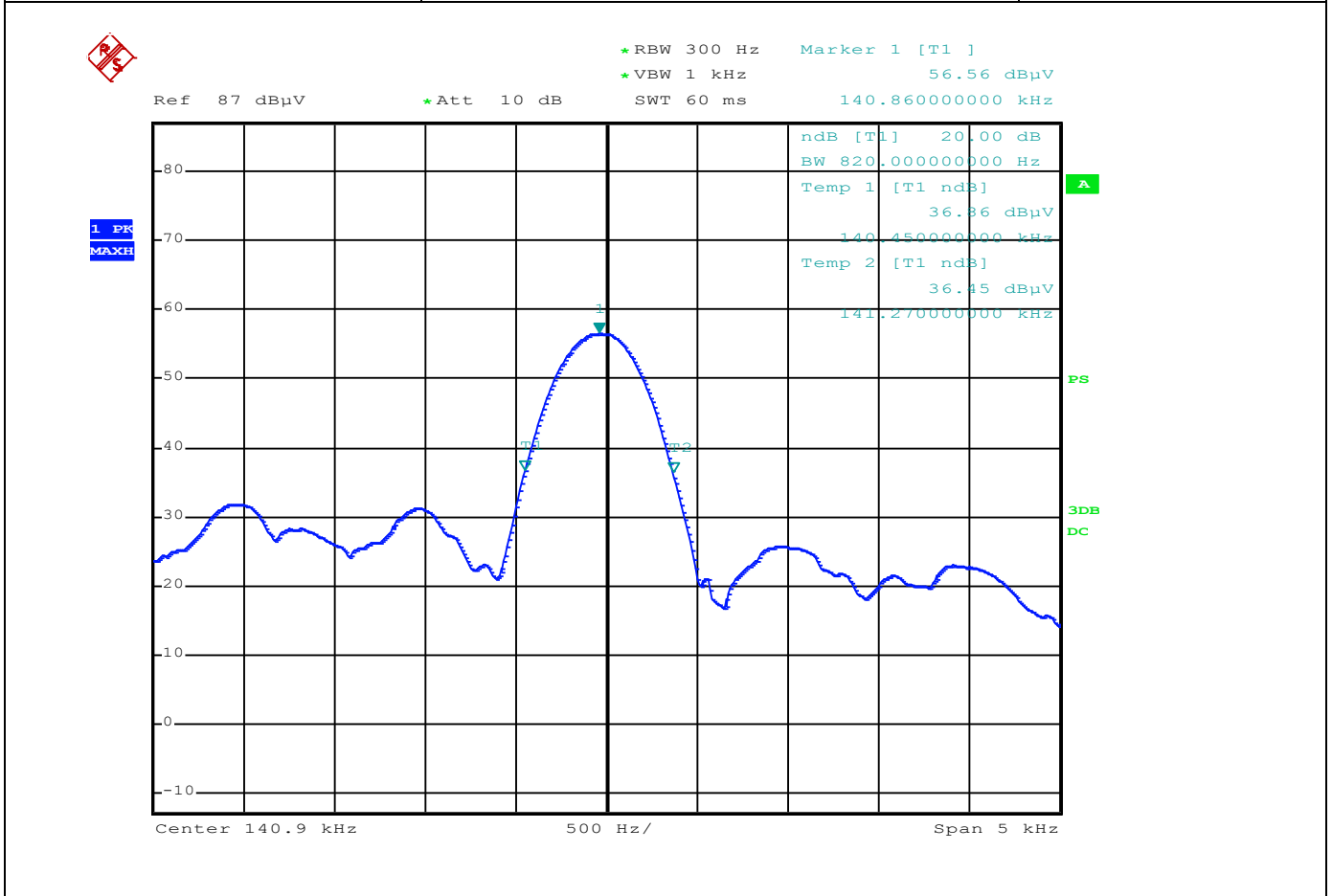

---

## **13.4 Antenna Requirement**

### **STANDARD APPLICABLE**

According to of FCC part 15C section 15.203:

An intentional radiator shall be designed to ensure that no antenna other than that furnished by the responsible party shall be used with the device. The use of a permanently attached antenna or of an antenna that uses a unique coupling to the intentional radiator, the manufacturer may design the unit so that a broken antenna can be replaced by the user, but the use of a standard antenna jack or electrical connector is prohibited.

Systems operating in the 2400-2483.5MHz band that are used exclusively for fixed, point-to-point operations may employ transmitting antennas with directional gain greater than 6dBi provided the maximum peak output power of the intentional radiator is reduced by 1dB for every 3dB that the directional gain of the antenna exceeds 6dBi.

### **ANTENNA CONNECTED CONSTRUCTION**

The antenna is Coil antenna that no antenna other than furnished by the responsible party shall be used with the device. Therefore, the antenna is consider meet the requirement.

## 14. Test Equipment List

Item	Equipment	Manufacturer	Model No.	Serial No.	Last Cal.	Cal. Interval
1.	Test Receiver	Rohde & Schwarz	ESCI7	100837	Mar. 13, 2021	1 Year
2.	Antenna	Schwarzbeck	VULB9162	9162-010	Mar. 23, 2021	1 Year
3.	Spectrum Analyzer	Rohde & Schwarz	FSU26	200409/026	Mar. 13, 2021	1 Year
4.	Spectrum Analyzer	Keysight	N9020A	MY54200831	Mar. 13, 2021	1 Year
5.	Spectrum Analyzer	Rohde & Schwarz	FSV40	101094	Mar. 13, 2021	1 Year
6.	Horn Antenna	Schwarzbeck	BBHA9170	9170-172	Mar. 22, 2021	2 Year
7.	Power Sensor	DARE	RPR3006W	15I00041SNO 64	Mar. 13, 2021	1 Year
8.	Communication Tester	Rohde & Schwarz	CMW500	149004	Mar. 13, 2021	1 Year
9.	Horn Antenna	COM-Power	AH-118	071078	Mar. 23, 2021	1 Year
10.	Pre-Amplifier	HP	HP 8449B	3008A00964	Mar. 13, 2021	1 Year
11.	Pre-Amplifier	HP	HP 8447D	1145A00203	Mar. 13, 2021	1 Year
12.	Loop Antenna	Schwarzbeck	FMZB 1513	1513-272	Mar. 23, 2021	1 Year
13.	Test Receiver	Rohde & Schwarz	ESCI	101152	Mar. 14, 2021	1 Year
14.	L.I.S.N	Rohde & Schwarz	ENV 216	101317	Mar. 13, 2021	1 Year
15.	L.I.S.N	Rohde & Schwarz	ESH2-Z5	893606/014	Mar. 13, 2021	1 Year
16.	RF Switching Unit	Compliance Direction Systems Inc.	RSU-M2	38311	Mar.13, 2021	1 Year
17.	Temperature & Humidity Chamber	REMAFEE	SYHR225L	N/A	Mar. 13, 2021	1 Year
18.	DC Source	Maynuo	MY8811	N/A	Mar. 13, 2021	1 Year
19.	Temporary antenna connector	TESCOM	SS402	N/A	N/A	N/A
20.	Chamber	SAEMC	9*7*7m	N/A	Apr. 21, 2021	2 Year
21.	Test Software	EZ	EZ_EMG	N/A	N/A	N/A

Note: For photographs of EUT and measurement, please refer to appendix in separate documents.

---End---