

TECHNICAL REPORT



Report No.: TW2109144E  
File Reference No.: 2021-10-13

Applicant: Ningbo Free Trade Zone Rising Sun Electrical Co.,Ltd.

Product: Wireless Remote Control Outlet

Model No.: RSN011R, RSN021R

Trademark: Risingsun

Test Standards: FCC Part 15.247

Test Result: It is herewith confirmed and found to comply with the requirements set up by ANSI C63.10, FCC Part 15.247 for the evaluation of electromagnetic compatibility

Approved By

A handwritten signature in black ink, appearing to read 'Jack Chung'.

Jack Chung

Manager

Dated: October 13, 2021

**Results appearing herein relate only to the sample tested**

**The technical reports is issued errors and omissions exempt and is subject to withdrawal at**

**SHENZHEN TIMEWAY TESTING LABORATORIES**

Zone C, 1st Floor, Block B, Jun Xiang Da Building, Zhongshan Park Road West, Tong Le Village, Nanshan District, Shenzhen, China

Tel (755) 83448688, Fax (755) 83442996, E-Mail:info@timeway-lab.com



### **Special Statement:**

The testing quality ability of our laboratory meet with “Quality Law of People’s Republic of China” Clause 19.

The testing quality system of our laboratory meet with ISO/IEC-17025 requirements, which is approved by CNAL. This approval result is accepted by MRA of APLAC.

Our test facility is recognized, certified, or accredited by the following organizations:

#### **CNAS-LAB Code: L2292**

The EMC Laboratory has been assessed and in compliance with CNAS-CL01 accreditation criteria for testing Laboratories (identical to ISO/IEC 17025:2005 General Requirements) for the Competence of testing Laboratories.

#### **FCC-Registration No.: 744189**

The EMC Laboratory has been registered and fully described in a report filed with the (FCC) Federal Communications commission. The acceptance letter from the FCC is maintained in our files. Registration No.: 744189.

#### **Industry Canada (IC) —Registration No.:5205A**

The EMC Laboratory has been registered by Certification and Engineering Bureau of Industry Canada for radio equipment testing with Registration No.: 5205A.

#### **A2LA (Certification Number:5013.01)**

The EMC Laboratory has been accredited by the American Association for Laboratory Accreditation (A2LA). Certification Number:5013.01

The report refers only to the sample tested and does not apply to the bulk.

This report is issued in confidence to the client and it will be strictly treated as such by the SHENZHEN TIMEWAY TESTING LABORATORIES. It may not be reproduced rather in its entirety or in part and it may not be used for adverting. The client to whom the report is issued may, however, show or send it . or a certified copy there of prepared by the SHENZHEN TIMEWAY TESTING LABORATORIES. to his customer. Supplier or others persons directly concerned. SHENZHEN TIMEWAY TESTING LABORATORIES. will not, without the consent of the client enter into any discussion of correspondence with any third party concerning the contents of the report.

In the event of the improper use of the report. The SHENZHEN TIMEWAY TESTING LABORATORIES. reserves the rights to withdraw it and to adopt any other remedies which may be appropriate.



Test Report Conclusion  
Content

<b>1.0</b>	<b>General Details</b> .....	4
1.1	Test Lab Details.....	4
1.2	Applicant Details.....	4
1.3	Description of EUT .....	4
1.4	Submitted Sample.....	5
1.5	Test Duration.....	5
1.6	Test Uncertainty.....	5
1.7	Test By.....	5
<b>2.0</b>	<b>List of Measurement Equipment</b> .....	6
<b>3.0</b>	<b>Technical Details</b> .....	8
3.1	Summary of Test Results.....	8
3.2	Test Standards.....	8
<b>4.0</b>	<b>EUT Modification</b> .....	8
<b>5.0</b>	<b>Power Line Conducted Emission Test</b> .....	9
5.1	Schematics of the Test.....	9
5.2	Test Method and Test Procedure.....	9
5.3	Configuration of the EUT.....	9
<b>5.4</b>	<b>EUT Operating Condition</b> .....	10
<b>5.5</b>	<b>Conducted Emission Limit</b> .....	10
<b>5.6</b>	<b>Test Result</b> .....	10
<b>6.0</b>	<b>Radiated Emission test</b> .....	13
6.1	Test Method and Test Procedure.....	13
6.2	Configuration of the EUT.....	14
6.3	EUT Operation Condition.....	14
6.4	Radiated Emission Limit.....	14
7.0	6dB Bandwidth Measurement.....	24
8.0	Maximum Output Power.....	44
9.0	Power Spectral Density Measurement.....	47
10.0	Out of Band Measurement.....	65
11.0	Antenna Requirement.....	80
12.0	FCC ID Label.....	81
13.0	Photo of Test Setup and EUT View.....	82

The report refers only to the sample tested and does not apply to the bulk.

This report is issued in confidence to the client and it will be strictly treated as such by the SHENZHEN TIMEWAY TESTING LABORATORIES. It may not be reproduced rather in its entirety or in part and it may not be used for advertising. The client to whom the report is issued may, however, show or send it, or a certified copy thereof prepared by the SHENZHEN TIMEWAY TESTING LABORATORIES, to his customer. Supplier or others persons directly concerned. SHENZHEN TIMEWAY TESTING LABORATORIES, will not, without the consent of the client enter into any discussion of correspondence with any third party concerning the contents of the report.

In the event of the improper use of the report. The SHENZHEN TIMEWAY TESTING LABORATORIES, reserves the rights to withdraw it and to adopt any other remedies which may be appropriate.



## 1.0 General Details

### 1.1 Test Lab Details

Name : SHENZHEN TIMEWAY TESTING LABORATORIES.  
Address: Zone C, 1st Floor, Block B, Jun Xiang Da Building, Zhongshan Park Road West, Tong Le Village, Nanshan District, Shenzhen, China  
Telephone: (755) 83448688  
Fax: (755) 83442996  
Site Listed with Federal Communications commission (FCC)  
Registration Number:744189  
For 3m Anechoic Chamber  
Site Listed with Industry Canada of Ottawa, Canada  
Registration Number: IC: 5205A  
For 3m Anechoic Chamber

### 1.2 Applicant Details

Applicant: Ningbo Free Trade Zone Rising Sun Electrical Co.,Ltd.  
Address: No.17, Chuanye 1 Road, West Part of Free Trade Zone, Ningbo, China  
Telephone: 0574-27688066  
Fax: 0574-27688063

### 1.3 Description of EUT

Product: Wireless Remote Control Outlet  
Manufacturer: Ningbo Free Trade Zone Rising Sun Electrical Co.,Ltd.  
Address: No.17, Chuanye 1 Road, West Part of Free Trade Zone, Ningbo, China  
Trademark: Risingsun  
Model Number: RSN011R  
Additional Model Number: RSN021R  
Hardware Version: 1.0  
Software Version: 1.0  
Serial No.: N1121  
Type of Modulation IEEE 802.11b: DSSS (CCK, QPSK, DBPSK)  
IEEE 802.11g/n (HT20, HT40): OFDM (64QAM, 16QAM, QPSK, BPSK)  
Frequency range IEEE 802.11b/g/n (HT20): 2412-2462MHz; 802.11n HT40: 2422-2452MHz  
Channel Spacing 5MHz for IEEE 802.11b/g/n HT20, HT40  
Air Data Rate IEEE 802.11b: 11, 5.5, 2, 1 Mbps  
IEEE 802.11g: 54, 48,36, 24, 18, 12, 9, 6 Mbps  
IEEE 802.11n HT20/HT40: mcs0-mcs9  
Frequency Selection By software  
Channel Number IEEE 802.11b/g/n (HT20): 11 Channels; IEEE 802.11n (HT40): 7 Channels;

The report refers only to the sample tested and does not apply to the bulk.

This report is issued in confidence to the client and it will be strictly treated as such by the SHENZHEN TIMEWAY TESTING LABORATORIES. It may not be reproduced rather in its entirety or in part and it may not be used for advertising. The client to whom the report is issued may, however, show or send it . or a certified copy thereof prepared by the SHENZHEN TIMEWAY TESTING LABORATORIES. to his customer. Supplier or others persons directly concerned. SHENZHEN TIMEWAY TESTING LABORATORIES. will not, without the consent of the client enter into any discussion of correspondence with any third party concerning the contents of the report.

In the event of the improper use of the report. The SHENZHEN TIMEWAY TESTING LABORATORIES. reserves the rights to withdraw it and to adopt any other remedies which may be appropriate.



Antenna: PCB Antenna used. The gain of the antenna is 1.0dBi for each one (Declared by the applicant)

Rating: Input: 120V~, 60Hz, 15A, 1800W; Output: 120V, 60Hz, 15A, 1800W

1.4 Submitted Sample: 1 Samples

1.5 Test Duration: 2021-09-14 to 2021-10-13

1.6 Test Uncertainty

Conducted Emissions Uncertainty =3.6dB

Radiated Emissions below 1GHz Uncertainty =4.7dB

Radiated Emissions above 1GHz Uncertainty =6.0dB

Conducted Power Uncertainty =6.0dB

Occupied Channel Bandwidth Uncertainty =5%

Note: The measurement uncertainty is for coverage factor of k=2 and a level of confidence of 95%.

1.7 Test Engineer

The sample tested by Terry Tang

Print Name: Terry Tang

The report refers only to the sample tested and does not apply to the bulk.

This report is issued in confidence to the client and it will be strictly treated as such by the SHENZHEN TIMEWAY TESTING LABORATORIES. It may not be reproduced rather in its entirety or in part and it may not be used for advertising. The client to whom the report is issued may, however, show or send it or a certified copy thereof prepared by the SHENZHEN TIMEWAY TESTING LABORATORIES to his customer. Supplier or others persons directly concerned. SHENZHEN TIMEWAY TESTING LABORATORIES will not, without the consent of the client enter into any discussion of correspondence with any third party concerning the contents of the report.

In the event of the improper use of the report. The SHENZHEN TIMEWAY TESTING LABORATORIES reserves the rights to withdraw it and to adopt any other remedies which may be appropriate.



<b>2.0 Test Equipment</b>					
Instrument Type	Manufacturer	Model	Serial No.	Date of Cal.	Due Date
ESPI Test Receiver	R&S	ESPI 3	100379	2021-06-18	2022-06-17
LISN	R&S	EZH3-Z5	100294	2021-06-18	2022-06-17
LISN	R&S	EZH3-Z5	100253	2021-06-18	2022-06-17
Ultra Broadband ANT	R&S	HL562	100157	2021-06-18	2022-06-17
Impuls-Begrenzer	R&S	ESH3-Z2	100281	2021-06-18	2022-06-17
Loop Antenna	EMCO	6507	00078608	2021-06-18	2024-06-17
Spectrum	R&S	FSIQ26	100292	2021-06-18	2022-06-17
Horn Antenna	A-INFO	LB-180400-KF	J211060660	2021-06-18	2023-06-17
Horn Antenna	R&S	BBHA 9120D	9120D-631	2021-07-02	2022-07-01
Power meter	Anritsu	ML2487A	6K00003613	2021-08-22	2022-08-21
Power sensor	Anritsu	MA2491A	32263	2021-08-22	2022-08-21
Bilog Antenna	Schwarebeck	VULB9163	9163/340	2021-07-02	2024-07-01
9*6*6 Anechoic	--	--	N/A	2021-07-02	2024-07-01
EMI Test Receiver	RS	ESVB	826156/011	2021-06-18	2022-06-17
EMI Test Receiver	RS	ESH3	860904/006	2021-06-18	2022-06-17
Spectrum	HP/Agilent	ESA-L1500A	US37451154	2021-06-18	2022-06-17
Spectrum	HP/Agilent	E4407B	MY50441392	2021-06-18	2022-06-17
Spectrum	RS	FSP	1164.4391.38	2021-01-07	2022-01-06
RF Cable	Zhengdi	ZT26-NJ-NJ-8 M/FA	--	2021-06-18	2022-06-17
RF Cable	Zhengdi	7m	--	2021-06-18	2022-06-17
RF Switch	EM	EMSW18	060391	2021-06-18	2022-06-17
Pre-Amplifier	Schwarebeck	BBV9743	#218	2021-06-18	2022-06-17
Pre-Amplifier	HP/Agilent	8449B	3008A00160	2021-06-18	2022-06-17
LISN	SCHAFFNER	NNB42	00012	2021-01-06	2022-01-05

## 2.2 Automation Test Software

### For Conducted Emission Test

Name	Version
EZ-EMC	Ver.EMC-CON 3A1.1

### For Radiated Emissions

Name	Version
EMI Test Software BL410-EV18.91	V18.905
EMI Test Software BL410-EV18.806 High Frequency	V18.06

The report refers only to the sample tested and does not apply to the bulk.

This report is issued in confidence to the client and it will be strictly treated as such by the SHENZHEN TIMEWAY TESTING LABORATORIES. It may not be reproduced rather in its entirety or in part and it may not be used for advertising. The client to whom the report is issued may, however, show or send it, or a certified copy thereof prepared by the SHENZHEN TIMEWAY TESTING LABORATORIES, to his customer. Supplier or others persons directly concerned. SHENZHEN TIMEWAY TESTING LABORATORIES, will not, without the consent of the client enter into any discussion of correspondence with any third party concerning the contents of the report.

In the event of the improper use of the report. The SHENZHEN TIMEWAY TESTING LABORATORIES, reserves the rights to withdraw it and to adopt any other remedies which may be appropriate.



### 3. DESCRIPTION OF TEST MODES

#### IEEE 802.11b, 802.11g, 802.11n (HT20) mode

The EUT had been tested under operating condition. There are three channels have been tested as following:

Channel	Frequency (MHz)
Low	2412
Middle	2437
High	2462

IEEE 802.11b mode: 1Mbps data rate (worst case) was chosen for full testing. IEEE 802.11g mode: 6Mbps data rate (worst case) was chosen for full testing. IEEE 802.11n (HT20) mode: mcs0 (worst case) were chosen for full testing

#### IEEE 802.11n (HT40) mode

The EUT had been tested under operating condition. There are three channels have been tested as following:

Channel	Frequency (MHz)
Low	2422
Middle	2437
High	2452

IEEE 802.11n (HT40) mode: mcs0 data rate (worst case) were chosen for full testing

Note: during the test, the duty cycle was set up to 100%.

The report refers only to the sample tested and does not apply to the bulk.  
This report is issued in confidence to the client and it will be strictly treated as such by the SHENZHEN TIMEWAY TESTING LABORATORIES. It may not be reproduced rather in its entirety or in part and it may not be used for adverting. The client to whom the report is issued may, however, show or send it . or a certified copy there of prepared by the SHENZHEN TIMEWAY TESTING LABORATORIES. to his customer. Supplier or others persons directly concerned. SHENZHEN TIMEWAY TESTING LABORATORIES. will not, without the consent of the client enter into any discussion of correspondence with any third party concerning the contents of the report.  
In the event of the improper use of the report. The SHENZHEN TIMEWAY TESTING LABORATORIES. reserves the rights to withdraw it and to adopt any other remedies which may be appropriate.



**3.0 Technical Details**

**3.1 Summary of test results**

<b>The EUT has been tested according to the following specifications:</b>			
<b>Standard</b>	<b>Test Type</b>	<b>Result</b>	<b>Notes</b>
<b>FCC Part 15, Paragraph 15.107 &amp; 15.207</b>	<b>Conducted Emission Test</b>	<b>Pass</b>	<b>Complies</b>
<b>FCC Part 15 Subpart C Paragraph 15.247(a)(2) Limit</b>	<b>Spectrum bandwidth of a Orthogonal Frequency Division Multiplex System Limit: 6dB bandwidth&gt;500kHz</b>	<b>Pass</b>	<b>Complies</b>
<b>FCC Part 15, Paragraph 15.247(b)</b>	<b>Maximum peak output power Limit: max. 30dBm</b>	<b>Pass</b>	<b>Complies</b>
<b>FCC Part 15, Paragraph 15.109,15.205 &amp; 15.209</b>	<b>Transmitter Radiated Emission Limit: Table 15.209</b>	<b>Pass</b>	<b>Complies</b>
<b>FCC Part 15, Paragraph 15.247(e)</b>	<b>Power Spectral Density Limit: max. 8dBm</b>	<b>Pass</b>	<b>Complies</b>
<b>FCC Part 15, Paragraph 15.247(d)</b>	<b>Out of Band Emission and Restricted Band Radiation Limit: 20dB less than peak value of fundamental frequency Restricted band limit: Table 15.209</b>	<b>Pass</b>	<b>Complies</b>

**3.2 Test Standards**

**FCC Part 15 Subpart & Subpart C, Paragraph 15.247**

**4.0 EUT Modification**

**No modification by SHENZHEN TIMEWAY TESTING LABORATORIES.**

The report refers only to the sample tested and does not apply to the bulk.  
 This report is issued in confidence to the client and it will be strictly treated as such by the SHENZHEN TIMEWAY TESTING LABORATORIES. It may not be reproduced rather in its entirety or in part and it may not be used for advertising. The client to whom the report is issued may, however, show or send it . or a certified copy there of prepared by the SHENZHEN TIMEWAY TESTING LABORATORIES. to his customer. Supplier or others persons directly concerned. SHENZHEN TIMEWAY TESTING LABORATORIES. will not, without the consent of the client enter into any discussion of correspondence with any third party concerning the contents of the report.  
 In the event of the improper use of the report. The SHENZHEN TIMEWAY TESTING LABORATORIES. reserves the rights to withdraw it and to adopt any other remedies which may be appropriate.





**5.0 Power Line Conducted Emission Test**

5.1 Schematics of the test

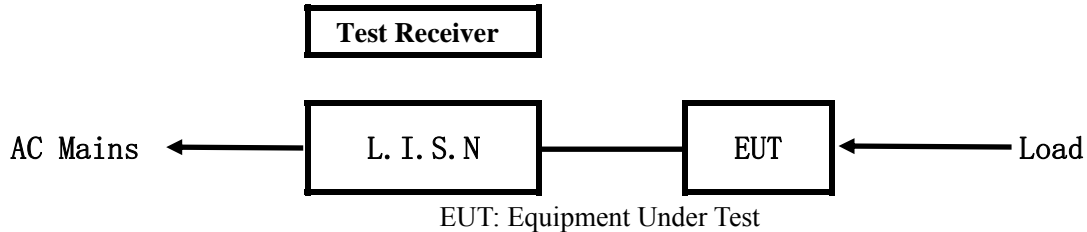

5.2 Test Method and test Procedure

The EUT was tested according to ANSI C63.10-2013. The Frequency spectrum From 0.15MHz to 30MHz was investigated. The LISN used was 50ohm/50uH as specified by section 5.1 of ANSI C63.10 –2013.

Test Voltage: 120V~, 60Hz

Block diagram of Test setup

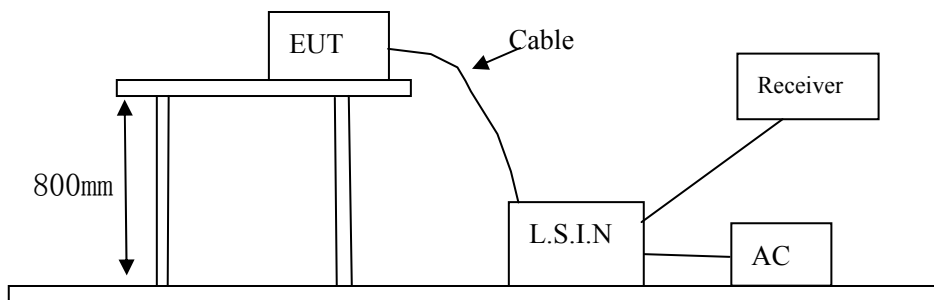

5.3 Configuration of The EUT

The EUT was configured according to ANSI C63.10-2013. All interface ports were connected to the appropriate peripherals. All peripherals and cables are listed below.

A. EUT

Device	Manufacturer	Model	FCC ID
Wireless Remote Control Outlet	Ningbo Free Trade Zone Rising Sun Electrical Co.,Ltd.	RSN011R, RSN021R	2A2XV-N1121

B. Internal Device

Device	Manufacturer	Model	FCC ID/DOC
N/A			

C. Peripherals

Device	Manufacturer	Model	Rating
N/A			

The report refers only to the sample tested and does not apply to the bulk.

This report is issued in confidence to the client and it will be strictly treated as such by the SHENZHEN TIMEWAY TESTING LABORATORIES. It may not be reproduced rather in its entirety or in part and it may not be used for adverting. The client to whom the report is issued may, however, show or send it . or a certified copy there of prepared by the SHENZHEN TIMEWAY TESTING LABORATORIES. to his customer. Supplier or others persons directly concerned. SHENZHEN TIMEWAY TESTING LABORATORIES. will not, without the consent of the client enter into any discussion of correspondence with any third party concerning the contents of the report.

In the event of the improper use of the report. The SHENZHEN TIMEWAY TESTING LABORATORIES. reserves the rights to withdraw it and to adopt any other remedies which may be appropriate.



5.4 EUT Operating Condition

Operating condition is according to ANSI C63.10-2013.

- A Setup the EUT and simulators as shown on follow
- B Enable AF signal and confirm EUT active to normal condition

5.5 Power line conducted Emission Limit according to Paragraph 15.207

Frequency (MHz)	Limits (dB $\mu$ V)	
	Quasi-peak Level	Average Level
0.15 ~ 0.50	66.0~56.0*	56.0~46.0*
0.50 ~ 5.00	56.0	46.0
5.00 ~ 30.00	60.0	50.0

- Notes:
- 1. \*Decreasing linearly with logarithm of frequency.
  - 2. The tighter limit shall apply at the transition frequencies

5.6 Test Results

The frequency spectrum from 0.15MHz to 30MHz was investigated. All reading are quasi-peak values with a resolution bandwidth of 9kHz.



**A: Conducted Emission on Live Terminal (150kHz to 30MHz)**

**EUT Operating Environment**

Temperature: 26°C Humidity: 65%RH Atmospheric Pressure: 101 kPa

**EUT set Condition: Keep WIFI Transmitting**

**Results: Pass**

Please refer to following diagram for individual

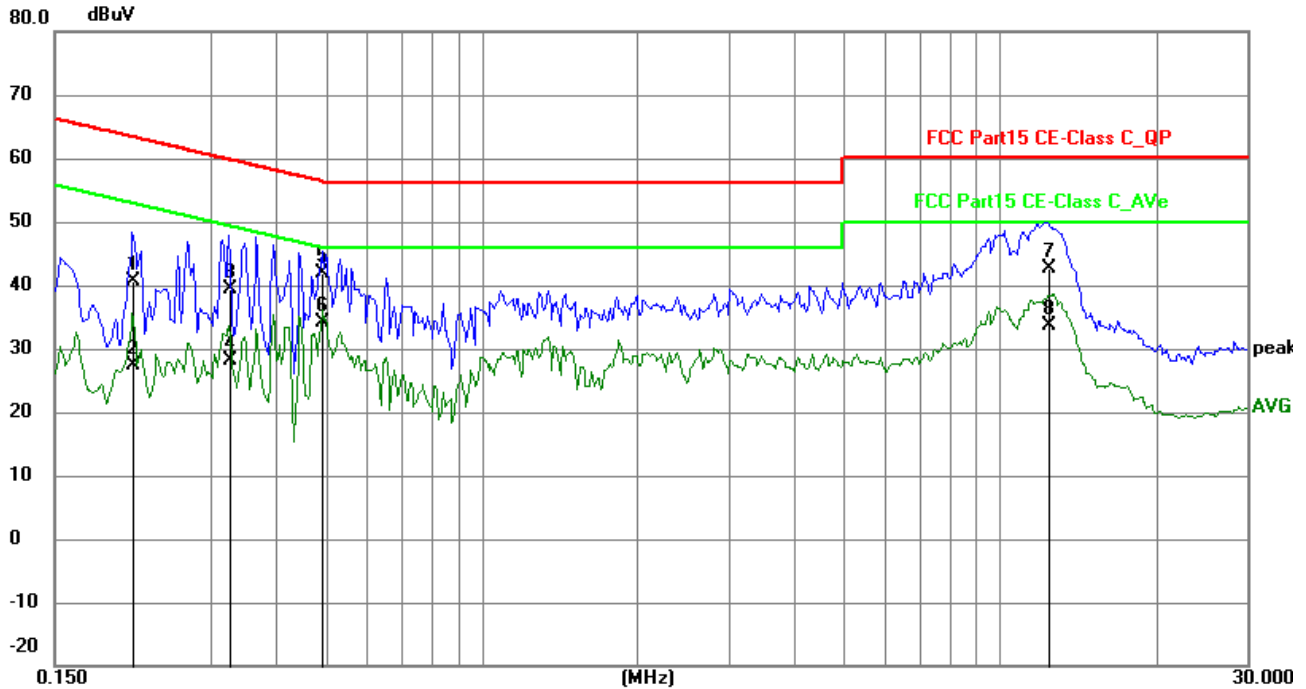

No.	Frequency (MHz)	Reading (dBuV)	Factor (dB)	Level (dBuV)	Limit (dBuV)	Margin (dB)	Detector	P/F
1	0.2124	30.87	9.75	40.62	63.11	-22.49	QP	P
2	0.2124	17.54	9.75	27.29	53.11	-25.82	AVG	P
3	0.3255	29.69	9.76	39.45	59.57	-20.12	QP	P
4	0.3255	18.33	9.76	28.09	49.57	-21.48	AVG	P
5	0.4932	32.10	9.77	41.87	56.11	-14.24	QP	P
6	0.4932	24.25	9.77	34.02	46.11	-12.09	AVG	P
7	12.4184	32.38	10.27	42.65	60.00	-17.35	QP	P
8	12.4184	23.26	10.27	33.53	50.00	-16.47	AVG	P

The report refers only to the sample tested and does not apply to the bulk.

This report is issued in confidence to the client and it will be strictly treated as such by the SHENZHEN TIMEWAY TESTING LABORATORIES. It may not be reproduced rather in its entirety or in part and it may not be used for advertising. The client to whom the report is issued may, however, show or send it or a certified copy thereof prepared by the SHENZHEN TIMEWAY TESTING LABORATORIES to his customer. Supplier or others persons directly concerned. SHENZHEN TIMEWAY TESTING LABORATORIES will not, without the consent of the client enter into any discussion of correspondence with any third party concerning the contents of the report.

In the event of the improper use of the report. The SHENZHEN TIMEWAY TESTING LABORATORIES reserves the rights to withdraw it and to adopt any other remedies which may be appropriate.



**B: Conducted Emission on Neutral Terminal (150kHz to 30MHz)**

**EUT Operating Environment**

Temperature: 26°C Humidity: 65%RH Atmospheric Pressure: 101 kPa

**EUT set Condition: Keep WIFI Transmitting**

**Results: Pass**

Please refer to following diagram for individual

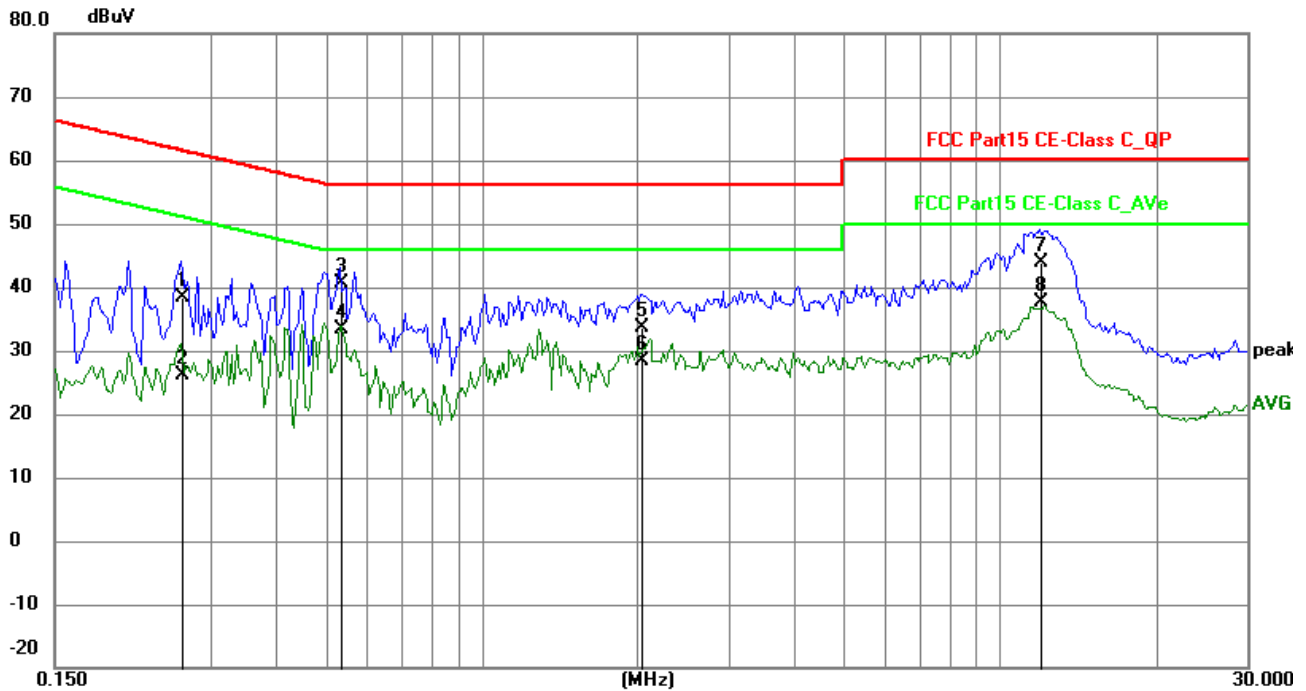

No.	Frequency (MHz)	Reading (dBuV)	Factor (dB)	Level (dBuV)	Limit (dBuV)	Margin (dB)	Detector	P/F
1	0.2631	28.53	9.75	38.28	61.33	-23.05	QP	P
2	0.2631	16.48	9.75	26.23	51.33	-25.10	AVG	P
3	0.5322	30.75	9.77	40.52	56.00	-15.48	QP	P
4	0.5322	23.57	9.77	33.34	46.00	-12.66	AVG	P
5	2.0259	23.90	9.80	33.70	56.00	-22.30	QP	P
6	2.0259	18.62	9.80	28.42	46.00	-17.58	AVG	P
7	11.9505	33.70	10.25	43.95	60.00	-16.05	QP	P
8	11.9505	27.32	10.25	37.57	50.00	-12.43	AVG	P

The report refers only to the sample tested and does not apply to the bulk.

This report is issued in confidence to the client and it will be strictly treated as such by the SHENZHEN TIMEWAY TESTING LABORATORIES. It may not be reproduced rather in its entirety or in part and it may not be used for advertising. The client to whom the report is issued may, however, show or send it . or a certified copy there of prepared by the SHENZHEN TIMEWAY TESTING LABORATORIES. to his customer. Supplier or others persons directly concerned. SHENZHEN TIMEWAY TESTING LABORATORIES. will not, without the consent of the client enter into any discussion of correspondence with any third party concerning the contents of the report.

In the event of the improper use of the report. The SHENZHEN TIMEWAY TESTING LABORATORIES. reserves the rights to withdraw it and to adopt any other remedies which may be appropriate.

## 6 Radiated Emission Test

### 6.1 Test Method and test Procedure:

- (1) The EUT was tested according to ANSI C63.10-2013. The radiated test was performed at Timeway EMC Laboratory. This site is on file with the FCC laboratory division, Registration No. 744189
- (2) The EUT, peripherals were put on the turntable which table size is 1m x 1.5 m, table high 0.8 m. All set up is according to ANSI C63.10-2013.
- (3) The frequency spectrum from 30 MHz to 25 GHz was investigated. All readings from 30 MHz to 1 GHz are Quasi-peak values with a resolution bandwidth of 120 kHz. For measurement above 1GHz, peak values with RBW=1MHz VBW=3MHz and PK detector. AV value with RBW=1MHz, VBW=3MHz and RMS detector. Measurements were made at 3 meters.
- (4) The antenna high is varied from 1 m to 4 m high to find the maximum emission for each frequency.
- (5) Maximizing procedure was performed on the six (6) highest emissions to ensure EUT compliance is with all installation combinations. All data was recorded in the peak detection mode. Quasi-peak readings was performed only when an emission was found to be marginal (within -4 dB of specification limit), and are distinguished with a “QP” in the data table.
- (6) The antenna polarization : Vertical polarization and Horizontal polarization.

### Block diagram of Test setup

For radiated emissions from 9kHz to 30MHz

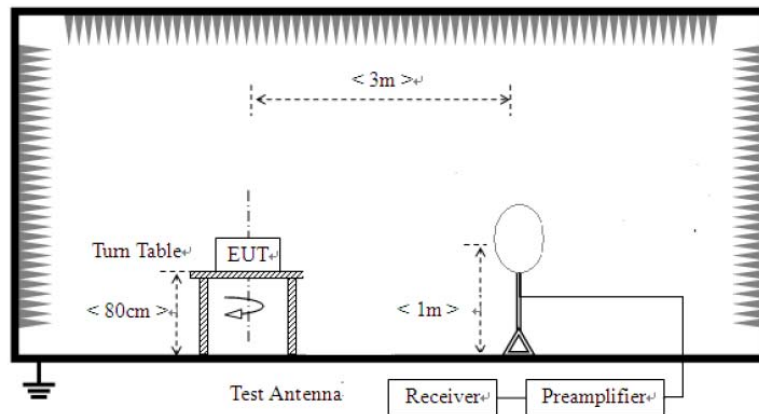

The report refers only to the sample tested and does not apply to the bulk.

This report is issued in confidence to the client and it will be strictly treated as such by the SHENZHEN TIMEWAY TESTING LABORATORIES. It may not be reproduced rather in its entirety or in part and it may not be used for advertising. The client to whom the report is issued may, however, show or send it, or a certified copy thereof prepared by the SHENZHEN TIMEWAY TESTING LABORATORIES, to his customer. Supplier or others persons directly concerned. SHENZHEN TIMEWAY TESTING LABORATORIES, will not, without the consent of the client enter into any discussion of correspondence with any third party concerning the contents of the report.

In the event of the improper use of the report. The SHENZHEN TIMEWAY TESTING LABORATORIES, reserves the rights to withdraw it and to adopt any other remedies which may be appropriate.

For radiated emissions from 30MHz to 1GHz

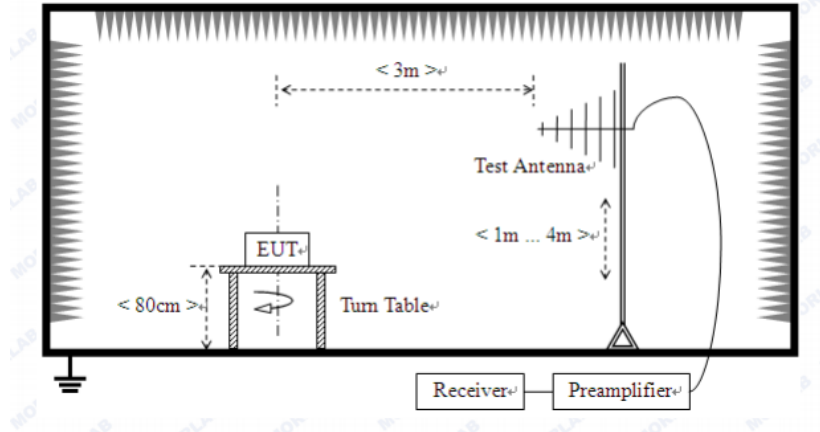

For radiated emissions above 1GHz

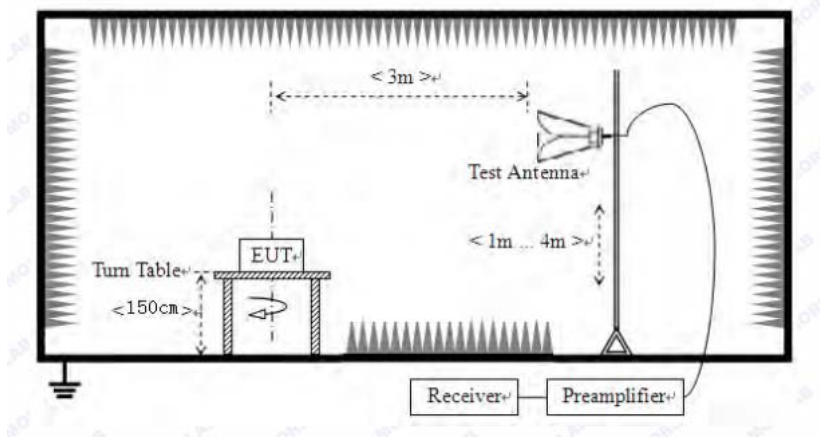

## 6.2 Configuration of The EUT

Same as section 5.3 of this report

## 6.3 EUT Operating Condition

Same as section 5.4 of this report.

## 6.4 Radiated Emission Limit

All emission from a digital device, including any network of conductors and apparatus connected thereto, shall not exceed the level of field strength specified below:

The report refers only to the sample tested and does not apply to the bulk.

This report is issued in confidence to the client and it will be strictly treated as such by the SHENZHEN TIMEWAY TESTING LABORATORIES. It may not be reproduced in its entirety or in part and it may not be used for advertising. The client to whom the report is issued may, however, show or send it, or a certified copy thereof prepared by the SHENZHEN TIMEWAY TESTING LABORATORIES, to his customer, supplier or other persons directly concerned. SHENZHEN TIMEWAY TESTING LABORATORIES, will not, without the consent of the client enter into any discussion of correspondence with any third party concerning the contents of the report.

In the event of the improper use of the report, the SHENZHEN TIMEWAY TESTING LABORATORIES, reserves the rights to withdraw it and to adopt any other remedies which may be appropriate.



**Frequencies in restricted band are complied to limit on Paragraph 15.209**

Frequency Range (MHz)	Distance (m)	Field strength (dB $\mu$ V/m)
30-88	3	40.0
88-216	3	43.5
216-960	3	46.0
Above 960	3	54.0

- Note:
1. RF Voltage (dBuV) = 20 log RF Voltage (uV)
  2. In the Above Table, the higher limit applies at the band edges.
  3. Distance refers to the distance in meters between the measuring instrument antenna and the EUT
  4. **Worse case were recorded in the test report. 802.11g was the worst case.**

The report refers only to the sample tested and does not apply to the bulk.  
This report is issued in confidence to the client and it will be strictly treated as such by the SHENZHEN TIMEWAY TESTING LABORATORIES. It may not be reproduced rather in its entirety or in part and it may not be used for adverting. The client to whom the report is issued may, however, show or send it . or a certified copy there of prepared by the SHENZHEN TIMEWAY TESTING LABORATORIES. to his customer. Supplier or others persons directly concerned. SHENZHEN TIMEWAY TESTING LABORATORIES. will not, without the consent of the client enter into any discussion of correspondence with any third party concerning the contents of the report.  
In the event of the improper use of the report. The SHENZHEN TIMEWAY TESTING LABORATORIES. reserves the rights to withdraw it and to adopt any other remedies which may be appropriate.



**Test result**

**General Radiated Emission Data and Harmonics Radiated Emission Data**

**Radiated Emission In Horizontal (30MHz----1000MHz)**

EUT set Condition: **Keep Transmitting**

Results: **Pass**

FCC\_FCC Part 15C Class B 30MHz-1GHz

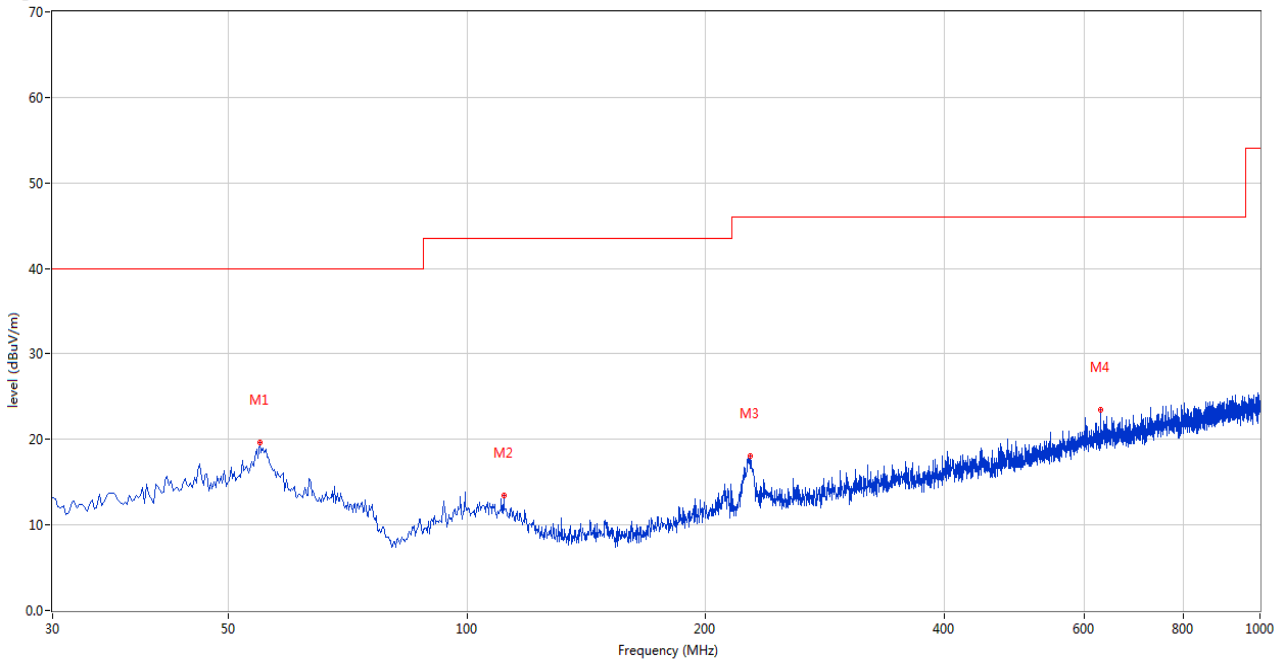

No.	Frequency (MHz)	Results (dBuV/m)	Factor (dB)	Limit (dBuV/m)	Over Limit (dB)	Detector	Table (o)	Height (cm)	ANT	Verdict
1	54.729	19.66	-11.72	40.0	-20.34	Peak	338.00	100	Horizontal	Pass
2	111.217	13.44	-13.67	43.5	-30.06	Peak	222.00	100	Horizontal	Pass
3	227.346	18.06	-12.79	46.0	-27.94	Peak	341.00	100	Horizontal	Pass
4	629.553	23.43	-5.03	46.0	-22.57	Peak	338.00	100	Horizontal	Pass

The report refers only to the sample tested and does not apply to the bulk.

This report is issued in confidence to the client and it will be strictly treated as such by the SHENZHEN TIMEWAY TESTING LABORATORIES. It may not be reproduced rather in its entirety or in part and it may not be used for advertizing. The client to whom the report is issued may, however, show or send it . or a certified copy there of prepared by the SHENZHEN TIMEWAY TESTING LABORATORIES. to his customer. Supplier or others persons directly concerned. SHENZHEN TIMEWAY TESTING LABORATORIES. will not, without the consent of the client enter into any discussion of correspondence with any third party concerning the contents of the report.

In the event of the improper use of the report. The SHENZHEN TIMEWAY TESTING LABORATORIES. reserves the rights to withdraw it and to adopt any other remedies which may be appropriate.





**Test result**

**General Radiated Emission Data and Harmonics Radiated Emission Data**

**Radiated Emission In Vertical (30MHz----1000MHz)**

EUT set Condition: **Keep Transmitting**

Results: **Pass**

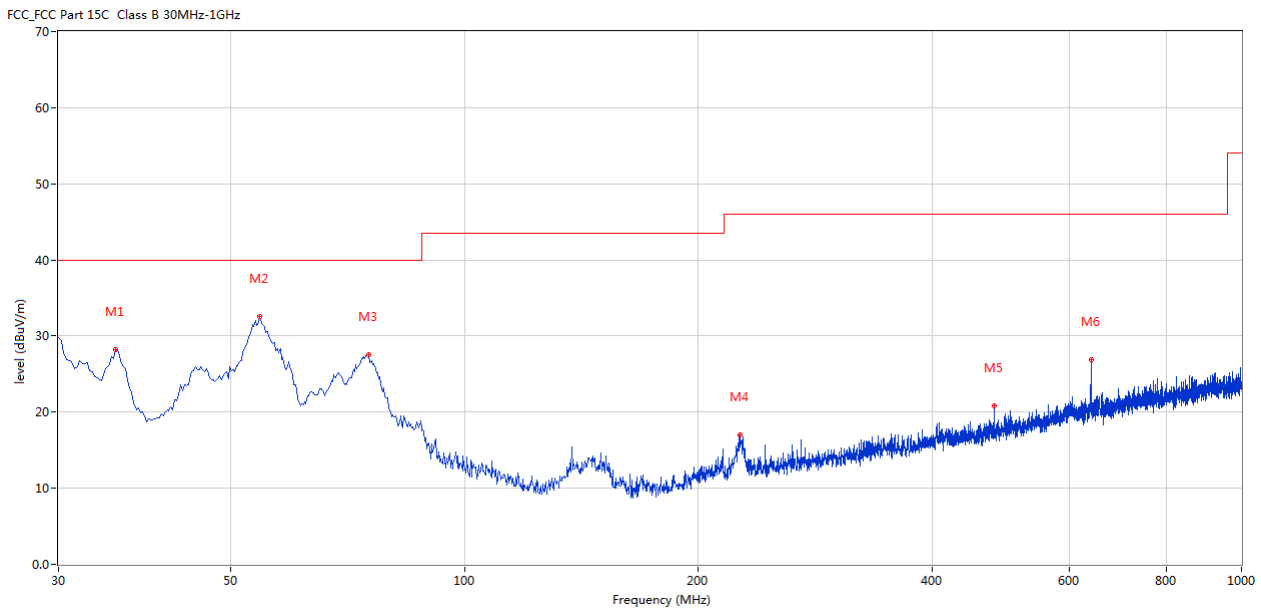

No.	Frequency (MHz)	Results (dBuV/m)	Factor (dB)	Limit (dBuV/m)	Over Limit (dB)	Detector	Table (o)	Height (cm)	ANT	Verdict
1	35.576	28.20	-13.84	40.0	-11.80	Peak	292.00	100	Vertical	Pass
2	54.486	32.52	-11.66	40.0	-7.48	Peak	360.00	100	Vertical	Pass
3	75.336	27.54	-17.38	40.0	-12.46	Peak	44.00	100	Vertical	Pass
4	225.891	17.04	-12.85	46.0	-28.96	Peak	32.00	100	Vertical	Pass
5	479.968	20.83	-7.40	46.0	-25.17	Peak	169.00	100	Vertical	Pass
6	639.978	26.88	-4.77	46.0	-19.12	Peak	309.00	100	Vertical	Pass

The report refers only to the sample tested and does not apply to the bulk.

This report is issued in confidence to the client and it will be strictly treated as such by the SHENZHEN TIMEWAY TESTING LABORATORIES. It may not be reproduced rather in its entirety or in part and it may not be used for advertising. The client to whom the report is issued may, however, show or send it or a certified copy thereof prepared by the SHENZHEN TIMEWAY TESTING LABORATORIES to his customer. Supplier or others persons directly concerned. SHENZHEN TIMEWAY TESTING LABORATORIES will not, without the consent of the client enter into any discussion of correspondence with any third party concerning the contents of the report.

In the event of the improper use of the report. The SHENZHEN TIMEWAY TESTING LABORATORIES reserves the rights to withdraw it and to adopt any other remedies which may be appropriate.



Please refer to the following test plots for details:

**CH01 for 11g at 6Mbps: Horizontal**

FCC Part 15C Class B 1GHz-18GHz -2

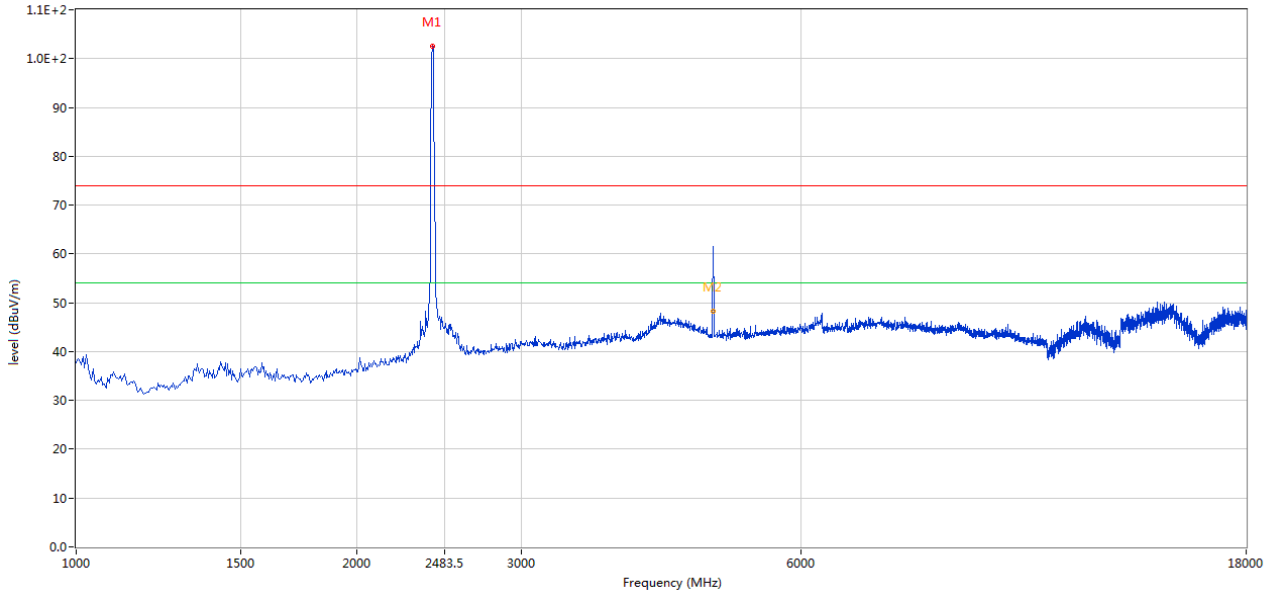

No.	Frequency (MHz)	Results (dBuV/m)	Factor (dB)	Limit (dBuV/m)	Over Limit (dB)	Detector	Table (o)	Height (cm)	ANT	Verdict
2	4824.044	62.13	3.14	74.0	-11.87	Peak	192.00	100	Horizontal	Pass
2**	4824.044	48.37	3.14	54.0	-5.63	AV	192.00	100	Horizontal	Pass

The report refers only to the sample tested and does not apply to the bulk.

This report is issued in confidence to the client and it will be strictly treated as such by the SHENZHEN TIMEWAY TESTING LABORATORIES. It may not be reproduced rather in its entirety or in part and it may not be used for advertising. The client to whom the report is issued may, however, show or send it or a certified copy thereof prepared by the SHENZHEN TIMEWAY TESTING LABORATORIES to his customer. Supplier or others persons directly concerned. SHENZHEN TIMEWAY TESTING LABORATORIES will not, without the consent of the client enter into any discussion of correspondence with any third party concerning the contents of the report.

In the event of the improper use of the report. The SHENZHEN TIMEWAY TESTING LABORATORIES reserves the rights to withdraw it and to adopt any other remedies which may be appropriate.



**CH01 for 11g at 6Mbps: Vertical**

FCC Part 15C Class B 1GHz-18GHz -2

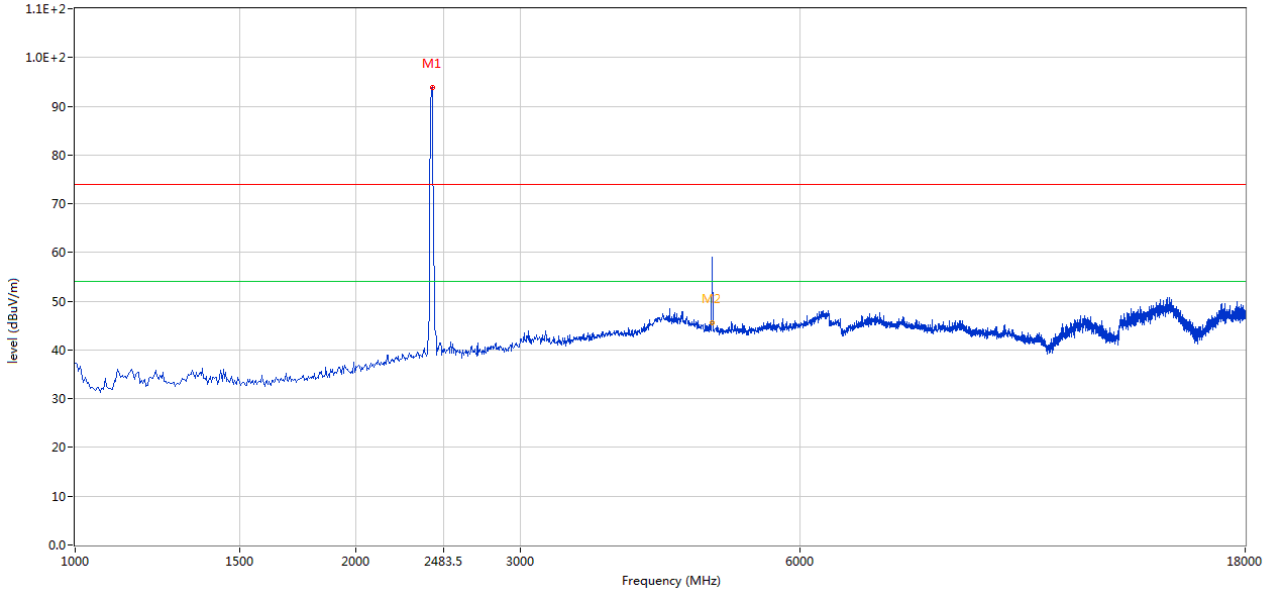

No.	Frequency (MHz)	Results (dBuV/m)	Factor (dB)	Limit (dBuV/m)	Over Limit (dB)	Detector	Table (o)	Height (cm)	ANT	Verdict
2	4824.044	58.91	3.14	74.0	-15.09	Peak	124.00	100	Vertical	Pass
2**	4824.044	45.49	3.14	54.0	-8.51	AV	124.00	100	Vertical	Pass

The report refers only to the sample tested and does not apply to the bulk.

This report is issued in confidence to the client and it will be strictly treated as such by the SHENZHEN TIMEWAY TESTING LABORATORIES. It may not be reproduced rather in its entirety or in part and it may not be used for advertising. The client to whom the report is issued may, however, show or send it . or a certified copy there of prepared by the SHENZHEN TIMEWAY TESTING LABORATORIES. to his customer. Supplier or others persons directly concerned. SHENZHEN TIMEWAY TESTING LABORATORIES. will not, without the consent of the client enter into any discussion of correspondence with any third party concerning the contents of the report.

In the event of the improper use of the report. The SHENZHEN TIMEWAY TESTING LABORATORIES. reserves the rights to withdraw it and to adopt any other remedies which may be appropriate.



**CH06 for 11g at 6Mbps: Horizontal**

FCC Part 15C Class B 1GHz-18GHz -2

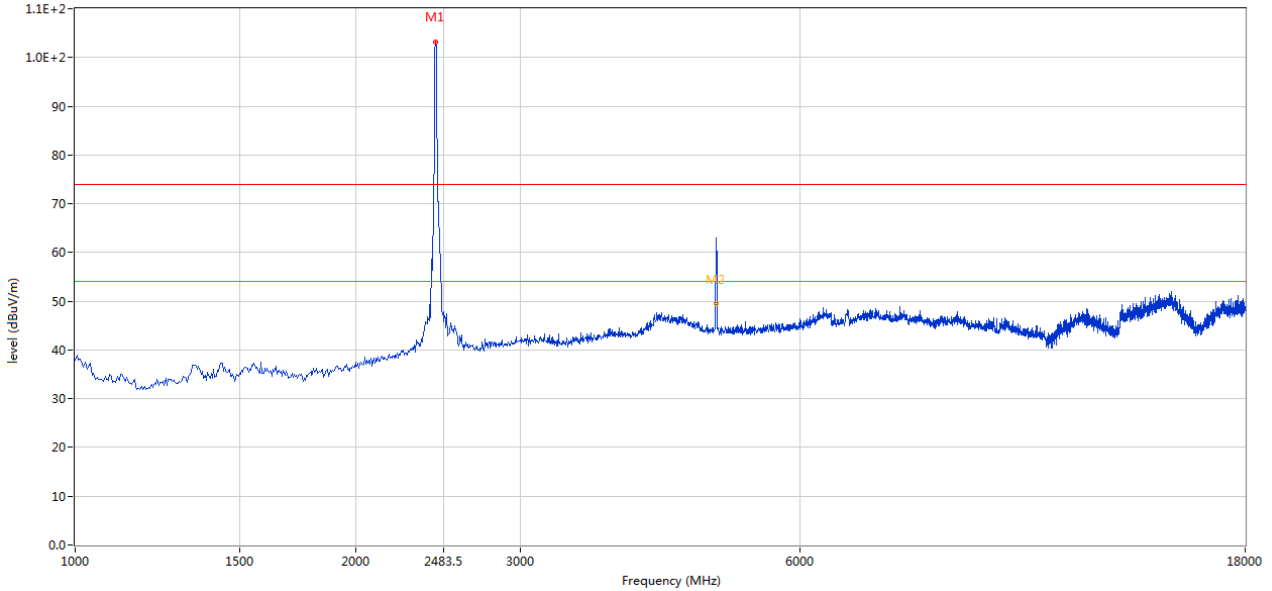

No.	Frequency (MHz)	Results (dBuV/m)	Factor (dB)	Limit (dBuV/m)	Over Limit (dB)	Detector	Table (o)	Height (cm)	ANT	Verdict
2	4875.031	63.82	3.19	74.0	-10.18	Peak	217.00	100	Horizontal	Pass
2**	4875.031	49.52	3.19	54.0	-4.48	AV	217.00	100	Horizontal	Pass

The report refers only to the sample tested and does not apply to the bulk.

This report is issued in confidence to the client and it will be strictly treated as such by the SHENZHEN TIMEWAY TESTING LABORATORIES. It may not be reproduced rather in its entirety or in part and it may not be used for advertizing. The client to whom the report is issued may, however, show or send it . or a certified copy there of prepared by the SHENZHEN TIMEWAY TESTING LABORATORIES. to his customer. Supplier or others persons directly concerned. SHENZHEN TIMEWAY TESTING LABORATORIES. will not, without the consent of the client enter into any discussion of correspondence with any third party concerning the contents of the report.

In the event of the improper use of the report. The SHENZHEN TIMEWAY TESTING LABORATORIES. reserves the rights to withdraw it and to adopt any other remedies which may be appropriate.



**CH06 for 11g at 6Mbps: Vertical**

FCC Part 15C Class B 1GHz-18GHz -2

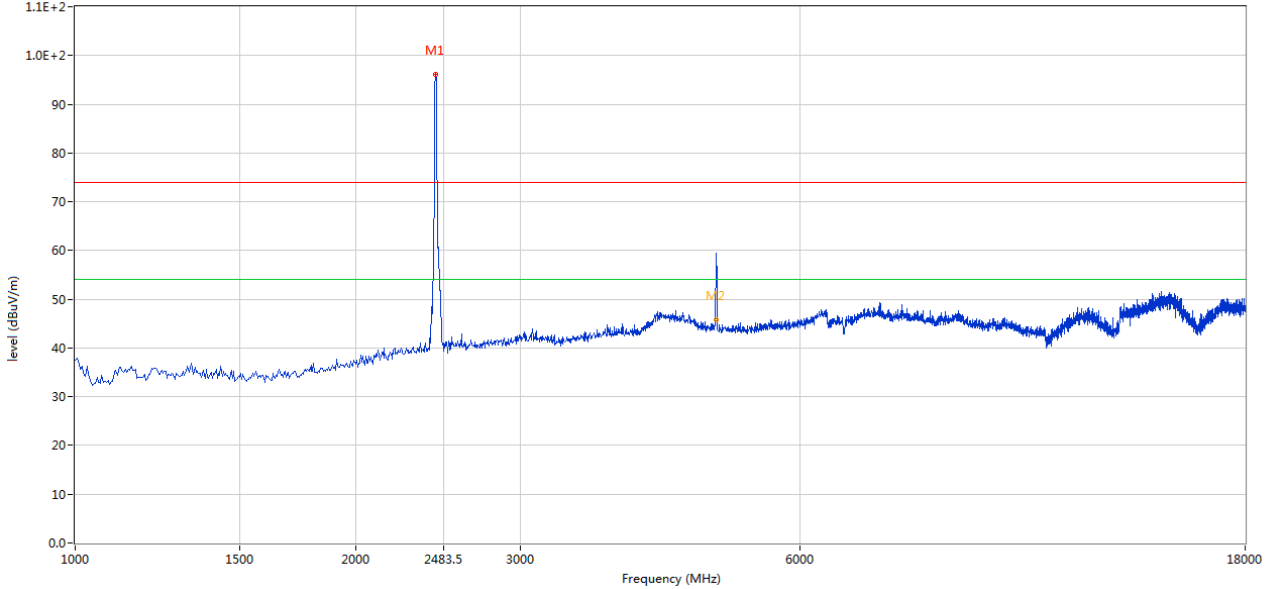

No.	Frequency (MHz)	Results (dBuV/m)	Factor (dB)	Limit (dBuV/m)	Over Limit (dB)	Detector	Table (o)	Height (cm)	ANT	Verdict
2	4875.031	59.38	3.19	74.0	-14.62	Peak	155.00	100	Vertical	Pass
2**	4875.031	45.86	3.19	54.0	-8.14	AV	155.00	100	Vertical	Pass

The report refers only to the sample tested and does not apply to the bulk.

This report is issued in confidence to the client and it will be strictly treated as such by the SHENZHEN TIMEWAY TESTING LABORATORIES. It may not be reproduced rather in its entirety or in part and it may not be used for advertising. The client to whom the report is issued may, however, show or send it or a certified copy thereof prepared by the SHENZHEN TIMEWAY TESTING LABORATORIES to his customer. Supplier or others persons directly concerned. SHENZHEN TIMEWAY TESTING LABORATORIES will not, without the consent of the client enter into any discussion of correspondence with any third party concerning the contents of the report.

In the event of the improper use of the report. The SHENZHEN TIMEWAY TESTING LABORATORIES reserves the rights to withdraw it and to adopt any other remedies which may be appropriate.



**CH11 for 11g at 6Mbps: Horizontal**

FCC Part 15C Class B 1GHz-18GHz -2

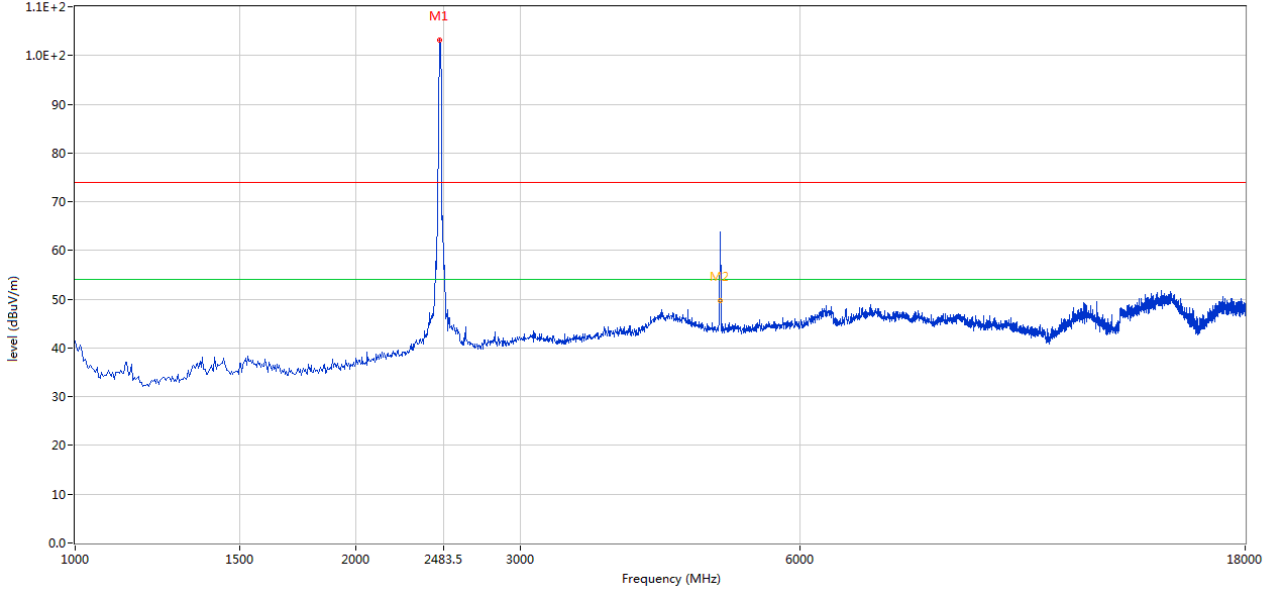

No	Frequency (MHz)	Results (dBuV/m)	Factor (dB)	Limit (dBuV/m)	Over Limit (dB)	Detector	Table (o)	Height (cm)	ANT	Verdict
2	4921.770	64.08	3.27	74.0	-9.92	Peak	213.00	100	Horizontal	Pass
2**	4921.770	49.80	3.27	54.0	-4.20	AV	213.00	100	Horizontal	Pass

The report refers only to the sample tested and does not apply to the bulk.

This report is issued in confidence to the client and it will be strictly treated as such by the SHENZHEN TIMEWAY TESTING LABORATORIES. It may not be reproduced rather in its entirety or in part and it may not be used for adverting. The client to whom the report is issued may, however, show or send it . or a certified copy there of prepared by the SHENZHEN TIMEWAY TESTING LABORATORIES. to his customer. Supplier or others persons directly concerned. SHENZHEN TIMEWAY TESTING LABORATORIES. will not, without the consent of the client enter into any discussion of correspondence with any third party concerning the contents of the report.

In the event of the improper use of the report. The SHENZHEN TIMEWAY TESTING LABORATORIES. reserves the rights to withdraw it and to adopt any other remedies which may be appropriate.



**CH11 for 11g at 6Mbps: Vertical**

FCC Part 15C Class B 1GHz-18GHz -2

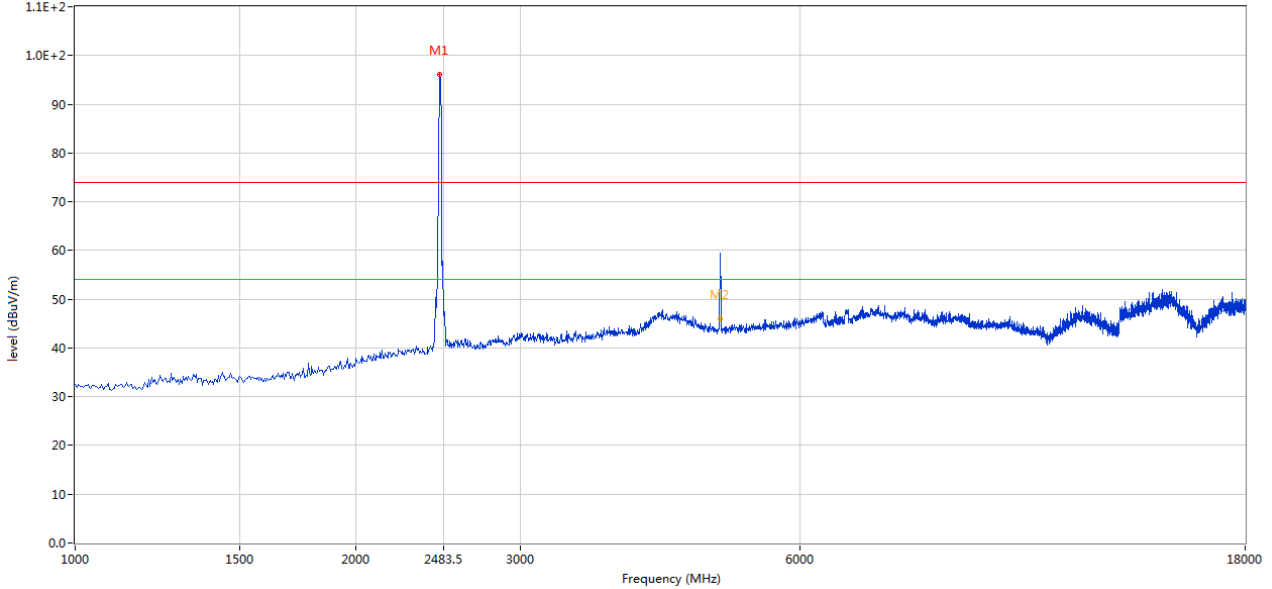

No.	Frequency (MHz)	Results (dBuV/m)	Factor (dB)	Limit (dBuV/m)	Over Limit (dB)	Detector	Table (o)	Height (cm)	ANT	Verdict
2	4921.770	59.12	3.27	74.0	-14.78	Peak	150.00	100	Vertical	Pass
2**	4921.770	45.94	3.27	54.0	-8.06	AV	150.00	100	Vertical	Pass

Note: 1. Result Level = Reading + Factor

2. Factor= AF + Cable Loss- Preamp

3. Margin = Result- Limit

4. For radiated Emissions from 18-25GHz and below 30MHz, it is only the floor noise.

5. The peak value less than the AV limit, no necessary to take down the AV measurement result.

The report refers only to the sample tested and does not apply to the bulk.

This report is issued in confidence to the client and it will be strictly treated as such by the SHENZHEN TIMEWAY TESTING LABORATORIES. It may not be reproduced rather in its entirety or in part and it may not be used for adverting. The client to whom the report is issued may, however, show or send it . or a certified copy there of prepared by the SHENZHEN TIMEWAY TESTING LABORATORIES. to his customer. Supplier or others persons directly concerned. SHENZHEN TIMEWAY TESTING LABORATORIES. will not, without the consent of the client enter into any discussion of correspondence with any third party concerning the contents of the report.

In the event of the improper use of the report. The SHENZHEN TIMEWAY TESTING LABORATORIES. reserves the rights to withdraw it and to adopt any other remedies which may be appropriate.



## 7.0 6dB Bandwidth Measurement

### 7.1 Test Setup

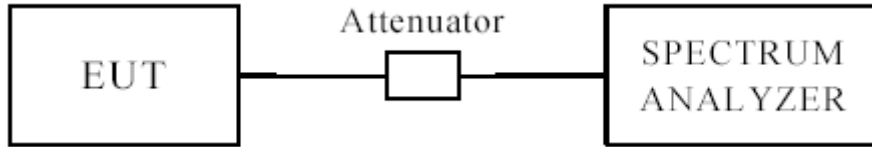

### 7.2 Limits of 6dB Bandwidth Measurement

The minimum of 6dB Bandwidth Measurement is >500 kHz

### 7.3 Test Procedure

1. Set resolution bandwidth (RBW) = 100 kHz
2. Set the video bandwidth (VBW)  $\geq 3 \times$  RBW.
3. Detector = Peak.
4. Trace mode = max hold.
5. Sweep = auto couple.
6. Allow the trace to stabilize.
7. Measure the maximum width of the emission that is constrained by the frequencies associated with the two outermost amplitude points (upper and lower) that are attenuated by 6 dB relative to the maximum level measured in the fundamental emission.

### 7.4 Test Result

The report refers only to the sample tested and does not apply to the bulk.

This report is issued in confidence to the client and it will be strictly treated as such by the SHENZHEN TIMEWAY TESTING LABORATORIES. It may not be reproduced rather in its entirety or in part and it may not be used for advertising. The client to whom the report is issued may, however, show or send it or a certified copy thereof prepared by the SHENZHEN TIMEWAY TESTING LABORATORIES to his customer. Supplier or others persons directly concerned. SHENZHEN TIMEWAY TESTING LABORATORIES will not, without the consent of the client enter into any discussion of correspondence with any third party concerning the contents of the report.

In the event of the improper use of the report. The SHENZHEN TIMEWAY TESTING LABORATORIES reserves the rights to withdraw it and to adopt any other remedies which may be appropriate.





**6dB Occupied Bandwidth**

EUT		Wireless Remote Control Outlet		Model	RSN011R
Mode		802.11b		Input Voltage	120V~
Temperature		24 deg. C,		Humidity	56% RH
Channel	Channel Frequency (MHz)	Data Transfer Rate (Mbps)	6 dB Bandwidth (MHz)	Minimum Limit (MHz)	Pass/ Fail
1	2412	1	10.04	0.5	Pass
6	2437	1	10.04	0.5	Pass
11	2462	1	10.04	0.5	Pass
1	2412	11	10.04	0.5	Pass
6	2437	11	10.04	0.5	Pass
11	2462	11	10.04	0.5	Pass

The report refers only to the sample tested and does not apply to the bulk.  
 This report is issued in confidence to the client and it will be strictly treated as such by the SHENZHEN TIMEWAY TESTING LABORATORIES. It may not be reproduced rather in its entirety or in part and it may not be used for advertising. The client to whom the report is issued may, however, show or send it or a certified copy thereof prepared by the SHENZHEN TIMEWAY TESTING LABORATORIES to his customer. Supplier or others persons directly concerned. SHENZHEN TIMEWAY TESTING LABORATORIES will not, without the consent of the client enter into any discussion of correspondence with any third party concerning the contents of the report.  
 In the event of the improper use of the report. The SHENZHEN TIMEWAY TESTING LABORATORIES reserves the rights to withdraw it and to adopt any other remedies which may be appropriate.



1. 802.11b at 1Mbps of CH01

	Delta 1 [T1]	RBW	100 kHz	RF Att	20 dB
	Ref Lvl	-0.01 dB	VBW	300 kHz	
	10 dBm	10.04008016 MHz	SWT	7.5 ms	Unit dBm

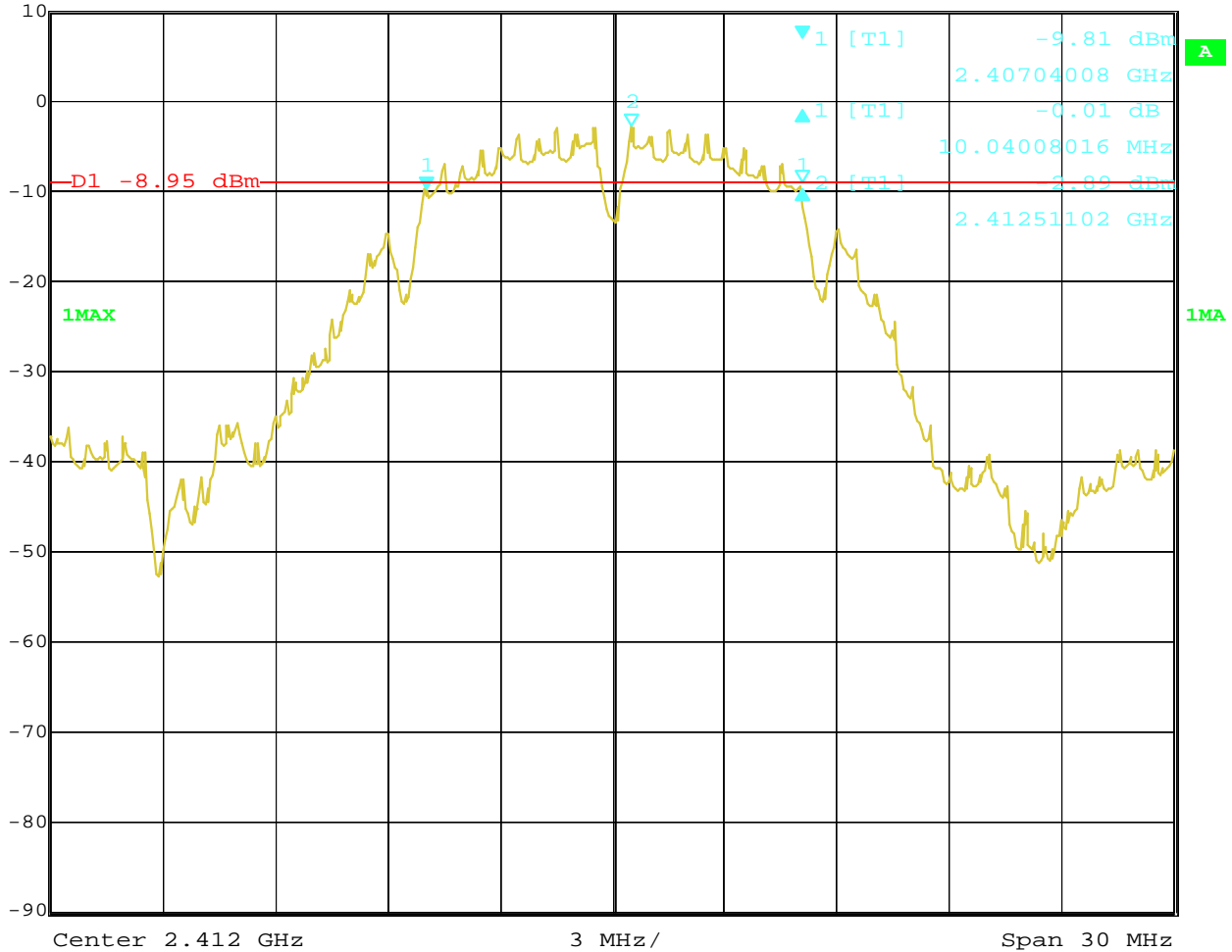

Date: 29.SEP.2021 10:20:52

The report refers only to the sample tested and does not apply to the bulk.  
 This report is issued in confidence to the client and it will be strictly treated as such by the SHENZHEN TIMEWAY TESTING LABORATORIES. It may not be reproduced rather in its entirety or in part and it may not be used for adverting. The client to whom the report is issued may, however, show or send it . or a certified copy there of prepared by the SHENZHEN TIMEWAY TESTING LABORATORIES. to his customer. Supplier or others persons directly concerned. SHENZHEN TIMEWAY TESTING LABORATORIES. will not, without the consent of the client enter into any discussion of correspondence with any third party concerning the contents of the report.  
 In the event of the improper use of the report. The SHENZHEN TIMEWAY TESTING LABORATORIES. reserves the rights to withdraw it and to adopt any other remedies which may be appropriate.



2. 802.11b at 1Mbps of CH06



Ref Lvl	Delta 1 [T1]	RBW	100 kHz	RF Att	20 dB
10 dBm	0.86 dB	VBW	300 kHz	Unit	dBm
	10.04008016 MHz	SWT	7.5 ms		

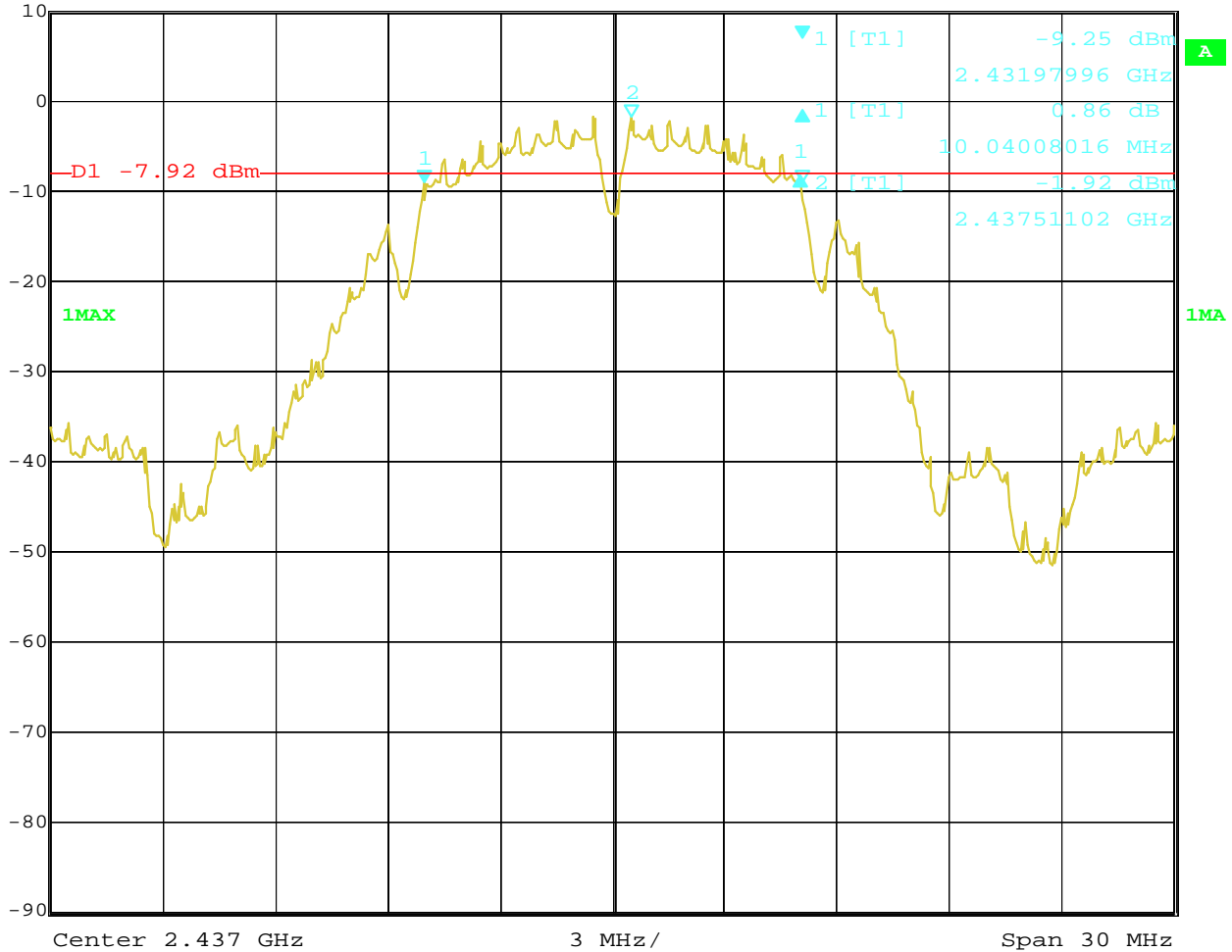

Date: 29.SEP.2021 10:26:40

The report refers only to the sample tested and does not apply to the bulk.  
 This report is issued in confidence to the client and it will be strictly treated as such by the SHENZHEN TIMEWAY TESTING LABORATORIES. It may not be reproduced rather in its entirety or in part and it may not be used for advertising. The client to whom the report is issued may, however, show or send it . or a certified copy there of prepared by the SHENZHEN TIMEWAY TESTING LABORATORIES. to his customer. Supplier or others persons directly concerned. SHENZHEN TIMEWAY TESTING LABORATORIES. will not, without the consent of the client enter into any discussion of correspondence with any third party concerning the contents of the report.  
 In the event of the improper use of the report. The SHENZHEN TIMEWAY TESTING LABORATORIES. reserves the rights to withdraw it and to adopt any other remedies which may be appropriate.



3. 802.11b at 1Mbps of CH11

	Delta 1 [T1]	RBW	100 kHz	RF Att	20 dB
	Ref Lvl	0.57 dB	VBW	300 kHz	
	10 dBm	10.04008016 MHz	SWT	7.5 ms	Unit dBm

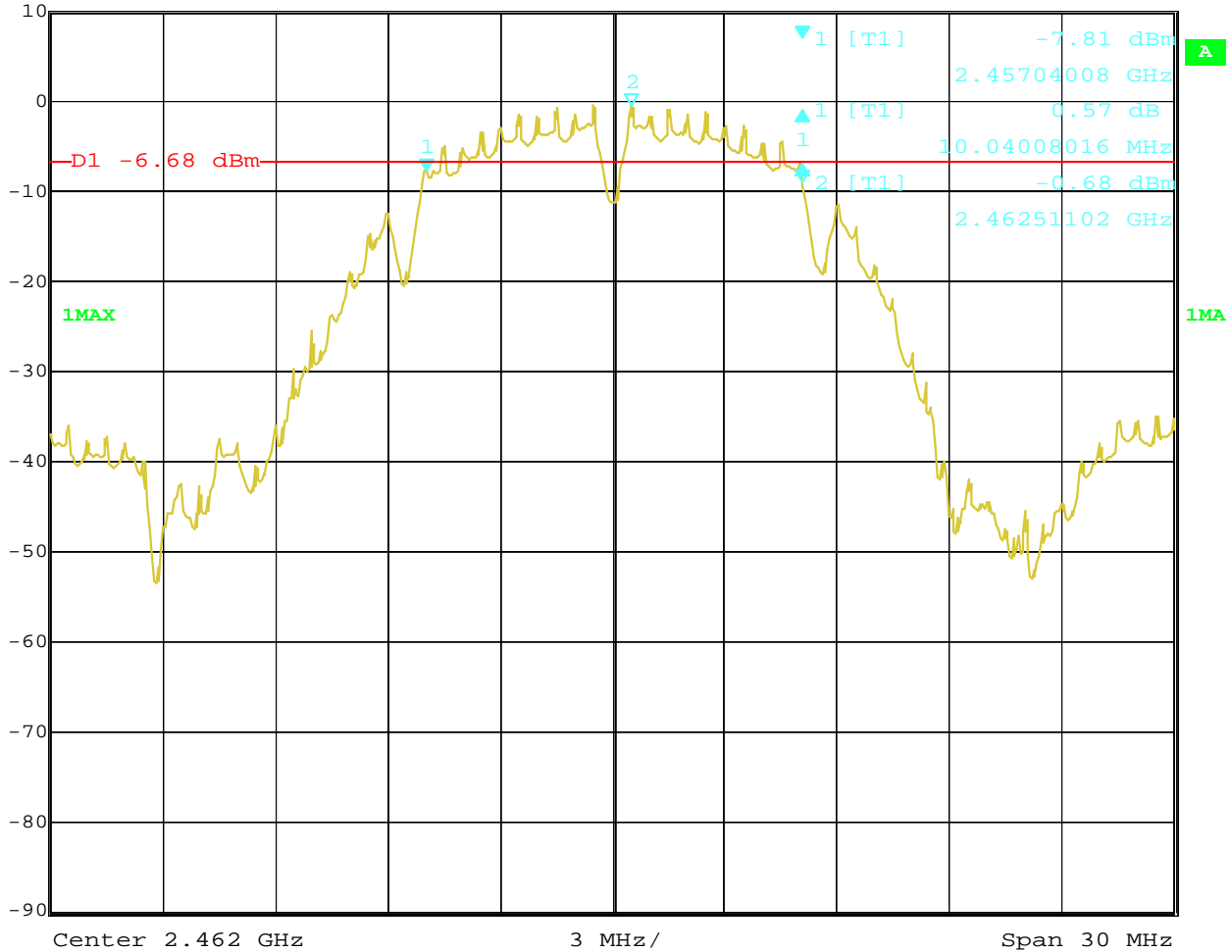

Date: 29.SEP.2021 10:30:52

The report refers only to the sample tested and does not apply to the bulk.  
 This report is issued in confidence to the client and it will be strictly treated as such by the SHENZHEN TIMEWAY TESTING LABORATORIES. It may not be reproduced rather in its entirety or in part and it may not be used for advertising. The client to whom the report is issued may, however, show or send it or a certified copy thereof prepared by the SHENZHEN TIMEWAY TESTING LABORATORIES to his customer. Supplier or others persons directly concerned. SHENZHEN TIMEWAY TESTING LABORATORIES will not, without the consent of the client enter into any discussion of correspondence with any third party concerning the contents of the report.  
 In the event of the improper use of the report. The SHENZHEN TIMEWAY TESTING LABORATORIES reserves the rights to withdraw it and to adopt any other remedies which may be appropriate.



4. 802.11b at 11Mbps of CH01

	Delta 1 [T1]	RBW	100 kHz	RF Att	20 dB
	Ref Lvl	0.20 dB	VBW	300 kHz	
	10 dBm	10.04008016 MHz	SWT	7.5 ms	Unit dBm

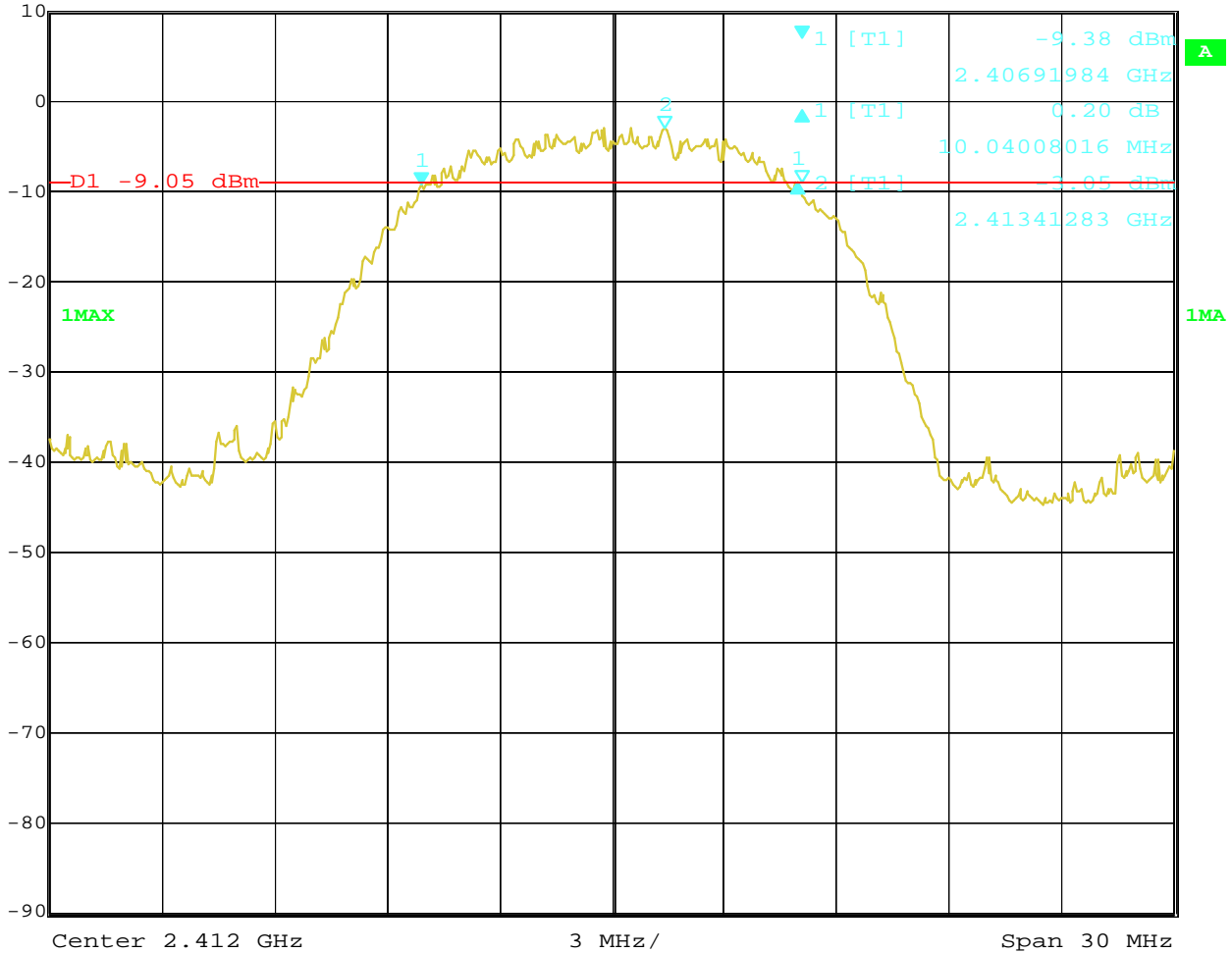

Date: 29.SEP.2021 11:06:07

The report refers only to the sample tested and does not apply to the bulk.  
 This report is issued in confidence to the client and it will be strictly treated as such by the SHENZHEN TIMEWAY TESTING LABORATORIES. It may not be reproduced rather in its entirety or in part and it may not be used for adverting. The client to whom the report is issued may, however, show or send it . or a certified copy there of prepared by the SHENZHEN TIMEWAY TESTING LABORATORIES. to his customer. Supplier or others persons directly concerned. SHENZHEN TIMEWAY TESTING LABORATORIES. will not, without the consent of the client enter into any discussion of correspondence with any third party concerning the contents of the report.  
 In the event of the improper use of the report. The SHENZHEN TIMEWAY TESTING LABORATORIES. reserves the rights to withdraw it and to adopt any other remedies which may be appropriate.



5. 802.11b at 11Mbps of CH06

	Delta 1 [T1]	RBW	100 kHz	RF Att	20 dB
	Ref Lvl	0.62 dB	VBW	300 kHz	
	10 dBm	10.04008016 MHz	SWT	7.5 ms	Unit dBm

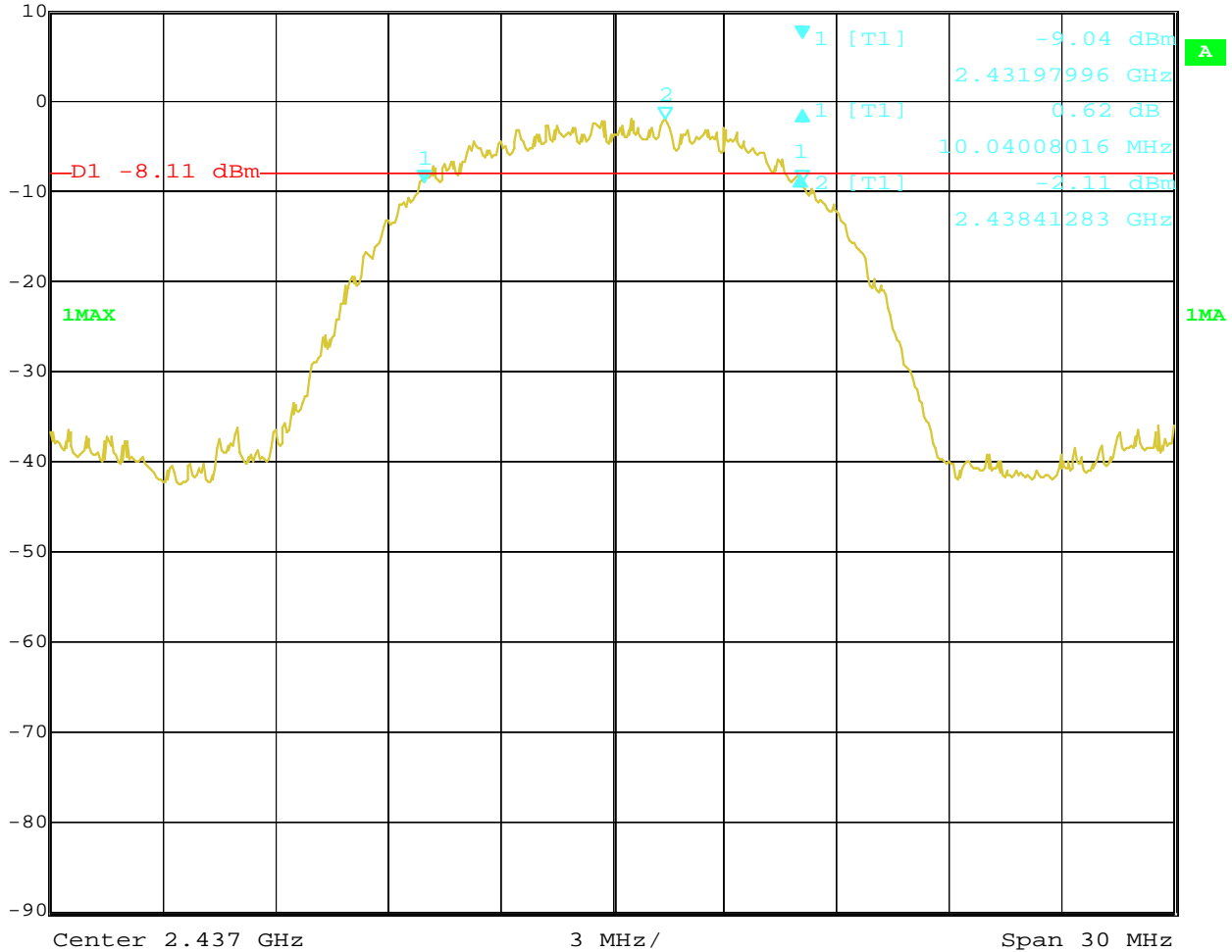

Date: 29.SEP.2021 11:08:25

The report refers only to the sample tested and does not apply to the bulk.  
 This report is issued in confidence to the client and it will be strictly treated as such by the SHENZHEN TIMEWAY TESTING LABORATORIES. It may not be reproduced rather in its entirety or in part and it may not be used for adverting. The client to whom the report is issued may, however, show or send it . or a certified copy there of prepared by the SHENZHEN TIMEWAY TESTING LABORATORIES. to his customer. Supplier or others persons directly concerned. SHENZHEN TIMEWAY TESTING LABORATORIES. will not, without the consent of the client enter into any discussion of correspondence with any third party concerning the contents of the report.  
 In the event of the improper use of the report. The SHENZHEN TIMEWAY TESTING LABORATORIES. reserves the rights to withdraw it and to adopt any other remedies which may be appropriate.



6. 802.11b at 11Mbps of CH11



	Delta 1 [T1]	RBW	100 kHz	RF Att	20 dB
Ref Lvl	0.79 dB	VBW	300 kHz		
10 dBm	10.04008016 MHz	SWT	7.5 ms	Unit	dBm

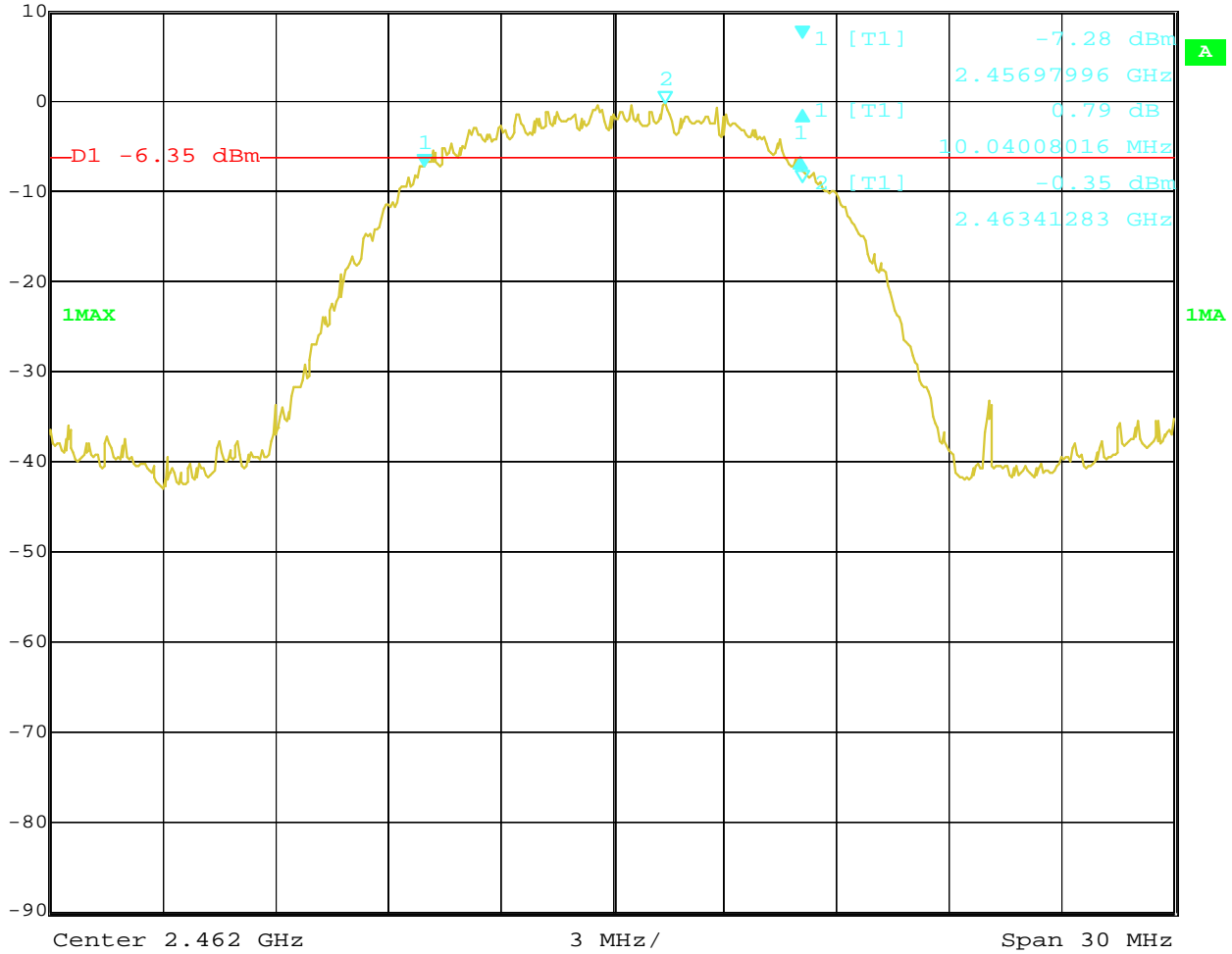

Date: 29.SEP.2021 11:15:20

The report refers only to the sample tested and does not apply to the bulk.  
 This report is issued in confidence to the client and it will be strictly treated as such by the SHENZHEN TIMEWAY TESTING LABORATORIES. It may not be reproduced rather in its entirety or in part and it may not be used for advertising. The client to whom the report is issued may, however, show or send it or a certified copy thereof prepared by the SHENZHEN TIMEWAY TESTING LABORATORIES to his customer. Supplier or others persons directly concerned. SHENZHEN TIMEWAY TESTING LABORATORIES will not, without the consent of the client enter into any discussion of correspondence with any third party concerning the contents of the report.  
 In the event of the improper use of the report. The SHENZHEN TIMEWAY TESTING LABORATORIES reserves the rights to withdraw it and to adopt any other remedies which may be appropriate.



**6dB Occupied Bandwidth**

EUT		Wireless Remote Control Outlet		Model		RSN011R	
Mode		802.11g		Input Voltage		120V~	
Temperature		24 deg. C,		Humidity		56% RH	
Channel	Channel Frequency (MHz)	Data Transfer Rate (Mbps)	6dB Bandwidth (MHz)	Minimum Limit (MHz)	Pass/ Fail		
1	2412	6	15.51	0.5	Pass		
6	2437	6	15.51	0.5	Pass		
11	2462	6	15.51	0.5	Pass		

The report refers only to the sample tested and does not apply to the bulk.  
 This report is issued in confidence to the client and it will be strictly treated as such by the SHENZHEN TIMEWAY TESTING LABORATORIES. It may not be reproduced rather in its entirety or in part and it may not be used for advertising. The client to whom the report is issued may, however, show or send it . or a certified copy there of prepared by the SHENZHEN TIMEWAY TESTING LABORATORIES. to his customer. Supplier or others persons directly concerned. SHENZHEN TIMEWAY TESTING LABORATORIES. will not, without the consent of the client enter into any discussion of correspondence with any third party concerning the contents of the report.  
 In the event of the improper use of the report. The SHENZHEN TIMEWAY TESTING LABORATORIES. reserves the rights to withdraw it and to adopt any other remedies which may be appropriate.





**Test Plots:**

**1. 802.11g at 6Mbps of CH01**

	Delta 1 [T1]	RBW	100 kHz	RF Att	20 dB
	Ref Lvl	-1.90 dB	VBW	300 kHz	
	10 dBm	15.51102204 MHz	SWT	7.5 ms	Unit dBm

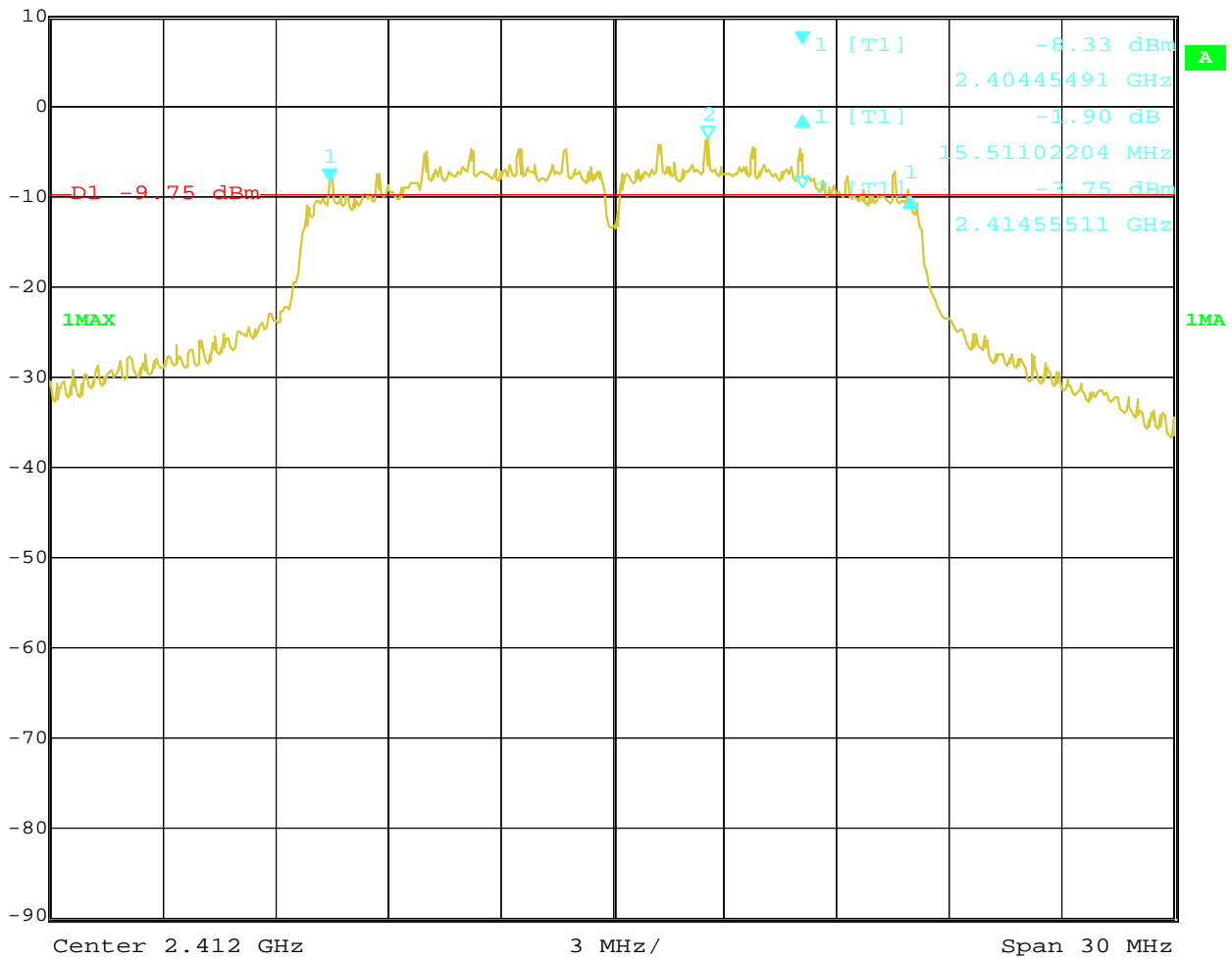

Date: 29.SEP.2021 11:03:38

The report refers only to the sample tested and does not apply to the bulk.  
 This report is issued in confidence to the client and it will be strictly treated as such by the SHENZHEN TIMEWAY TESTING LABORATORIES. It may not be reproduced rather in its entirety or in part and it may not be used for adverting. The client to whom the report is issued may, however, show or send it . or a certified copy there of prepared by the SHENZHEN TIMEWAY TESTING LABORATORIES. to his customer. Supplier or others persons directly concerned. SHENZHEN TIMEWAY TESTING LABORATORIES. will not, without the consent of the client enter into any discussion of correspondence with any third party concerning the contents of the report.  
 In the event of the improper use of the report. The SHENZHEN TIMEWAY TESTING LABORATORIES. reserves the rights to withdraw it and to adopt any other remedies which may be appropriate.



2. 802.11g at 6Mbps of CH06

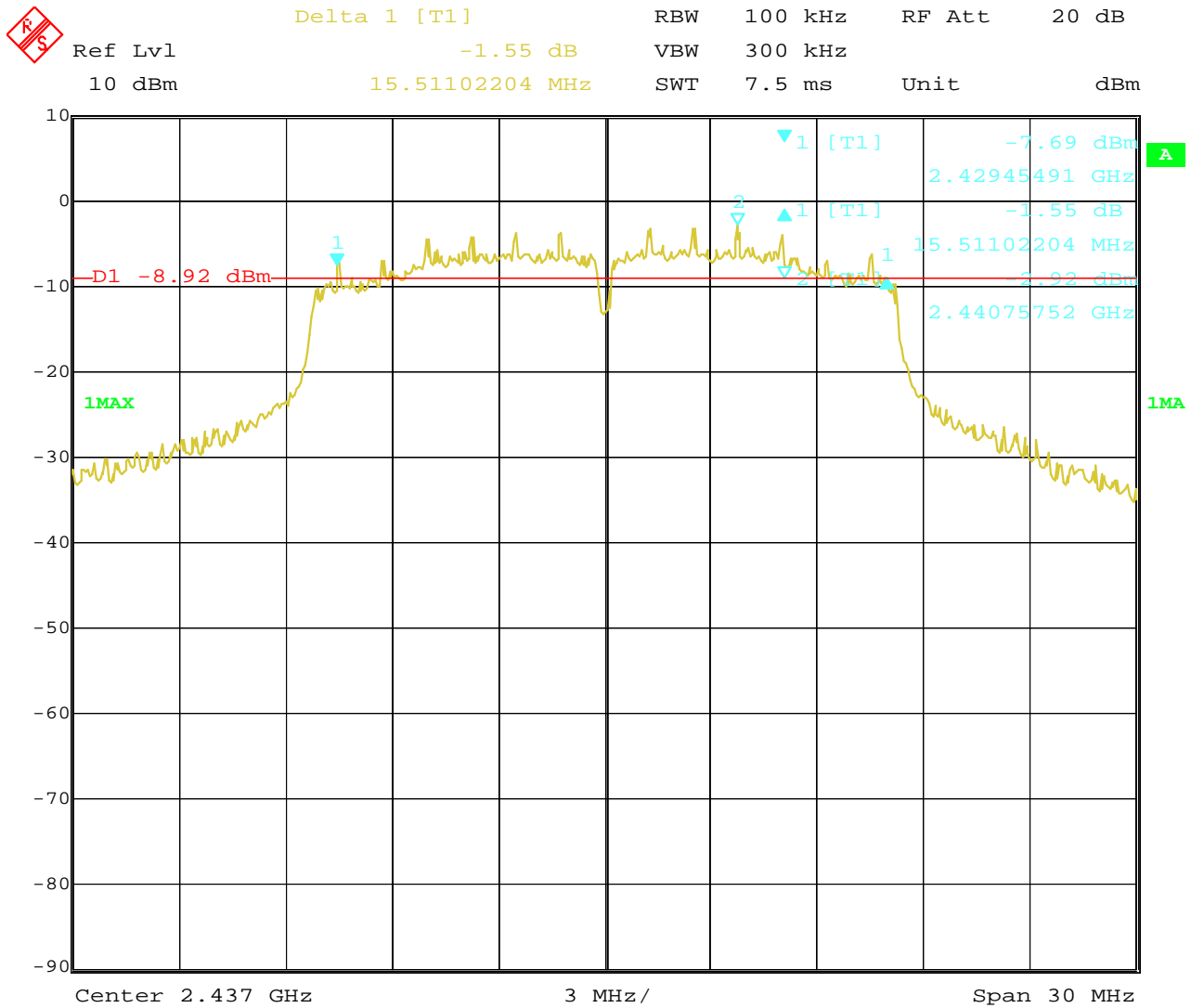

Date: 29.SEP.2021 10:52:51

The report refers only to the sample tested and does not apply to the bulk.  
 This report is issued in confidence to the client and it will be strictly treated as such by the SHENZHEN TIMEWAY TESTING LABORATORIES. It may not be reproduced rather in its entirety or in part and it may not be used for advertising. The client to whom the report is issued may, however, show or send it . or a certified copy there of prepared by the SHENZHEN TIMEWAY TESTING LABORATORIES. to his customer. Supplier or others persons directly concerned. SHENZHEN TIMEWAY TESTING LABORATORIES. will not, without the consent of the client enter into any discussion of correspondence with any third party concerning the contents of the report.  
 In the event of the improper use of the report. The SHENZHEN TIMEWAY TESTING LABORATORIES. reserves the rights to withdraw it and to adopt any other remedies which may be appropriate.



3. 802.11g at 6Mbps of CH11



Ref Lvl	Delta 1 [T1]	RBW	100 kHz	RF Att	20 dB
10 dBm	-1.45 dB	VBW	300 kHz		
	15.51102204 MHz	SWT	7.5 ms	Unit	dBm

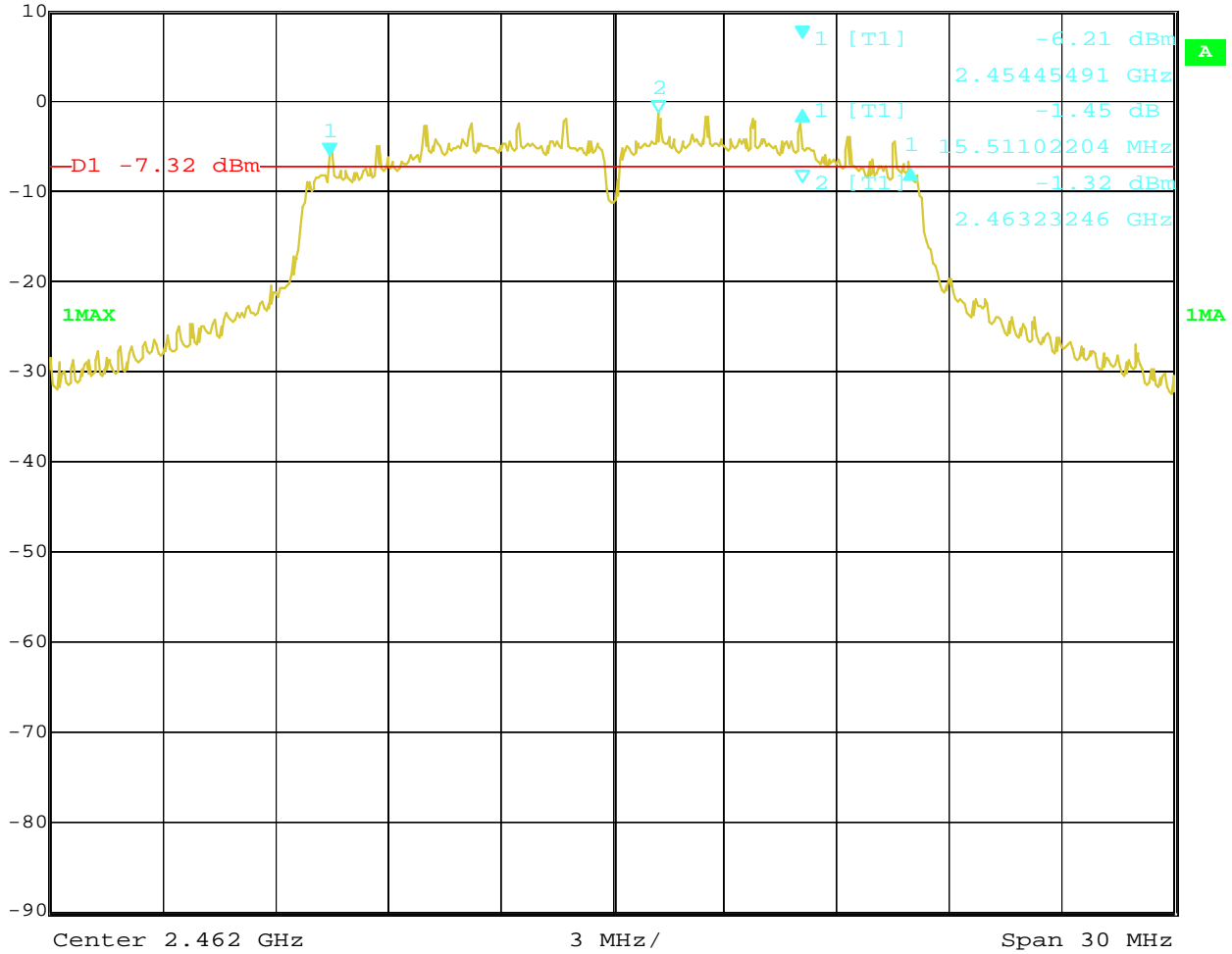

Date: 29.SEP.2021 10:45:23

The report refers only to the sample tested and does not apply to the bulk.  
 This report is issued in confidence to the client and it will be strictly treated as such by the SHENZHEN TIMEWAY TESTING LABORATORIES. It may not be reproduced rather in its entirety or in part and it may not be used for advertising. The client to whom the report is issued may, however, show or send it . or a certified copy there of prepared by the SHENZHEN TIMEWAY TESTING LABORATORIES. to his customer. Supplier or others persons directly concerned. SHENZHEN TIMEWAY TESTING LABORATORIES. will not, without the consent of the client enter into any discussion of correspondence with any third party concerning the contents of the report.  
 In the event of the improper use of the report. The SHENZHEN TIMEWAY TESTING LABORATORIES. reserves the rights to withdraw it and to adopt any other remedies which may be appropriate.



**6dB Occupied Bandwidth**

EUT		Wireless Remote Control Outlet		Model	RSN011R
Mode		802.11n HT20		Input Voltage	120V~
Temperature		24 deg. C,		Humidity	56% RH
Channel	Channel Frequency (MHz)	Data Transfer Rate (Mbps)	6 dB Bandwidth (MHz)	Minimum Limit (MHz)	Pass/ Fail
1	2412	mcs0	16.77	0.5	Pass
6	2437	mcs0	16.77	0.5	Pass
11	2462	mcs0	16.77	0.5	Pass

The report refers only to the sample tested and does not apply to the bulk.  
 This report is issued in confidence to the client and it will be strictly treated as such by the SHENZHEN TIMEWAY TESTING LABORATORIES. It may not be reproduced rather in its entirety or in part and it may not be used for advertizing. The client to whom the report is issued may, however, show or send it . or a certified copy there of prepared by the SHENZHEN TIMEWAY TESTING LABORATORIES. to his customer. Supplier or others persons directly concerned. SHENZHEN TIMEWAY TESTING LABORATORIES. will not, without the consent of the client enter into any discussion of correspondence with any third party concerning the contents of the report.  
 In the event of the improper use of the report. The SHENZHEN TIMEWAY TESTING LABORATORIES. reserves the rights to withdraw it and to adopt any other remedies which may be appropriate.



**Test Plots:**

**1. 802.11n at HT20 of CH01**

	Delta 1 [T1]	RBW	100 kHz	RF Att	20 dB
	Ref Lvl	0.03 dB	VBW	300 kHz	
	10 dBm	16.77354709 MHz	SWT	7.5 ms	Unit dBm

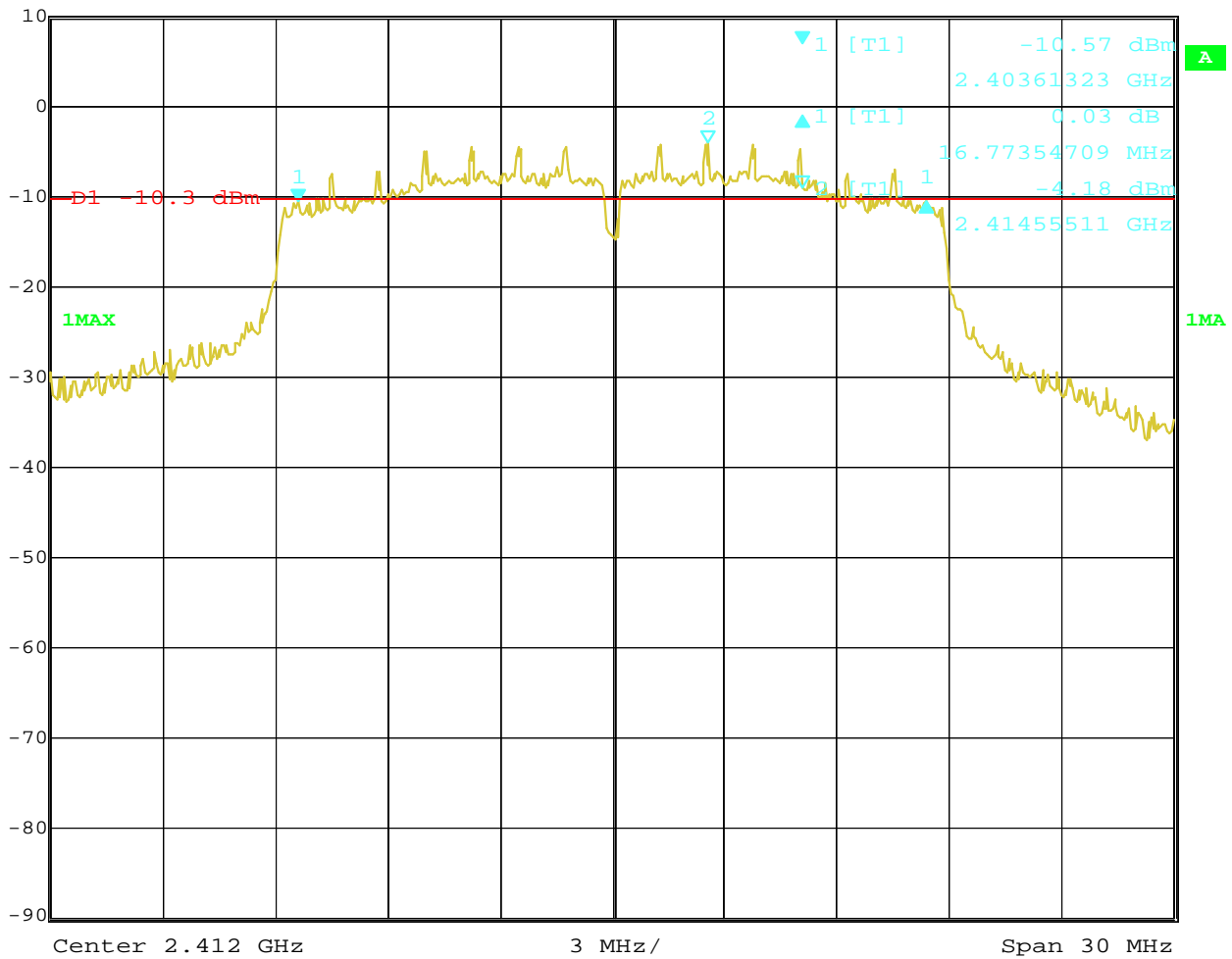

Date: 29.SEP.2021 13:18:06

The report refers only to the sample tested and does not apply to the bulk.  
 This report is issued in confidence to the client and it will be strictly treated as such by the SHENZHEN TIMEWAY TESTING LABORATORIES. It may not be reproduced rather in its entirety or in part and it may not be used for adverting. The client to whom the report is issued may, however, show or send it . or a certified copy there of prepared by the SHENZHEN TIMEWAY TESTING LABORATORIES. to his customer. Supplier or others persons directly concerned. SHENZHEN TIMEWAY TESTING LABORATORIES. will not, without the consent of the client enter into any discussion of correspondence with any third party concerning the contents of the report.  
 In the event of the improper use of the report. The SHENZHEN TIMEWAY TESTING LABORATORIES. reserves the rights to withdraw it and to adopt any other remedies which may be appropriate.



2. 802.11n at HT20 of CH06

	Delta 1 [T1]	RBW	100 kHz	RF Att	20 dB
	Ref Lvl	0.61 dB	VBW	300 kHz	
	10 dBm	16.77354709 MHz	SWT	7.5 ms	Unit dBm

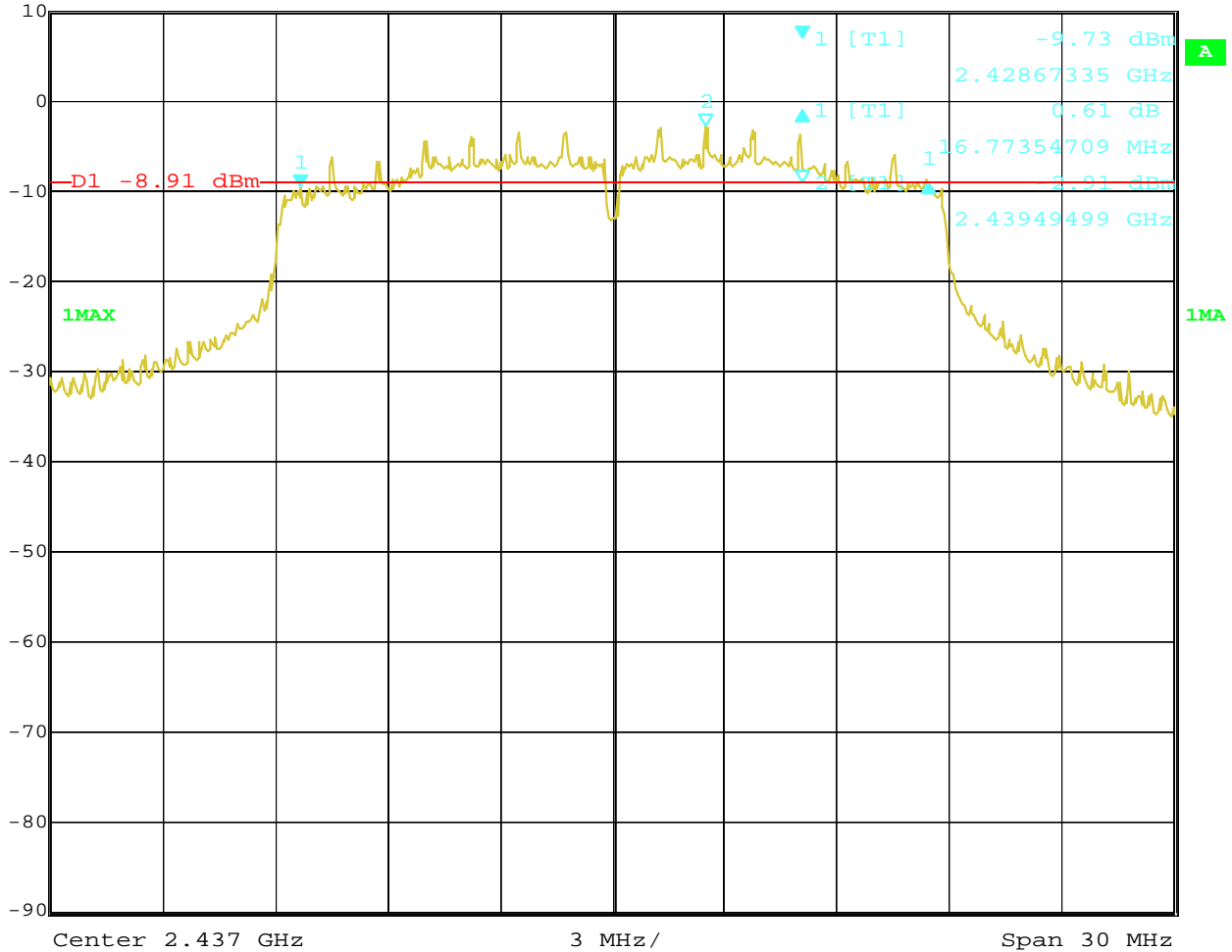

Date: 29.SEP.2021 13:23:34

The report refers only to the sample tested and does not apply to the bulk.  
 This report is issued in confidence to the client and it will be strictly treated as such by the SHENZHEN TIMEWAY TESTING LABORATORIES. It may not be reproduced rather in its entirety or in part and it may not be used for adverting. The client to whom the report is issued may, however, show or send it . or a certified copy there of prepared by the SHENZHEN TIMEWAY TESTING LABORATORIES. to his customer. Supplier or others persons directly concerned. SHENZHEN TIMEWAY TESTING LABORATORIES. will not, without the consent of the client enter into any discussion of correspondence with any third party concerning the contents of the report.  
 In the event of the improper use of the report. The SHENZHEN TIMEWAY TESTING LABORATORIES. reserves the rights to withdraw it and to adopt any other remedies which may be appropriate.



3. 802.11n at HT20 of CH11

	Delta 1 [T1]	RBW	100 kHz	RF Att	20 dB
	Ref Lvl	0.87 dB	VBW	300 kHz	
	10 dBm	16.77354709 MHz	SWT	7.5 ms	Unit dBm

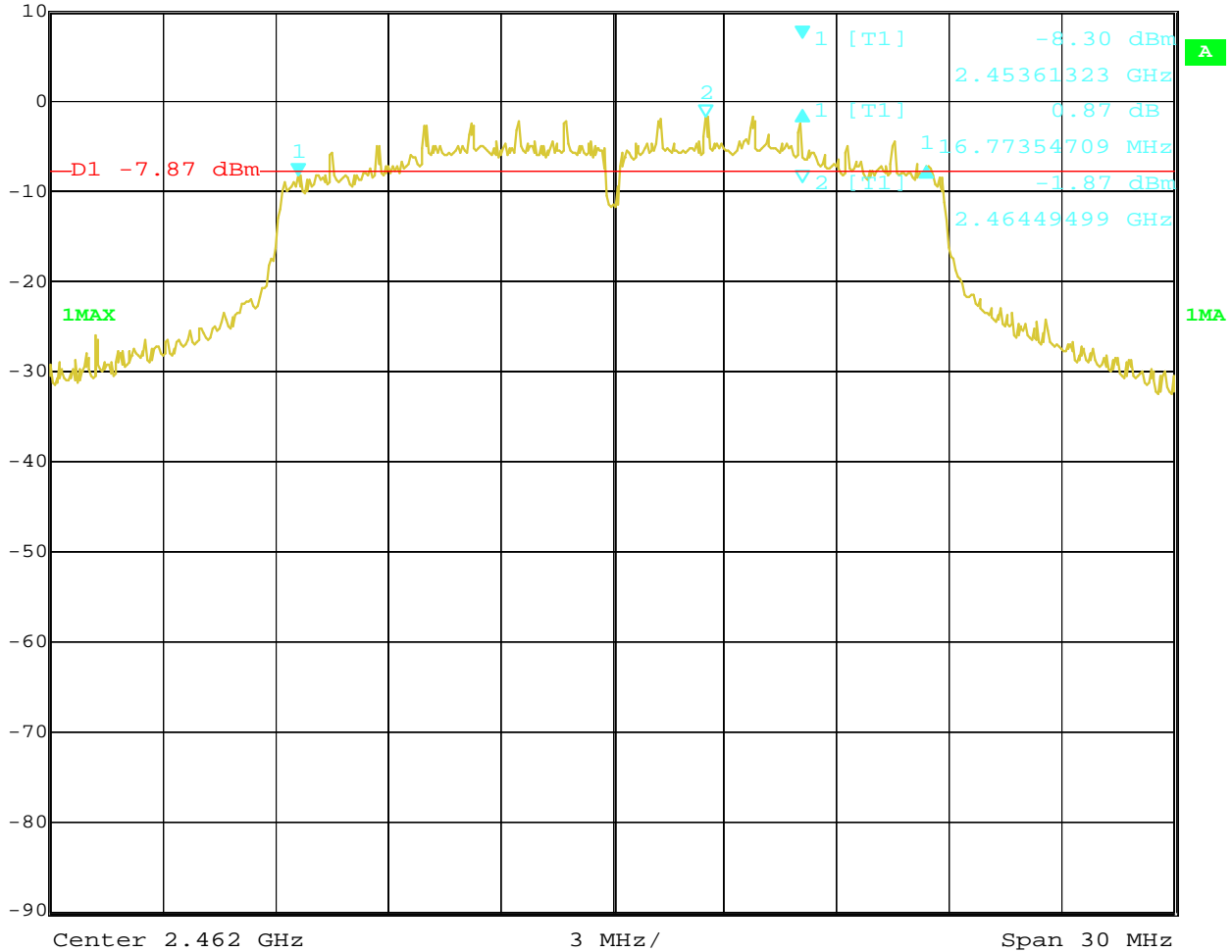

Date: 29.SEP.2021 13:31:06

The report refers only to the sample tested and does not apply to the bulk.  
 This report is issued in confidence to the client and it will be strictly treated as such by the SHENZHEN TIMEWAY TESTING LABORATORIES. It may not be reproduced rather in its entirety or in part and it may not be used for adverting. The client to whom the report is issued may, however, show or send it . or a certified copy there of prepared by the SHENZHEN TIMEWAY TESTING LABORATORIES. to his customer. Supplier or others persons directly concerned. SHENZHEN TIMEWAY TESTING LABORATORIES. will not, without the consent of the client enter into any discussion of correspondence with any third party concerning the contents of the report.  
 In the event of the improper use of the report. The SHENZHEN TIMEWAY TESTING LABORATORIES. reserves the rights to withdraw it and to adopt any other remedies which may be appropriate.



**6dB Occupied Bandwidth**

EUT		Wireless Remote Control Outlet		Model	RSN011R
Mode		802.11n HT40		Input Voltage	120V~
Temperature		24 deg. C,		Humidity	56% RH
Channel	Channel Frequency (MHz)	Data Transfer Rate (Mbps)	6 dB Bandwidth (MHz)	Minimum Limit (MHz)	Pass/ Fail
3	2422	mcs0	35.37	0.5	Pass
6	2437	mcs0	35.37	0.5	Pass
9	2452	mcs0	35.37	0.5	Pass

The report refers only to the sample tested and does not apply to the bulk.  
 This report is issued in confidence to the client and it will be strictly treated as such by the SHENZHEN TIMEWAY TESTING LABORATORIES. It may not be reproduced rather in its entirety or in part and it may not be used for advertising. The client to whom the report is issued may, however, show or send it or a certified copy thereof prepared by the SHENZHEN TIMEWAY TESTING LABORATORIES to his customer. Supplier or others persons directly concerned. SHENZHEN TIMEWAY TESTING LABORATORIES will not, without the consent of the client enter into any discussion of correspondence with any third party concerning the contents of the report.  
 In the event of the improper use of the report. The SHENZHEN TIMEWAY TESTING LABORATORIES reserves the rights to withdraw it and to adopt any other remedies which may be appropriate.





**Test Plots:**

**1. 802.11n at HT40 of CH03**

 Delta 1 [T1] RBW 100 kHz RF Att 20 dB  
 Ref Lvl -1.42 dB VBW 300 kHz  
 10 dBm 35.37074148 MHz SWT 12.5 ms Unit dBm

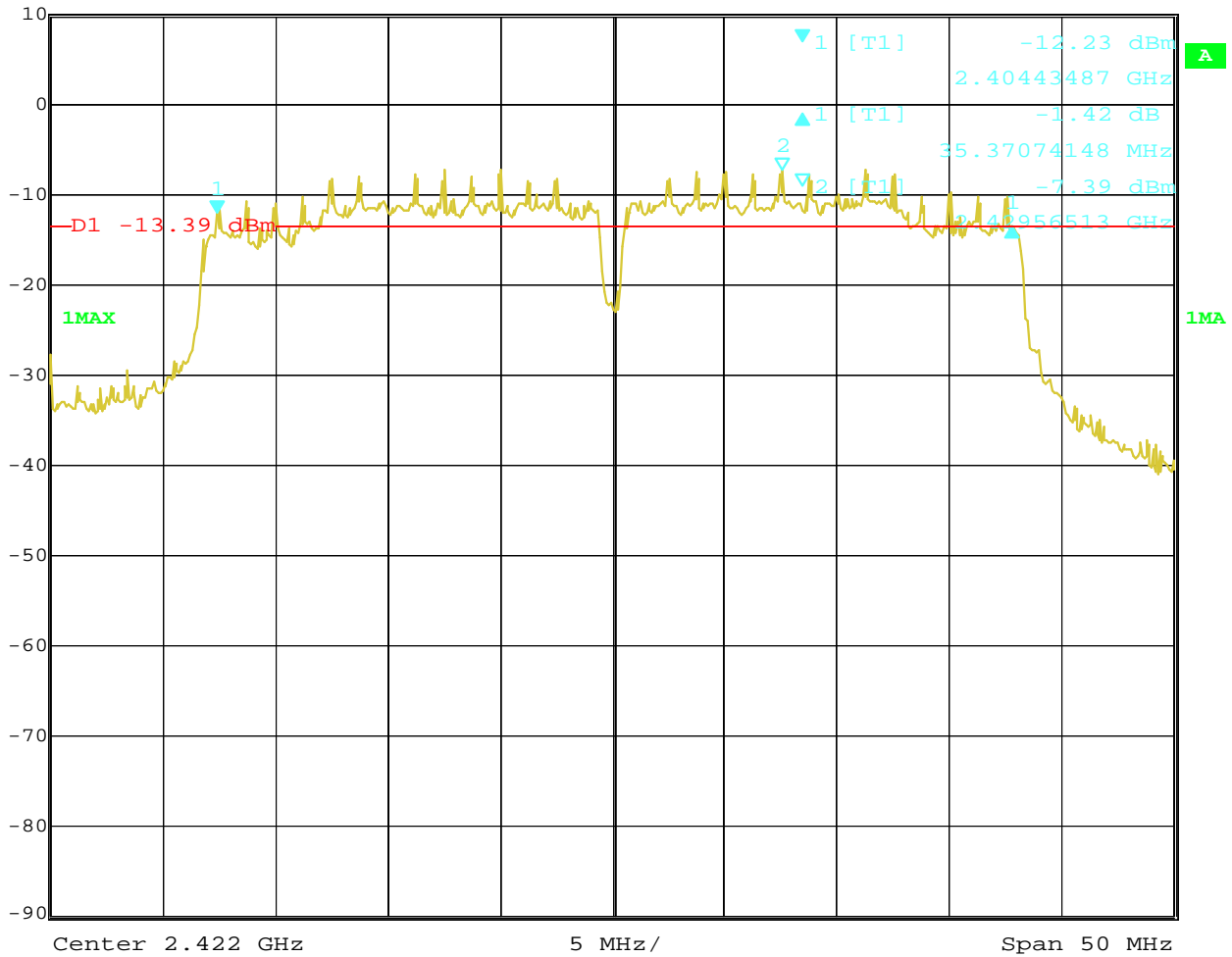

Date: 29.SEP.2021 13:44:17

The report refers only to the sample tested and does not apply to the bulk. This report is issued in confidence to the client and it will be strictly treated as such by the SHENZHEN TIMEWAY TESTING LABORATORIES. It may not be reproduced rather in its entirety or in part and it may not be used for advertising. The client to whom the report is issued may, however, show or send it . or a certified copy there of prepared by the SHENZHEN TIMEWAY TESTING LABORATORIES. to his customer. Supplier or others persons directly concerned. SHENZHEN TIMEWAY TESTING LABORATORIES. will not, without the consent of the client enter into any discussion of correspondence with any third party concerning the contents of the report. In the event of the improper use of the report. The SHENZHEN TIMEWAY TESTING LABORATORIES. reserves the rights to withdraw it and to adopt any other remedies which may be appropriate.



2. 802.11n at HT40 of CH06

	Delta 1 [T1]	RBW	100 kHz	RF Att	20 dB
	Ref Lvl	-0.92 dB	VBW	300 kHz	
	10 dBm	35.37074148 MHz	SWT	12.5 ms	Unit dBm

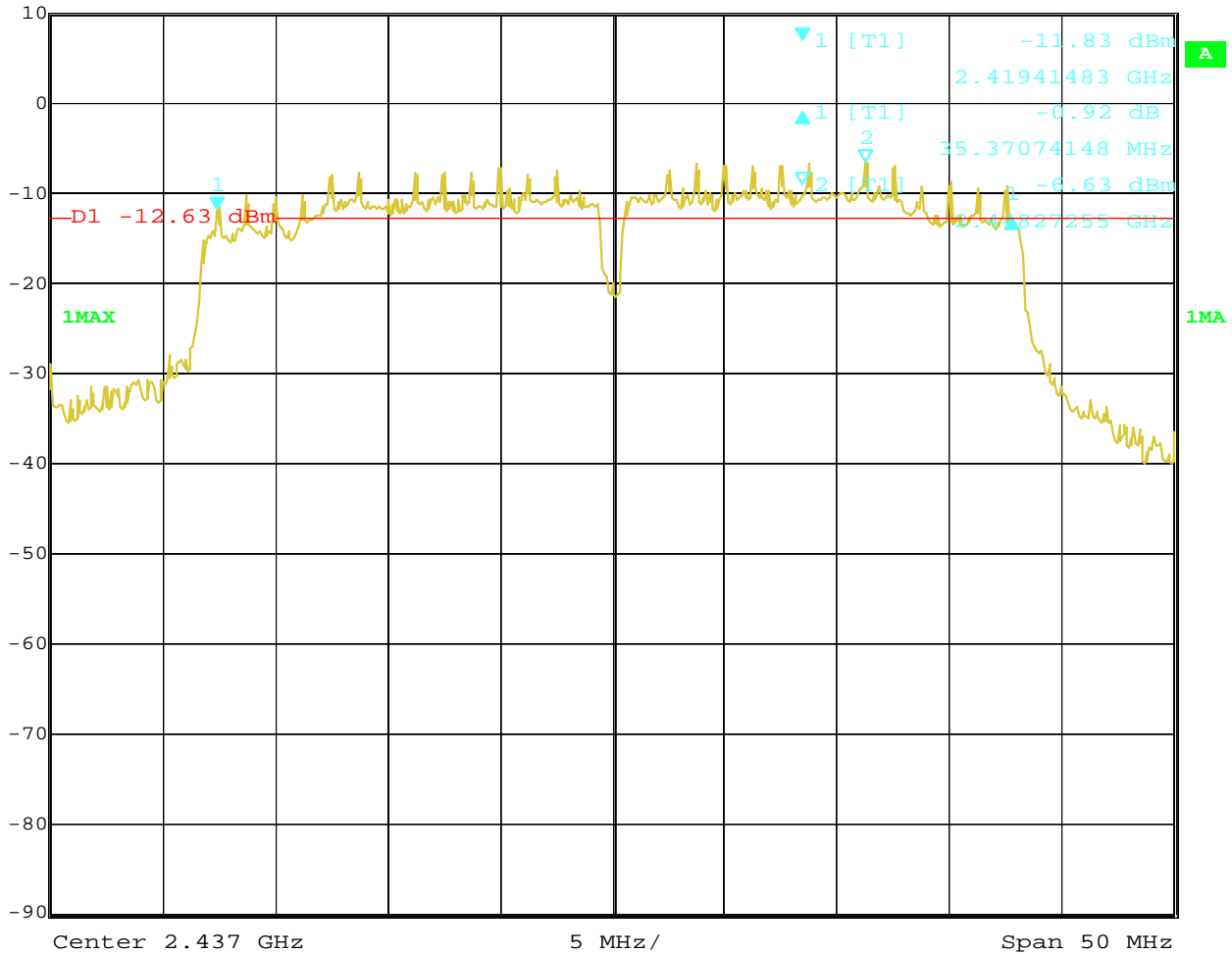

Date: 29.SEP.2021 13:49:27

The report refers only to the sample tested and does not apply to the bulk.  
 This report is issued in confidence to the client and it will be strictly treated as such by the SHENZHEN TIMEWAY TESTING LABORATORIES. It may not be reproduced rather in its entirety or in part and it may not be used for advertising. The client to whom the report is issued may, however, show or send it . or a certified copy there of prepared by the SHENZHEN TIMEWAY TESTING LABORATORIES. to his customer. Supplier or others persons directly concerned. SHENZHEN TIMEWAY TESTING LABORATORIES. will not, without the consent of the client enter into any discussion of correspondence with any third party concerning the contents of the report.  
 In the event of the improper use of the report. The SHENZHEN TIMEWAY TESTING LABORATORIES. reserves the rights to withdraw it and to adopt any other remedies which may be appropriate.



3. 802.11n at HT40 of CH09

	Delta 1 [T1]	RBW	100 kHz	RF Att	20 dB
	Ref Lvl	-0.56 dB	VBW	300 kHz	
	10 dBm	35.37074148 MHz	SWT	12.5 ms	Unit dBm

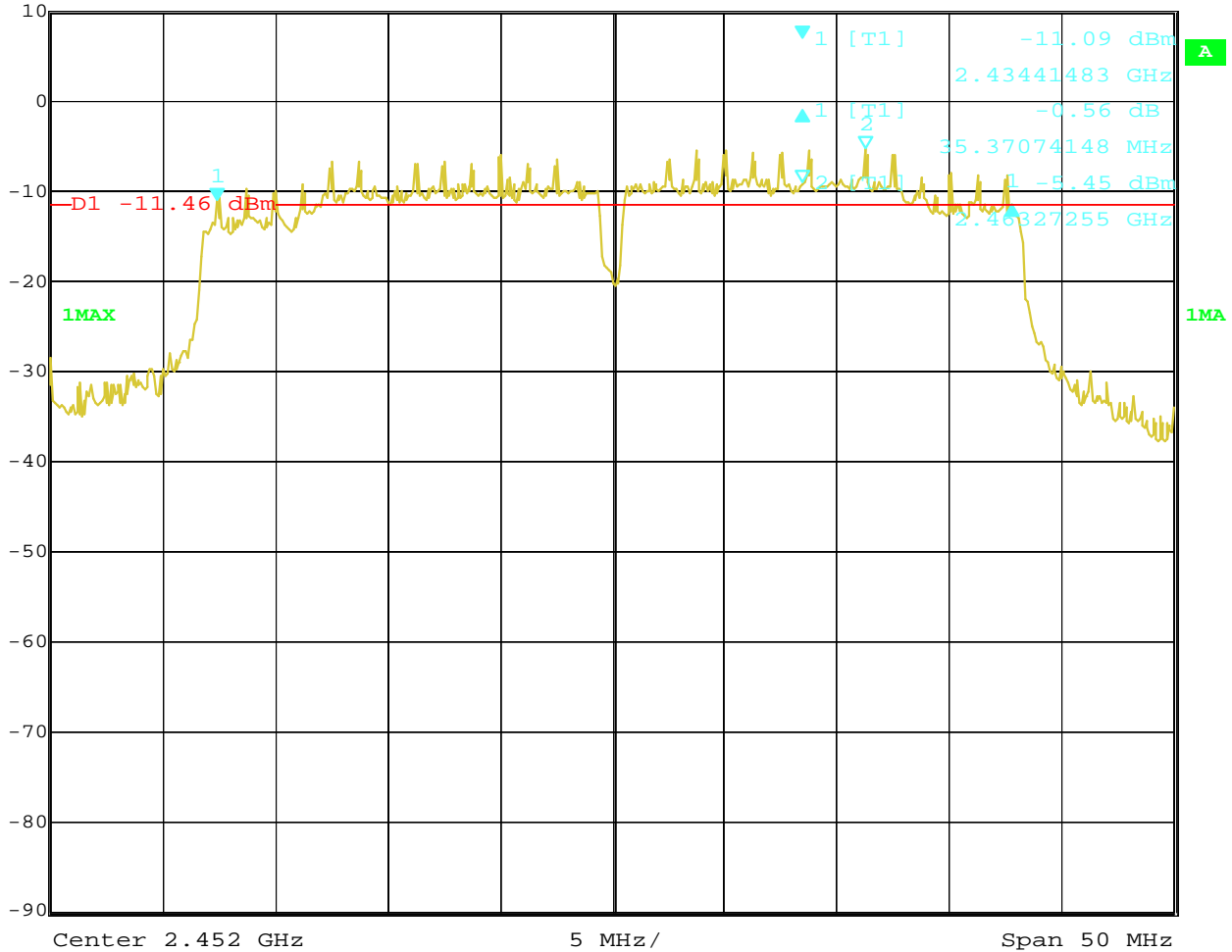

Date: 29.SEP.2021 13:57:47

The report refers only to the sample tested and does not apply to the bulk.  
 This report is issued in confidence to the client and it will be strictly treated as such by the SHENZHEN TIMEWAY TESTING LABORATORIES. It may not be reproduced rather in its entirety or in part and it may not be used for adverting. The client to whom the report is issued may, however, show or send it . or a certified copy there of prepared by the SHENZHEN TIMEWAY TESTING LABORATORIES. to his customer. Supplier or others persons directly concerned. SHENZHEN TIMEWAY TESTING LABORATORIES. will not, without the consent of the client enter into any discussion of correspondence with any third party concerning the contents of the report.  
 In the event of the improper use of the report. The SHENZHEN TIMEWAY TESTING LABORATORIES. reserves the rights to withdraw it and to adopt any other remedies which may be appropriate.



## 8. Maximum Output Power

### 8.1 Test Setup

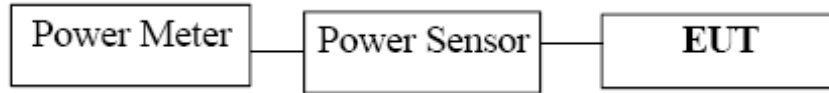

### 8.2 Limits of Maximum Output Power

The Maximum Output Power Measurement is 30dBm.

### 8.3 Test Procedure

The RF power output was measured with a Power meter connected to the RF Antenna connector ( conducted measurement ) while EUT was operating in transmit mode at the appropriate centre frequency.

**Note: the Peak power was measured**

The report refers only to the sample tested and does not apply to the bulk.

This report is issued in confidence to the client and it will be strictly treated as such by the SHENZHEN TIMEWAY TESTING LABORATORIES. It may not be reproduced rather in its entirety or in part and it may not be used for advertising. The client to whom the report is issued may, however, show or send it . or a certified copy there of prepared by the SHENZHEN TIMEWAY TESTING LABORATORIES. to his customer. Supplier or others persons directly concerned. SHENZHEN TIMEWAY TESTING LABORATORIES. will not, without the consent of the client enter into any discussion of correspondence with any third party concerning the contents of the report.

In the event of the improper use of the report. The SHENZHEN TIMEWAY TESTING LABORATORIES. reserves the rights to withdraw it and to adopt any other remedies which may be appropriate.



**8.4 Test Results**

EUT		Wireless Remote Control Outlet		Model		RSN011R	
Mode		802.11b		Input Voltage		120V~	
Temperature		24 deg. C,		Humidity		56% RH	
Channel	Frequency (MHz)	Max. Power Output (dBm)		Power Limit (dBm)	Pass/ Fail		
1	2412	12.99		30	Pass		
6	2437	13.57		30	Pass		
11	2462	14.76		30	Pass		

- Note: 1. At final test to get the worst-case emission at 1Mbps for CH01, CH06 and CH11  
 2. The result basic equation calculation as follow:  
 Power Output = Power Reading + Cable loss + Attenuator  
 3. The worse case was recorded

EUT		Wireless Remote Control Outlet		Model		RSN011R	
Mode		802.11g		Input Voltage		120V~	
Temperature		24 deg. C,		Humidity		56% RH	
Channel	Frequency (MHz)	Max. Power Output (dBm)		Power Limit (dBm)	Pass/ Fail		
1	2412	14.99		30	Pass		
6	2437	15.98		30	Pass		
11	2462	16.92		30	Pass		

- Note: 1. At final test to get the worst-case emission at 6Mbps for CH01, CH06 and CH11  
 2. The result basic equation calculation as follow:  
 Power Output = Power Reading + Cable loss + Attenuator  
 3. The worse case was recorded

The report refers only to the sample tested and does not apply to the bulk.  
 This report is issued in confidence to the client and it will be strictly treated as such by the SHENZHEN TIMEWAY TESTING LABORATORIES. It may not be reproduced rather in its entirety or in part and it may not be used for advertising. The client to whom the report is issued may, however, show or send it, or a certified copy thereof prepared by the SHENZHEN TIMEWAY TESTING LABORATORIES, to his customer. Supplier or others persons directly concerned. SHENZHEN TIMEWAY TESTING LABORATORIES, will not, without the consent of the client enter into any discussion of correspondence with any third party concerning the contents of the report.  
 In the event of the improper use of the report. The SHENZHEN TIMEWAY TESTING LABORATORIES, reserves the rights to withdraw it and to adopt any other remedies which may be appropriate.



EUT	Wireless Remote Control Outlet		Model	RSN011R	
Mode	802.11n (HT20)		Input Voltage	120V~	
Temperature	24 deg. C,		Humidity	56% RH	
Channel	Frequency (MHz)	Max. Power Output (dBm)		Power Limit (dBm)	Pass/ Fail
1	2412	13.65		30	Pass
6	2437	14.83		30	Pass
11	2462	16.18		30	Pass

- Note: 1. At final test to get the worst-case emission at mcs0 of 11n HT20 for CH01, CH06 and CH11  
 2. The result basic equation calculation as follow:  
 Power Output = Power Reading + Cable loss + Attenuator  
 3. The worse case was recorded

EUT	Wireless Remote Control Outlet		Model	RSN011R	
Mode	802.11n (HT40)		Input Voltage	120V~	
Temperature	24 deg. C,		Humidity	56% RH	
Channel	Frequency (MHz)	Max. Power Output (dBm)		Power Limit (dBm)	Pass/ Fail
3	2422	14.08		30	Pass
6	2437	14.66		30	Pass
9	2452	15.72		30	Pass

- Note: 1. At final test to get the worst-case emission at msc0 of 11n HT40 for CH03, CH06 and CH09  
 2. The result basic equation calculation as follow:  
 Power Output = Power Reading + Cable loss + Attenuator  
 3. The worse case was recorded

The report refers only to the sample tested and does not apply to the bulk.  
 This report is issued in confidence to the client and it will be strictly treated as such by the SHENZHEN TIMEWAY TESTING LABORATORIES. It may not be reproduced rather in its entirety or in part and it may not be used for adverting. The client to whom the report is issued may, however, show or send it . or a certified copy there of prepared by the SHENZHEN TIMEWAY TESTING LABORATORIES. to his customer. Supplier or others persons directly concerned. SHENZHEN TIMEWAY TESTING LABORATORIES. will not, without the consent of the client enter into any discussion of correspondence with any third party concerning the contents of the report.  
 In the event of the improper use of the report. The SHENZHEN TIMEWAY TESTING LABORATORIES. reserves the rights to withdraw it and to adopt any other remedies which may be appropriate.



## 9. Power Spectral Density Measurement

### 9.1 Test Setup

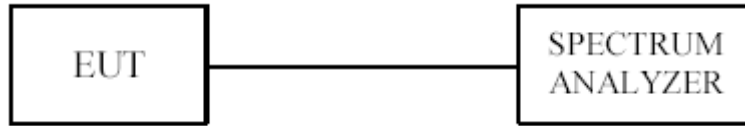

### 9.2 Limits of Power Spectral Density Measurement

The Maximum Power Spectral Density Measurement is 8dBm/3kHz.

### 9.3 Test Procedure

1. Use this procedure when the maximum peak conducted output power in the fundamental emission is used to demonstrate compliance.
2. Set the RBW = 10 kHz.
3. Set the VBW  $\geq$  30 kHz.
4. Set the span to 1.5 times the DTS channel bandwidth.
5. Detector = peak.
6. Sweep time = auto couple.
7. Trace mode = max hold.
8. Allow trace to fully stabilize.
9. Use the peak marker function to determine the maximum amplitude level.
10. If measured value exceeds limit, reduce RBW (no less than 3 kHz) and repeat.
11. The resulting peak PSD level must be  $\leq$  8 dBm/3kHz.

The report refers only to the sample tested and does not apply to the bulk.

This report is issued in confidence to the client and it will be strictly treated as such by the SHENZHEN TIMEWAY TESTING LABORATORIES. It may not be reproduced rather in its entirety or in part and it may not be used for advertising. The client to whom the report is issued may, however, show or send it, or a certified copy thereof prepared by the SHENZHEN TIMEWAY TESTING LABORATORIES, to his customer. Supplier or others persons directly concerned. SHENZHEN TIMEWAY TESTING LABORATORIES, will not, without the consent of the client enter into any discussion of correspondence with any third party concerning the contents of the report.

In the event of the improper use of the report. The SHENZHEN TIMEWAY TESTING LABORATORIES, reserves the rights to withdraw it and to adopt any other remedies which may be appropriate.



**9.4 Test Result**

EUT	Wireless Remote Control Outlet		Model	RSN011R	
Mode	802.11b 11Mbps		Test Voltage	120V~	
Temperature	24 deg. C,		Humidity	56% RH	
Channel	Frequency (MHz)	Power Spectral Density (dBm/10kHz)		Limit (dBm/3kHz)	Pass/ Fail
1	2412	-11.45		8	Pass
6	2437	-10.22		8	Pass
11	2462	-9.78		8	Pass

EUT	Wireless Remote Control Outlet		Model	RSN011R	
Mode	802.11b 1Mbps		Test Voltage	120V~	
Temperature	24 deg. C,		Humidity	56% RH	
Channel	Frequency (MHz)	Power Spectral Density (dBm/10kHz)		Limit (dBm/3kHz)	Pass/ Fail
1	2412	-11.19		8	Pass
6	2437	-9.75		8	Pass
11	2462	-9.03		8	Pass

EUT	Wireless Remote Control Outlet		Model	RSN011R	
Mode	802.11g 6Mbps		Test Voltage	120V~	
Temperature	24 deg. C,		Humidity	56% RH	
Channel	Frequency (MHz)	Power Spectral Density (dBm/10kHz)		Limit (dBm/3kHz)	Pass/ Fail
1	2412	-11.83		8	Pass
6	2437	-11.47		8	Pass
11	2462	-11.74		8	Pass

The report refers only to the sample tested and does not apply to the bulk.  
 This report is issued in confidence to the client and it will be strictly treated as such by the SHENZHEN TIMEWAY TESTING LABORATORIES. It may not be reproduced rather in its entirety or in part and it may not be used for advertising. The client to whom the report is issued may, however, show or send it . or a certified copy there of prepared by the SHENZHEN TIMEWAY TESTING LABORATORIES. to his customer. Supplier or others persons directly concerned. SHENZHEN TIMEWAY TESTING LABORATORIES. will not, without the consent of the client enter into any discussion of correspondence with any third party concerning the contents of the report.  
 In the event of the improper use of the report. The SHENZHEN TIMEWAY TESTING LABORATORIES. reserves the rights to withdraw it and to adopt any other remedies which may be appropriate.





EUT	Wireless Remote Control Outlet	Model	RSN011R	
Mode	802.11n HT20 mcs0	Test Voltage	120V~	
Temperature	24 deg. C,	Humidity	56% RH	
Channel	Frequency (MHz)	Power Spectral Density (dBm/10kHz)	Limit (dBm/3kHz)	Pass/ Fail
1	2412	-12.49	8	Pass
6	2437	-11.48	8	Pass
11	2462	-10.88	8	Pass

EUT	Wireless Remote Control Outlet	Model	RSN011R	
Mode	802.11n HT40 mcs0	Test Voltage	120V~	
Temperature	24 deg. C,	Humidity	56% RH	
Channel	Frequency (MHz)	Power Spectral Density (dBm/10kHz)	Limit (dBm/3kHz)	Pass/ Fail
3	2422	-15.57	8	Pass
6	2437	-15.09	8	Pass
9	2452	-15.08	8	Pass

The report refers only to the sample tested and does not apply to the bulk.  
 This report is issued in confidence to the client and it will be strictly treated as such by the SHENZHEN TIMEWAY TESTING LABORATORIES. It may not be reproduced rather in its entirety or in part and it may not be used for advertising. The client to whom the report is issued may, however, show or send it . or a certified copy there of prepared by the SHENZHEN TIMEWAY TESTING LABORATORIES. to his customer. Supplier or others persons directly concerned. SHENZHEN TIMEWAY TESTING LABORATORIES. will not, without the consent of the client enter into any discussion of correspondence with any third party concerning the contents of the report.  
 In the event of the improper use of the report. The SHENZHEN TIMEWAY TESTING LABORATORIES. reserves the rights to withdraw it and to adopt any other remedies which may be appropriate.



### 9.5 Photo of Power Spectral Density Measurement

1.802.11b at 11Mbps of CH01

	Marker 1 [T1]	RBW	10 kHz	RF Att	20 dB
	Ref Lvl	-11.45 dBm	VBW	30 kHz	
	10 dBm	2.41222635 GHz	SWT	380 ms	Unit dBm

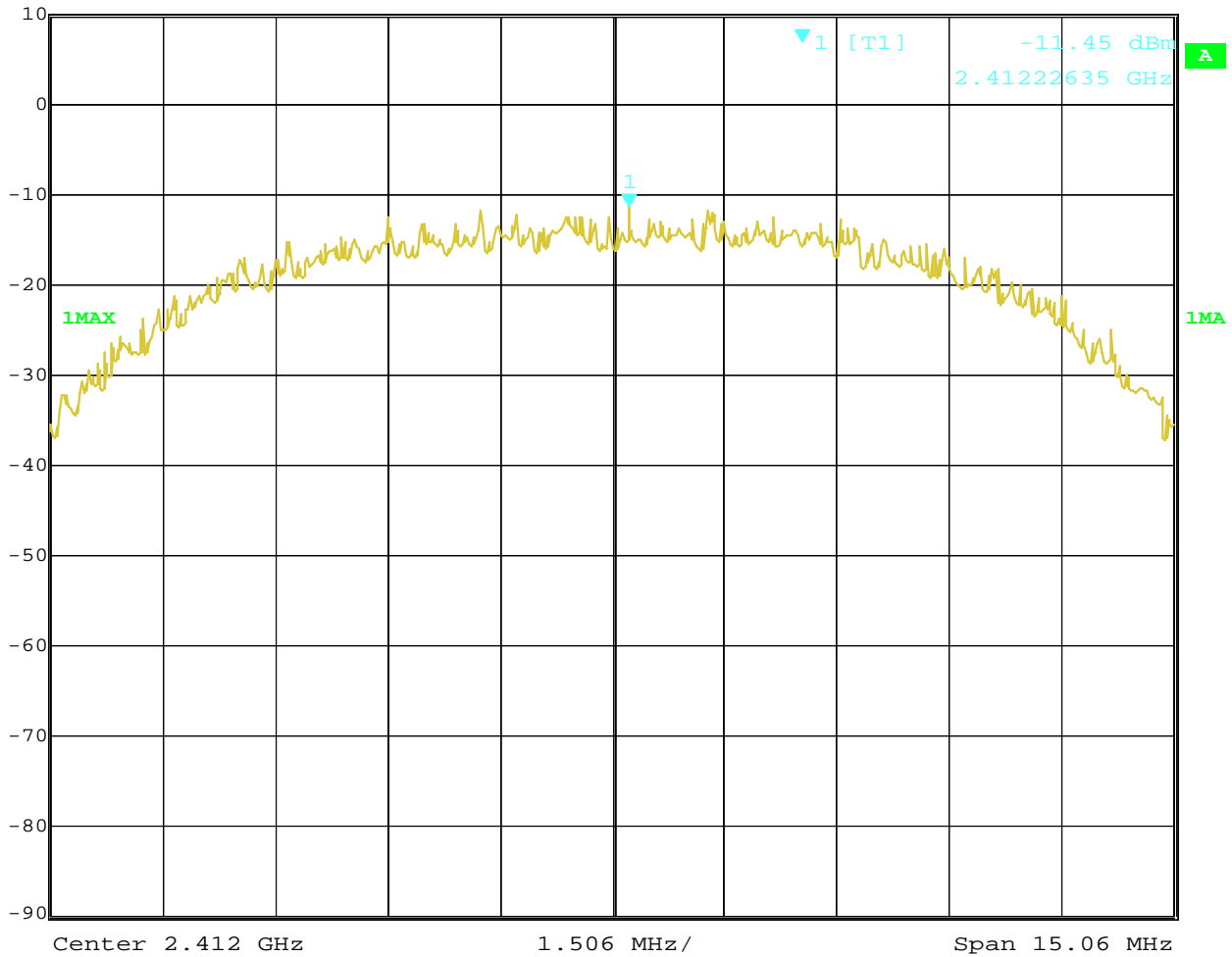

Date: 29.SEP.2021 14:34:25

The report refers only to the sample tested and does not apply to the bulk.  
 This report is issued in confidence to the client and it will be strictly treated as such by the SHENZHEN TIMEWAY TESTING LABORATORIES. It may not be reproduced rather in its entirety or in part and it may not be used for advertising. The client to whom the report is issued may, however, show or send it or a certified copy thereof prepared by the SHENZHEN TIMEWAY TESTING LABORATORIES to his customer. Supplier or others persons directly concerned. SHENZHEN TIMEWAY TESTING LABORATORIES will not, without the consent of the client enter into any discussion of correspondence with any third party concerning the contents of the report.  
 In the event of the improper use of the report. The SHENZHEN TIMEWAY TESTING LABORATORIES reserves the rights to withdraw it and to adopt any other remedies which may be appropriate.



2. 802.11b at 11Mbps at CH06

	Marker 1 [T1]	RBW	10 kHz	RF Att	20 dB
	Ref Lvl	-10.22 dBm	VBW	30 kHz	
	10 dBm	2.43722635 GHz	SWT	380 ms	Unit dBm

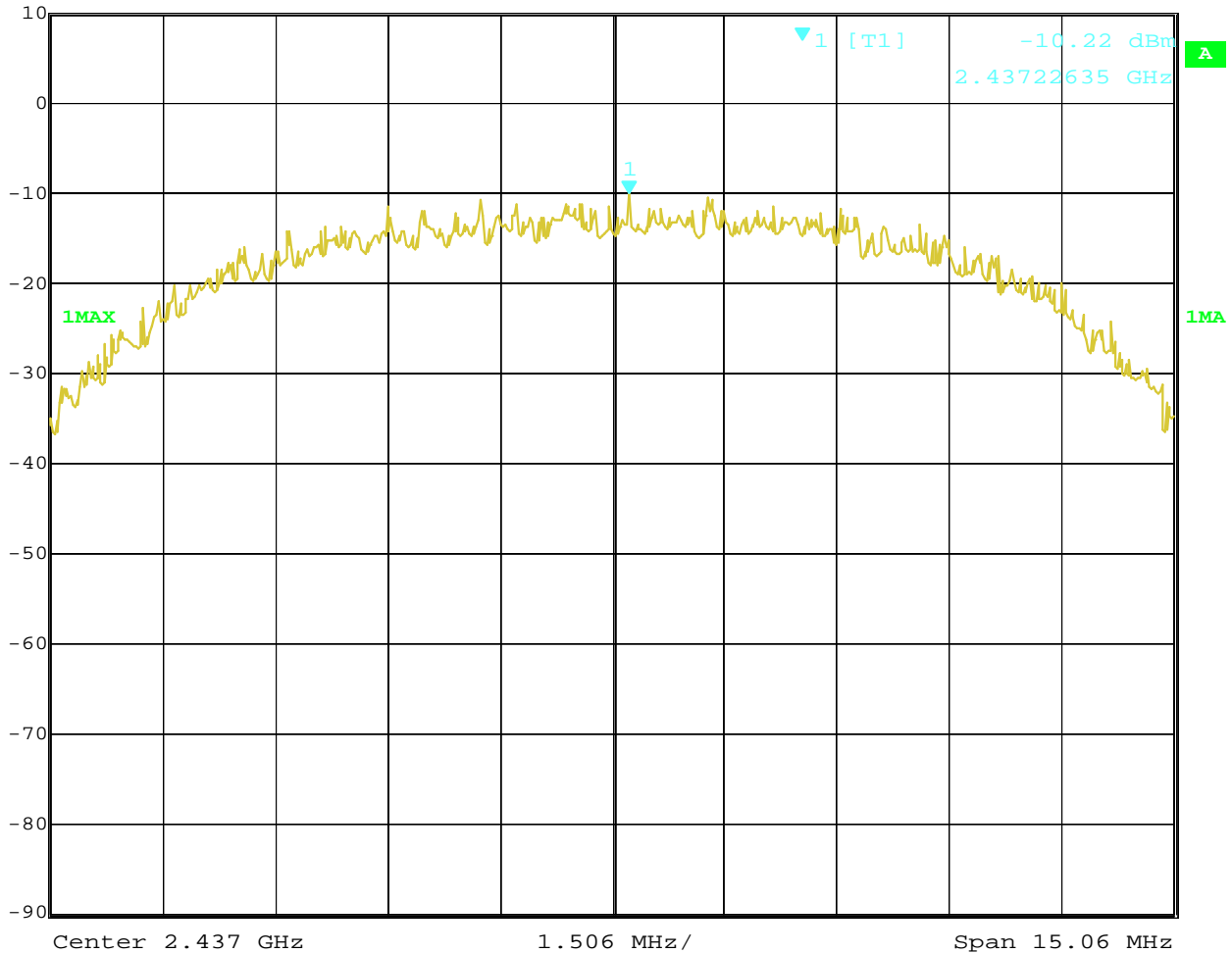

Date: 29.SEP.2021 14:35:30

The report refers only to the sample tested and does not apply to the bulk.  
 This report is issued in confidence to the client and it will be strictly treated as such by the SHENZHEN TIMEWAY TESTING LABORATORIES. It may not be reproduced rather in its entirety or in part and it may not be used for advertising. The client to whom the report is issued may, however, show or send it . or a certified copy there of prepared by the SHENZHEN TIMEWAY TESTING LABORATORIES. to his customer. Supplier or others persons directly concerned. SHENZHEN TIMEWAY TESTING LABORATORIES. will not, without the consent of the client enter into any discussion of correspondence with any third party concerning the contents of the report.  
 In the event of the improper use of the report. The SHENZHEN TIMEWAY TESTING LABORATORIES. reserves the rights to withdraw it and to adopt any other remedies which may be appropriate.



3. 802.11b at 11Mbps of CH11

	Marker 1 [T1]	RBW	10 kHz	RF Att	20 dB
	Ref Lvl	-9.78 dBm	VBW	30 kHz	
	10 dBm	2.46222635 GHz	SWT	380 ms	Unit dBm

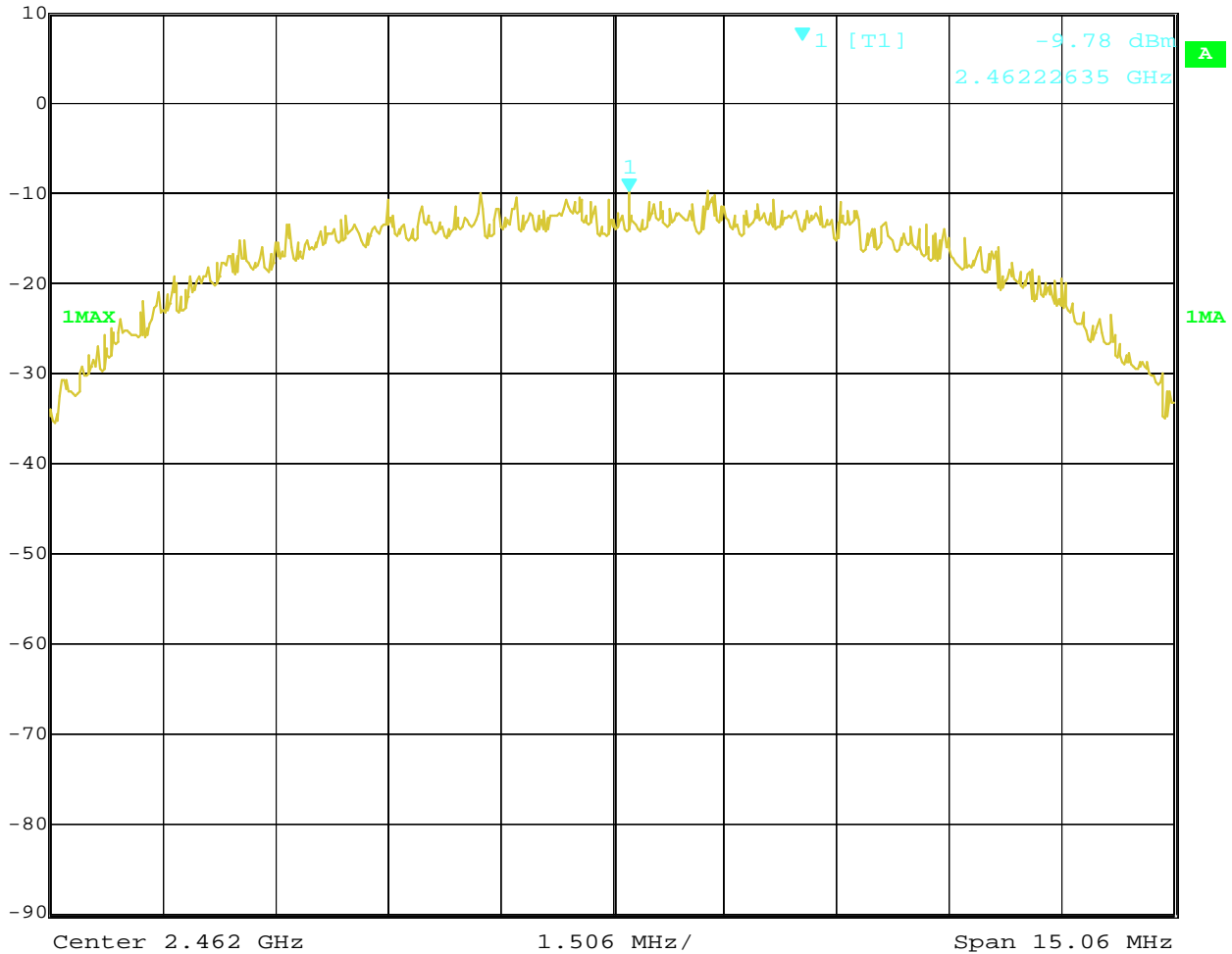

Date: 29.SEP.2021 14:36:51

The report refers only to the sample tested and does not apply to the bulk.  
 This report is issued in confidence to the client and it will be strictly treated as such by the SHENZHEN TIMEWAY TESTING LABORATORIES. It may not be reproduced rather in its entirety or in part and it may not be used for advertising. The client to whom the report is issued may, however, show or send it . or a certified copy there of prepared by the SHENZHEN TIMEWAY TESTING LABORATORIES. to his customer. Supplier or others persons directly concerned. SHENZHEN TIMEWAY TESTING LABORATORIES. will not, without the consent of the client enter into any discussion of correspondence with any third party concerning the contents of the report.  
 In the event of the improper use of the report. The SHENZHEN TIMEWAY TESTING LABORATORIES. reserves the rights to withdraw it and to adopt any other remedies which may be appropriate.



4. 802.11b at 1Mbps of CH1

	Marker 1 [T1]	RBW	10 kHz	RF Att	20 dB
	Ref Lvl	-11.19 dBm	VBW	30 kHz	
	10 dBm	2.41261870 GHz	SWT	380 ms	Unit dBm

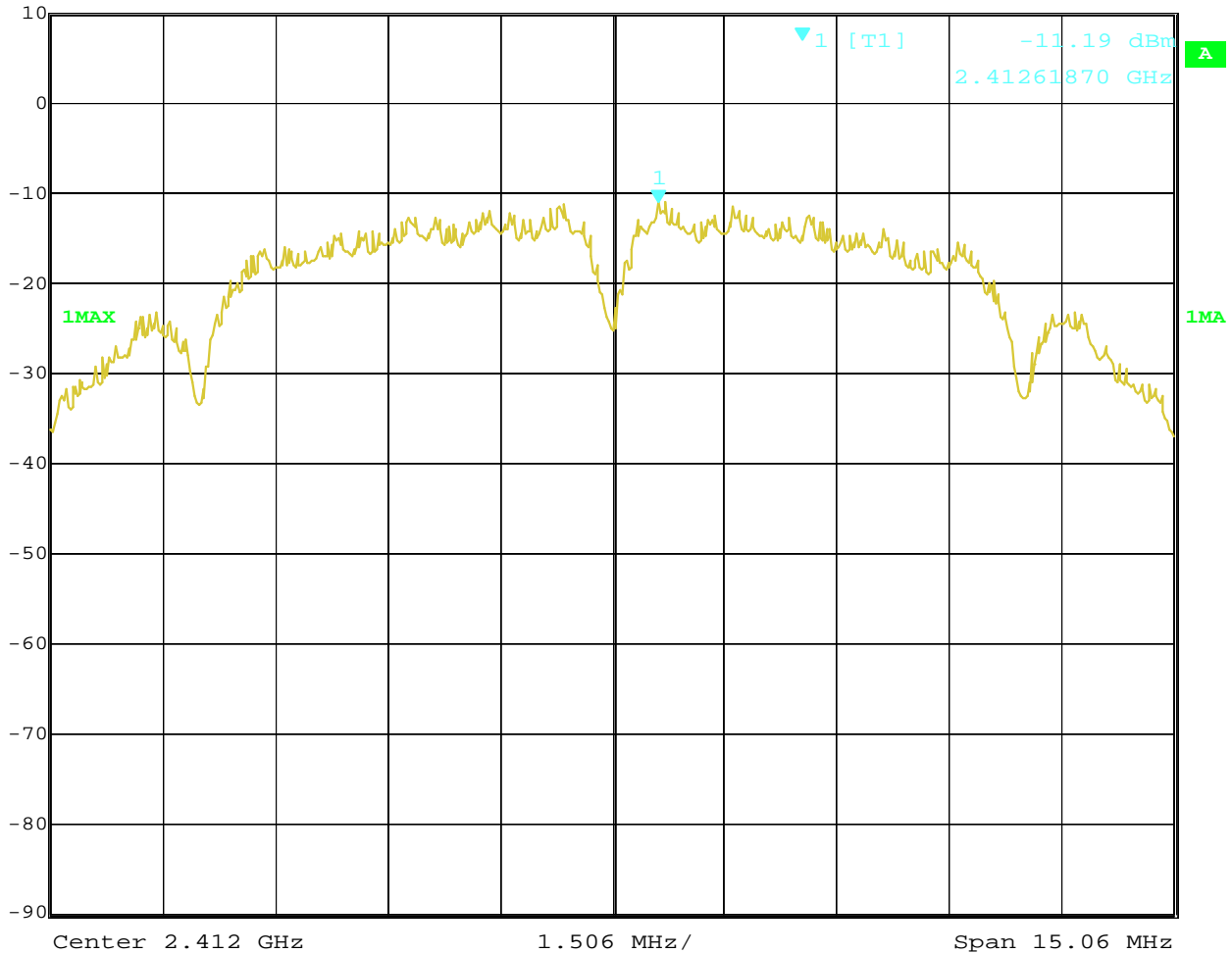

Date: 29.SEP.2021 14:42:42

The report refers only to the sample tested and does not apply to the bulk.  
 This report is issued in confidence to the client and it will be strictly treated as such by the SHENZHEN TIMEWAY TESTING LABORATORIES. It may not be reproduced rather in its entirety or in part and it may not be used for advertising. The client to whom the report is issued may, however, show or send it . or a certified copy there of prepared by the SHENZHEN TIMEWAY TESTING LABORATORIES. to his customer. Supplier or others persons directly concerned. SHENZHEN TIMEWAY TESTING LABORATORIES. will not, without the consent of the client enter into any discussion of correspondence with any third party concerning the contents of the report.  
 In the event of the improper use of the report. The SHENZHEN TIMEWAY TESTING LABORATORIES. reserves the rights to withdraw it and to adopt any other remedies which may be appropriate.



5. 802.11b at 1Mbps of CH6

	Marker 1 [T1]	RBW	10 kHz	RF Att	20 dB
	Ref Lvl	-9.75 dBm	VBW	30 kHz	
	10 dBm	2.43761870 GHz	SWT	380 ms	Unit dBm

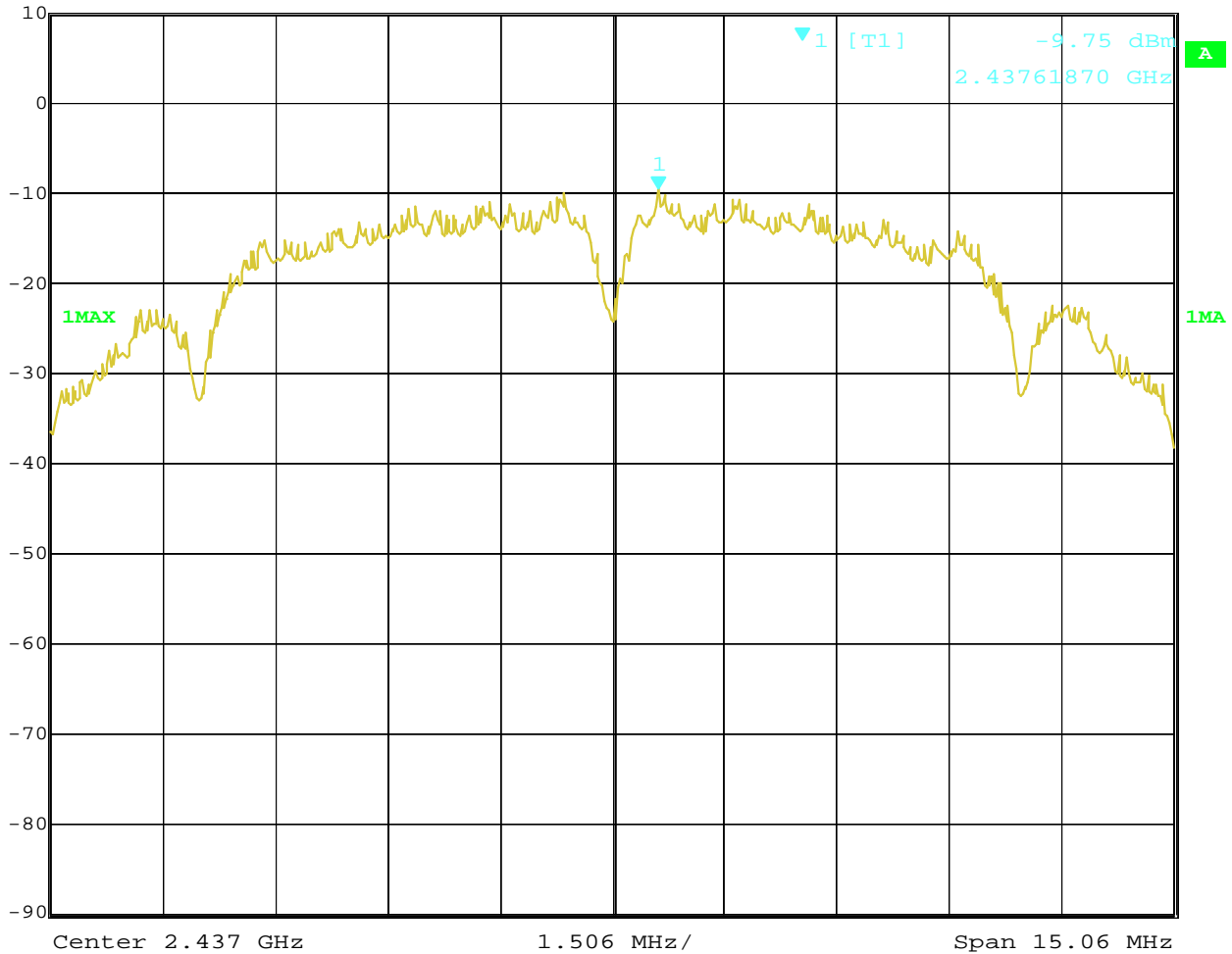

Date: 29.SEP.2021 14:40:31

The report refers only to the sample tested and does not apply to the bulk.  
 This report is issued in confidence to the client and it will be strictly treated as such by the SHENZHEN TIMEWAY TESTING LABORATORIES. It may not be reproduced rather in its entirety or in part and it may not be used for advertising. The client to whom the report is issued may, however, show or send it . or a certified copy there of prepared by the SHENZHEN TIMEWAY TESTING LABORATORIES. to his customer. Supplier or others persons directly concerned. SHENZHEN TIMEWAY TESTING LABORATORIES. will not, without the consent of the client enter into any discussion of correspondence with any third party concerning the contents of the report.  
 In the event of the improper use of the report. The SHENZHEN TIMEWAY TESTING LABORATORIES. reserves the rights to withdraw it and to adopt any other remedies which may be appropriate.



6. 802.11b at 1Mbps of CH11

	Marker 1 [T1]	RBW	10 kHz	RF Att	20 dB
	Ref Lvl	-9.03 dBm	VBW	30 kHz	
	10 dBm	2.46261870 GHz	SWT	380 ms	Unit dBm

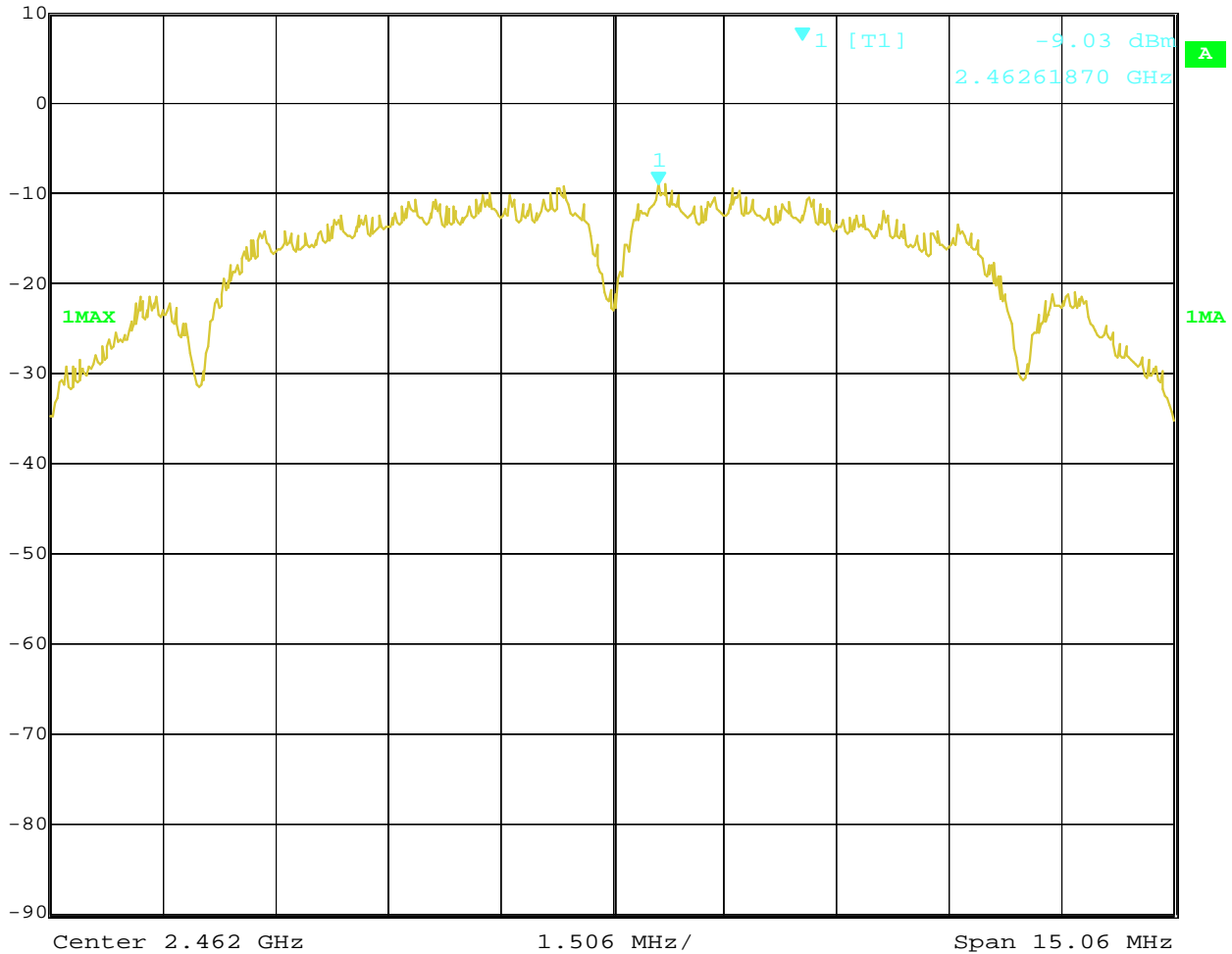

Date: 29.SEP.2021 14:39:33

The report refers only to the sample tested and does not apply to the bulk.  
 This report is issued in confidence to the client and it will be strictly treated as such by the SHENZHEN TIMEWAY TESTING LABORATORIES. It may not be reproduced rather in its entirety or in part and it may not be used for advertising. The client to whom the report is issued may, however, show or send it . or a certified copy there of prepared by the SHENZHEN TIMEWAY TESTING LABORATORIES. to his customer. Supplier or others persons directly concerned. SHENZHEN TIMEWAY TESTING LABORATORIES. will not, without the consent of the client enter into any discussion of correspondence with any third party concerning the contents of the report.  
 In the event of the improper use of the report. The SHENZHEN TIMEWAY TESTING LABORATORIES. reserves the rights to withdraw it and to adopt any other remedies which may be appropriate.



7. 802.11g at 6Mbps of CH1

	Marker 1 [T1]	RBW	10 kHz	RF Att	20 dB
	Ref Lvl	-11.83 dBm	VBW	30 kHz	
	10 dBm	2.41323578 GHz	SWT	600 ms	Unit dBm

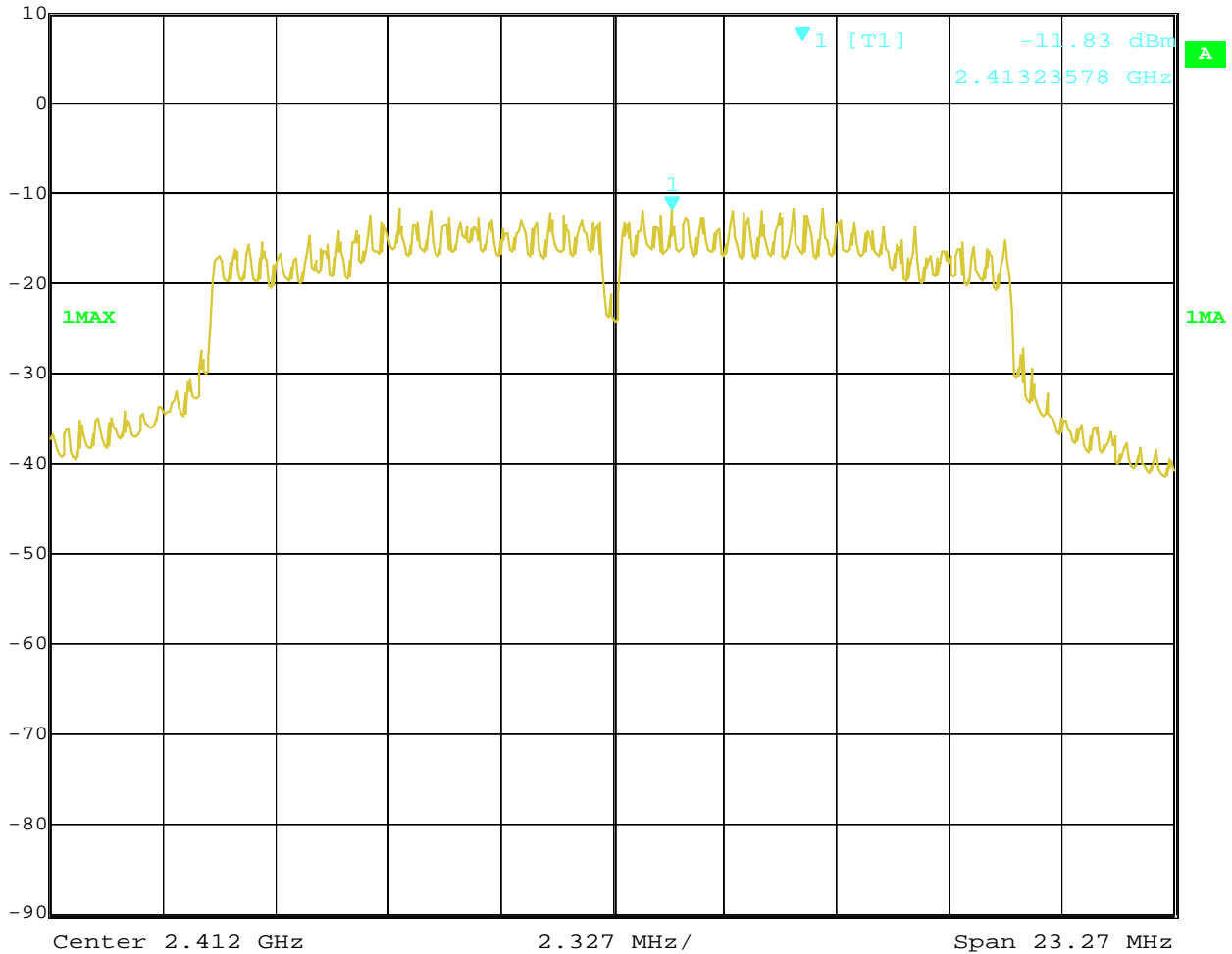

Date: 29.SEP.2021 14:31:09

The report refers only to the sample tested and does not apply to the bulk.  
 This report is issued in confidence to the client and it will be strictly treated as such by the SHENZHEN TIMEWAY TESTING LABORATORIES. It may not be reproduced rather in its entirety or in part and it may not be used for adverting. The client to whom the report is issued may, however, show or send it . or a certified copy there of prepared by the SHENZHEN TIMEWAY TESTING LABORATORIES. to his customer. Supplier or others persons directly concerned. SHENZHEN TIMEWAY TESTING LABORATORIES. will not, without the consent of the client enter into any discussion of correspondence with any third party concerning the contents of the report.  
 In the event of the improper use of the report. The SHENZHEN TIMEWAY TESTING LABORATORIES. reserves the rights to withdraw it and to adopt any other remedies which may be appropriate.





8. 802.11g at 6Mbps of CH6

	Marker 1 [T1]	RBW	10 kHz	RF Att	20 dB
	Ref Lvl	-11.47 dBm	VBW	30 kHz	
	10 dBm	2.43324602 GHz	SWT	600 ms	Unit dBm

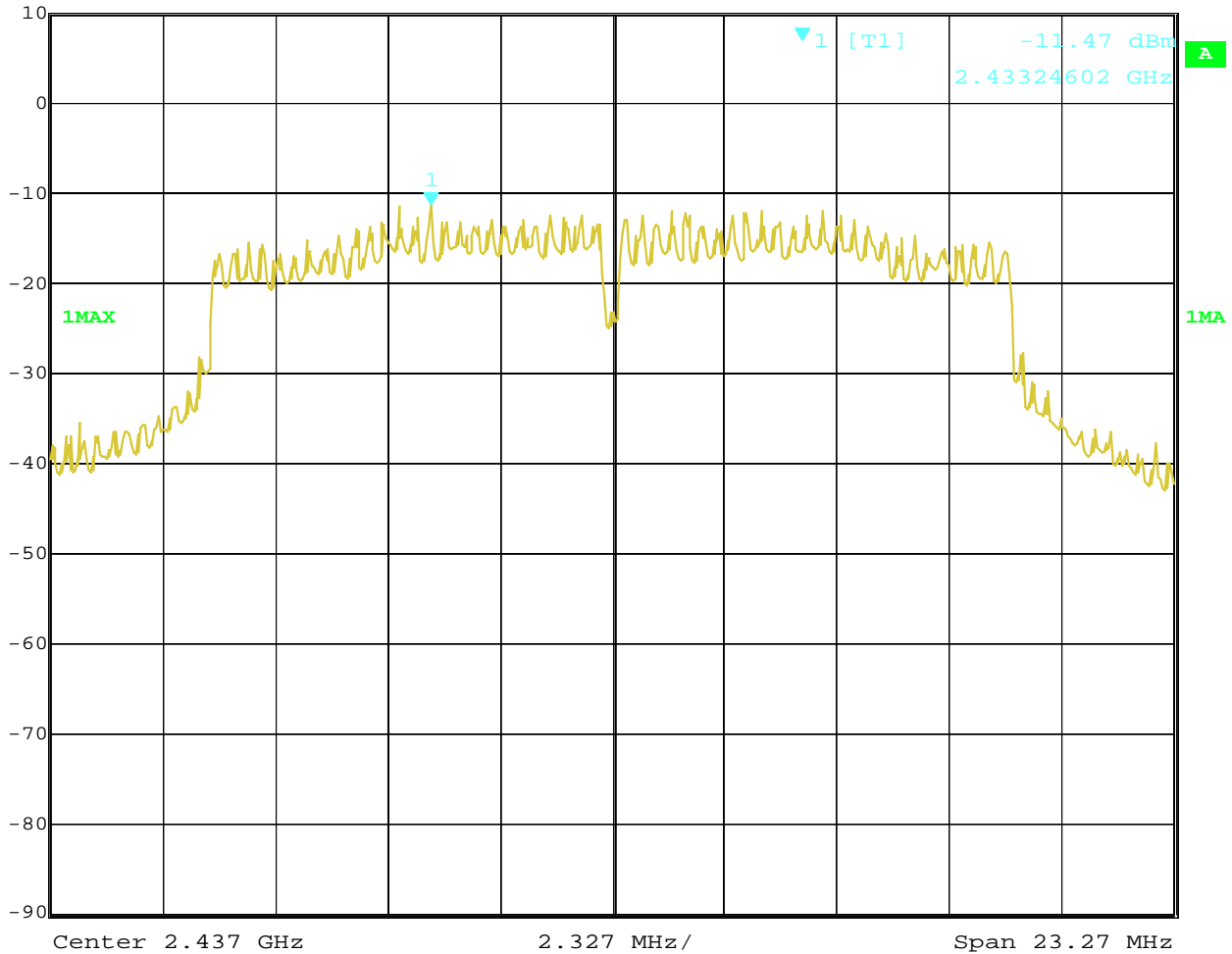

Date: 29.SEP.2021 14:32:07

The report refers only to the sample tested and does not apply to the bulk.  
 This report is issued in confidence to the client and it will be strictly treated as such by the SHENZHEN TIMEWAY TESTING LABORATORIES. It may not be reproduced rather in its entirety or in part and it may not be used for adverting. The client to whom the report is issued may, however, show or send it . or a certified copy there of prepared by the SHENZHEN TIMEWAY TESTING LABORATORIES. to his customer. Supplier or others persons directly concerned. SHENZHEN TIMEWAY TESTING LABORATORIES. will not, without the consent of the client enter into any discussion of correspondence with any third party concerning the contents of the report.  
 In the event of the improper use of the report. The SHENZHEN TIMEWAY TESTING LABORATORIES. reserves the rights to withdraw it and to adopt any other remedies which may be appropriate.



9. 802.11g at 6Mbps of CH11

	Marker 1 [T1]	RBW	10 kHz	RF Att	20 dB
	Ref Lvl	-11.74 dBm	VBW	30 kHz	
	10 dBm	2.46323578 GHz	SWT	600 ms	Unit dBm

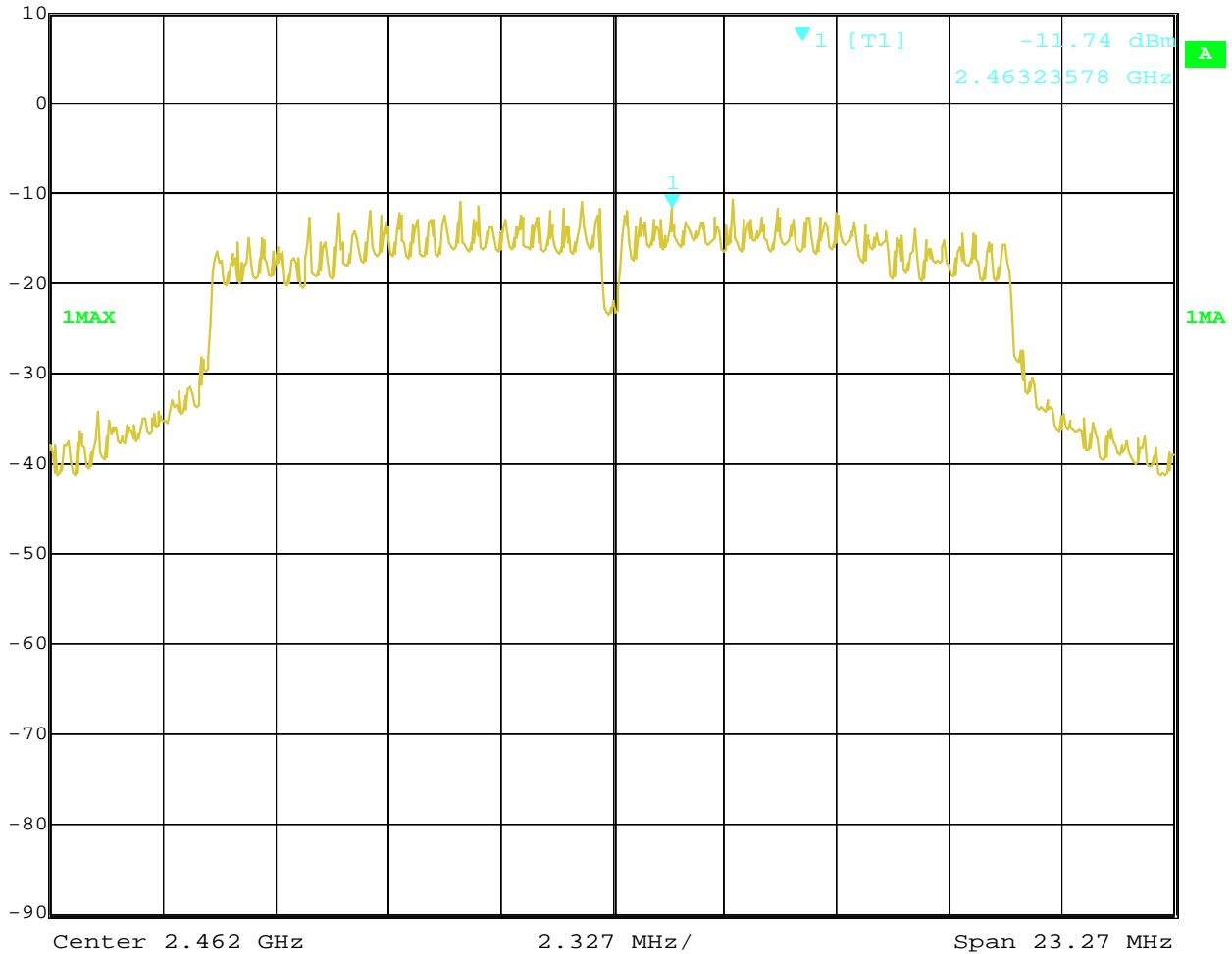

Date: 29.SEP.2021 14:37:42

The report refers only to the sample tested and does not apply to the bulk.  
 This report is issued in confidence to the client and it will be strictly treated as such by the SHENZHEN TIMEWAY TESTING LABORATORIES. It may not be reproduced rather in its entirety or in part and it may not be used for advertising. The client to whom the report is issued may, however, show or send it . or a certified copy there of prepared by the SHENZHEN TIMEWAY TESTING LABORATORIES. to his customer. Supplier or others persons directly concerned. SHENZHEN TIMEWAY TESTING LABORATORIES. will not, without the consent of the client enter into any discussion of correspondence with any third party concerning the contents of the report.  
 In the event of the improper use of the report. The SHENZHEN TIMEWAY TESTING LABORATORIES. reserves the rights to withdraw it and to adopt any other remedies which may be appropriate.



10. 802.11n at HT20 of CH01

	Marker 1 [T1]	RBW	10 kHz	RF Att	20 dB
	Ref Lvl	-12.49 dBm	VBW	30 kHz	
	10 dBm	2.41263277 GHz	SWT	640 ms	Unit dBm

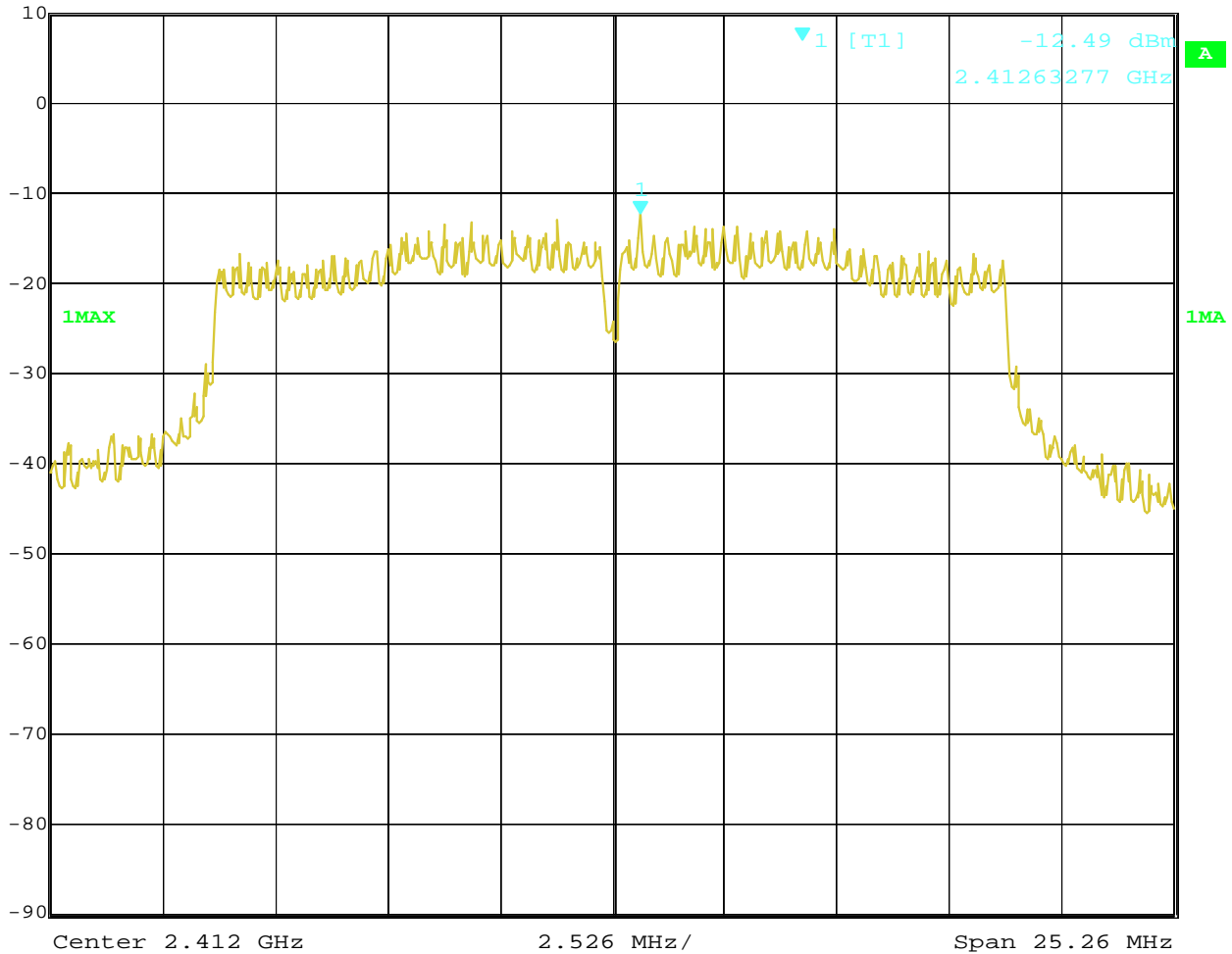

Date: 29.SEP.2021 14:46:13

The report refers only to the sample tested and does not apply to the bulk.  
 This report is issued in confidence to the client and it will be strictly treated as such by the SHENZHEN TIMEWAY TESTING LABORATORIES. It may not be reproduced rather in its entirety or in part and it may not be used for adverting. The client to whom the report is issued may, however, show or send it . or a certified copy there of prepared by the SHENZHEN TIMEWAY TESTING LABORATORIES. to his customer. Supplier or others persons directly concerned. SHENZHEN TIMEWAY TESTING LABORATORIES. will not, without the consent of the client enter into any discussion of correspondence with any third party concerning the contents of the report.  
 In the event of the improper use of the report. The SHENZHEN TIMEWAY TESTING LABORATORIES. reserves the rights to withdraw it and to adopt any other remedies which may be appropriate.



11. 802.11n at HT20 of CH06

	Marker 1 [T1]	RBW	10 kHz	RF Att	20 dB
	Ref Lvl	-11.48 dBm	VBW	30 kHz	
	10 dBm	2.43636723 GHz	SWT	640 ms	Unit dBm

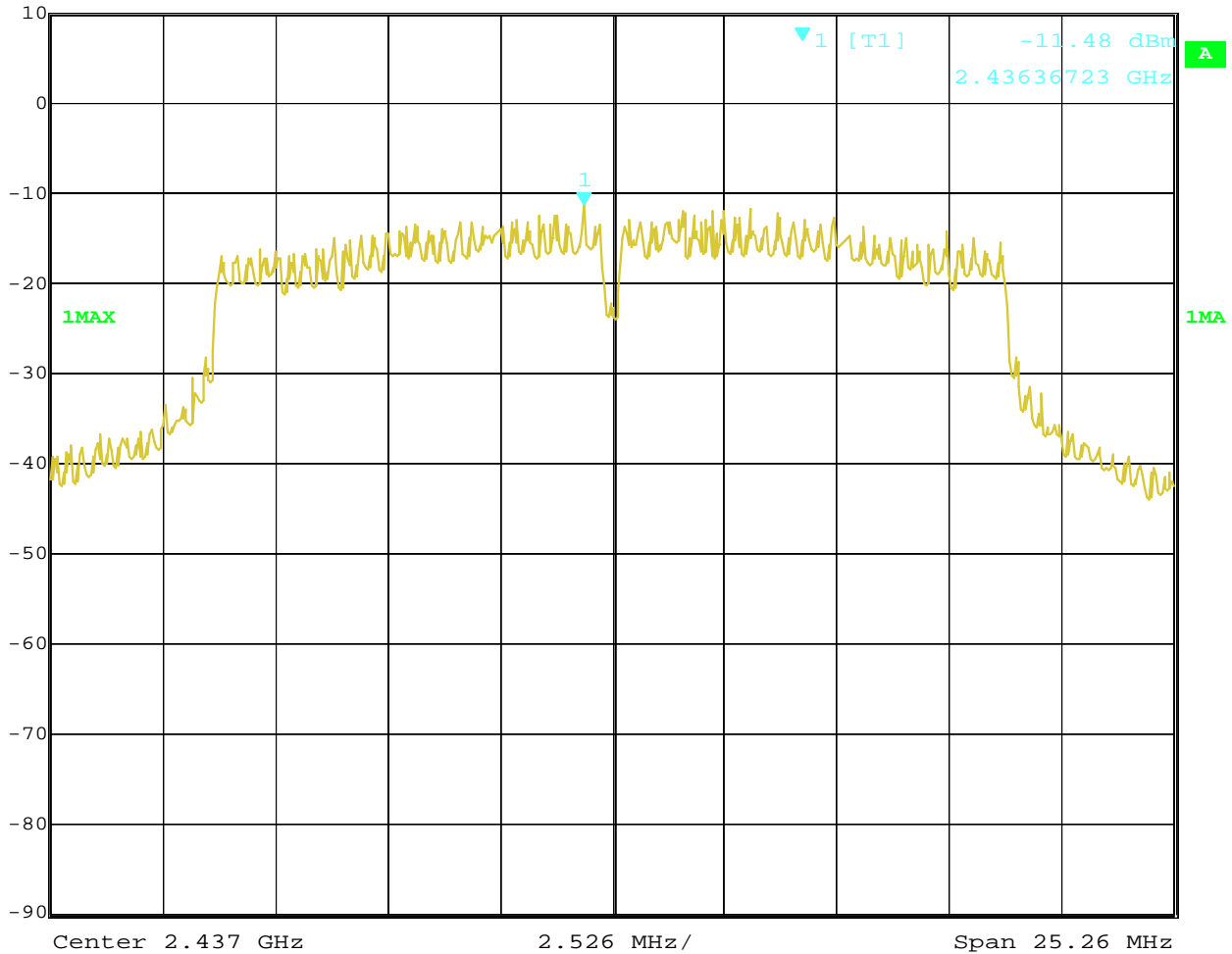

Date: 29.SEP.2021 14:47:22

The report refers only to the sample tested and does not apply to the bulk.  
 This report is issued in confidence to the client and it will be strictly treated as such by the SHENZHEN TIMEWAY TESTING LABORATORIES. It may not be reproduced rather in its entirety or in part and it may not be used for adverting. The client to whom the report is issued may, however, show or send it . or a certified copy there of prepared by the SHENZHEN TIMEWAY TESTING LABORATORIES. to his customer. Supplier or others persons directly concerned. SHENZHEN TIMEWAY TESTING LABORATORIES. will not, without the consent of the client enter into any discussion of correspondence with any third party concerning the contents of the report.  
 In the event of the improper use of the report. The SHENZHEN TIMEWAY TESTING LABORATORIES. reserves the rights to withdraw it and to adopt any other remedies which may be appropriate.



12. 802.11n at HT20 of CH11

	Marker 1 [T1]	RBW	10 kHz	RF Att	20 dB
	Ref Lvl	-10.88 dBm	VBW	30 kHz	
	10 dBm	2.46384768 GHz	SWT	640 ms	Unit dBm

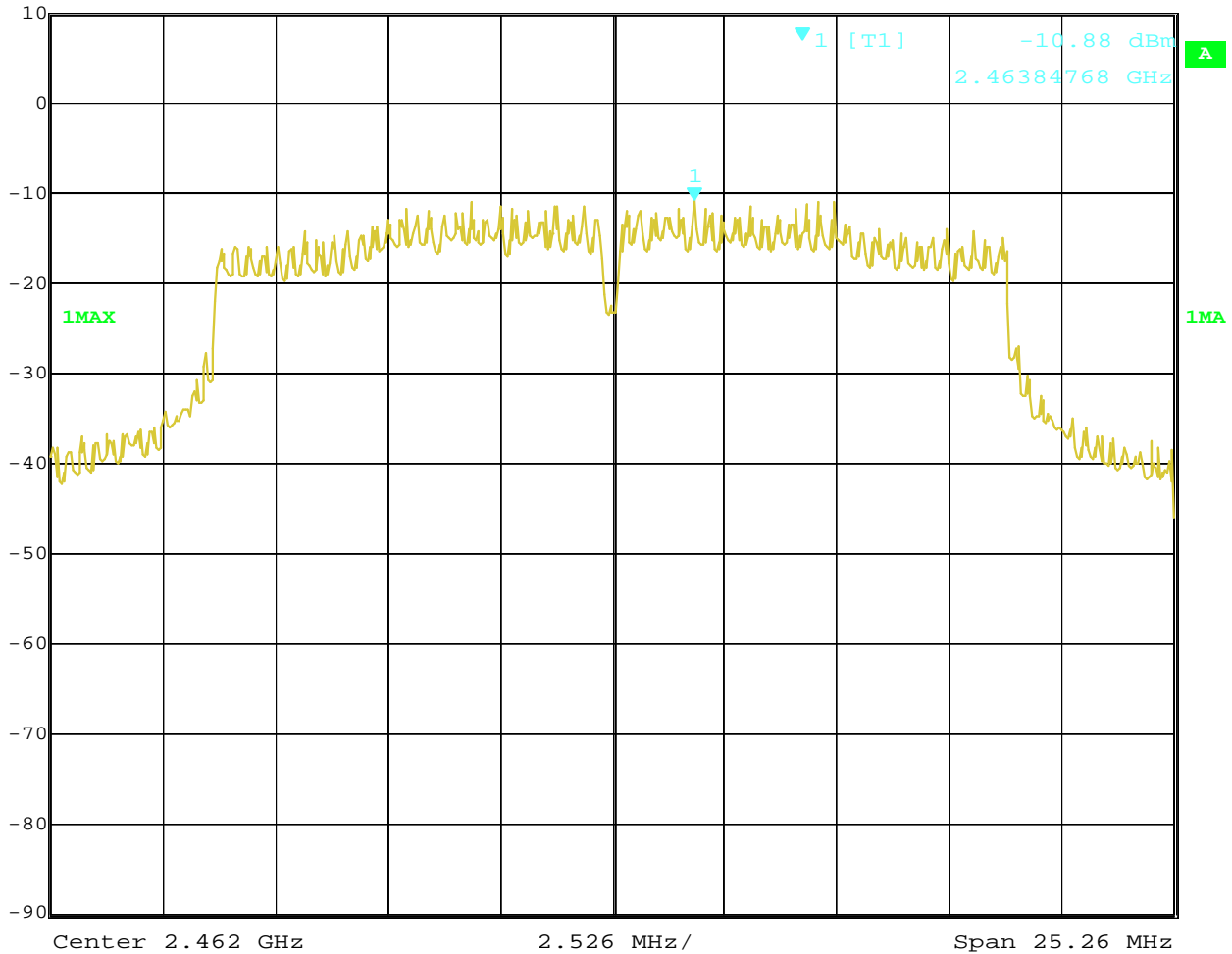

Date: 29.SEP.2021 14:48:27

The report refers only to the sample tested and does not apply to the bulk.  
 This report is issued in confidence to the client and it will be strictly treated as such by the SHENZHEN TIMEWAY TESTING LABORATORIES. It may not be reproduced rather in its entirety or in part and it may not be used for adverting. The client to whom the report is issued may, however, show or send it . or a certified copy there of prepared by the SHENZHEN TIMEWAY TESTING LABORATORIES. to his customer. Supplier or others persons directly concerned. SHENZHEN TIMEWAY TESTING LABORATORIES. will not, without the consent of the client enter into any discussion of correspondence with any third party concerning the contents of the report.  
 In the event of the improper use of the report. The SHENZHEN TIMEWAY TESTING LABORATORIES. reserves the rights to withdraw it and to adopt any other remedies which may be appropriate.



13. 802.11n at HT40 of CH01

	Marker 1 [T1]	RBW	10 kHz	RF Att	20 dB
	Ref Lvl	-15.57 dBm	VBW	30 kHz	
	10 dBm	2.41694920 GHz	SWT	1.35 s	Unit dBm

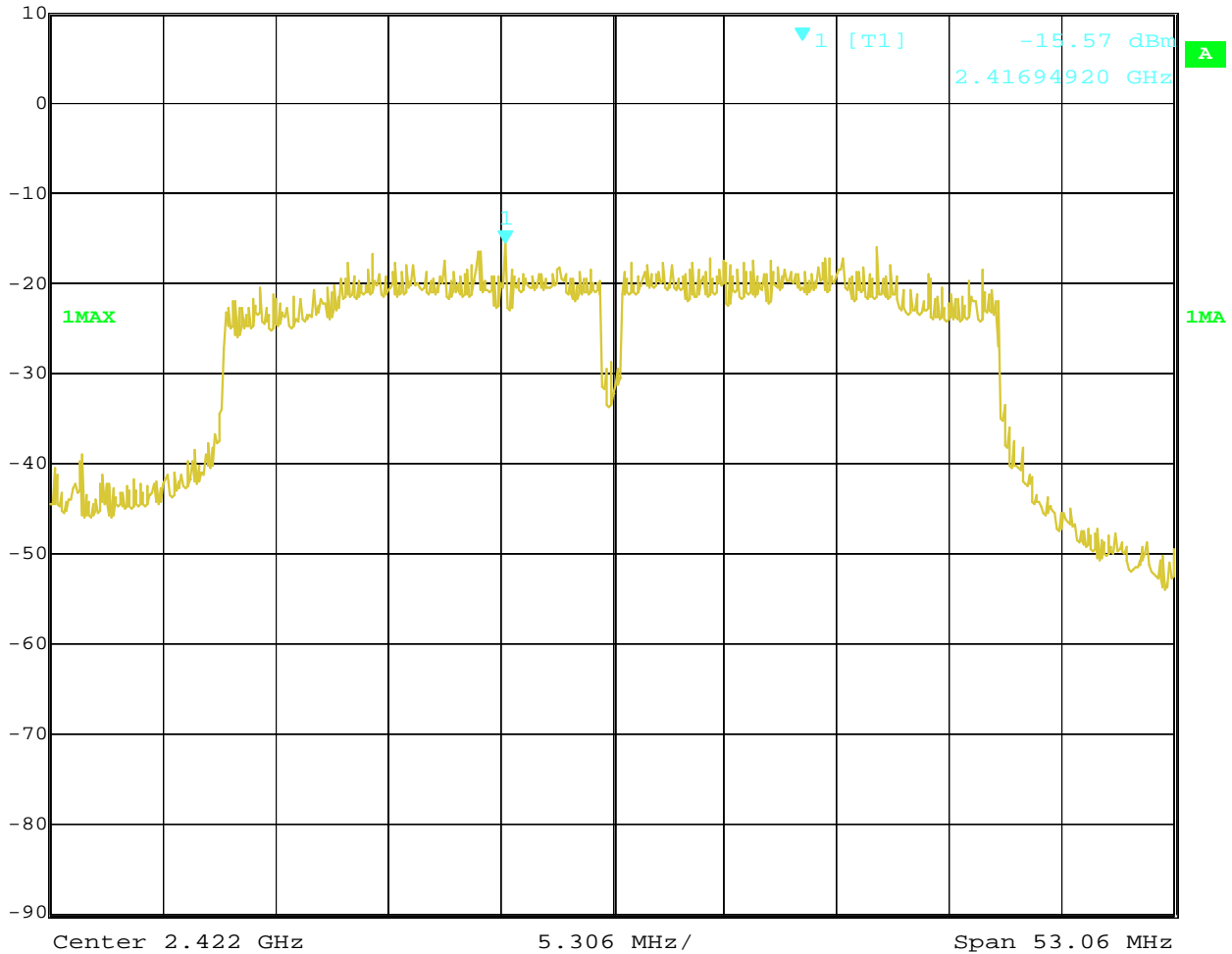

Date: 29.SEP.2021 14:49:25

The report refers only to the sample tested and does not apply to the bulk.  
 This report is issued in confidence to the client and it will be strictly treated as such by the SHENZHEN TIMEWAY TESTING LABORATORIES. It may not be reproduced rather in its entirety or in part and it may not be used for adverting. The client to whom the report is issued may, however, show or send it . or a certified copy there of prepared by the SHENZHEN TIMEWAY TESTING LABORATORIES. to his customer. Supplier or others persons directly concerned. SHENZHEN TIMEWAY TESTING LABORATORIES. will not, without the consent of the client enter into any discussion of correspondence with any third party concerning the contents of the report.  
 In the event of the improper use of the report. The SHENZHEN TIMEWAY TESTING LABORATORIES. reserves the rights to withdraw it and to adopt any other remedies which may be appropriate.



14. 802.11n at HT40 of CH04

	Marker 1 [T1]	RBW	10 kHz	RF Att	20 dB
	Ref Lvl	-15.09 dBm	VBW	30 kHz	
	10 dBm	2.43450118 GHz	SWT	1.35 s	Unit dBm

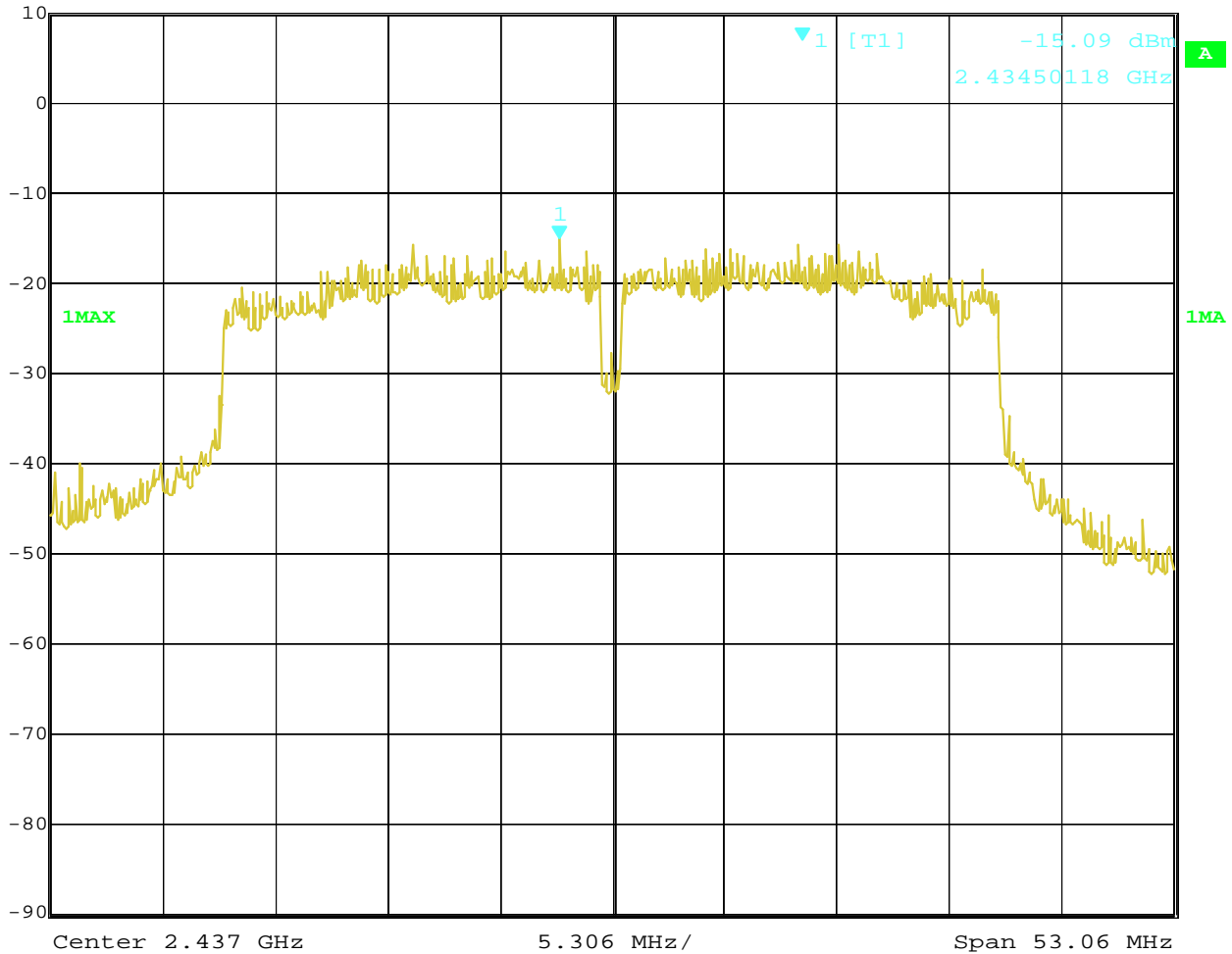

Date: 29.SEP.2021 14:50:02

The report refers only to the sample tested and does not apply to the bulk.  
 This report is issued in confidence to the client and it will be strictly treated as such by the SHENZHEN TIMEWAY TESTING LABORATORIES. It may not be reproduced rather in its entirety or in part and it may not be used for advertising. The client to whom the report is issued may, however, show or send it . or a certified copy there of prepared by the SHENZHEN TIMEWAY TESTING LABORATORIES. to his customer. Supplier or others persons directly concerned. SHENZHEN TIMEWAY TESTING LABORATORIES. will not, without the consent of the client enter into any discussion of correspondence with any third party concerning the contents of the report.  
 In the event of the improper use of the report. The SHENZHEN TIMEWAY TESTING LABORATORIES. reserves the rights to withdraw it and to adopt any other remedies which may be appropriate.



15. 802.11n at HT40 of CH07

	Marker 1 [T1]	RBW	10 kHz	RF Att	20 dB
	Ref Lvl	-15.08 dBm	VBW	30 kHz	
	10 dBm	2.44950118 GHz	SWT	1.35 s	Unit dBm

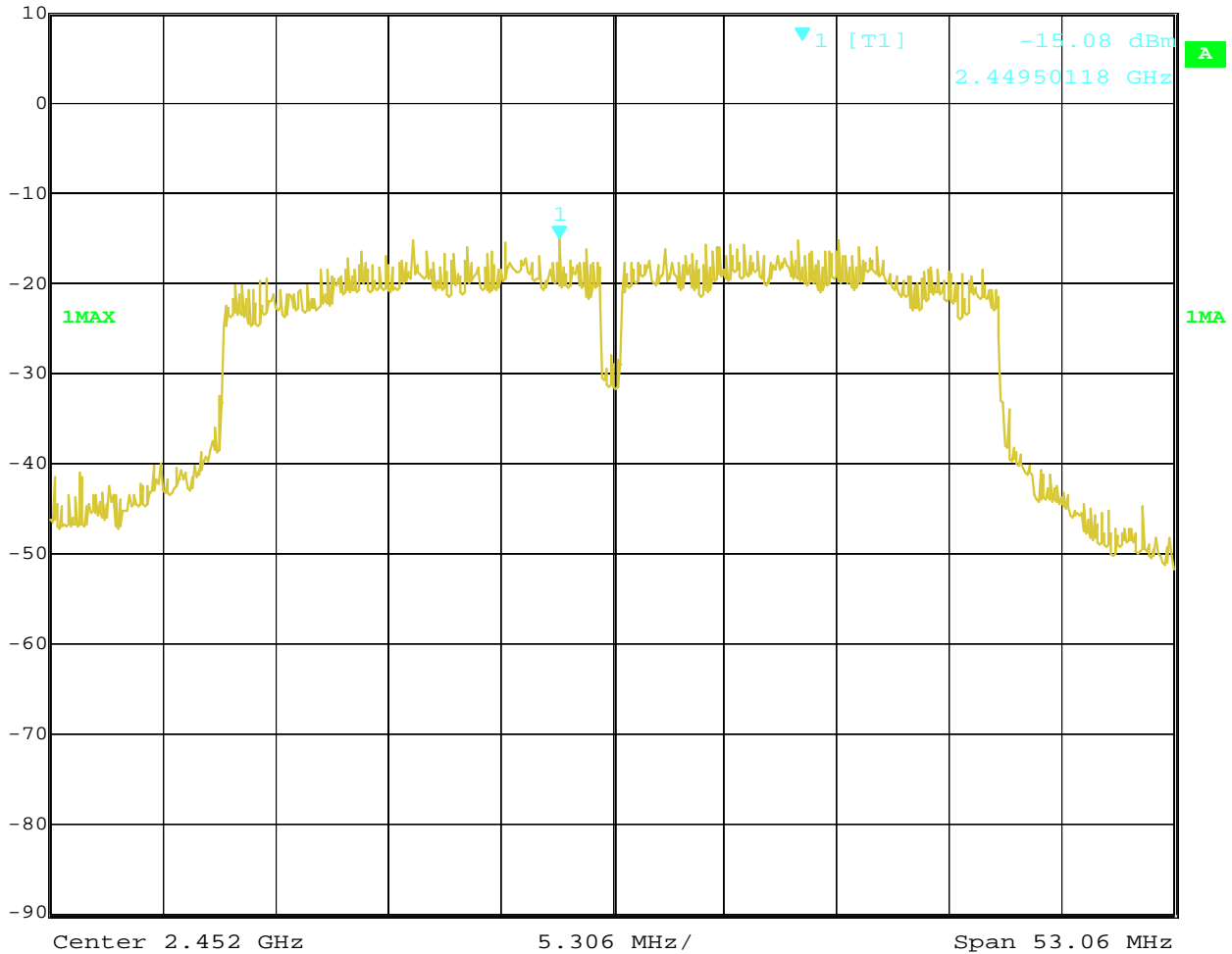

Date: 29.SEP.2021 14:50:50

The report refers only to the sample tested and does not apply to the bulk.  
 This report is issued in confidence to the client and it will be strictly treated as such by the SHENZHEN TIMEWAY TESTING LABORATORIES. It may not be reproduced rather in its entirety or in part and it may not be used for adverting. The client to whom the report is issued may, however, show or send it . or a certified copy there of prepared by the SHENZHEN TIMEWAY TESTING LABORATORIES. to his customer. Supplier or others persons directly concerned. SHENZHEN TIMEWAY TESTING LABORATORIES. will not, without the consent of the client enter into any discussion of correspondence with any third party concerning the contents of the report.  
 In the event of the improper use of the report. The SHENZHEN TIMEWAY TESTING LABORATORIES. reserves the rights to withdraw it and to adopt any other remedies which may be appropriate.





## 10 Out of Band Measurement

### 10.1 Test Setup for band edge

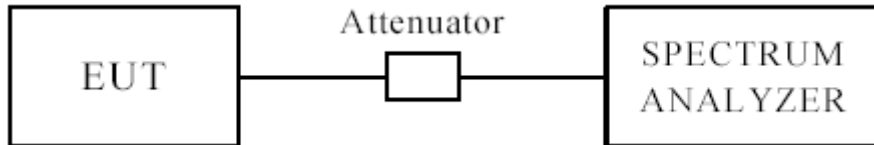

**The restricted band requirement based on radiated emission test; please see the clause 6 for the test setup**

### 10.2 Limits of Out of Band Emissions Measurement

1. Below  $-20\text{dB}$  of the highest emission level of operating band (in 100kHz Resolution Bandwidth).
2. Fall in the restricted bands listed in section 15.205. The maximum permitted average field strength is listed in section 15.209.

### 10.3 Test Procedure

For signals in the restricted bands above and below the 2.4-2.483GHz allocated band a measurement was made of radiated emission test.( Peak values with RBW=VBW=1MHz and PK detector. AV value with RBW=1MHz, VBW=10Hz and PK detector)

For bandage test, the spectrum set as follows: RBW=100, VBW=300 kHz. A conducted measurement used

### 10.4 Test Result

Please see next pages

Note: 1. For band-edge measurement, the frequency from 30MHz-25GHz was tested. And It met the FCC rule.

The report refers only to the sample tested and does not apply to the bulk.

This report is issued in confidence to the client and it will be strictly treated as such by the SHENZHEN TIMEWAY TESTING LABORATORIES. It may not be reproduced rather in its entirety or in part and it may not be used for advertising. The client to whom the report is issued may, however, show or send it . or a certified copy there of prepared by the SHENZHEN TIMEWAY TESTING LABORATORIES. to his customer. Supplier or others persons directly concerned. SHENZHEN TIMEWAY TESTING LABORATORIES. will not, without the consent of the client enter into any discussion of correspondence with any third party concerning the contents of the report.

In the event of the improper use of the report. The SHENZHEN TIMEWAY TESTING LABORATORIES. reserves the rights to withdraw it and to adopt any other remedies which may be appropriate.



For 802.11b mode

CH01 at 1Mbps

**10.4 Band-edge Measurement**

EUT	Wireless Remote Control Outlet	Model	RSN011R
Mode	Keeping Transmitting	Input Voltage	120V~
Temperature	24 deg. C,	Humidity	56% RH
Test Result:	Pass	Detector	PK

**Test Figure:**

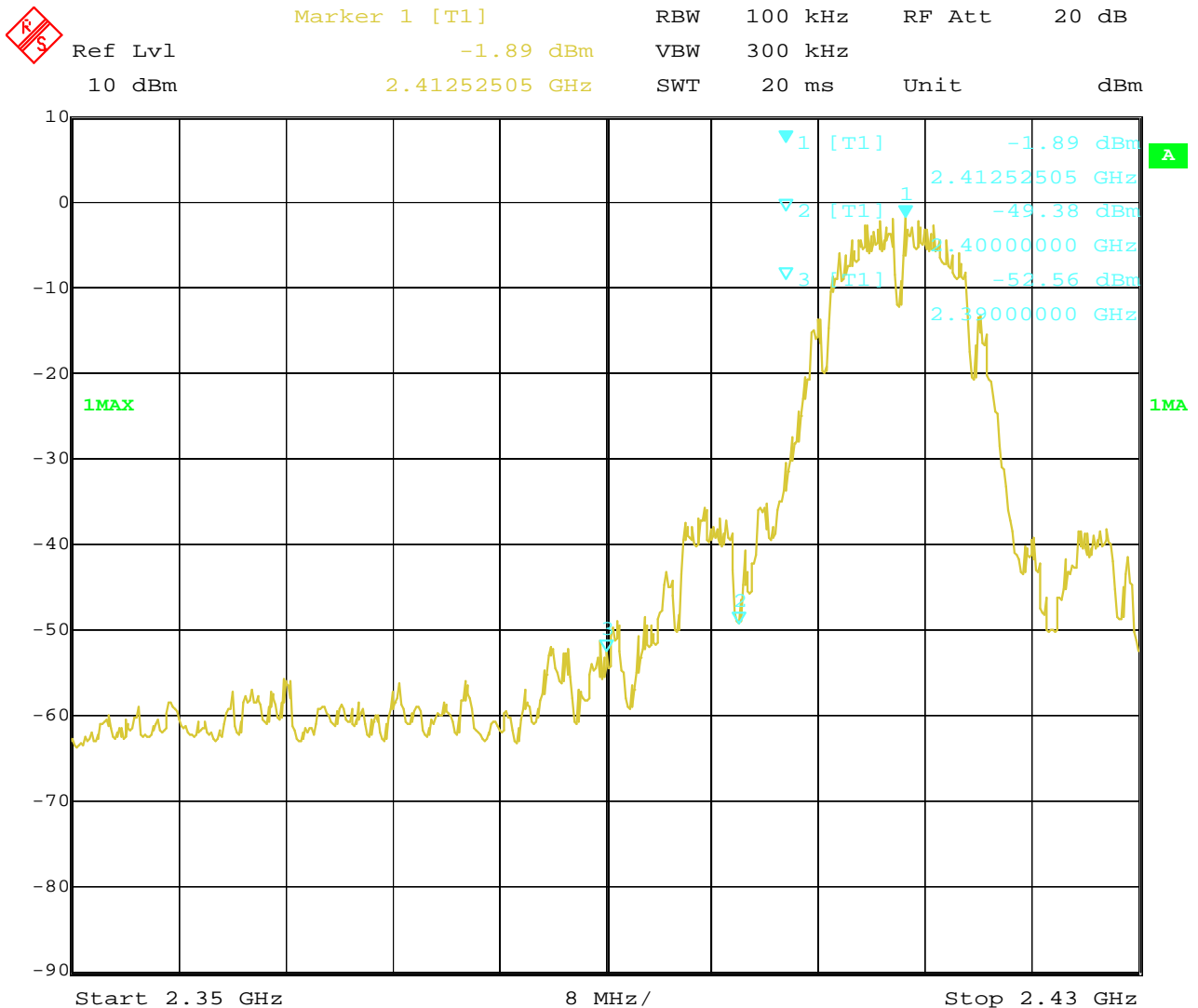

Date: 29.SEP.2021 14:59:51

The report refers only to the sample tested and does not apply to the bulk.  
 This report is issued in confidence to the client and it will be strictly treated as such by the SHENZHEN TIMEWAY TESTING LABORATORIES. It may not be reproduced rather in its entirety or in part and it may not be used for advertising. The client to whom the report is issued may, however, show or send it or a certified copy thereof prepared by the SHENZHEN TIMEWAY TESTING LABORATORIES to his customer. Supplier or others persons directly concerned. SHENZHEN TIMEWAY TESTING LABORATORIES will not, without the consent of the client enter into any discussion of correspondence with any third party concerning the contents of the report.  
 In the event of the improper use of the report. The SHENZHEN TIMEWAY TESTING LABORATORIES reserves the rights to withdraw it and to adopt any other remedies which may be appropriate.



CH11 at 1Mbps

**10.4 Band-edge Measurement**

EUT	Wireless Remote Control Outlet	Model	RSN011R
Mode	Keeping Transmitting	Input Voltage	120V~
Temperature	24 deg. C,	Humidity	56% RH
Test Result:	Pass	Detector	PK

**Test Figure:**

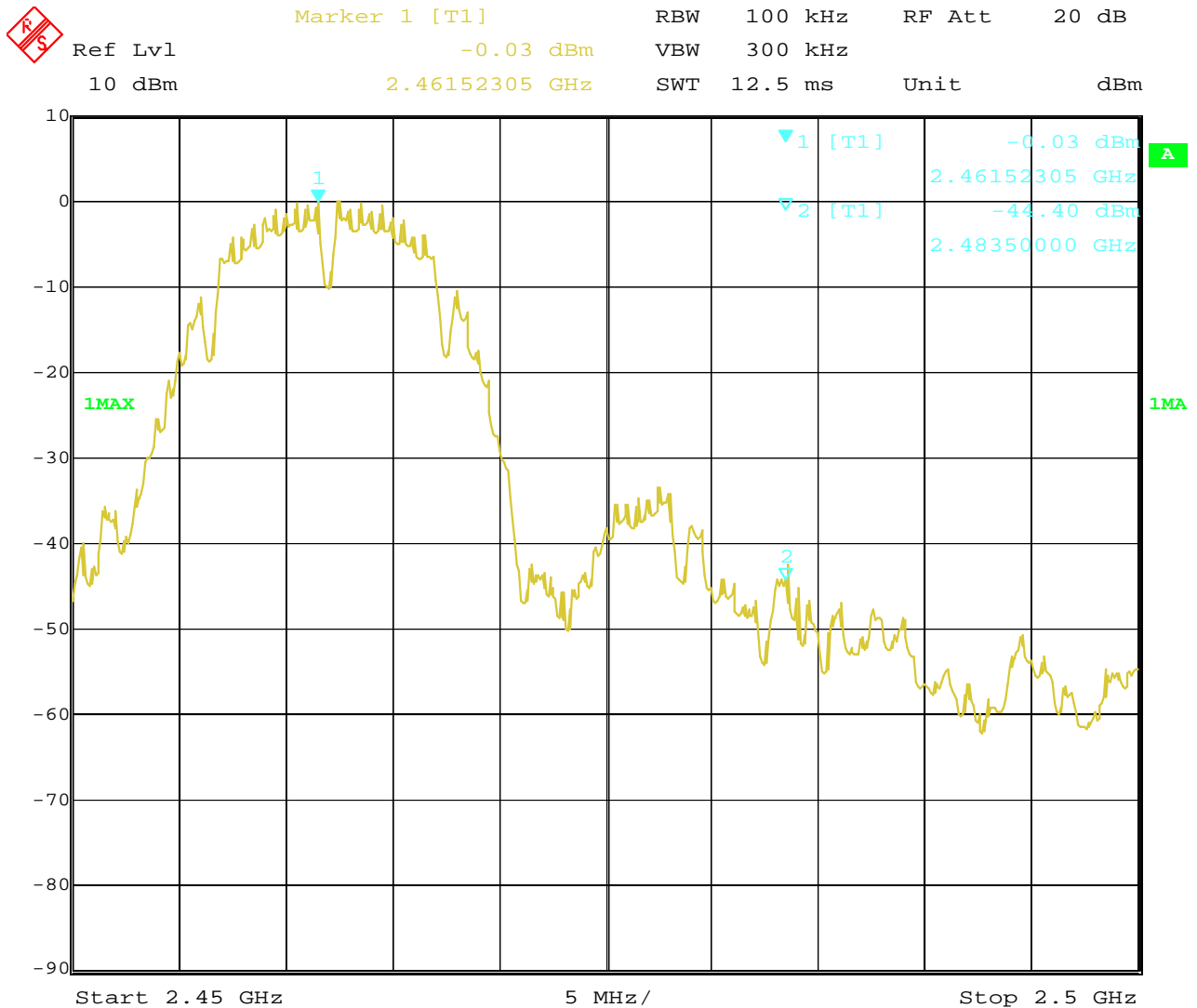

Date: 29.SEP.2021 15:04:10

The report refers only to the sample tested and does not apply to the bulk.  
 This report is issued in confidence to the client and it will be strictly treated as such by the SHENZHEN TIMEWAY TESTING LABORATORIES. It may not be reproduced rather in its entirety or in part and it may not be used for advertising. The client to whom the report is issued may, however, show or send it . or a certified copy there of prepared by the SHENZHEN TIMEWAY TESTING LABORATORIES. to his customer. Supplier or others persons directly concerned. SHENZHEN TIMEWAY TESTING LABORATORIES. will not, without the consent of the client enter into any discussion of correspondence with any third party concerning the contents of the report.  
 In the event of the improper use of the report. The SHENZHEN TIMEWAY TESTING LABORATORIES. reserves the rights to withdraw it and to adopt any other remedies which may be appropriate.



For 802.11b mode

CH01 at 11Mbps

10.4 Band-edge Measurement

EUT	Wireless Remote Control Outlet	Model	RSN011R
Mode	Keeping Transmitting	Input Voltage	120V~
Temperature	24 deg. C,	Humidity	56% RH
Test Result:	Pass	Detector	PK

Test Figure:



Marker 1 [T1] RBW 100 kHz RF Att 20 dB  
 Ref Lvl -2.06 dBm VBW 300 kHz  
 10 dBm 2.41348697 GHz SWT 20 ms Unit dBm

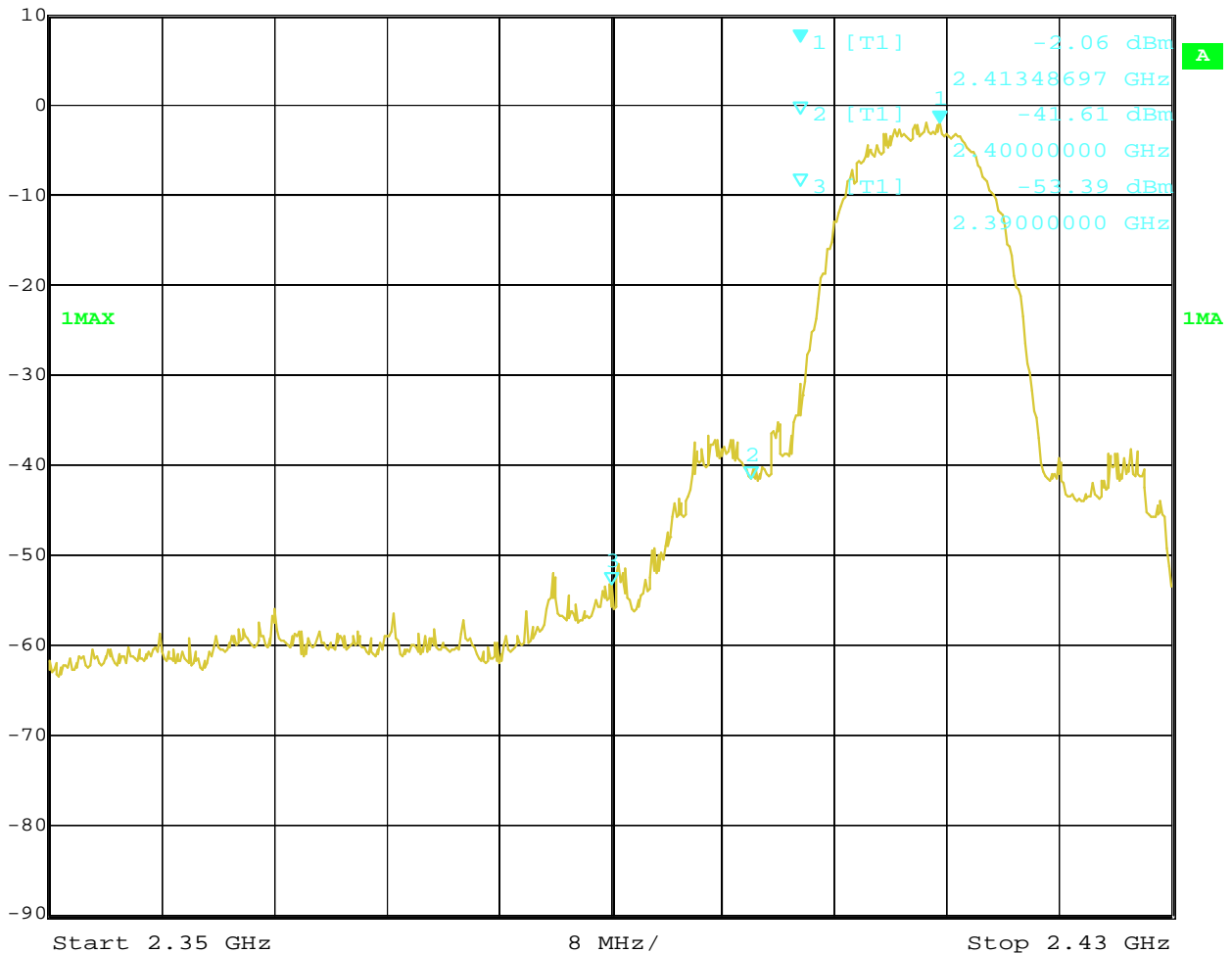

Date: 29.SEP.2021 15:01:04

The report refers only to the sample tested and does not apply to the bulk.  
 This report is issued in confidence to the client and it will be strictly treated as such by the SHENZHEN TIMEWAY TESTING LABORATORIES. It may not be reproduced rather in its entirety or in part and it may not be used for advertising. The client to whom the report is issued may, however, show or send it or a certified copy thereof prepared by the SHENZHEN TIMEWAY TESTING LABORATORIES to his customer. Supplier or others persons directly concerned. SHENZHEN TIMEWAY TESTING LABORATORIES will not, without the consent of the client enter into any discussion of correspondence with any third party concerning the contents of the report.  
 In the event of the improper use of the report. The SHENZHEN TIMEWAY TESTING LABORATORIES reserves the rights to withdraw it and to adopt any other remedies which may be appropriate.



CH11 at 11Mbps

**10.4 Band-edge Measurement**

EUT	Wireless Remote Control Outlet	Model	RSN011R
Mode	Keeping Transmitting	Input Voltage	120V~
Temperature	24 deg. C,	Humidity	56% RH
Test Result:	Pass	Detector	PK

**Test Figure:**

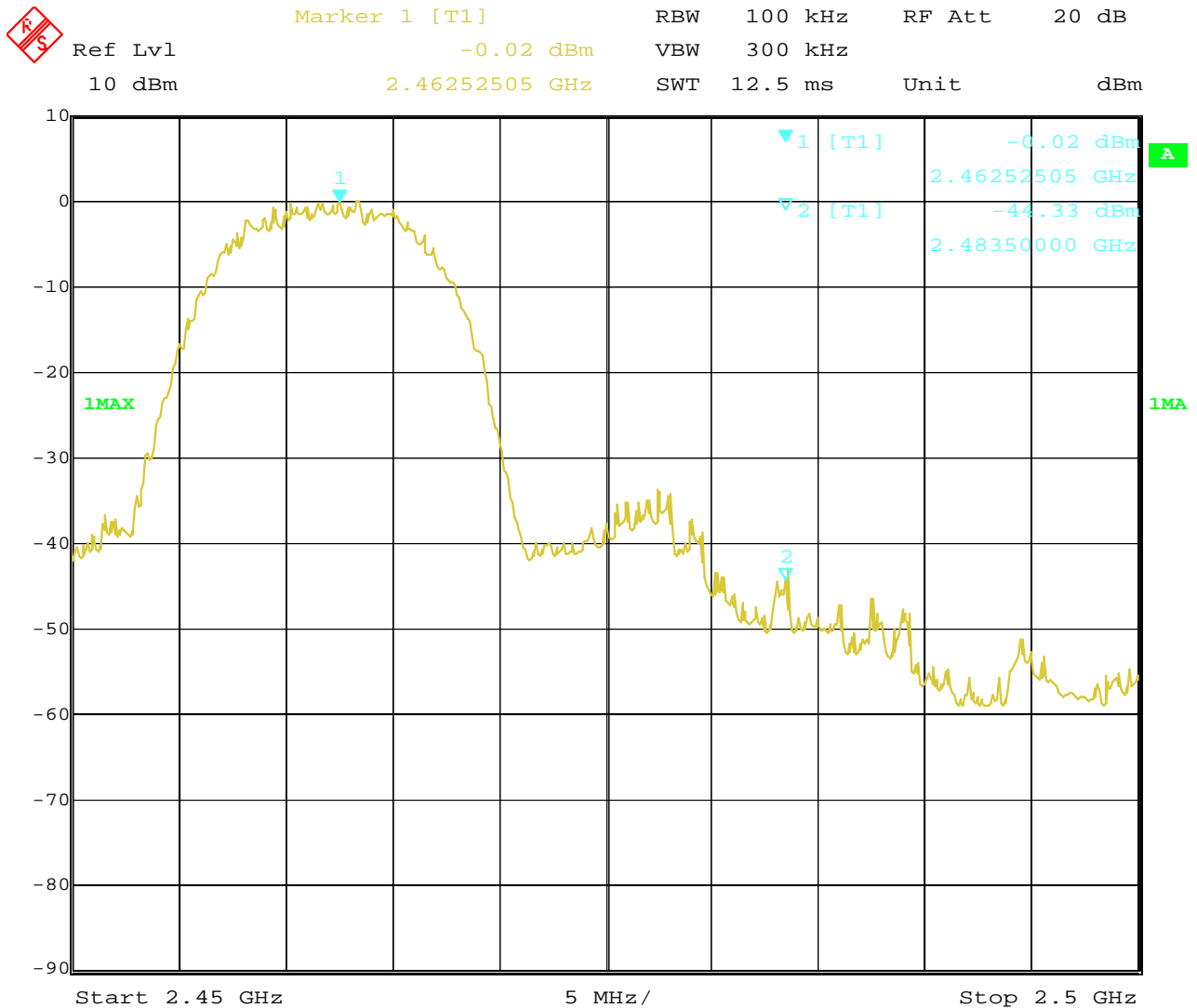

Date: 29.SEP.2021 15:02:03

The report refers only to the sample tested and does not apply to the bulk.  
 This report is issued in confidence to the client and it will be strictly treated as such by the SHENZHEN TIMEWAY TESTING LABORATORIES. It may not be reproduced rather in its entirety or in part and it may not be used for advertising. The client to whom the report is issued may, however, show or send it . or a certified copy there of prepared by the SHENZHEN TIMEWAY TESTING LABORATORIES. to his customer. Supplier or others persons directly concerned. SHENZHEN TIMEWAY TESTING LABORATORIES. will not, without the consent of the client enter into any discussion of correspondence with any third party concerning the contents of the report.  
 In the event of the improper use of the report. The SHENZHEN TIMEWAY TESTING LABORATORIES. reserves the rights to withdraw it and to adopt any other remedies which may be appropriate.



For 802.11g mode

CH01 at 6Mbps

**10.4 Band-edge Measurement**

EUT	Wireless Remote Control Outlet	Model	RSN011R
Mode	Keeping Transmitting	Input Voltage	120V~
Temperature	24 deg. C,	Humidity	56% RH
Test Result:	Pass	Detector	PK

**Test Figure:**

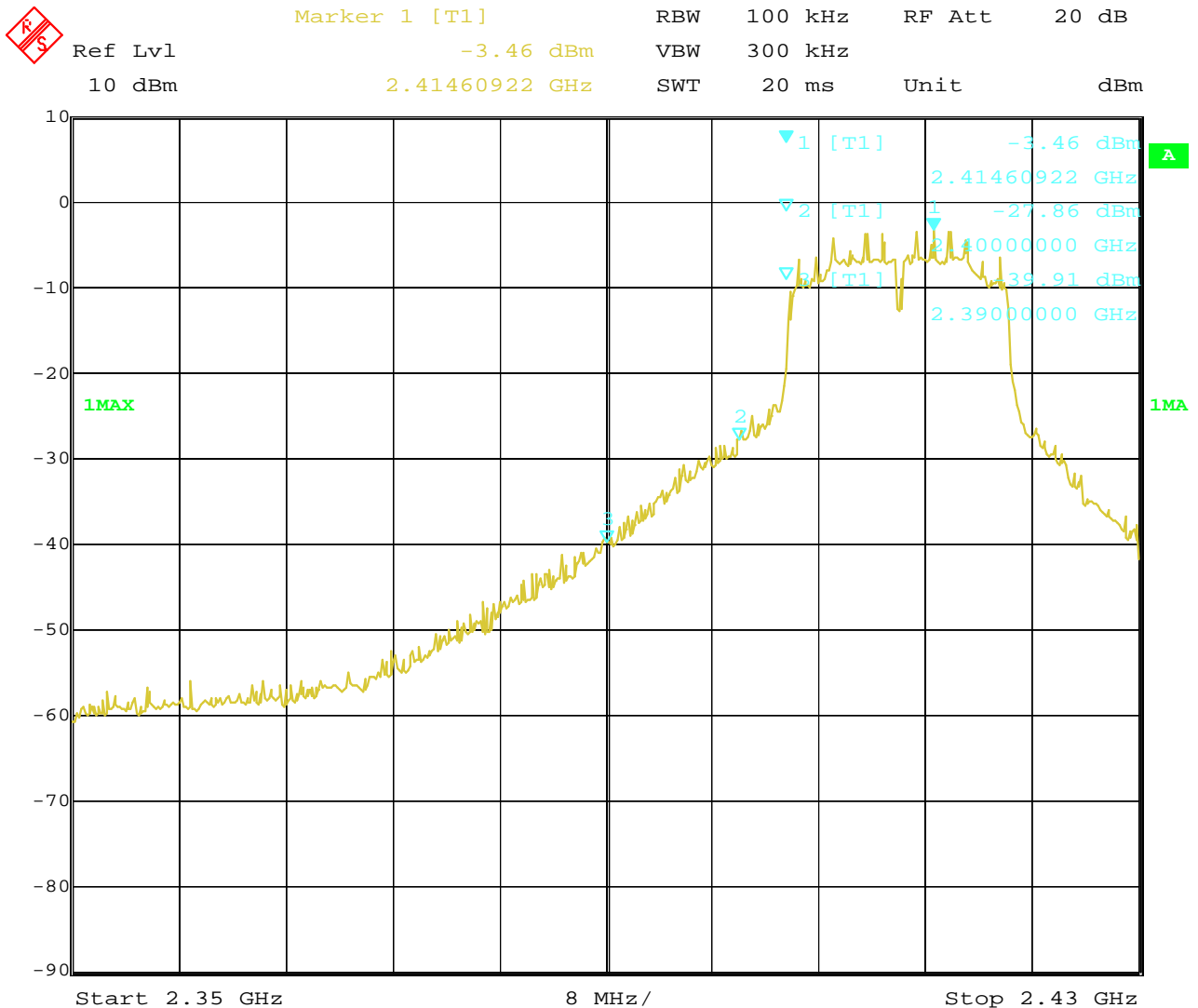

Date: 29.SEP.2021 15:00:33

The report refers only to the sample tested and does not apply to the bulk.  
 This report is issued in confidence to the client and it will be strictly treated as such by the SHENZHEN TIMEWAY TESTING LABORATORIES. It may not be reproduced rather in its entirety or in part and it may not be used for advertising. The client to whom the report is issued may, however, show or send it or a certified copy thereof prepared by the SHENZHEN TIMEWAY TESTING LABORATORIES to his customer. Supplier or others persons directly concerned. SHENZHEN TIMEWAY TESTING LABORATORIES will not, without the consent of the client enter into any discussion of correspondence with any third party concerning the contents of the report.  
 In the event of the improper use of the report. The SHENZHEN TIMEWAY TESTING LABORATORIES reserves the rights to withdraw it and to adopt any other remedies which may be appropriate.



CH11 at 6Mbps

**10.4 Band-edge Measurement**

EUT	Wireless Remote Control Outlet	Model	RSN011R
Mode	Keeping Transmitting	Input Voltage	120V~
Temperature	24 deg. C,	Humidity	56% RH
Test Result:	Pass	Detector	PK

**Test Figure:**

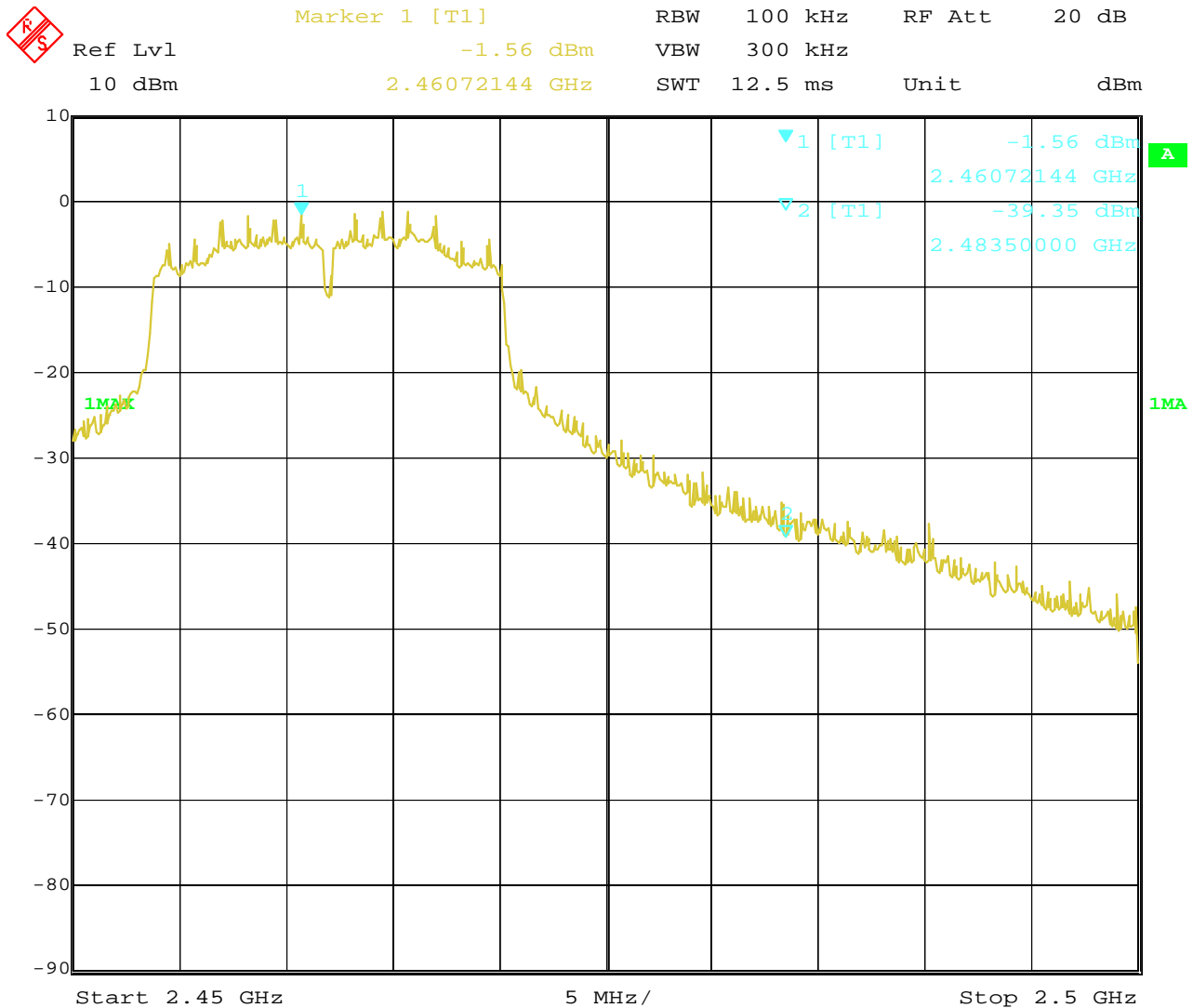

Date: 29.SEP.2021 15:03:10

The report refers only to the sample tested and does not apply to the bulk.  
 This report is issued in confidence to the client and it will be strictly treated as such by the SHENZHEN TIMEWAY TESTING LABORATORIES. It may not be reproduced rather in its entirety or in part and it may not be used for advertising. The client to whom the report is issued may, however, show or send it . or a certified copy there of prepared by the SHENZHEN TIMEWAY TESTING LABORATORIES. to his customer. Supplier or others persons directly concerned. SHENZHEN TIMEWAY TESTING LABORATORIES. will not, without the consent of the client enter into any discussion of correspondence with any third party concerning the contents of the report.  
 In the event of the improper use of the report. The SHENZHEN TIMEWAY TESTING LABORATORIES. reserves the rights to withdraw it and to adopt any other remedies which may be appropriate.



For 802.11n (HT20) mode

CH01 at mcs0

**10.4 Band-edge Measurement**

EUT	Wireless Remote Control Outlet	Model	RSN011R
Mode	Keeping Transmitting	Input Voltage	120V~
Temperature	24 deg. C,	Humidity	56% RH
Test Result:	Pass	Detector	PK

**Test Figure:**

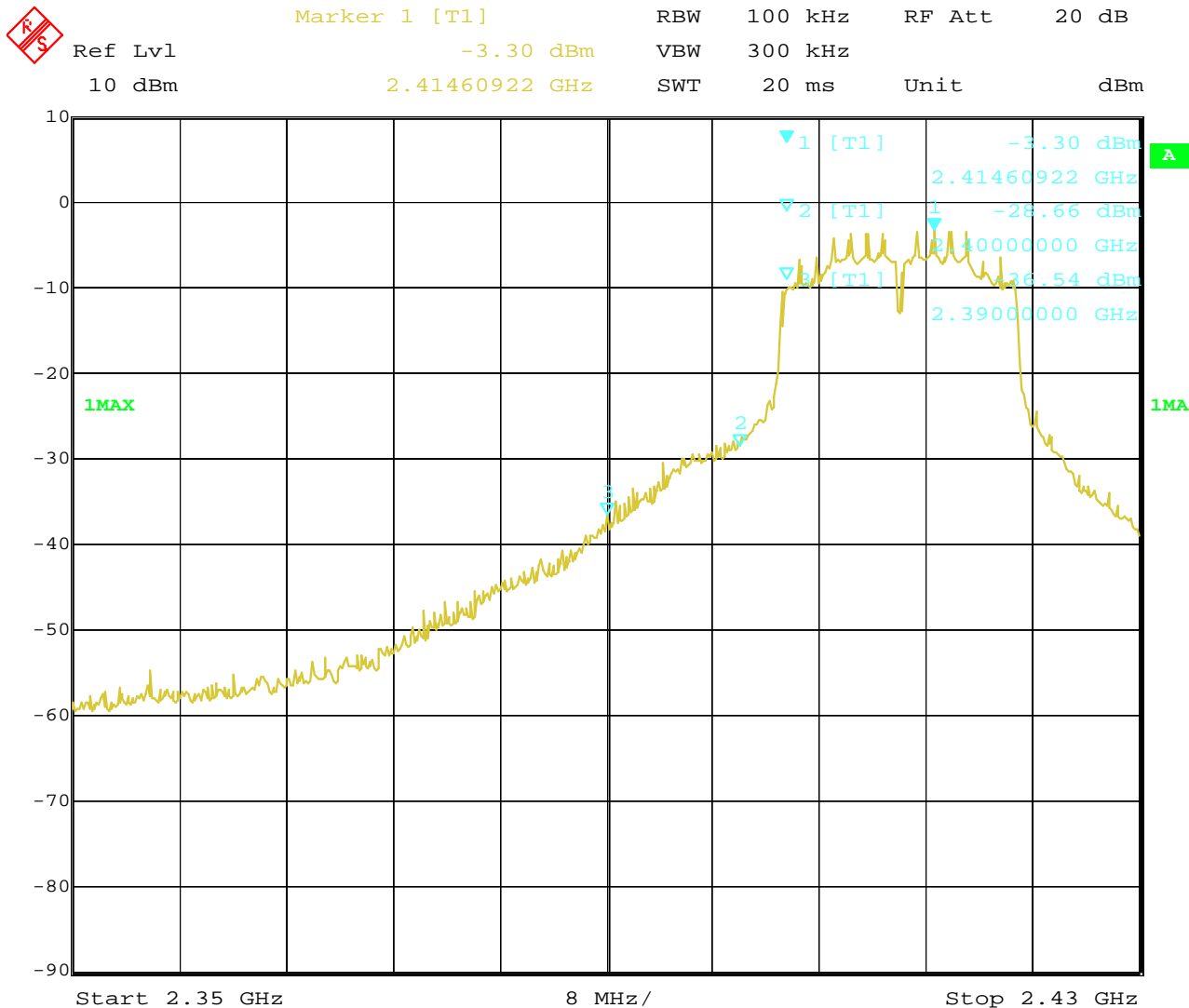

Date: 29.SEP.2021 14:58:33

The report refers only to the sample tested and does not apply to the bulk.  
 This report is issued in confidence to the client and it will be strictly treated as such by the SHENZHEN TIMEWAY TESTING LABORATORIES. It may not be reproduced rather in its entirety or in part and it may not be used for advertising. The client to whom the report is issued may, however, show or send it or a certified copy thereof prepared by the SHENZHEN TIMEWAY TESTING LABORATORIES to his customer. Supplier or others persons directly concerned. SHENZHEN TIMEWAY TESTING LABORATORIES will not, without the consent of the client enter into any discussion of correspondence with any third party concerning the contents of the report.  
 In the event of the improper use of the report. The SHENZHEN TIMEWAY TESTING LABORATORIES reserves the rights to withdraw it and to adopt any other remedies which may be appropriate.





CH11 at mcs0

**10.4 Band-edge Measurement**

EUT	Wireless Remote Control Outlet	Model	RSN011R
Mode	Keeping Transmitting	Input Voltage	120V~
Temperature	24 deg. C,	Humidity	56% RH
Test Result:	Pass	Detector	PK

**Test Figure:**

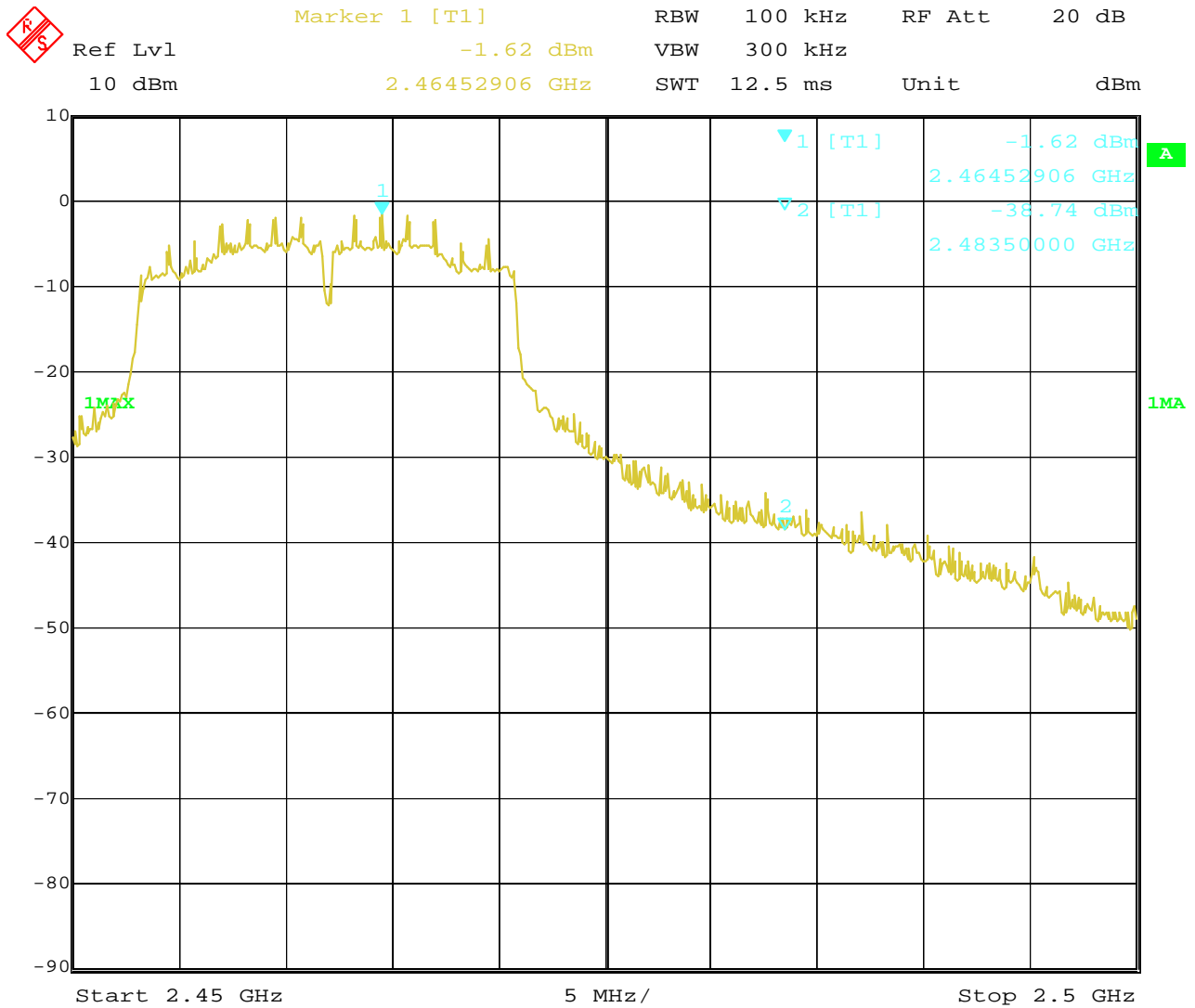

Date: 29.SEP.2021 15:04:58

The report refers only to the sample tested and does not apply to the bulk.  
 This report is issued in confidence to the client and it will be strictly treated as such by the SHENZHEN TIMEWAY TESTING LABORATORIES. It may not be reproduced rather in its entirety or in part and it may not be used for adverting. The client to whom the report is issued may, however, show or send it . or a certified copy there of prepared by the SHENZHEN TIMEWAY TESTING LABORATORIES. to his customer. Supplier or others persons directly concerned. SHENZHEN TIMEWAY TESTING LABORATORIES. will not, without the consent of the client enter into any discussion of correspondence with any third party concerning the contents of the report.  
 In the event of the improper use of the report. The SHENZHEN TIMEWAY TESTING LABORATORIES. reserves the rights to withdraw it and to adopt any other remedies which may be appropriate.



For 802.11n (HT40) mode

CH03 at mcs0

**10.4 Band-edge and Restricted band Measurement**

EUT	Wireless Remote Control Outlet	Model	RSN011R
Mode	Keeping Transmitting	Input Voltage	120V~
Temperature	24 deg. C,	Humidity	56% RH
Test Result:	Pass	Detector	PK

**Test Figure:**

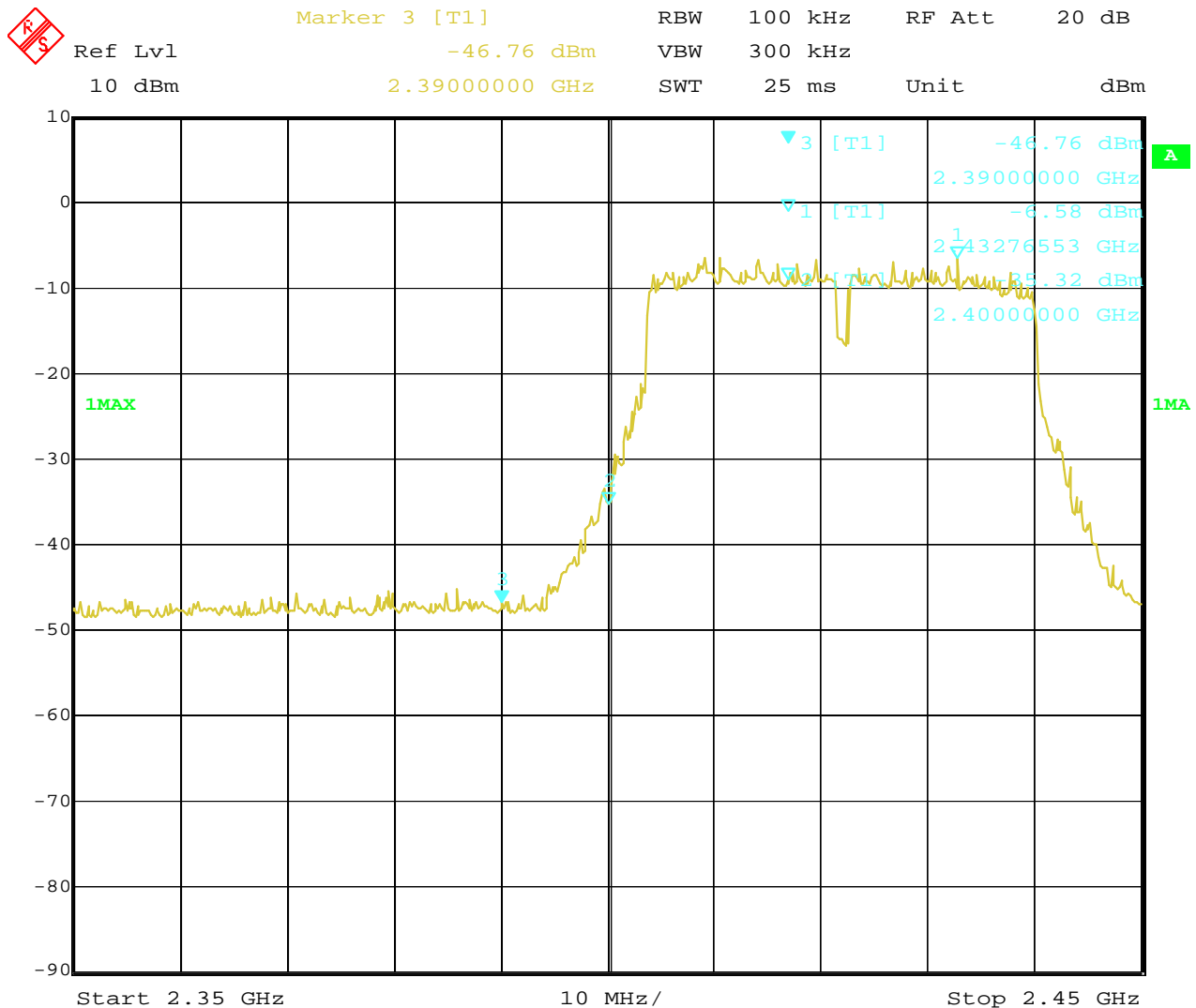

Date: 29.SEP.2021 14:57:00

The report refers only to the sample tested and does not apply to the bulk.  
 This report is issued in confidence to the client and it will be strictly treated as such by the SHENZHEN TIMEWAY TESTING LABORATORIES. It may not be reproduced rather in its entirety or in part and it may not be used for adverting. The client to whom the report is issued may, however, show or send it . or a certified copy there of prepared by the SHENZHEN TIMEWAY TESTING LABORATORIES. to his customer. Supplier or others persons directly concerned. SHENZHEN TIMEWAY TESTING LABORATORIES. will not, without the consent of the client enter into any discussion of correspondence with any third party concerning the contents of the report.  
 In the event of the improper use of the report. The SHENZHEN TIMEWAY TESTING LABORATORIES. reserves the rights to withdraw it and to adopt any other remedies which may be appropriate.



CH09 at mcs0

**10.4 Band-edge and Restricted band Measurement**

EUT	Wireless Remote Control Outlet	Model	RSN011R
Mode	Keeping Transmitting	Input Voltage	120V~
Temperature	24 deg. C,	Humidity	56% RH
Test Result:	Pass	Detector	PK

**Test Figure:**

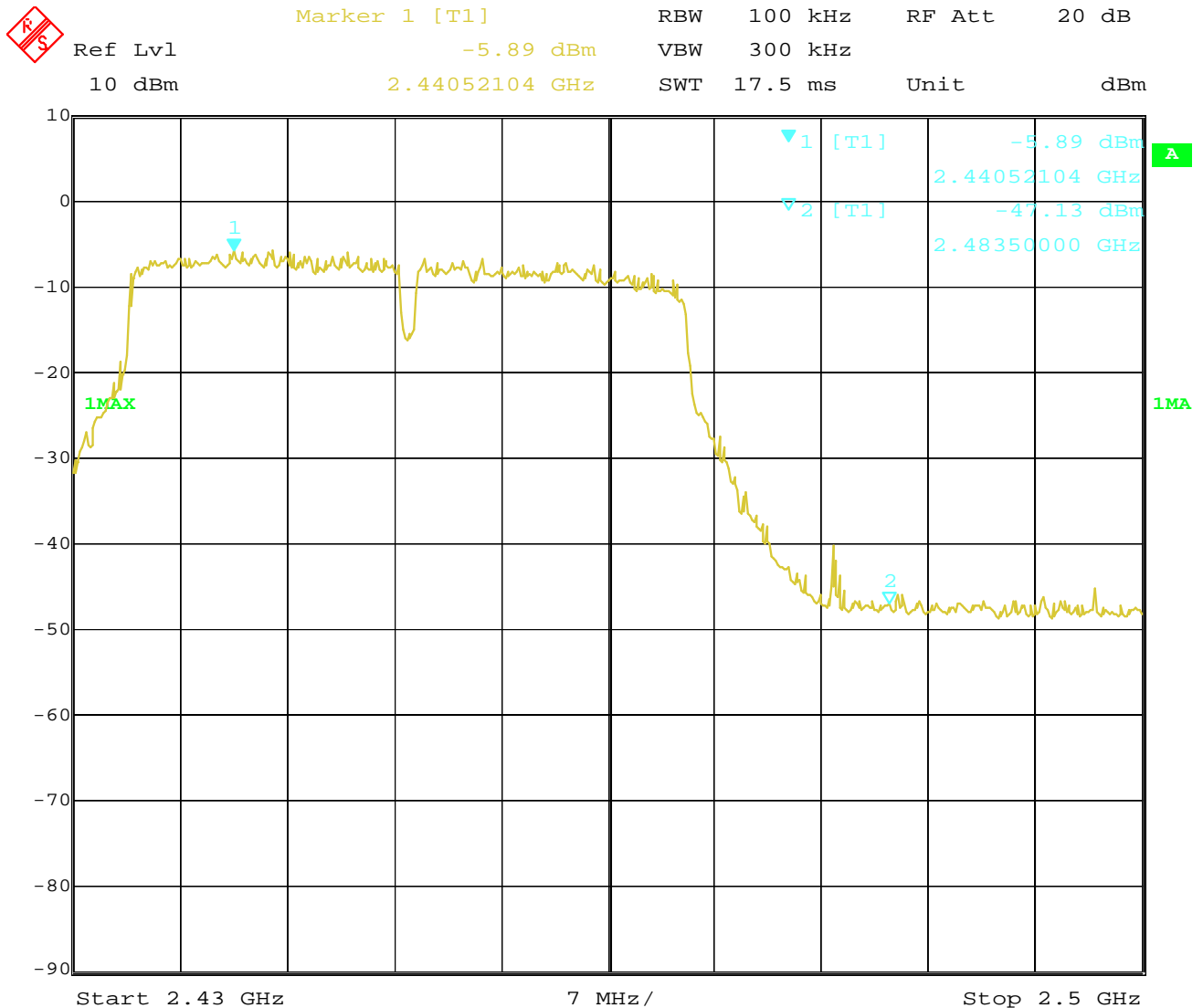

Date: 29.SEP.2021 14:59:38

The report refers only to the sample tested and does not apply to the bulk.  
 This report is issued in confidence to the client and it will be strictly treated as such by the SHENZHEN TIMEWAY TESTING LABORATORIES. It may not be reproduced rather in its entirety or in part and it may not be used for advertising. The client to whom the report is issued may, however, show or send it . or a certified copy there of prepared by the SHENZHEN TIMEWAY TESTING LABORATORIES. to his customer. Supplier or others persons directly concerned. SHENZHEN TIMEWAY TESTING LABORATORIES. will not, without the consent of the client enter into any discussion of correspondence with any third party concerning the contents of the report.  
 In the event of the improper use of the report. The SHENZHEN TIMEWAY TESTING LABORATORIES. reserves the rights to withdraw it and to adopt any other remedies which may be appropriate.



**10.5 Restricted band Measurement**

EUT	Wireless Remote Control Outlet		Model	RSN011R
Mode	Keeping Transmitting		Input Voltage	120V~
Temperature	24 deg. C,		Humidity	56% RH
Test Result:	Pass		Detector	PK
802.11b mode, Low Channel, Horizontal				
2390	PK (dB $\mu$ V/m)	55.12	Limit	74(dB $\mu$ V/m)
	AV (dB $\mu$ V/m)	37.86		54(dB $\mu$ V/m)
802.11b mode, Low Channel, Vertical				
2390	PK (dB $\mu$ V/m)	53.61	Limit	74(dB $\mu$ V/m)
	AV (dB $\mu$ V/m)	37.09		54(dB $\mu$ V/m)

**10.5 Restricted band Measurement**

EUT	Wireless Remote Control Outlet		Model	RSN011R
Mode	Keeping Transmitting		Input Voltage	120V~
Temperature	24 deg. C,		Humidity	56% RH
Test Result:	Pass		Detector	PK
802.11b mode, High Channel, Horizontal				
2483.5	PK (dB $\mu$ V/m)	57.82	Limit	74(dB $\mu$ V/m)
	AV (dB $\mu$ V/m)	40.13		54(dB $\mu$ V/m)
802.11b mode, High Channel, Vertical				
2483.5	PK (dB $\mu$ V/m)	55.63	Limit	74(dB $\mu$ V/m)
	AV (dB $\mu$ V/m)	38.76		54(dB $\mu$ V/m)

The report refers only to the sample tested and does not apply to the bulk.

This report is issued in confidence to the client and it will be strictly treated as such by the SHENZHEN TIMEWAY TESTING LABORATORIES. It may not be reproduced rather in its entirety or in part and it may not be used for advertising. The client to whom the report is issued may, however, show or send it . or a certified copy there of prepared by the SHENZHEN TIMEWAY TESTING LABORATORIES. to his customer. Supplier or others persons directly concerned. SHENZHEN TIMEWAY TESTING LABORATORIES. will not, without the consent of the client enter into any discussion of correspondence with any third party concerning the contents of the report. In the event of the improper use of the report. The SHENZHEN TIMEWAY TESTING LABORATORIES. reserves the rights to withdraw it and to adopt any other remedies which may be appropriate.



**10.5 Restricted band Measurement**

EUT	Wireless Remote Control Outlet		Model	RSN011R
Mode	Keeping Transmitting		Input Voltage	120V~
Temperature	24 deg. C,		Humidity	56% RH
Test Result:	Pass		Detector	PK
802.11g mode, Low Channel, Horizontal				
2390	PK (dB $\mu$ V/m)	57.23	Limit	74(dB $\mu$ V/m)
	AV (dB $\mu$ V/m)	38.95		54(dB $\mu$ V/m)
802.11g mode, Low Channel, Vertical				
2390	PK (dB $\mu$ V/m)	55.36	Limit	74(dB $\mu$ V/m)
	AV (dB $\mu$ V/m)	38.15		54(dB $\mu$ V/m)

**10.5 Restricted band Measurement**

EUT	Wireless Remote Control Outlet		Model	RSN011R
Mode	Keeping Transmitting		Input Voltage	120V~
Temperature	24 deg. C,		Humidity	56% RH
Test Result:	Pass		Detector	PK
802.11g mode, High Channel, Horizontal				
2483.5	PK (dB $\mu$ V/m)	60.56	Limit	74(dB $\mu$ V/m)
	AV (dB $\mu$ V/m)	43.07		54(dB $\mu$ V/m)
802.11g mode, High Channel, Vertical				
2483.5	PK (dB $\mu$ V/m)	57.82	Limit	74(dB $\mu$ V/m)
	AV (dB $\mu$ V/m)	40.50		54(dB $\mu$ V/m)

The report refers only to the sample tested and does not apply to the bulk.

This report is issued in confidence to the client and it will be strictly treated as such by the SHENZHEN TIMEWAY TESTING LABORATORIES. It may not be reproduced rather in its entirety or in part and it may not be used for advertising. The client to whom the report is issued may, however, show or send it . or a certified copy there of prepared by the SHENZHEN TIMEWAY TESTING LABORATORIES. to his customer. Supplier or others persons directly concerned. SHENZHEN TIMEWAY TESTING LABORATORIES. will not, without the consent of the client enter into any discussion of correspondence with any third party concerning the contents of the report. In the event of the improper use of the report. The SHENZHEN TIMEWAY TESTING LABORATORIES. reserves the rights to withdraw it and to adopt any other remedies which may be appropriate.



**10.5 Restricted band Measurement**

EUT	Wireless Remote Control Outlet		Model	RSN011R
Mode	Keeping Transmitting		Input Voltage	120V~
Temperature	24 deg. C,		Humidity	56% RH
Test Result:	Pass		Detector	PK
802.11n HT20 mode, Low Channel, Horizontal				
2390	PK (dB $\mu$ V/m)	57.12	Limit	74(dB $\mu$ V/m)
	AV (dB $\mu$ V/m)	38.83		54(dB $\mu$ V/m)
802.11n HT20 mode, Low Channel, Vertical				
2390	PK (dB $\mu$ V/m)	54.12	Limit	74(dB $\mu$ V/m)
	AV (dB $\mu$ V/m)	37.96		54(dB $\mu$ V/m)

**10.5 Restricted band Measurement**

EUT	Wireless Remote Control Outlet		Model	RSN011R
Mode	Keeping Transmitting		Input Voltage	120V~
Temperature	24 deg. C,		Humidity	56% RH
Test Result:	Pass		Detector	PK
802.11n HT20 mode, High Channel, Horizontal				
2483.5	PK (dB $\mu$ V/m)	59.85	Limit	74(dB $\mu$ V/m)
	AV (dB $\mu$ V/m)	43.07		54(dB $\mu$ V/m)
802.11n HT20 mode, High Channel, Vertical				
2483.5	PK (dB $\mu$ V/m)	57.18	Limit	74(dB $\mu$ V/m)
	AV (dB $\mu$ V/m)	38.92		54(dB $\mu$ V/m)

The report refers only to the sample tested and does not apply to the bulk.

This report is issued in confidence to the client and it will be strictly treated as such by the SHENZHEN TIMEWAY TESTING LABORATORIES. It may not be reproduced rather in its entirety or in part and it may not be used for advertising. The client to whom the report is issued may, however, show or send it . or a certified copy there of prepared by the SHENZHEN TIMEWAY TESTING LABORATORIES. to his customer. Supplier or others persons directly concerned. SHENZHEN TIMEWAY TESTING LABORATORIES. will not, without the consent of the client enter into any discussion of correspondence with any third party concerning the contents of the report. In the event of the improper use of the report. The SHENZHEN TIMEWAY TESTING LABORATORIES. reserves the rights to withdraw it and to adopt any other remedies which may be appropriate.



**10.5 Restricted band Measurement**

EUT	Wireless Remote Control Outlet		Model	RSN011R
Mode	Keeping Transmitting		Input Voltage	120V~
Temperature	24 deg. C,		Humidity	56% RH
Test Result:	Pass		Detector	PK
802.11n HT40 mode, Low Channel, Horizontal				
2390	PK (dB $\mu$ V/m)	61.35	Limit	74(dB $\mu$ V/m)
	AV (dB $\mu$ V/m)	43.71		54(dB $\mu$ V/m)
802.11n HT40 mode, Low Channel, Vertical				
2390	PK (dB $\mu$ V/m)	59.67	Limit	74(dB $\mu$ V/m)
	AV (dB $\mu$ V/m)	41.56		54(dB $\mu$ V/m)

**10.5 Restricted band Measurement**

EUT	Wireless Remote Control Outlet		Model	RSN011R
Mode	Keeping Transmitting		Input Voltage	120V~
Temperature	24 deg. C,		Humidity	56% RH
Test Result:	Pass		Detector	PK
802.11n HT40 mode, High Channel, Horizontal				
2483.5	PK (dB $\mu$ V/m)	63.21	Limit	74(dB $\mu$ V/m)
	AV (dB $\mu$ V/m)	45.19		54(dB $\mu$ V/m)
802.11n HT40 mode, High Channel, Vertical				
2483.5	PK (dB $\mu$ V/m)	59.60	Limit	74(dB $\mu$ V/m)
	AV (dB $\mu$ V/m)	46.43		54(dB $\mu$ V/m)

The report refers only to the sample tested and does not apply to the bulk.

This report is issued in confidence to the client and it will be strictly treated as such by the SHENZHEN TIMEWAY TESTING LABORATORIES. It may not be reproduced rather in its entirety or in part and it may not be used for advertising. The client to whom the report is issued may, however, show or send it . or a certified copy there of prepared by the SHENZHEN TIMEWAY TESTING LABORATORIES. to his customer. Supplier or others persons directly concerned. SHENZHEN TIMEWAY TESTING LABORATORIES. will not, without the consent of the client enter into any discussion of correspondence with any third party concerning the contents of the report. In the event of the improper use of the report. The SHENZHEN TIMEWAY TESTING LABORATORIES. reserves the rights to withdraw it and to adopt any other remedies which may be appropriate.



## **11.0 Antenna Requirement**

### **11.1 Standard Applicable**

For intentional device, according to FCC 47 CFR Section 15.203, an intentional radiator shall be designed to ensure that no antenna other than that furnished by the responsible party shall be used with the device.

And according to FCC 47 CFR Section 15.247 (b), if transmitter antennas of directional gain greater than 6 dBi are used, the power shall be reduced by the amount in dB that the directional gain of the antenna exceeds 6 dBi.

### **11.2 Antenna Connected construction**

PCB antennas used. The gain of the antenna is 1.0dBi.

The report refers only to the sample tested and does not apply to the bulk.

This report is issued in confidence to the client and it will be strictly treated as such by the SHENZHEN TIMEWAY TESTING LABORATORIES. It may not be reproduced either in its entirety or in part and it may not be used for advertising. The client to whom the report is issued may, however, show or send it or a certified copy thereof prepared by the SHENZHEN TIMEWAY TESTING LABORATORIES to his customer. Supplier or other persons directly concerned. SHENZHEN TIMEWAY TESTING LABORATORIES will not, without the consent of the client enter into any discussion of correspondence with any third party concerning the contents of the report.

In the event of the improper use of the report. The SHENZHEN TIMEWAY TESTING LABORATORIES reserves the rights to withdraw it and to adopt any other remedies which may be appropriate.





## 12.0 FCC ID Label

FCC ID: 2A2XV-N1121

The label must not be a stick-on paper label. The label on these products must be permanently affixed to the product and readily visible at the time of purchase and must last the expected lifetime of the equipment not be readily detachable.

### Mark Location:



The report refers only to the sample tested and does not apply to the bulk.

This report is issued in confidence to the client and it will be strictly treated as such by the SHENZHEN TIMEWAY TESTING LABORATORIES. It may not be reproduced rather in its entirety or in part and it may not be used for advertising. The client to whom the report is issued may, however, show or send it or a certified copy thereof prepared by the SHENZHEN TIMEWAY TESTING LABORATORIES to his customer. Supplier or others persons directly concerned. SHENZHEN TIMEWAY TESTING LABORATORIES will not, without the consent of the client enter into any discussion of correspondence with any third party concerning the contents of the report.

In the event of the improper use of the report. The SHENZHEN TIMEWAY TESTING LABORATORIES reserves the rights to withdraw it and to adopt any other remedies which may be appropriate.



### 13.0 Photo of testing

Conducted Emission Test Setup:

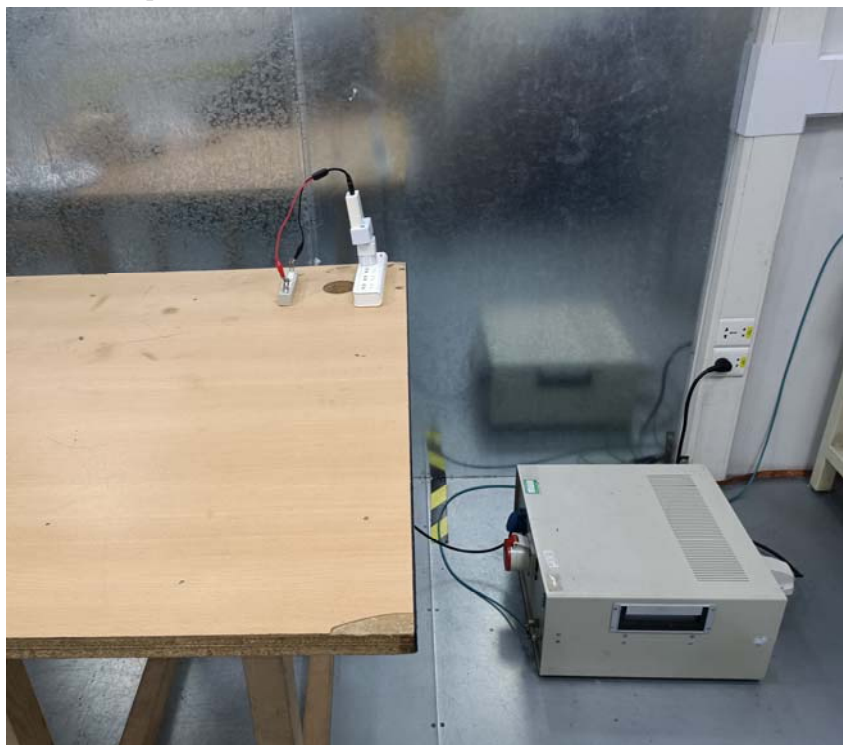

The report refers only to the sample tested and does not apply to the bulk.

This report is issued in confidence to the client and it will be strictly treated as such by the SHENZHEN TIMEWAY TESTING LABORATORIES. It may not be reproduced rather in its entirety or in part and it may not be used for advertising. The client to whom the report is issued may, however, show or send it or a certified copy thereof prepared by the SHENZHEN TIMEWAY TESTING LABORATORIES to his customer. Supplier or others persons directly concerned. SHENZHEN TIMEWAY TESTING LABORATORIES will not, without the consent of the client enter into any discussion of correspondence with any third party concerning the contents of the report.

In the event of the improper use of the report. The SHENZHEN TIMEWAY TESTING LABORATORIES reserves the rights to withdraw it and to adopt any other remedies which may be appropriate.



Radiated Emission Test Setup:

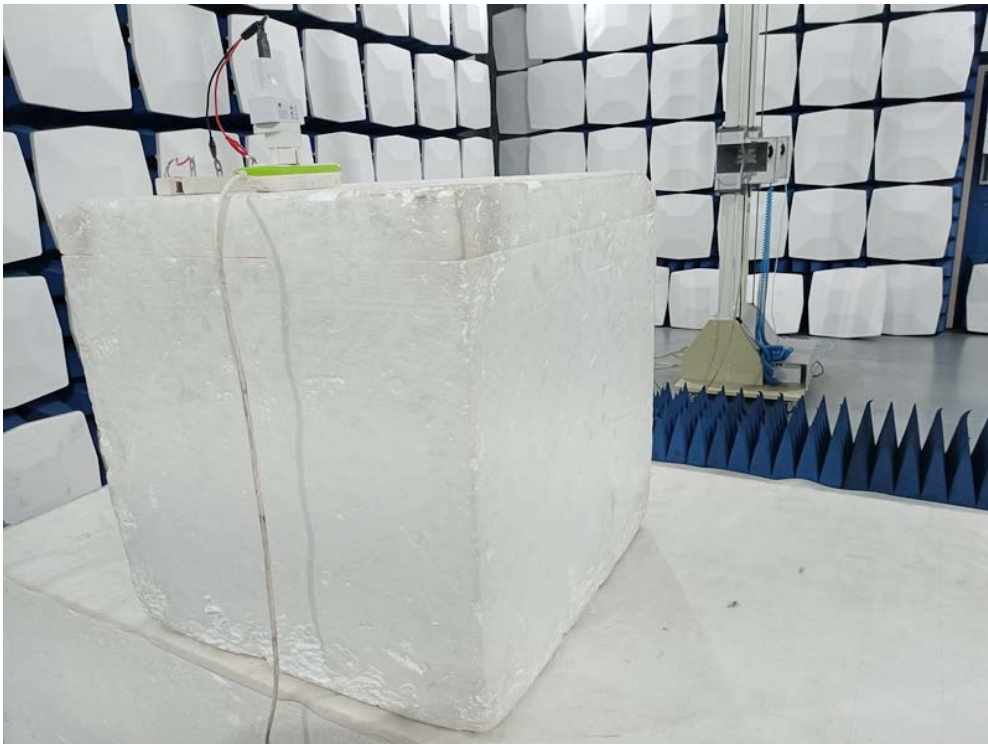

The report refers only to the sample tested and does not apply to the bulk.

This report is issued in confidence to the client and it will be strictly treated as such by the SHENZHEN TIMEWAY TESTING LABORATORIES. It may not be reproduced rather in its entirety or in part and it may not be used for advertising. The client to whom the report is issued may, however, show or send it, or a certified copy thereof prepared by the SHENZHEN TIMEWAY TESTING LABORATORIES, to his customer. Supplier or others persons directly concerned. SHENZHEN TIMEWAY TESTING LABORATORIES, will not, without the consent of the client enter into any discussion of correspondence with any third party concerning the contents of the report. In the event of the improper use of the report. The SHENZHEN TIMEWAY TESTING LABORATORIES, reserves the rights to withdraw it and to adopt any other remedies which may be appropriate.

### Photographs – EUT

Outside View

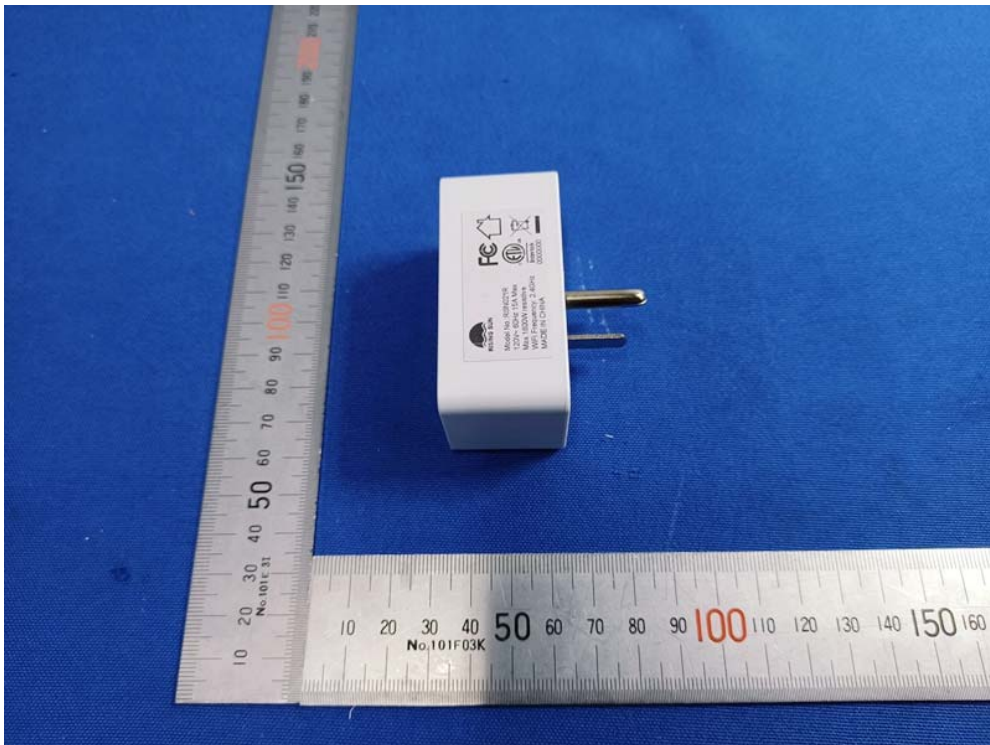

The report refers only to the sample tested and does not apply to the bulk.

This report is issued in confidence to the client and it will be strictly treated as such by the SHENZHEN TIMEWAY TESTING LABORATORIES. It may not be reproduced rather in its entirety or in part and it may not be used for advertising. The client to whom the report is issued may, however, show or send it to a certified copy thereof prepared by the SHENZHEN TIMEWAY TESTING LABORATORIES to his customer. Supplier or others persons directly concerned. SHENZHEN TIMEWAY TESTING LABORATORIES will not, without the consent of the client enter into any discussion of correspondence with any third party concerning the contents of the report.

In the event of the improper use of the report. The SHENZHEN TIMEWAY TESTING LABORATORIES reserves the rights to withdraw it and to adopt any other remedies which may be appropriate.



Outside View



The report refers only to the sample tested and does not apply to the bulk.

This report is issued in confidence to the client and it will be strictly treated as such by the SHENZHEN TIMEWAY TESTING LABORATORIES. It may not be reproduced in its entirety or in part and it may not be used for advertising. The client to whom the report is issued may, however, show or send it to a certified copy thereof prepared by the SHENZHEN TIMEWAY TESTING LABORATORIES to his customer. Supplier or others persons directly concerned. SHENZHEN TIMEWAY TESTING LABORATORIES will not, without the consent of the client enter into any discussion of correspondence with any third party concerning the contents of the report. In the event of the improper use of the report. The SHENZHEN TIMEWAY TESTING LABORATORIES reserves the rights to withdraw it and to adopt any other remedies which may be appropriate.



Outside View



The report refers only to the sample tested and does not apply to the bulk.

This report is issued in confidence to the client and it will be strictly treated as such by the SHENZHEN TIMEWAY TESTING LABORATORIES. It may not be reproduced rather in its entirety or in part and it may not be used for advertising. The client to whom the report is issued may, however, show or send it or a certified copy thereof prepared by the SHENZHEN TIMEWAY TESTING LABORATORIES to his customer. Supplier or others persons directly concerned. SHENZHEN TIMEWAY TESTING LABORATORIES will not, without the consent of the client enter into any discussion of correspondence with any third party concerning the contents of the report. In the event of the improper use of the report. The SHENZHEN TIMEWAY TESTING LABORATORIES reserves the rights to withdraw it and to adopt any other remedies which may be appropriate.

Inside view

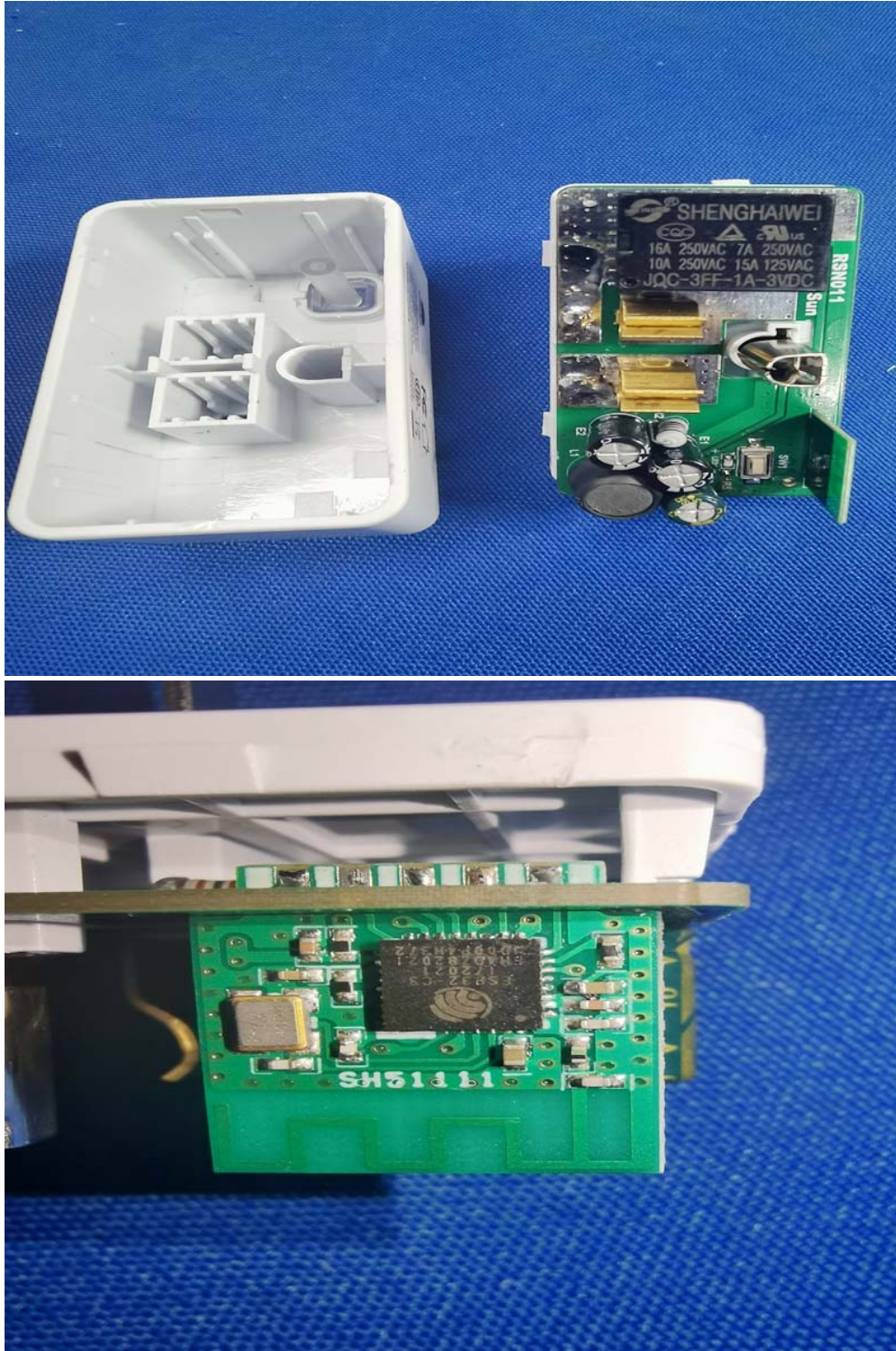

The report refers only to the sample tested and does not apply to the bulk.

This report is issued in confidence to the client and it will be strictly treated as such by the SHENZHEN TIMEWAY TESTING LABORATORIES. It may not be reproduced rather in its entirety or in part and it may not be used for advertising. The client to whom the report is issued may, however, show or send it, or a certified copy thereof prepared by the SHENZHEN TIMEWAY TESTING LABORATORIES, to his customer. Supplier or others persons directly concerned. SHENZHEN TIMEWAY TESTING LABORATORIES, will not, without the consent of the client enter into any discussion of correspondence with any third party concerning the contents of the report. In the event of the improper use of the report. The SHENZHEN TIMEWAY TESTING LABORATORIES, reserves the rights to withdraw it and to adopt any other remedies which may be appropriate.



Inside view

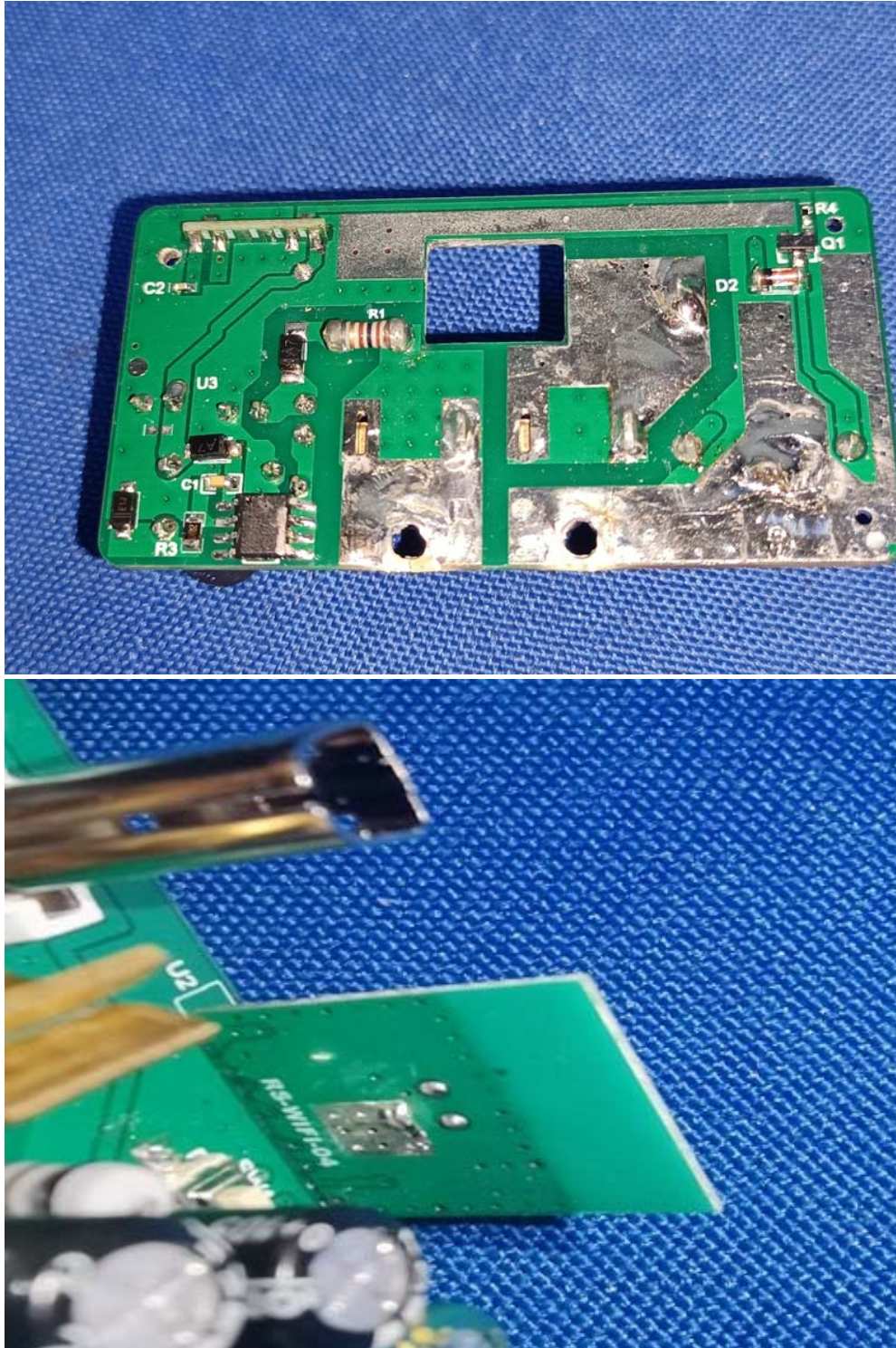

End of the report

The report refers only to the sample tested and does not apply to the bulk.

This report is issued in confidence to the client and it will be strictly treated as such by the SHENZHEN TIMEWAY TESTING LABORATORIES. It may not be reproduced rather in its entirety or in part and it may not be used for advertising. The client to whom the report is issued may, however, show or send it . or a certified copy there of prepared by the SHENZHEN TIMEWAY TESTING LABORATORIES. to his customer. Supplier or others persons directly concerned. SHENZHEN TIMEWAY TESTING LABORATORIES. will not, without the consent of the client enter into any discussion of correspondence with any third party concerning the contents of the report. In the event of the improper use of the report. The SHENZHEN TIMEWAY TESTING LABORATORIES. reserves the rights to withdraw it and to adopt any other remedies which may be appropriate.