

**E202**  
(Tuya WiFi)

## Smart Lock User Manual

Please read this manual carefully before use

Please keep the emergency key with you or put it in outdoor safe place.

V2.3

## Information & Safety Warnings

Note: Please prepare a Phillips screwdriver and 4 AA batteries before installation.

1. Keep your fingers clean before using this product.
2. In original settings, it can be unlocked with any fingerprint, any card, or password `1234567890` ended with `#`.
3. Unlock: Press registered fingerprint on front handle sensor, or make card close to the lock pad, or enter password ended with `#`.
4. If the power is insufficient, there will be an alarm prompt, and the lock can only be unlocked around 50 times, please replace with 4 new batteries in time. When batteries power running out, connecting a power bank with Micro USB wire through Emergency Power Port can unlock, but the APP network function will be failure.
5. When the password/fingerprint/card/APP can not unlock the door, please use the key to unlock the door. Please keep the emergency key with you or put it in outdoor safe place.
6. Waking up lock needs around 3 seconds or more, when long time no use.
7. After the indoor back locking paddle is locked, the front and back handles cannot be rotated to open the door. please don't forcefully rotate the front or back handles to avoid damage to the internal structure of the lock body.
8. Door thickness: 35mm ~ 80mm.
9. Work temperature range: -25°C ~ 55°C.

## Features

1. The total capacity of system is 100, and the first three are administrator.
2. Touching button, durable.
3. Support 6-8 password and 20 virtual passwords.
4. Support low power warning, volume adjustment and doorbell.
5. Support pickproof alarm.

Name	Parameter
Fingerprint Sensor	semiconductor
DPI	500
Identify Time	0.3S
Unlock Way	Fingerprint, Card, Password, Key and APP
System Capacity	100(The fingerprint maximum capacity is 50)
Supply Voltage	6V
Low Voltage Warning	4.8V
Standby Current	<90uA

## Installation

### 1. Installation Instructions

- a. It is recommended to look for professionals to install, watch the video carefully before installation.
- b. While installing, the door must be in half-open state until the installation and debug is completed.
- c. Before the installation, the lock must be selected correctly according to the door opening direction.
- d. When installing the back panel, please see from the screw hole and make the connection wire is not blocking the connection column hole to avoid damaging the connection wire when installing the screw. If the connection wire blocks the connection column hole, please re-position the connection wire or expand door internal hole to allow for enough space to place the connection wire.
- e. After the installation is completed, test with fingerprint, with card, with password(1234567890#), with APP, with key to unlock, and test whether the front handle and back handle unlock/lock normally or not.
- f. If it does not work properly, please check if there is improper installation or if the power cord is loose.

## 2. Installation Overview

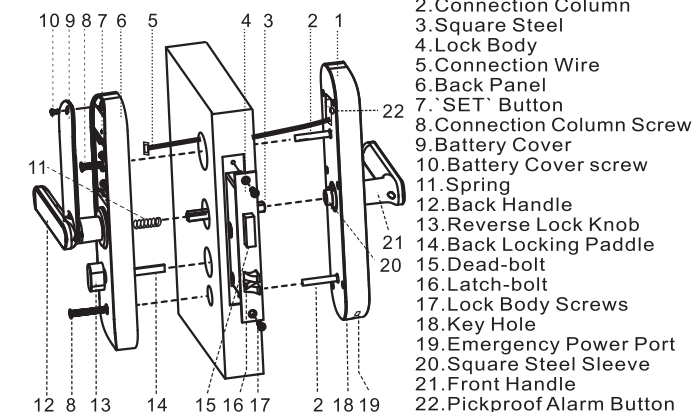

1. Front Panel
2. Connection Column
3. Square Steel
4. Lock Body
5. Connection Wire
6. Back Panel
7. `SET` Button
8. Connection Column Screw
9. Battery Cover
10. Battery Cover screw
11. Spring
12. Back Handle
13. Reverse Lock Knob
14. Back Locking Paddle
15. Dead-bolt
16. Latch-bolt
17. Lock Body Screws
18. Key Hole
19. Emergency Power Port
20. Square Steel Sleeve
21. Front Handle
22. Pickproof Alarm Button

## 3. Confirm The Direction of The Door

This smart lock is suitable for 4 kinds of opening directions.  
(Left Out/Left In/Right Out/Right In)

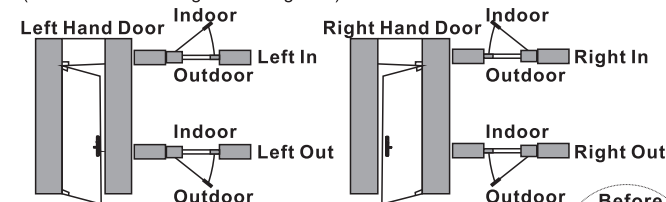

## 4. Handle Direction Change

- 4.1 Check if the handle direction is appropriate for the door, if not, please change the handle direction.
- 4.2 Front Handle Direction Change  
Disassemble the direction-changing screw, carefully and slowly twist the handle clockwise 180 degrees, then fix the direction-changing screw. Twist the handle to check, make sure it's not stuck.
- 4.3 Back Handle Direction Change  
Similar operation as front handle direction change.
- 4.4 Match the front handle and back handle to make sure they have the right direction.

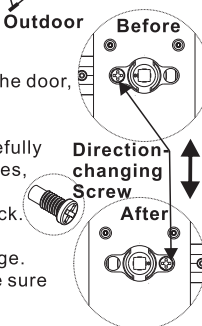

## 5. Open Hole

Please refer to the open hole drawing, and drill right holes on the door.

## 6. Install Lock Body

- 6.1. Choose the installation direction of the latch-bolt of the lock body by the door opening directions.



- 6.2. Change the direction of lock body
  - a. Push the reversing block to the other side.
  - b. Push the latch-bolt into the lock and turn 180 degrees.
  - c. Put back the reversing block, and the latch-bolt will pop up automatically.
- 6.3. Put the lock body into the door frame and tighten 2 fixing screws.

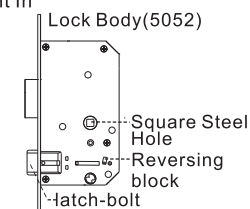

**Note: Please don't forcefully unlock by heavily pressing down the lock handles when reverse lock knob set.**

## 7. Choose The Parts

Choose suitable parts according to the following table.

Door thickness	Square Steel Length	Connection Column Length	Connection Column Screw Length
35-51mm	80mm	35mm	30mm+50mm
52-62mm	80mm	35mm	50mm+70mm
63-80mm	100mm	55mm	50mm+70mm
>80mm(Optional)	120mm	55mm	70mm+90mm

**Note:** If the door thickness is 35-36mm, the spring in the square steel hole of the back panel need to cut half or take out.

## 8. Install The Lock

### 8.1. Install The Front Panel

- Install 2 connection columns on the front panel.
- Adjust the dot direction on square steel sleeve with reference to the sticker on the rubber mat.

\* Left open(Keep the dot in the left or in the right)

\* Right open(Keep the dot in the top or at the bottom)

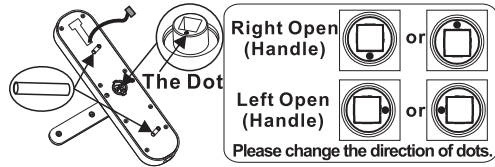

- Insert the suitable square steel into the lock body.
- Pass the connection wire through the door hole.
- Align the square steel with the square steel hole of the front panel and fix the front panel on the door, then press the other end of the square steel.

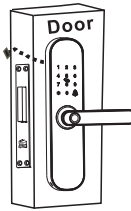

### 8.2. Install The Back Panel

- Press the front panel, and connect the connection wire with the corresponding interface of the back panel, then insert the excess wire into the door hole.
- Insert back locking paddle into the lock body, and you can cut off one or two sections of back locking paddle according to the thickness of the door.

**Note:** The length of back locking paddle does not exceed the thickness of the door.

- Align the square steel with the square steel hole of the back panel, and compress the back panel.
- Lock 2 connection column screws to fix the back panel.
- Install 4 AA batteries and the battery cover, then lock the battery cover screw.

**Note:** When installing the back lock, please see from the screw hole and make the connection wire not block the connection column hole to avoid damage connection wire when installing the screw.

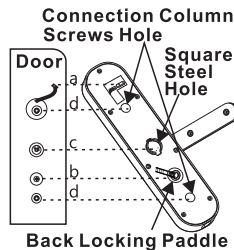

## 9. Install Buckle Plate And Buckle Box

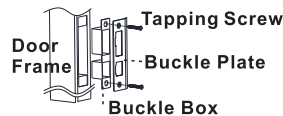

## 10. Debugging

- Please always keep the door in half-open status when debugging.
- Check the following function can be achieved or not.
  - \* Press down front handle, latch-bolt/dead-bolt remains in locking status.
  - \* Press down front handle, latch-bolt/dead-bolt retract in unlocking status.
  - \* Lift up front handle, dead-bolt stretches out in any status.
  - \* Press down back handle, latch-bolt/dead-bolt retract in any status.
  - \* Lift up back handle, dead-bolt stretches out in any status.
- When reverse locking from inside, press down front handle/ back handle, latch-bolt/dead-bolt remains.
- Verify other function normally or not, including self-locking, virtual password, setting button, APP etc.

## Using The Lock

**Add The Administrator** (The first three are administrator)

- Long press `\*\*`, the voice prompt: `please enter 6-8 digits admin password followed by `#`.
- Add administrator's password (6-8 numbers) ended with `#` (the same password, 2 times), the voice prompt: `add successfully`.
- Then you can continue to add fingerprint(6 times), card, password(6-8 numbers) ended with `#` (the same password, 2 times).

**Notes:**

- `\*`: Back, Sign out button, `#`: Confirm button.
- Make sure to press different parts of the same finger until the whole finger is collected completely, the lock keypad 1-6 digits will be light on when add successful. The improper operation will increase the input times.



**Add The User**

- Long press `\*\*`, the voice prompt: `Please verify the administrator`.
- Verify the administrator.
- Add user's fingerprint(6 times), card, or password (6-8 numbers) ended with `#` (the same password, 2 times).
- The voice prompt: `add successfully`, then you can continue to add.

**Delete The User**

- Long press `\*\*`, the voice prompt: `Please verify the administrator`.
- Verify the administrator and long press `\*\*` again.
- Press `1` to remove all user fingerprints, press `2` to remove all user passwords, press `3` to remove all user cards, press `4` to remove all users.
- The voice prompt: `successful`.

**Note:** The administrator can't be removed by doing this or by APP.

**Modify Password**

- Press `7`#`, the lock will long beep, then enter the old password which needs to be modified, the voice prompt `Please add user`.
- Enter new password ended by `#` (the same password, 2 times), the voice prompt `successful`.

**Note:** The old password that was modified will be invalid after modification.

**APP Installation And Network Configuration**

- Search `Tuya smart` in APP store, download APP.
- Install and open APP, register and login with the mobile phone number.
- APP: Press `Home`/`Add Device`/`Security&Sensor`/`Lock(Wi-Fi)`/`Confirm indicator rapidly blink`, then select WiFi network, enter WiFi password.
- Lock: Short press `3`#`, Verify the administrator, the LED of `8` fast flash.
- APP: Refer to the operation prompt to complete the network configuration.
- Add successfully: The voice prompt `add successfully`.
- Add failure: LED light show `X` and the voice prompts `add failure` ,please try again.

**Notes:**

- This APP supports only 2.4Ghz WiFi network.
- The WiFi connected to the APP and mobile phone should be stay in same.
- Make sure one of the administrators is a password.
- APP Remote Unlock:
  - Lock: Press `4`#` to activate the lock.
  - APP: When prompting `Remote Unlock Request`, slide icon to `Agree`.
- Users: You can add the fingerprint/password/card according to the prompt.
- Temporary Code:
  - Click `Temporary Code`, you can set online code or offline code to unlock.

## Reset The Lock

- Remove the battery cover, long-press `Set` for 3 seconds, verify the administrator.
- The system restores to the factory default settings.

**Notes:**

- After the reset, all user and administrator information are removed.
- The password will return to its default `1234567890`.
- Please add a new administrator immediately.

## Self-locking

If the password is entered wrong for 5 times continuously, the system will be locked for 180 seconds, and the fingerprint or card unlock can remove self-locking. If the fingerprint is entered wrong for 5 times continuously, the system will be locked for 180 seconds, and the card unlock can remove self-locking.

## Low Power Warning

When the battery power is lower than 4.8V, the lock will prompt `The battery is use up, please replace it`, please replace with 4 new batteries in time.

## Virtual Password

Enter the virtual password before or after the real password, it can be unlocked.

**Volume Adjustment:** Press `3`#` to switch(Mute, Low, Medium, High).

**Door Bell:** Press `#` in the standby or initial state.

## Pickproof Alarm

When the front lock is damaged by external forces, the pickproof alarm button is loose, the lock will alert alarm, report the APP notification.

**Remove The Pickproof Alarm:** Unlock by the registered user (Including administrators), or remove the battery and reinstall.

## FCC Statement:

This device complies with Part 15 of the FCC Rules. Operation is subject to the following two conditions:

- (1) This device may not cause harmful interference.
- (2) This device must accept any interference received, including interference that may cause undesired operation.

Warning: Changes or modifications not expressly approved by the party responsible for compliance could void the user's authority to operate the equipment.

Note: This equipment has been tested and found to comply with the limits for a Class B digital device, pursuant to Part 15 of the FCC Rules. These limits are designed to provide reasonable protection against harmful interference in a residential installation. This equipment generates uses and can radiate radio frequency energy and, if not installed and used in accordance with the instructions, may cause harmful interference to radio communications. However, there is no guarantee that interference will not occur in a particular installation. If this equipment does cause harmful interference to radio or television reception, which can be determined by turning the equipment off and on, the user is encouraged to try to correct the interference by one or more of the following measures:

- Reorient or relocate the receiving antenna.
- Increase the separation between the equipment and receiver.
- Connect the equipment into an outlet on a circuit different from that to which the receiver is connected.
- Consult the dealer or an experienced radio/TV technician for help.

## FCC Radiation Exposure Statement:

This equipment complies with FCC radiation exposure limits set forth for an uncontrolled environment. This equipment should be installed and operated with minimum distance 20cm between the radiator your body.



APP Download QR Code