



RF TEST REPORT

Product Name: Suck-O-Mat 3.0

Model Name: 5401380

FCC ID: 2A2W8-5401380

Issued For : ORION Versand GmbH & Co. KG

Schaeferweg 14 Flensburg, 24941 Germany

Issued By : Shenzhen LGT Test Service Co., Ltd.

Room 205, Building 13, Zone B, Zhenxiong Industrial Park,
No.177, Renmin West Road, Jinsha, Kengzi Street, Pingshan
District, Shenzhen, Guangdong, China

Report Number: LGT24A182RF02

Sample Received Date: Feb. 26, 2024

Date of Test: Feb. 26, 2024 – Apr. 23, 2024

Date of Issue: Apr. 23, 2024

The test report is effective only with both signature and specialized stamp. This report shall not be reproduced except in full without the written approval of the Laboratory. The results in this report only apply to the tested sample.



TEST REPORT CERTIFICATION

Applicant: ORION Versand GmbH & Co. KG
Address: Schaeferweg 14 Flensburg, 24941 Germany

Manufacture: GENLUX ELECTRICAL PRODUCTS LTD
Address: 2nd Floor, No. 190 Dongfeng Road, Qingxi Town, Dongguan City, Guangdong Province

Product Name: Suck-O-Mat 3.0

Trademark: N/A

Model Name: 5401380

Sample Status: Normal

| APPLICABLE STANDARDS | |
|--|--------------|
| STANDARD | TEST RESULTS |
| FCC Part 15.231, Subpart C ANSI C63.10-2013 | PASS |

Prepared by:

Zane Shan

Zane Shan
Engineer

Approved by:

Vita Li

Vita Li
Technical Director





TABLE OF CONTENTS

Page

| | |
|--|-----------|
| 1. SUMMARY OF TEST RESULTS | 6 |
| 1.1 TEST FACTORY | 7 |
| 1.2 MEASUREMENT UNCERTAINTY | 7 |
| 2. GENERAL INFORMATION | 8 |
| 2.1 GENERAL DESCRIPTION OF THE EUT | 8 |
| 2.2 DESCRIPTION OF THE TEST MODES | 9 |
| 2.3 DESCRIPTION OF NECESSARY ACCESSORIES AND SUPPORT UNITS | 9 |
| 2.4 EQUIPMENTS LIST | 10 |
| 3. EMC EMISSION TEST | 11 |
| 3.1 CONDUCTED EMISSION MEASUREMENT | 11 |
| 3.2 TEST PROCEDURE | 12 |
| 3.3 TEST SETUP | 12 |
| 3.4 TEST RESULTS | 13 |
| 4. RADIATED EMISSION MEASUREMENT | 15 |
| 4.1 RADIATED EMISSION LIMITS | 15 |
| 4.2 TEST PROCEDURE | 17 |
| 4.3 DEVIATION FROM TEST STANDARD | 17 |
| 4.4 TEST SETUP | 18 |
| 4.5 EUT OPERATING CONDITIONS | 19 |
| 4.6 TEST RESULTS | 19 |
| 4.7 FIELD STRENGTH CALCULATION | 20 |
| 5. BANDWIDTH TEST | 25 |
| 5.1 LIMIT | 25 |
| 5.2 TEST REQUIREMENTS | 25 |
| 5.3 TEST PROCEDURE | 25 |
| 5.4 TEST SETUP | 25 |
| 5.5 EUT OPERATION CONDITIONS | 25 |
| 5.6 TEST RESULTS | 26 |
| 6. DUTY CYCLE | 27 |
| 6.1 TEST PROCEDURE | 27 |
| 6.2 TEST SETUP | 27 |
| 6.3 EUT OPERATION CONDITIONS | 27 |
| 6.4 TEST RESULTS | 28 |
| 7. AUTOMATICALLY DEACTIVATE | 30 |



TABLE OF CONTENTS

| | Page |
|--|-----------|
| 7.1 STANDARD REQUIREMENT | 30 |
| 7.2 TEST PROCEDURE | 30 |
| 8. ANTENNA REQUIREMENT | 32 |
| 8.1 STANDARD REQUIREMENT | 32 |
| 8.2 EUT ANTENNA | 32 |
| APPENDIX I - PHOTOS OF TEST SETUP | 33 |



Revision History

| Rev. | Issue Date | Revisions |
|------|---------------|---------------|
| 00 | Apr. 23, 2024 | Initial Issue |
| | | |



1. SUMMARY OF TEST RESULTS

Test procedures according to the technical standards:

| FCC Part 15.231, Subpart C | | | |
|-----------------------------------|----------------------------|----------|--------|
| Standard Section | Test Item | Judgment | Remark |
| 15.207 | Conducted Emission | PASS | -- |
| 15.205(a)/15.209/ 15.231.(b) | Radiated Spurious Emission | PASS | -- |
| 15.231(a)(1)/ 15.231(b)(2) | Transmission requirement | PASS | -- |
| 15.231(C) | 20 dB Bandwidth | PASS | -- |
| 15.203 | Antenna Requirement | PASS | -- |

NOTE: (1) 'N/A' denotes test is not applicable in this Test Report.

(2) All tests are according to ANSI C63.10-2013.



1.1 TEST FACTORY

| | |
|---------------------------|--|
| Company Name: | Shenzhen LGT Test Service Co., Ltd. |
| Address: | Room 205, Building 13, Zone B, Zhenxiong Industrial Park, No.177, Renmin West Road, Jinsha, Kengzi Street, Pingshan District, Shenzhen, Guangdong, China |
| Accreditation Certificate | A2LA Certificate No.: 6727.01 |
| | FCC Registration No.: 746540 |
| | CAB ID: CN0136 |

1.2 MEASUREMENT UNCERTAINTY

The reported uncertainty of measurement $y \pm U$, where expanded uncertainty U is based on a standard uncertainty multiplied by a coverage factor of $k=2$, providing a level of confidence of approximately **95** %.

| Parameter | Uncertainty |
|---------------------------------------|---------------------|
| RF Output Power, Conducted | $\pm 0.71\text{dB}$ |
| Unwanted Emission, Conducted | $\pm 0.63\text{dB}$ |
| Conducted emission | $\pm 2.80\text{dB}$ |
| All Emissions, Radiated (0.009-30MHz) | $\pm 2.16\text{dB}$ |
| All Emissions, Radiated (30MHz-1GHz) | $\pm 4.40\text{dB}$ |
| All Emissions, Radiated (1GHz-18GHz) | $\pm 5.49\text{dB}$ |



2. GENERAL INFORMATION

2.1 GENERAL DESCRIPTION OF THE EUT

| | |
|-------------------------|---|
| Product Name | Suck-O-Mat 3.0 |
| Trademark | N/A |
| Model Name | 5401380 |
| Series Model | N/A |
| Model Difference | N/A |
| Frequency band | 433.94MHz |
| EUT Voltage | 5VDC (Charging), 3.7VDC (lithium battery) |
| Adapter | Input: AC 100-240V, 50/60Hz, 2.5A Output: DC 12.0V, 12.5A 150.0W |
| Modulation Type | ASK |
| Hardware version number | N/A |
| Software version number | N/A |
| Connecting I/O Port(s) | N/A |

Note:

1. For a more detailed features description, please refer to the manufacturer's specifications or the User Manual.



2.2 DESCRIPTION OF THE TEST MODES

To investigate the maximum EMI emission characteristics generated from EUT, the test system was pre-scanning tested based on the consideration of following EUT operation mode or test configuration mode which possibly have effect on EMI emission level. Each of these EUT operation mode(s) or test configuration mode(s) mentioned above was evaluated respectively.

| Pretest Mode | Description |
|--------------|-------------|
| Mode 1 | TX Mode |

| For Radiated Emission | |
|-----------------------|-------------|
| Final Test Mode | Description |
| Mode 1 | TX Mode |

2.3 DESCRIPTION OF NECESSARY ACCESSORIES AND SUPPORT UNITS

The EUT has been tested as an independent unit together with other necessary accessories or support units. The following support units or accessories were used to form a representative test configuration during the tests.

Accessories Equipment

| Description | Manufacturer | Model | S/N | Rating |
|------------------|--|-----------------|-----|---|
| Adapter | FUOSHAN SHUNDE GUANYUDA POWER SUPPLY CO., LTD | GM152-1201250-F | N/A | Input: 100-240V ~ 50/60Hz 2.5A Output: 12V, 12.5A |
| Power cord | N/A | N/A | N/A | 1.5m |
| Connecting Cable | N/A | N/A | N/A | 1.8m, with ferrite core |
| | | | | |

Auxiliary Equipment

| Description | Manufacturer | Model | S/N | Rating |
|-------------|--------------|-------|-----|--------|
| | | | | |
| | | | | |
| | | | | |
| | | | | |

Note:

(1) For detachable type I/O cable should be specified the length in cm in 『Length』 column.



2.4 EQUIPMENTS LIST

| RF Radiated Test equipment | | | | | |
|----------------------------|---------------------|-----------|--------------|------------|------------|
| Equipment | Manufacturer | Model No. | Serial No. | Cal. Date | Cal. Until |
| EMI Test Receiver | R&S | ESU8 | 100372 | 2023.04.13 | 2024.04.12 |
| | | | | 2024.03.09 | 2025.03.08 |
| Active loop Antenna | R&S | HFH2-Z2 | POS871398181 | 2022.06.02 | 2025.06.01 |
| Spectrum Analyzer | Keysight | N9020A | MY50530994 | 2023.10.12 | 2024.10.10 |
| Bilog Antenna | Schwarzbeck | VULB 9168 | 01447 | 2022.12.12 | 2025.12.11 |
| Horn Antenna | Schwarzbeck | 3115 | 10SL0060 | 2022.06.02 | 2024.06.01 |
| Pre-amplifier (9kHz-1GHz) | EMtrace | RP01A | 02017 | 2023.04.07 | 2024.04.06 |
| | | | | 2024.03.09 | 2025.03.08 |
| Pre-amplifier(1-26.5G) | Agilent | 8449B | 3008A4722 | 2023.04.07 | 2024.04.06 |
| | | | | 2024.03.09 | 2025.03.08 |
| RE Cable (9K-1G) | N.A | R01 | N.A | 2023.05.05 | 2024.05.04 |
| RE Cable (1-26G) | N.A | R02 | N.A | 2023.05.05 | 2024.05.04 |
| Temperature & Humidity | JINGCHUAN G | BT-3 | N.A | 2023.04.24 | 2024.04.23 |
| Testing Software | EMC-I_V1.4.0.3_SKET | | | | |

| RF Conducted Test equipment | | | | | |
|-------------------------------------|---------------------|------------|---------------|------------|------------|
| Equipment | Manufacturer | Model No. | Serial No. | Cal. Date | Cal. Until |
| Spectrum Analyzer | Kesight | N9010B | MY60242508 | 2023.08.14 | 2024.08.13 |
| RF Automatic Test system | MW | MW100-RFCB | MW220324LG-33 | 2023.04.10 | 2024.04.09 |
| | | | | 2024.03.09 | 2025.03.08 |
| Temperature & Humidity test chamber | AISRY | LX-1000L | 171200018 | 2023.05.10 | 2024.05.09 |
| Temperature & Humidity | JINGCHUANG | BT-3 | N.A | 2023.04.24 | 2024.04.23 |
| Testing Software | MTS8310_V2.0.0.0_MW | | | | |



3. EMC EMISSION TEST

3.1 CONDUCTED EMISSION MEASUREMENT

3.1.1 POWER LINE CONDUCTED EMISSION LIMITS

The radio frequency voltage that is conducted back onto the AC power line on any frequency or frequencies, within the band 150 kHz to 30 MHz, shall not exceed the limits in the following table.

| FREQUENCY (MHz) | Class B (dBuV) | | Standard |
|-----------------|----------------|-----------|----------|
| | Quasi-peak | Average | |
| 0.15 -0.5 | 66 - 56 * | 56 - 46 * | CISPR |
| 0.50 -5.0 | 56.00 | 46.00 | CISPR |
| 5.0 -30.0 | 60.00 | 50.00 | CISPR |
| | | | |
| 0.15 -0.5 | 66 - 56 * | 56 - 46 * | FCC |
| 0.50 -5.0 | 56.00 | 46.00 | FCC |
| 5.0 -30.0 | 60.00 | 50.00 | FCC |

Note:

(1) The tighter limit applies at the band edges.

(2) The limit of “ * ” marked band means the limitation decreases linearly with the logarithm of the frequency in the range.

The following table is the setting of the receiver

| Receiver Parameters | Setting |
|---------------------|----------|
| Attenuation | 10 dB |
| Start Frequency | 0.15 MHz |
| Stop Frequency | 30 MHz |
| IF Bandwidth | 9 kHz |



3.2 TEST PROCEDURE

- a. The EUT is 0.8 m from the horizontal ground plane and 0.4 m from the vertical ground plane with EUT being connected to the power mains through a line impedance stabilization network (LISN). All other support equipments are powered from additional LISN(s). The LISN provides 50 Ohm/ 50uH of coupling impedance for the measuring instrument.
- b. Interconnecting cables that hang closer than 40 cm to the ground plane shall be folded back and forth in the center forming a bundle 30 to 40 cm long.
- c. I/O cables that are not connected to a peripheral shall be bundled in the center. The end of the cable may be terminated, if required, using the correct terminating impedance. The overall length shall not exceed 1 m.
- d. LISN at least 80 cm from nearest part of EUT chassis.
- e. For the actual test configuration, please refer to the related Item –EUT Test Photos.

3.3 TEST SETUP

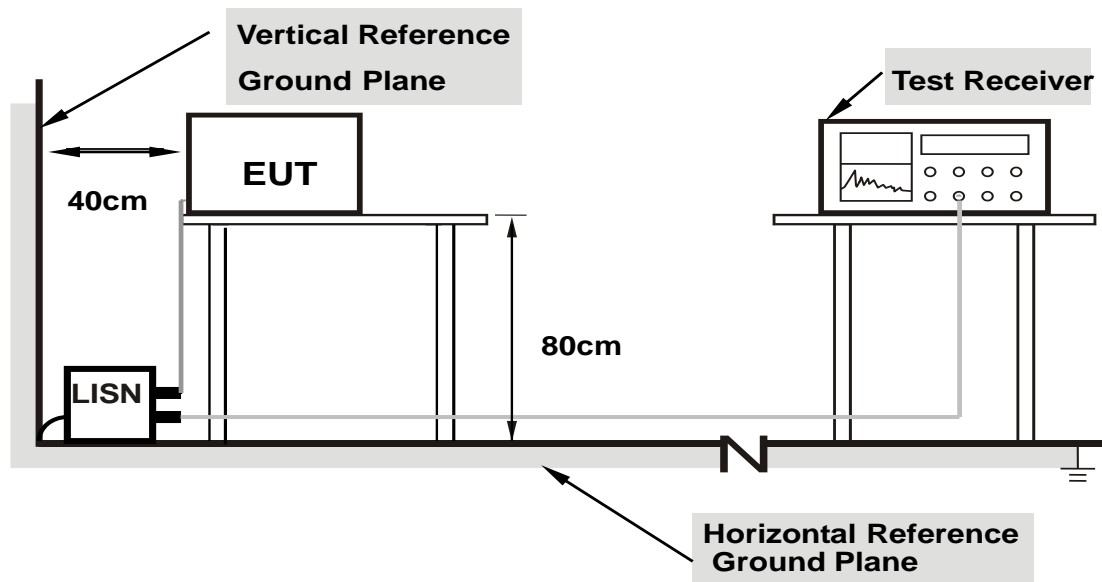

Note: 1. Support units were connected to second LISN.

2. Both of LISNs (AMN) are 80 cm from EUT and at least 80 cm from other units and other metal planes support units.



3.4 TEST RESULTS

| | |
|----------------------------|-----------------------|
| Project: LGT24A182 | Test Engineer: LiuH |
| EUT: Suck-O-Mat 3.0 | Temperature: 20.8°C |
| M/N: 5401380 | Humidity: 62%RH |
| Test Voltage: AC 120V/60Hz | Test Data: 2024-03-04 |
| Test Mode: 433M TX | |
| Note: | |

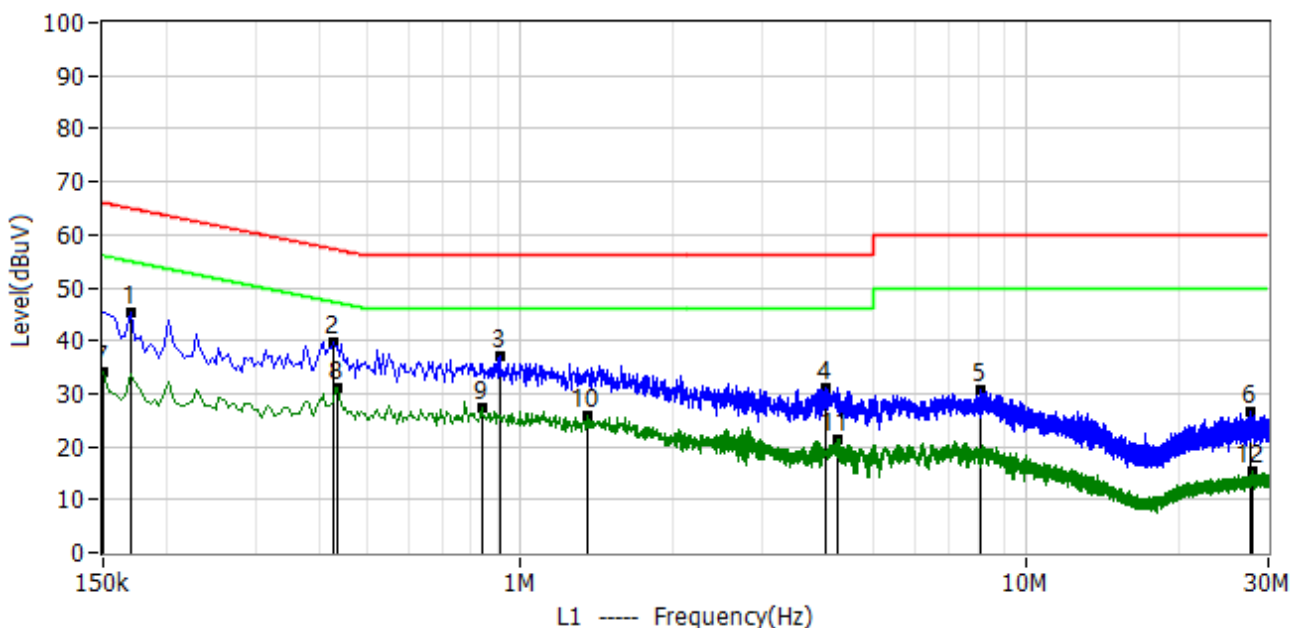

| No. | Frequency MHz | Reading dBuV | Factor dB | Level dBuV | Limit dBuV | Margin dB | Detector | Polar |
|-----|---------------|--------------|-----------|------------|------------|-----------|----------|-------|
| 1* | 0.170 | 34.99 | 10.49 | 45.48 | 64.96 | -19.48 | QP | L1 |
| 2* | 0.426 | 29.28 | 10.50 | 39.78 | 57.33 | -17.55 | QP | L1 |
| 3* | 0.910 | 26.44 | 10.51 | 36.95 | 56.00 | -19.05 | QP | L1 |
| 4* | 3.998 | 20.34 | 10.77 | 31.11 | 56.00 | -24.89 | QP | L1 |
| 5* | 8.138 | 19.72 | 10.90 | 30.62 | 60.00 | -29.38 | QP | L1 |
| 6* | 27.574 | 15.17 | 11.30 | 26.47 | 60.00 | -33.53 | QP | L1 |
| 7* | 0.150 | 23.51 | 10.49 | 34.00 | 56.00 | -22.00 | AV | L1 |
| 8* | 0.434 | 20.64 | 10.50 | 31.14 | 47.18 | -16.03 | AV | L1 |
| 9* | 0.838 | 16.75 | 10.51 | 27.26 | 46.00 | -18.74 | AV | L1 |
| 10* | 1.358 | 15.20 | 10.59 | 25.79 | 46.00 | -20.21 | AV | L1 |
| 11* | 4.226 | 10.52 | 10.78 | 21.30 | 46.00 | -24.70 | AV | L1 |
| 12* | 27.910 | 3.88 | 11.38 | 15.26 | 50.00 | -34.74 | AV | L1 |



| | |
|----------------------------|-----------------------|
| Project: LGT24A182 | Test Engineer: LiuH |
| EUT: Suck-O-Mat 3.0 | Temperature: 20.8°C |
| M/N: 5401380 | Humidity: 62%RH |
| Test Voltage: AC 120V/60Hz | Test Data: 2024-03-04 |
| Test Mode: 433M TX | |
| Note: | |

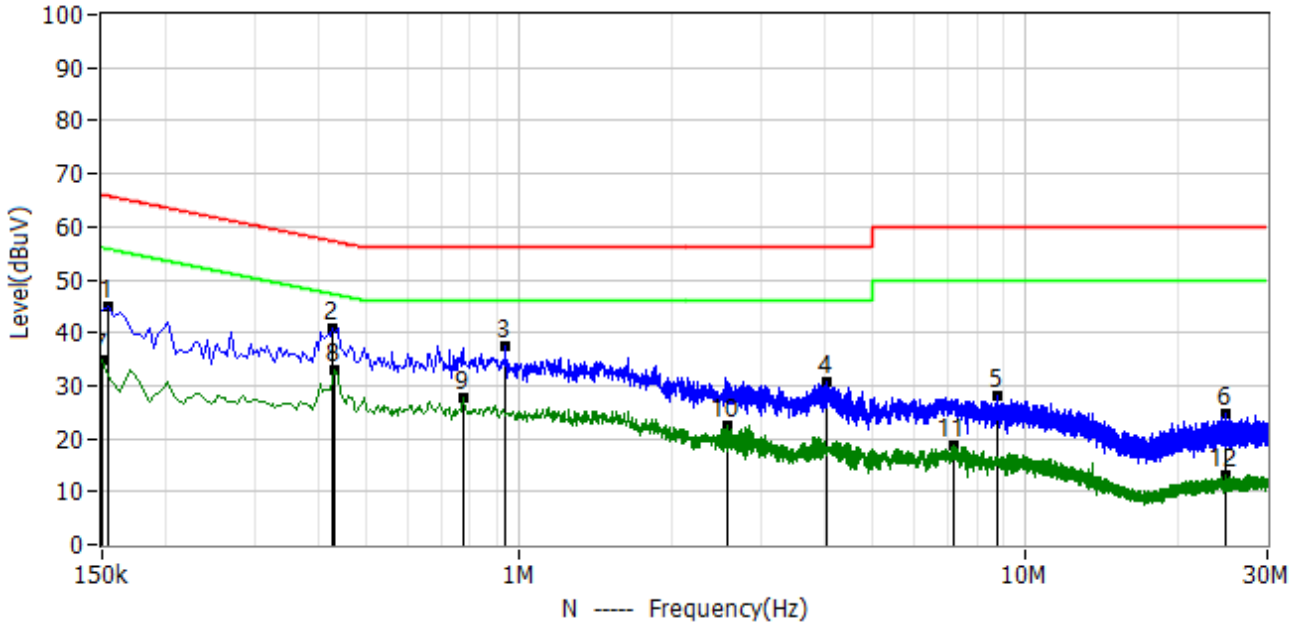

| No. | Frequency MHz | Reading dBuV | Factor dB | Level dBuV | Limit dBuV | Margin dB | Detector | Polar |
|-----|---------------|--------------|-----------|------------|------------|-----------|----------|-------|
| 1* | 0.154 | 34.38 | 10.49 | 44.87 | 65.78 | -20.91 | QP | N |
| 2* | 0.426 | 30.37 | 10.49 | 40.86 | 57.33 | -16.47 | QP | N |
| 3* | 0.938 | 26.94 | 10.51 | 37.45 | 56.00 | -18.55 | QP | N |
| 4* | 4.058 | 20.01 | 10.78 | 30.79 | 56.00 | -25.21 | QP | N |
| 5* | 8.830 | 17.11 | 10.97 | 28.08 | 60.00 | -31.92 | QP | N |
| 6* | 24.882 | 13.50 | 11.32 | 24.82 | 60.00 | -35.18 | QP | N |
| 7* | 0.150 | 24.45 | 10.49 | 34.94 | 56.00 | -21.06 | AV | N |
| 8* | 0.430 | 22.62 | 10.49 | 33.11 | 47.25 | -14.15 | AV | N |
| 9* | 0.774 | 17.15 | 10.51 | 27.66 | 46.00 | -18.34 | AV | N |
| 10* | 2.586 | 11.82 | 10.74 | 22.56 | 46.00 | -23.44 | AV | N |
| 11* | 7.190 | 7.74 | 10.88 | 18.62 | 50.00 | -31.38 | AV | N |
| 12* | 24.826 | 1.72 | 11.32 | 13.04 | 50.00 | -36.96 | AV | N |



4. RADIATED EMISSION MEASUREMENT

4.1 RADIATED EMISSION LIMITS

In case the emission fall within the restricted band specified on Part 15.205(a), then the Part 15.209(a) and Part 15.231(b) limit in the table below has to be followed.

LIMITS OF RADIATED EMISSION MEASUREMENT (0.009MHz - 1000MHz)

| Frequencies (MHz) | Field Strength (microvolts/meter) | Measurement Distance (meters) |
|-------------------|-----------------------------------|-------------------------------|
| 0.009~0.490 | 2400/F(KHz) | 300 |
| 0.490~1.705 | 24000/F(KHz) | 30 |
| 1.705~30.0 | 30 | 30 |
| 30~40.66 | 100 | 3 |
| 40.70~70 | 100 | 3 |

| Fundamental Frequency (MHz) | Field Strength of fundamental (microvolts/meter) | Field Strength of Unwanted Emissions (microvolts/meter) |
|-----------------------------|--|---|
| 40.66~40.70 | 2,250 | 225 |
| 70~130 | 1,250 | 125 |
| 130~174 | 1,250 to 3,750** | 125 to 375** |
| 174~260 | 3750 | 375 |
| 260~470 | 3,750 to 12,500** | 375 to 1,250** |
| Above 470 | 12,500 | 1,250 |

LIMITS OF RADIATED EMISSION MEASUREMENT (Above 1000MHz)

| FREQUENCY (MHz) | Class B (dBuV/m) (at 3M) | |
|-----------------|--------------------------|---------|
| | PEAK | AVERAGE |
| Above 1000 | 74 | 54 |

NOTE:

- (1) The limit for radiated test was performed according to FCC PART 15C.
- (2) Emission level (dBuV/m)=20log Emission level (uV/m).



LIMITS OF RESTRICTED FREQUENCY BANDS

| FREQUENCY (MHz) | FREQUENCY (MHz) | FREQUENCY (MHz) | FREQUENCY (GHz) |
|-------------------|---------------------|-----------------|-----------------|
| 0.090-0.110 | 16.42-16.423 | 399.9-410 | 4.5-5.15 |
| 0.495-0.505 | 16.69475-16.69525 | 608-614 | 5.35-5.46 |
| 2.1735-2.1905 | 16.80425-16.80475 | 960-1240 | 7.25-7.75 |
| 4.125-4.128 | 25.5-25.67 | 1300-1427 | 8.025-8.5 |
| 4.17725-4.17775 | 37.5-38.25 | 1435-1626.5 | 9.0-9.2 |
| 4.20725-4.20775 | 73-74.6 | 1645.5-1646.5 | 9.3-9.5 |
| 6.215-6.218 | 74.8-75.2 | 1660-1710 | 10.6-12.7 |
| 6.26775-6.26825 | 108-121.94 | 1718.8-1722.2 | 13.25-13.4 |
| 6.31175-6.31225 | 123-138 | 2200-2300 | 14.47-14.5 |
| 8.291-8.294 | 149.9-150.05 | 2310-2390 | 15.35-16.2 |
| 8.362-8.366 | 156.52475-156.52525 | 2483.5-2500 | 17.7-21.4 |
| 8.37625-8.38675 | 156.7-156.9 | 2690-2900 | 22.01-23.12 |
| 8.41425-8.41475 | 162.0125-167.17 | 3260-3267 | 23.6-24.0 |
| 12.29-12.293 | 167.72-173.2 | 3332-3339 | 31.2-31.8 |
| 12.51975-12.52025 | 240-285 | 3345.8-3358 | 36.43-36.5 |
| 12.57675-12.57725 | 322-335.4 | 3600-4400 | Above 38.6 |
| 13.36-13.41 | | | |

| Spectrum Parameter | Setting |
|---------------------------------------|-----------------------|
| Detector | Peak |
| Attenuation | Auto |
| Start Frequency | 1000 MHz |
| Stop Frequency | 10th carrier harmonic |
| RB / VB (emission in restricted band) | 1MHz / 3MHz |

| Receiver Parameter | Setting |
|------------------------|--------------------------------------|
| Attenuation | Auto |
| Start ~ Stop Frequency | 9kHz~90kHz / RB 200Hz for PK & AV |
| Start ~ Stop Frequency | 90kHz~110kHz / RB 200Hz for QP |
| Start ~ Stop Frequency | 110kHz~490kHz / RB 200Hz for PK & AV |
| Start ~ Stop Frequency | 490kHz~30MHz / RB 9kHz for QP |
| Start ~ Stop Frequency | 30MHz~1000MHz / RB 120kHz for QP |



4.2 TEST PROCEDURE

- a. The test is performed in a 3m Semi-Anechoic Chamber; the antenna factor, cable loss and so on of the site (factors) is calculated to correct the reading. The EUT is placed on a 0.8m high insulating Turn Table, and keeps 3m away from the Test Antenna, which is mounted on a variable-height antenna master tower.
During test, The table was rotated 360 degrees to determine the position of the highest radiation.
 - b. In the frequency range of 9KHz to 30MHz, magnetic field is measured with Loop Test Antenna. The Test Antenna is positioned with its plane vertical at 1m distance from the EUT. The center of the Loop Test Antenna is 1m above the ground. During the measurement the Loop Test Antenna rotates about its vertical axis for maximum response at each azimuth about the EUT.
 - c. In the frequency range 30MHz-1GHz, Bi-Log Test Antenna used. Test Antenna is 3m away from the EUT. Test Antenna height is varied from 1m to 4m above the ground to determine the maximum value of the field strength. The emission levels at both horizontal and vertical polarizations should be tested.
 - d. In the frequency above 1GHz, Place the measurement antenna 3m away from the EUT for each area of the EUT determined to be a source of emissions at the specified measurement distance, while keeping the measurement antenna aimed at the source of emissions at each frequency of significant emissions, with polarization oriented for maximum response. The measurement antenna elevation for maximum emissions shall be restricted to a range of heights of from 1 m to 4 m above the ground or reference ground plane.
 - f. The initial step in collecting conducted emission data is a spectrum analyzer peak detector mode pre-scanning the measurement frequency range. Significant peaks are then marked and then Quasi Peak detector mode re-measured.
 - g. If the Peak Mode measured value compliance with and lower than Quasi Peak Mode Limit, the EUT shall be deemed to meet QP Limits and then no additional QP Mode measurement performed.
 - h. For the actual test configuration, please refer to the related Item –EUT Test Photos.
- Both horizontal and vertical antenna polarities and performed pretest to three orthogonal axis were tested. The worst case emissions were reported

4.3 DEVIATION FROM TEST STANDARD

No deviation

4.4 TEST SETUP

(A) Radiated Emission Test-Up Frequency Below 30MHz

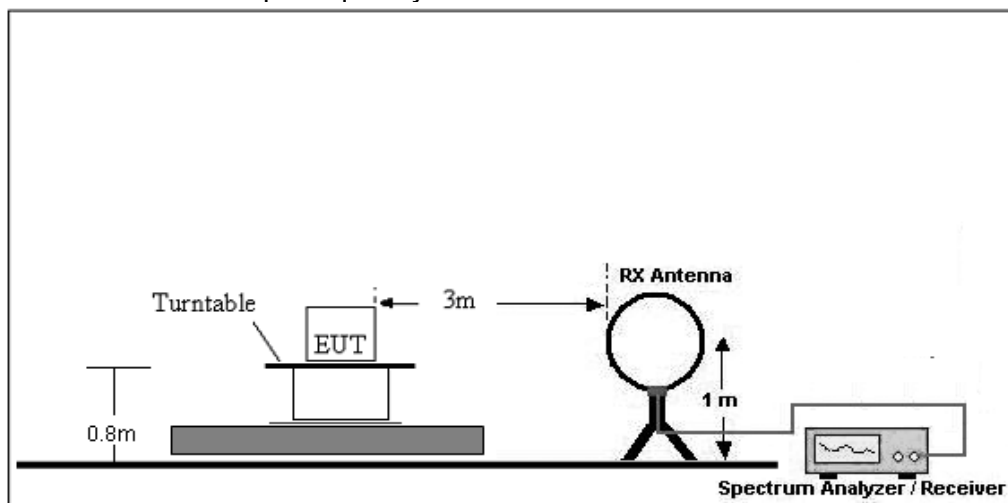

(B) Radiated Emission Test-Up Frequency 30MHz~1GHz

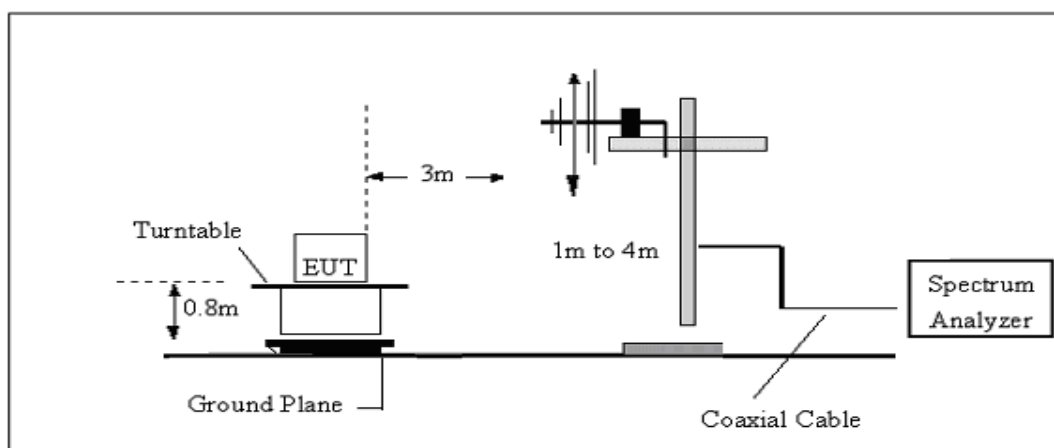

(C) Radiated Emission Test-Up Frequency Above 1GHz

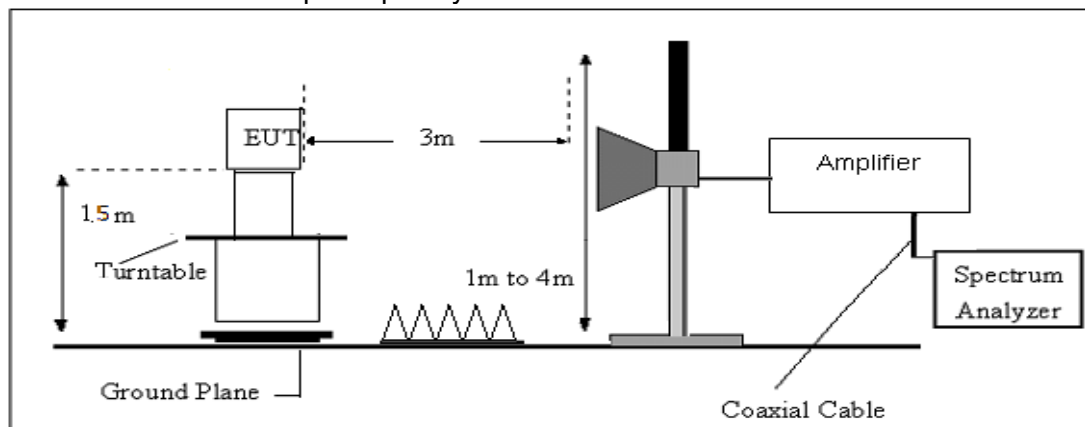



4.5 EUT OPERATING CONDITIONS

The EUT tested system was configured as the statements of 2.4 Unless otherwise a special operating condition is specified in the follows during the testing.

4.6 TEST RESULTS

INTRODUCTION TO PDCF

Reference: (§15.35 Measurement detector functions and bandwidths.)

- a. Part 15 of the FCC Rules provides for the operation of low power communication devices without an individual license (e.g., intrusion detectors, pulsed water tank level gauges, etc.), subject to certain requirements. Some of these devices use extremely narrow pulses to generate wideband emissions, which are measured to determine compliance with the rules. These measurements are typically performed with a receiver or spectrum analyzer. Depending on a number of factors (e.g., resolution bandwidth, pulsewidth, etc.), the spectrum analyzer may not always display the true peak value of the measured emission. This effect, called “pulse desensitization,” relates to the capabilities of the measuring instrument. For the measurement and reporting of the true peak of pulsed emissions, it may be necessary to apply a “pulse desensitization correction factor” (PDCF) to the measured value, pursuant to 47 CFR 15.35(a).

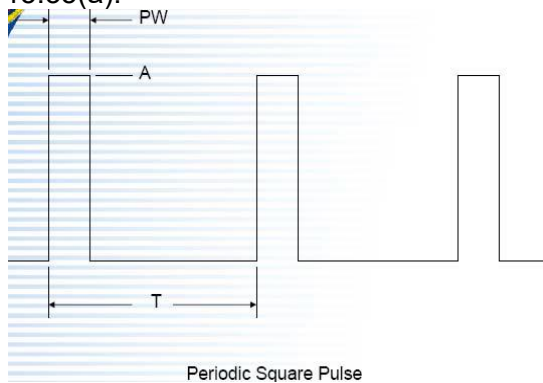

Periodic Square Pulse

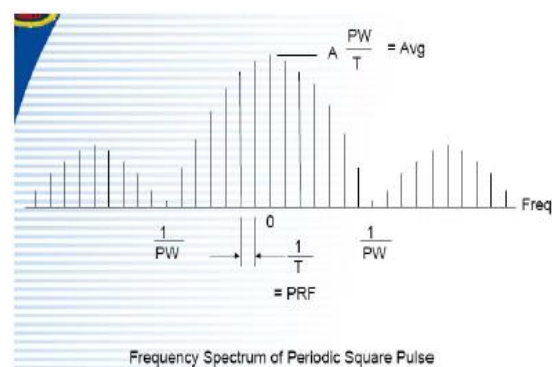

Frequency Spectrum of Periodic Square Pulse

If using spectrum analyzer to measure pulse signal, it have to make sure the RBW use is at least $2/PW$.

•When RBW is less than $2/PW$, you are able to measure the true peak level of the pulse signal. If this is the case, PDCF is required to compensate to determine true peak value.

Pulse desensitization:

$PW = 42600\text{usec}$, $\text{Period} = 96600\text{usec}$, $\text{Level} = A$

$RBW > 2/PW = 0.047K$, $1/T = 0.023K$

NOTE: $2 / PW < RBW$, first don't need

- b. For the actual test, please refer to the ANSI C63.10, Annex C refer to section 6. for more detail



4.7 FIELD STRENGTH CALCULATION

The field strength is calculated by adding the Antenna Factor and Cable Factor and subtracting the Amplifier Gain and Duty Cycle Correction Factor (if any) from the measured reading. The basic equation with a sample calculation is as follows:

$$FS = RA + AF + CL - AG$$

Where

FS = Field Strength

CL = Cable Attenuation Factor (Cable Loss)

RA = Reading Amplitude

AG = Amplifier Gain

AF = Antenna Factor

For example

| Frequency (MHz) | FS (dB μ V/m) | RA (dB μ V/m) | AF (dB) | CL (dB) | AG (dB) | Factor (dB) |
|--------------------|----------------------|----------------------|------------|------------|------------|----------------|
| 300 | 40 | 58.1 | 12.2 | 1.6 | 31.9 | -18.1 |

$$\text{Factor} = \text{AF} + \text{CL} - \text{AG}$$

4.8 TEST RESULTS

(Radiated Emission < 30MHz (9KHz-30MHz, H-field))

| Freq. (MHz) | Reading (dBuV/m) | Limit (dBuV/m) | Margin (dB) | State P/F |
|----------------|---------------------|-------------------|----------------|--------------|
| -- | -- | -- | -- | PASS |
| -- | -- | -- | -- | PASS |

Note: The amplitude of spurious emissions which are attenuated by more than 20dB below the permissible value has no need to be reported.

Distance extrapolation factor = $40 \log(\text{specific distance}/\text{test distance})$ (dB);

Limit line = specific limits (dBuV) + distance extrapolation factor.



Between 30MHz – 5000 MHz

| | |
|-----------------------|-----------------------------|
| Project: LGT24A182 | Test Engineer: Xiangdong Ma |
| EUT: Suck-O-Mat 3.0 | Temperature: 26°C |
| M/N: 5401380 | Humidity: 59%RH |
| Test Voltage: Battery | Test Data: 2024-04-18 |
| Test Mode: 433M TX | |
| Note: | |

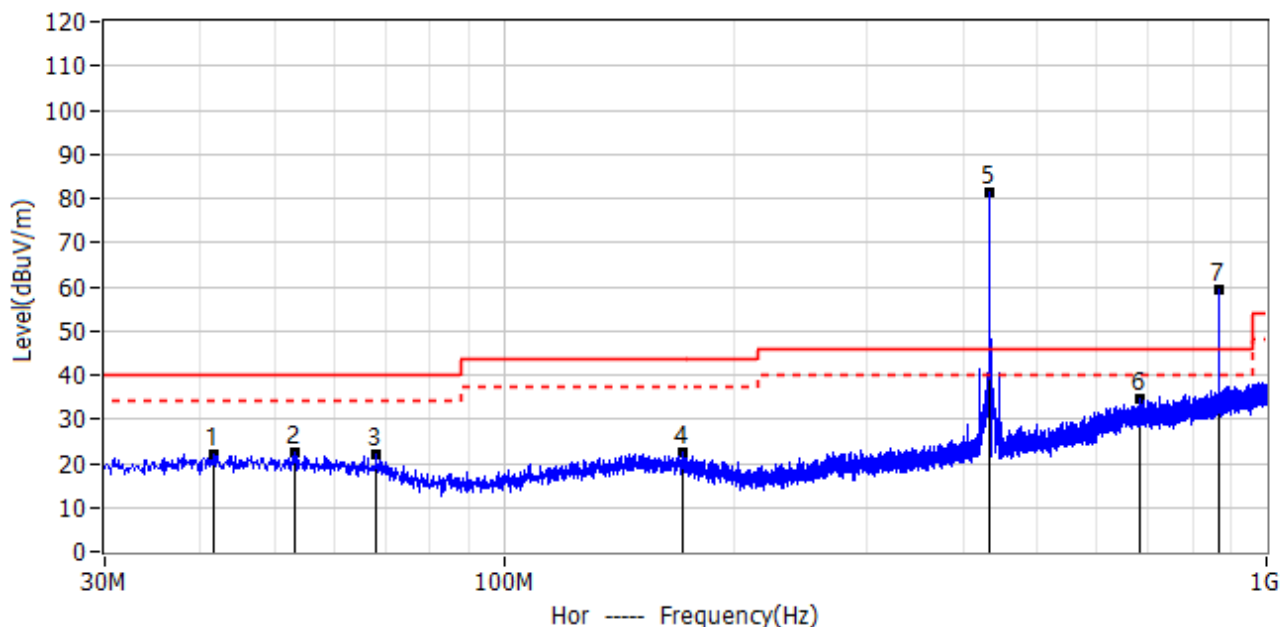

| No. | Frequency MHz | Reading dBuV | Factor dB/m | Level dBuV/m | Limit dBuV/m | Margin dB | Detector | Polar |
|-----|---------------|--------------|-------------|--------------|--------------|-----------|----------|-------|
| 1* | 41.640 | 2.85 | 19.33 | 22.18 | 40.00 | -17.82 | PK | Hor |
| 2* | 53.159 | 3.21 | 19.13 | 22.34 | 40.00 | -17.66 | PK | Hor |
| 3* | 67.951 | 4.00 | 18.15 | 22.15 | 40.00 | -17.85 | PK | Hor |
| 4* | 171.620 | 2.79 | 19.63 | 22.42 | 43.50 | -21.08 | PK | Hor |
| !5* | 433.884 | 58.00 | 23.42 | 81.42 | 100.83 | -19.41 | PK | Hor |
| 6* | 682.204 | 4.82 | 29.61 | 34.43 | 46.00 | -11.57 | PK | Hor |
| !7* | 867.959 | 26.63 | 32.73 | 59.36 | 80.83 | -21.47 | PK | Hor |
| !5* | 433.884 | 81.42 | -6.85 | 74.57 | 80.83 | -6.26 | QP | Hor |
| !7* | 867.959 | 59.36 | -6.85 | 52.51 | 60.83 | -8.32 | QP | Hor |



| | |
|-----------------------|-----------------------------|
| Project: LGT24A182 | Test Engineer: Xiangdong Ma |
| EUT: Suck-O-Mat 3.0 | Temperature: 26°C |
| M/N: 5401380 | Humidity: 59%RH |
| Test Voltage: Battery | Test Data: 2024-04-18 |
| Test Mode: 433M TX | |
| Note: | |

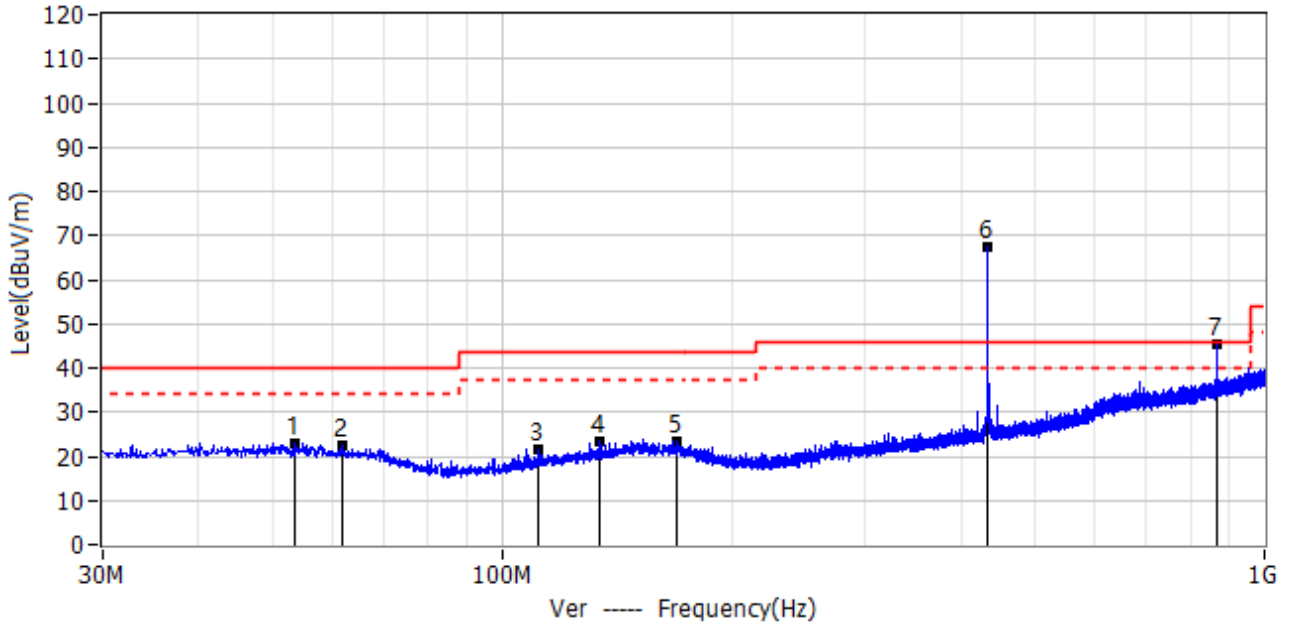

| No. | Frequency MHz | Reading dBuV | Factor dB/m | Level dBuV/m | Limit dBuV/m | Margin dB | Detector | Polar |
|-----|---------------|--------------|-------------|--------------|--------------|-----------|----------|-------|
| 1* | 53.644 | 3.74 | 19.10 | 22.84 | 40.00 | -17.16 | PK | Ver |
| 2* | 61.646 | 4.03 | 18.54 | 22.57 | 40.00 | -17.43 | PK | Ver |
| 3* | 111.965 | 4.65 | 16.95 | 21.60 | 43.50 | -21.90 | PK | Ver |
| 4* | 134.639 | 4.76 | 18.75 | 23.51 | 43.50 | -19.99 | PK | Ver |
| 5* | 169.316 | 3.74 | 19.79 | 23.53 | 43.50 | -19.97 | PK | Ver |
| !6* | 433.884 | 43.80 | 23.42 | 67.22 | 100.83 | -33.61 | PK | Ver |
| 7* | 867.838 | 12.65 | 32.73 | 45.38 | 80.83 | -35.45 | PK | Ver |
| !6* | 433.884 | 67.22 | -6.85 | 60.37 | 80.83 | -20.46 | QP | Ver |
| 7* | 867.838 | 45.38 | -6.85 | 38.53 | 60.83 | -22.30 | QP | Ver |



| | |
|-----------------------|-----------------------------|
| Project: LGT24A182 | Test Engineer: Xiangdong Ma |
| EUT: Suck-O-Mat 3.0 | Temperature: 26°C |
| M/N: 5401380 | Humidity: 59%RH |
| Test Voltage: Battery | Test Data: 2024-04-22 |
| Test Mode: 433M TX | |
| Note: | |

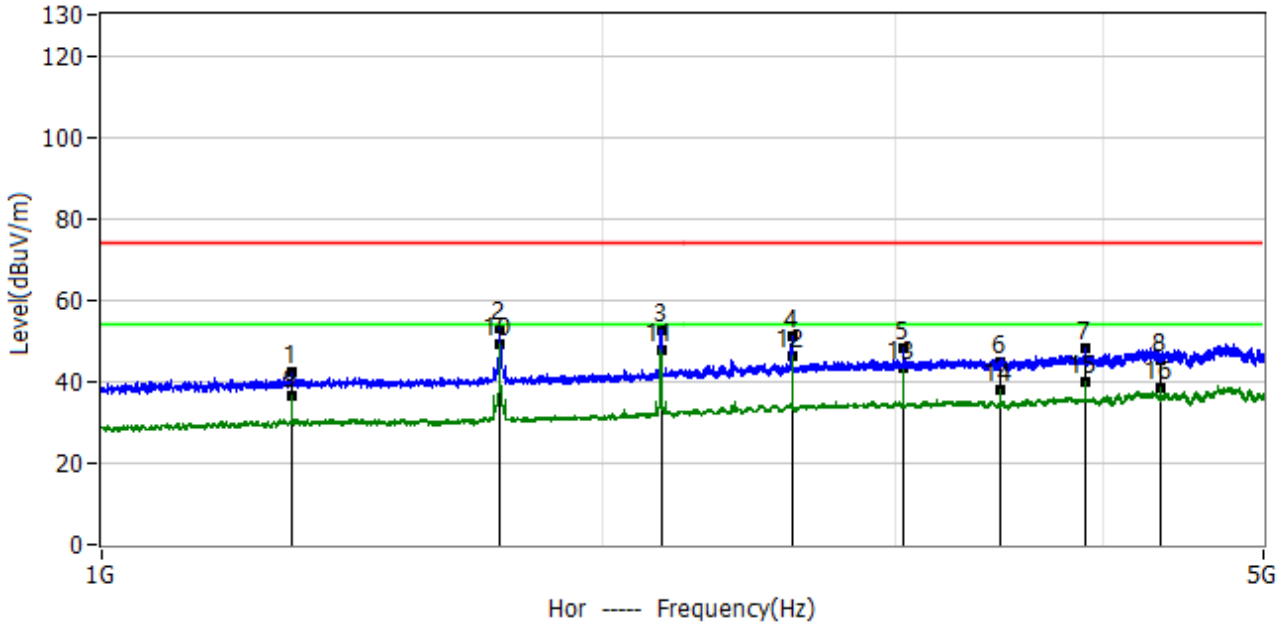

| No. | Frequency | Reading dBuV | Factor dB/m | Level dBuV/m | Limit dBuV/m | Margin dB | Detector | Polar |
|-----|-----------|--------------|-------------|--------------|--------------|-----------|----------|-------|
| 1* | 1.302GHz | 64.64 | -22.47 | 42.17 | 80.83 | -38.66 | PK | Hor |
| 2* | 1.734GHz | 73.09 | -20.02 | 53.07 | 80.83 | -27.76 | PK | Hor |
| 3* | 2.170GHz | 68.40 | -16.00 | 52.40 | 80.83 | -28.43 | PK | Hor |
| 4* | 2.604GHz | 62.91 | -11.94 | 50.97 | 80.83 | -29.86 | PK | Hor |
| 5* | 3.038GHz | 58.55 | -10.14 | 48.41 | 80.83 | -32.42 | PK | Hor |
| 6* | 3.472GHz | 54.46 | -9.76 | 44.70 | 80.83 | -36.13 | PK | Hor |
| 7* | 3.905GHz | 57.03 | -8.99 | 48.04 | 80.83 | -32.79 | PK | Hor |
| 8* | 4.340GHz | 53.80 | -8.60 | 45.20 | 80.83 | -35.63 | PK | Hor |
| 1* | 1.302GHz | 42.17 | -6.85 | 35.32 | 60.83 | -25.51 | AV | Hor |
| 2* | 1.734GHz | 53.07 | -6.85 | 46.22 | 60.83 | -14.61 | AV | Hor |
| 3* | 2.170GHz | 52.40 | -6.85 | 45.55 | 60.83 | -15.28 | AV | Hor |
| 4* | 2.604GHz | 50.97 | -6.85 | 44.12 | 60.83 | -16.71 | AV | Hor |
| 5* | 3.038GHz | 48.41 | -6.85 | 41.56 | 60.83 | -19.27 | AV | Hor |
| 6* | 3.472GHz | 44.70 | -6.85 | 37.85 | 60.83 | -22.98 | AV | Hor |
| 7* | 3.905GHz | 48.04 | -6.85 | 41.19 | 60.83 | -19.64 | AV | Hor |
| 8* | 4.340GHz | 45.20 | -6.85 | 38.35 | 60.83 | -22.48 | AV | Hor |



| | |
|-----------------------|-----------------------------|
| Project: LGT24A182 | Test Engineer: Xiangdong Ma |
| EUT: Suck-O-Mat 3.0 | Temperature: 26°C |
| M/N: 5401380 | Humidity: 59%RH |
| Test Voltage: Battery | Test Data: 2024-04-18 |
| Test Mode: 433M TX | |
| Note: | |

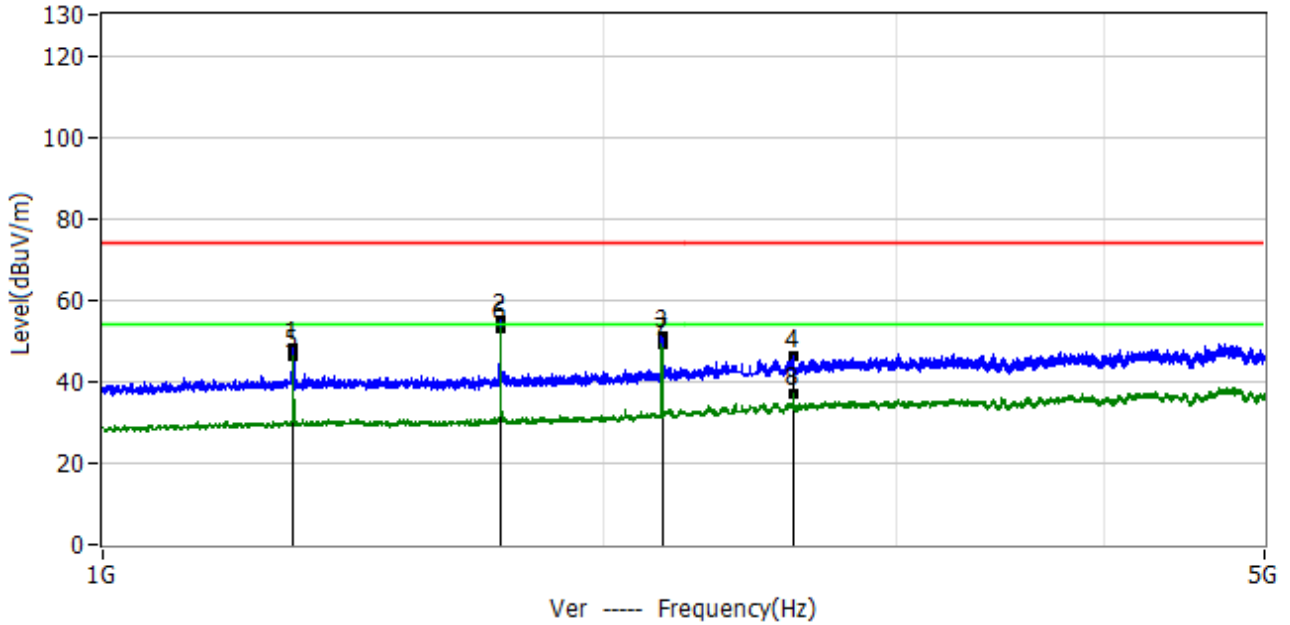

| No. | Frequency | Reading dBuV | Factor dB/m | Level dBuV/m | Limit dBuV/m | Margin dB | Detector | Polar |
|-----|-----------|--------------|-------------|--------------|--------------|-----------|----------|-------|
| 1* | 1.302GHz | 70.81 | -22.47 | 48.34 | 80.83 | -32.49 | PK | Ver |
| 2* | 1.736GHz | 75.06 | -20.00 | 55.06 | 80.83 | -25.77 | PK | Ver |
| 3* | 2.170GHz | 67.33 | -16.00 | 51.33 | 80.83 | -29.50 | PK | Ver |
| 4* | 2.604GHz | 58.16 | -11.94 | 46.22 | 80.83 | -34.61 | PK | Ver |
| 1* | 1.302GHz | 48.34 | -6.85 | 41.49 | 60.83 | -19.34 | AV | Ver |
| 2* | 1.736GHz | 55.06 | -6.85 | 48.21 | 60.83 | -12.62 | AV | Ver |
| 3* | 2.170GHz | 51.33 | -6.85 | 44.48 | 60.83 | -16.35 | AV | Ver |
| 4* | 2.604GHz | 46.22 | -6.85 | 39.37 | 60.83 | -21.46 | AV | Ver |



5. BANDWIDTH TEST

5.1 LIMIT

| FCC Part15.231,Subpart C | | | |
|--------------------------|--------------|---|--------|
| Section | Test Item | Limit | Result |
| 15.231(C) | 20 Bandwidth | The20dB bandwidth of the emissions shall not exceed 0.25% of the center frequency | PASS |

| Spectrum Parameter | Setting |
|--------------------|-------------------------|
| Attenuation | Auto |
| Span Frequency | > Measurement Bandwidth |
| RB | 10 kHz (20dB Bandwidth) |
| VB | 30 kHz (20dB Bandwidth) |
| Detector | Peak |
| Trace | Max Hold |
| Sweep Time | Auto |

5.2 TEST REQUIREMENTS

The bandwidth of the emission shall be no wider than 0.25% of the center frequency for devices operating above 70 MHz and below 900 MHz. For devices operating above 900 MHz, the emission shall be no wider than 0.5% of the center frequency. Bandwidth is determined at the points 20 dB down from the modulated carrier.

5.3 TEST PROCEDURE

- a. The EUT was directly connected to the spectrum analyzer and antenna output port as show in the block diagram below.
- b. Spectrum Setting: RBW= 10KHz, VBW=30KHz, Sweep time = Auto.

5.4 TEST SETUP



5.5 EUT OPERATION CONDITIONS

TX mode.



5.6 TEST RESULTS

| Centre Frequency (MHz) | 20dB Bandwidth (KHz) | Limit (MHz) | Result |
|------------------------|----------------------|-------------|--------|
| 433.94 | 425.1 | 1.08485 | Pass |

433.94MHz

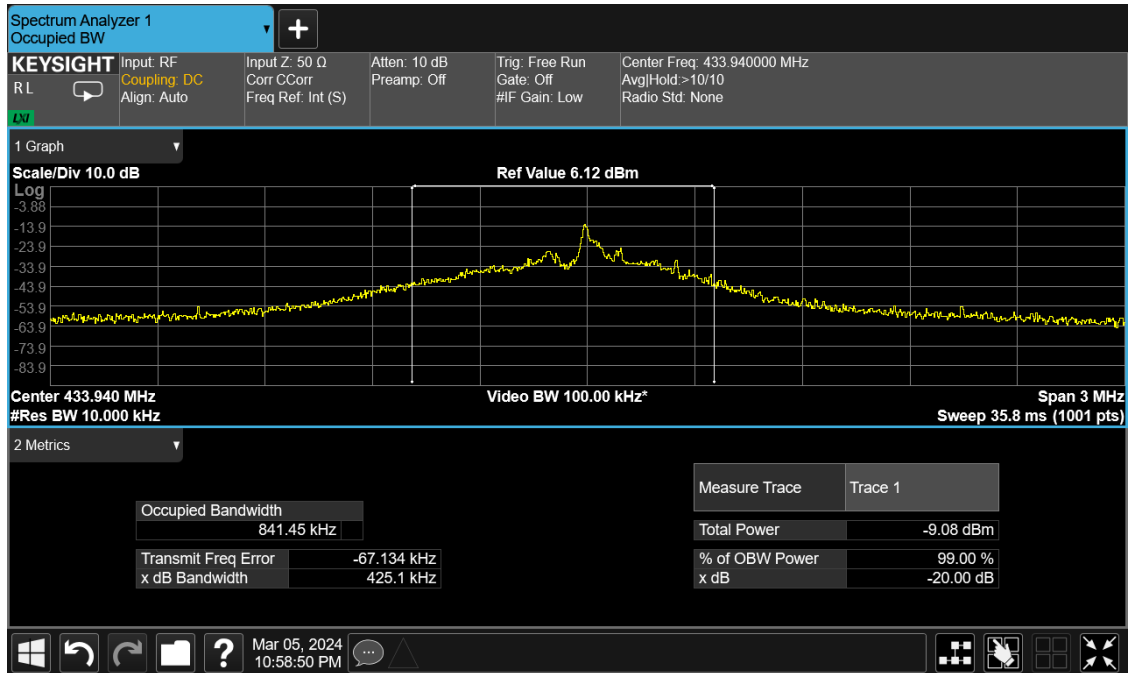



6. DUTY CYCLE

6.1 TEST PROCEDURE

The EUT was directly connected to the spectrum analyzer and antenna output port as show in the block diagram below.

The Duty Cycle Was Determined By The Following Equation: To Calculate The Actual Field Intensity,The Duty Cycle Correction Factor In Decibel Is Needed For Later Use And Can Be Obtained From Following Conversion

Duty Cycle(%)=Total On Interval In A Complete Pulse Train/ Length Of A Complete Pulse Train * %

Duty Cycle Correction Factor(Db)=20 * Log10(Duty Cycle(%))

6.2 TEST SETUP



6.3 EUT OPERATION CONDITIONS

TX mode.



6.4 TEST RESULTS

| | |
|-------------------|--------|
| On time (ms) | 37.44 |
| Pulse period (ms) | 82.4 |
| Duty Cycle (%) | 45.44% |
| PDCF | -6.85 |

Refer to the duty cycle plot (as below), This device meets the FCC requirement. Length of a complete pulse train

Remark:FCC part15.35(c) required that a complete pulse train is more than 0.1 seconds, the measured field strength shall be determined from the average absolute voltage during a 0.1 second interval during which the field strength is at its maximum value.

Note:

Number of pulse train 1 = 18, Time of single pulse train 1 = 1.242ms;

Number of pulse train 2 = 7, Time of single pulse train 2 = 0.402ms;

Total on interval in a complete pulse train= Number of pulse train 1 x Time of single pulse train 1+ Number of pluse train 2 x Time of single pulse train 2=18x1.242+0.402x7=25.17ms



Pulse time

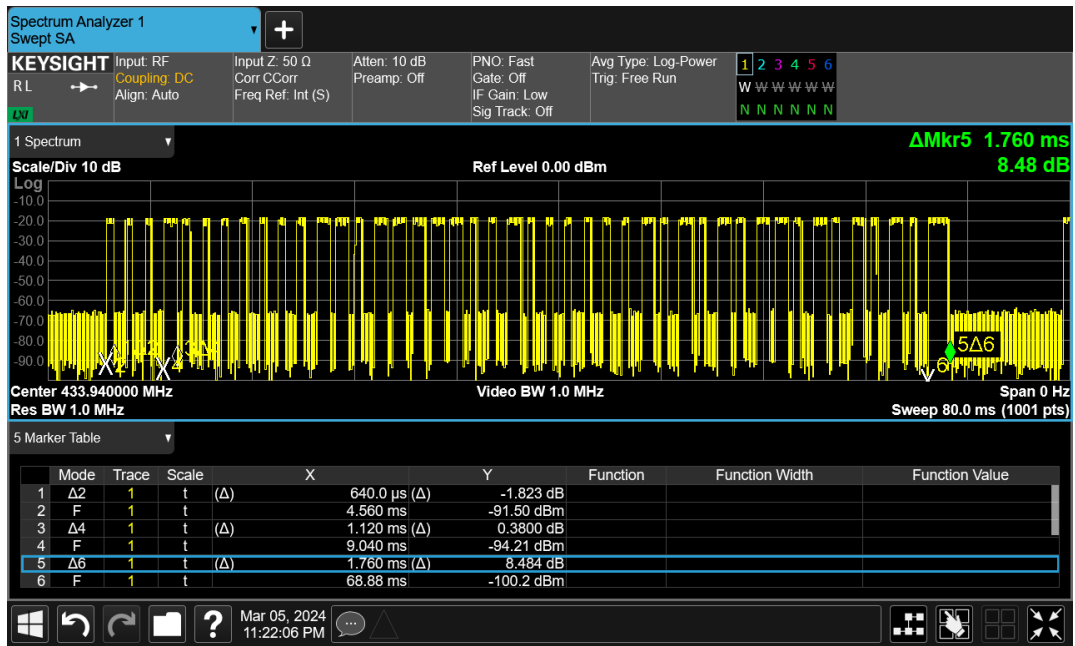

Pulse cycle

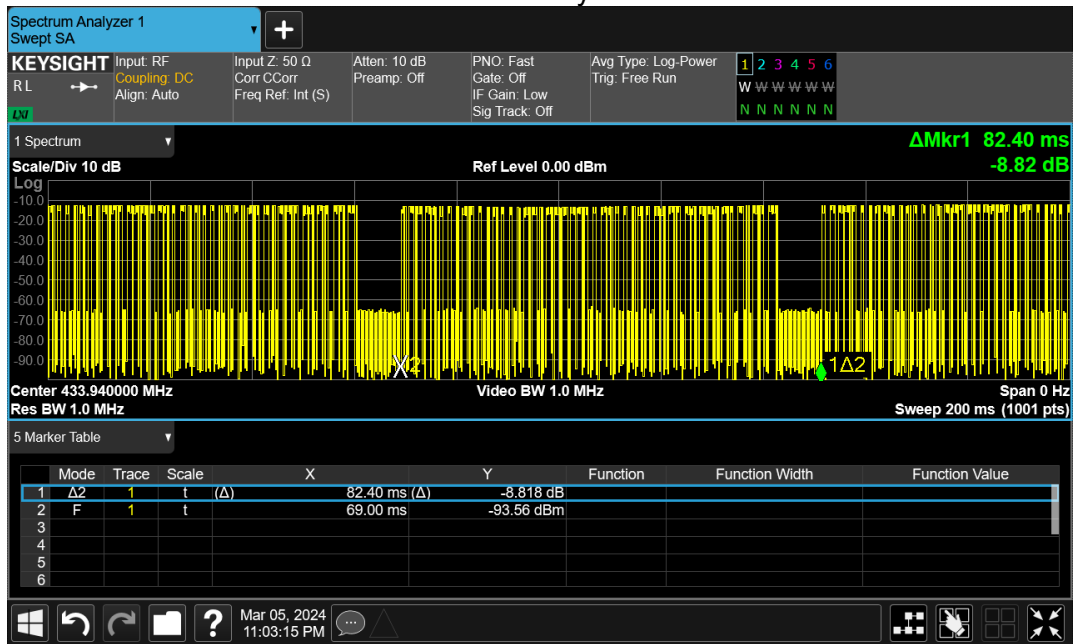



7. AUTOMATICALLY DEACTIVATE

7.1 STANDARD REQUIREMENT

A manually operated transmitter shall employ a switch that will automatically deactivate the transmitter within not more than 5 seconds of being released.

7.2 TEST PROCEDURE

The EUT was directly connected to the spectrum analyzer and antenna output port as show in the block diagram below.

Spectrum Setting : RBW= 100KHz, VBW=300KHz, Sweep time = Auto.

Note: Only press launch about 0.15 s

Note:

(1)Refer to the plot (As Below),We find a manually operated transmitter shall employ a switch that will automatically deactivate the transmitter immediately, within not more than 5 seconds of being released.

(2)The EUT is comply with FCC PART 15 clause 15.231(a)(1) manually working mode are pre-tested and only the worst result is reported.

7.3 TEST SETUP





7.4 TEST RESULTS

| Centre Frequency (MHz) | Transmission time (S) | Limit (S) | Result |
|------------------------|-----------------------|-----------|--------|
| 433.94 | 0.48 | 5 | Pass |

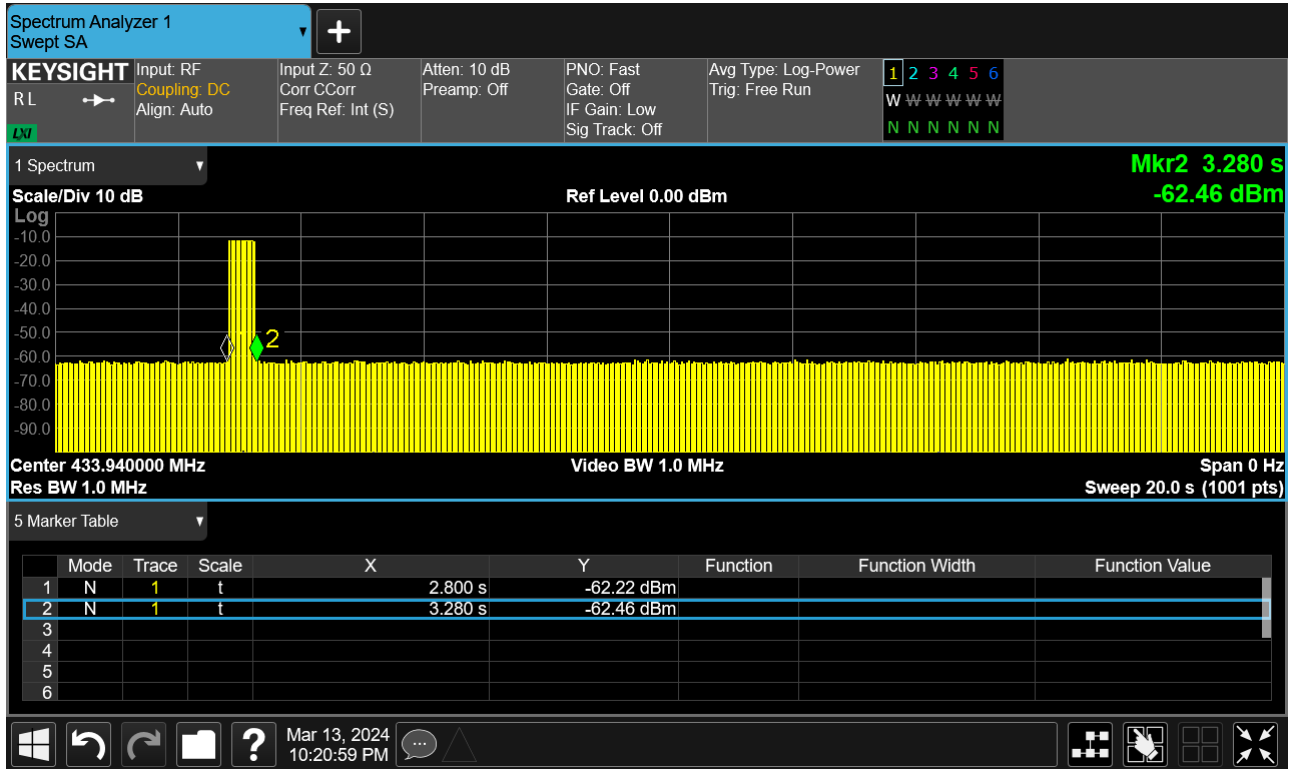



8. ANTENNA REQUIREMENT

8.1 STANDARD REQUIREMENT

According to the FCC Part 15 Paragraph 15.203, an intentional radiator shall be designed to ensure that no antenna other than that furnished by the responsible party shall be used with the device. The use of a permanently attached antenna to the intentional radiator shall be considered sufficient to comply with the provisions of this section.

8.2 EUT ANTENNA

The EUT antenna is Spring-loaded Antenna. It conforms to the standard requirements.



APPENDIX I - PHOTOS OF TEST SETUP

Note: See test photos in setup photo document for the actual connections between Product and support equipment.

*****END OF THE REPORT*****