

QOSU

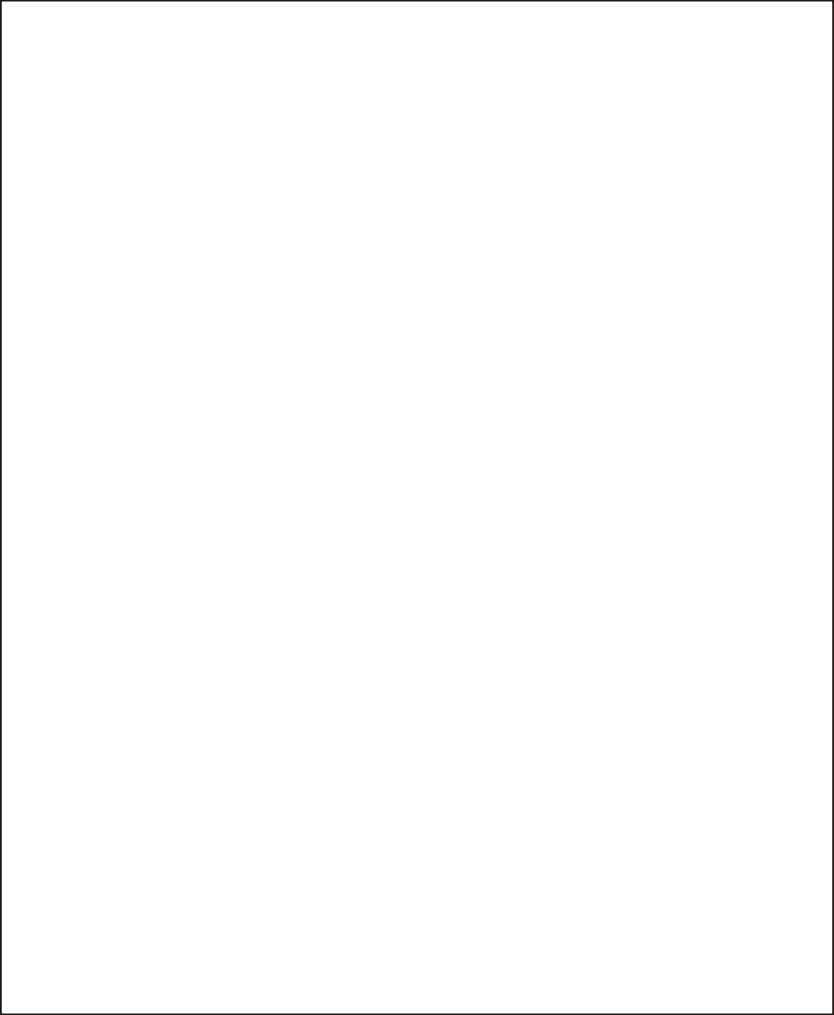

**Video Doorbell**  
**Video Doorbell ( Wi-Fi HomeBase )**  
**( Battery or Hardwired Doorbell )**

Quick Start Guide



# TABLE OF CONTENTS

<b>01</b>	What's Included	P01
<b>02</b>	Product Overview	P02-P03
<b>03</b>	How The System Works	P04
<b>04</b>	App Installation and System Setup	P05
<b>05</b>	Video Doorbell Installation	P06-P19
<b>06</b>	Notice	P20-P22
<b>07</b>	Customer Service	P23

Deal with the App for in-App setup first then come back to the physical installation.

# What's Included

---



Video Doorbell



Mounting Bracket



Screw Hole  
Positioning-Card



15° Mounting  
Wedge (Optional)



Wi-Fi HomeBase



Phillips-Head  
Screwdriver



USB-C Charging  
Cable



Extension Wires and  
Wire Nuts (Optional)

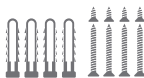

Screw Packs



Security Sticker



Quick Start Guide



Doorbell Detaching Pin

# Product Overview

---

## Video Doorbell (Battery or Hardwired)

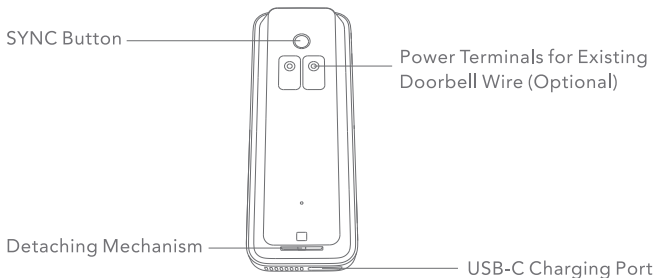
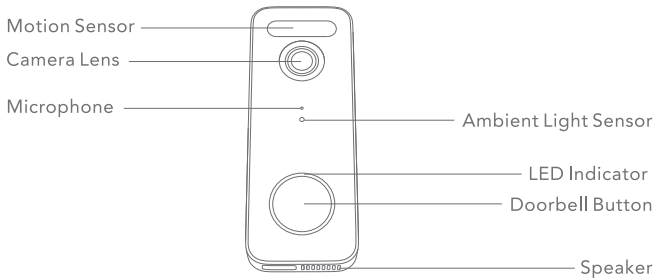

## Wi-Fi HomeBase

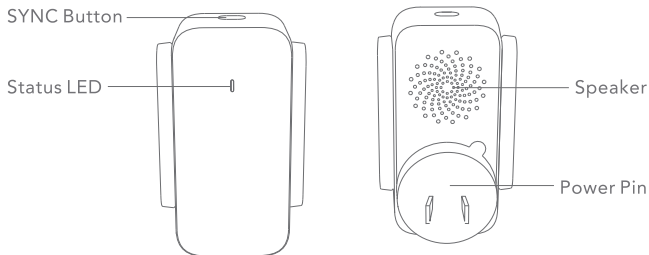

Operation	How-to
Power on	Press and release the SYNC button
Power off the doorbell	Press and hold the SYNC button for 3 seconds.
Reset the doorbell	Press and hold the SYNC button for 10 seconds.
Connect to Wi-Fi network	Press and hold the SYNC button until you hear a beep

# How The System Works

---

## What's Required for Installation

Phillips-Head Screwdriver

Power Drill with 1/4" (6.35mm) Drill Bit

## How the System Works

The video doorbell system includes 2 parts.

One is the video doorbell at your door.

The other is the Wi-Fi HomeBase in your house.

The video doorbell detects motion at your porch and allows you to answer the door anytime and anywhere.

The Wi-Fi HomeBase stores video clips on its built-in storage.

When someone rings the doorbell, people in the house will be notified.



# App Installation and Set up the System

---

1. Download the aosu app from the App Store (iOS devices) or Google Play (Android devices).
2. Scan the QR code below or search aosu in the App Store or Google Play.



Register or log into the App. Add Video Doorbell 5MP V8S and scan the QR code for later installation process.



# Video Doorbell Installation

---

## Determining The Power Option

### Option 1 - Battery Powered

1. If you don't have existing doorbell wiring at the front door, use the built-in battery. You are free to determine the doorbell position and the mounting is easy and quick.
2. When the doorbell battery level is low, you need to detach and charge it.

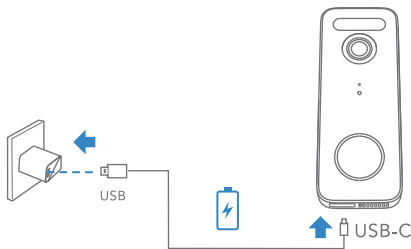
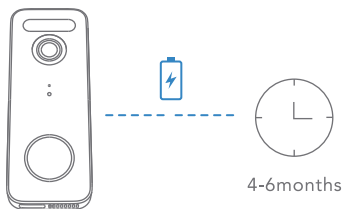

Note: The battery life varies depending on usage. In most common cases, a doorbell may have up to 10 events per day and each recording lasts 20 seconds on average. Under this scenario, the doorbell battery life can last up to 6 months.

# Option 1 -Battery Powered

## Step 1 Find a Mounting Spot

Take the video doorbell to your front door and check the live view on the App at the same time. Find a location where you can get the desired field of view.

Consider the below factors:

1. Check if you can reuse the existing holes and anchors on the wall or door frame.
2. If you want to place the doorbell close to a side wall, make sure the wall doesn't show up in the field of view. Otherwise IR light will be reflected and night vision will become blurry.
3. If you are drilling the mounting holes for the first time, the recommended mounting height is 48" / 1.2 m from the ground.
4. Use the 15° mounting wedge as a supplementary mounting bracket if you wish to see more on a specific side.

Place the Screw Hole Positioning Card against the wall to mark the position.

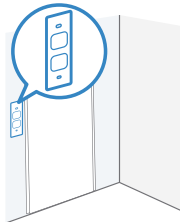
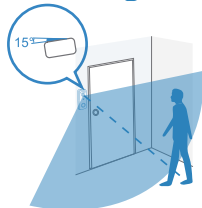
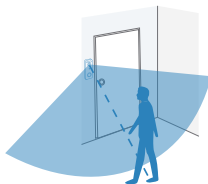
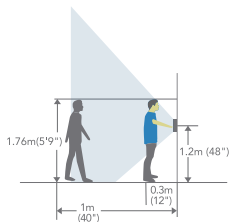

## Step 2 Mounting The Bracket

Mount the Doorbell on a Wooden Surface If you're mounting the doorbell on a wooden surface, you don't need to pre-drill pilot holes. Use the provided screws to secure the Mounting Bracket on the wall, The Screw Hole Positioning Card indicates the position of the screw holes. What is required: Screwdriver, Mounting Bracket, 15° Mounting Wedge (Optional), Screw Packs.

Without 15° Mounting Wedge

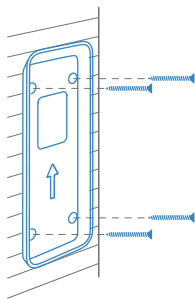

Mounting Bracket

With 15° Mounting Wedge

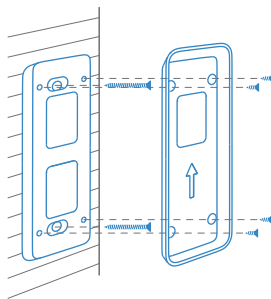

Mounting Wedge

Mounting Bracket

## What is required:



Power Drill  
(not provided)

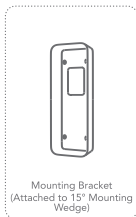

Mounting Bracket  
(Attached to 15° Mounting Wedge)

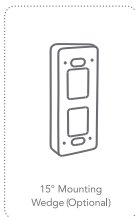

15° Mounting Wedge (Optional)

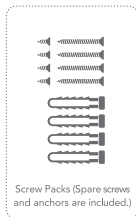

Screw Packs (Spare screws and anchors are included.)

### Step 3 Mounting the Doorbell

Mount the Doorbell

Align the doorbell on top and then snap it on the bottom.

Press it down until it clicks into place.

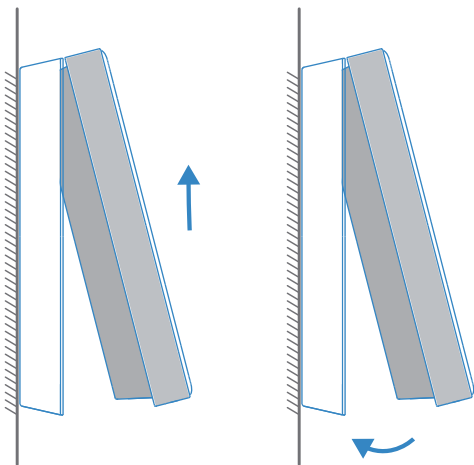

You're all set!

If you want to detach the doorbell or recharge it, please refer to the following sections.

## Detach the Doorbell

1. Use the doorbell detaching pin provided if you wish to detach the doorbell from the Mounting Bracket.
2. Press and hold the hole on the bottom of the doorbell and then lift its bottom to take it off.

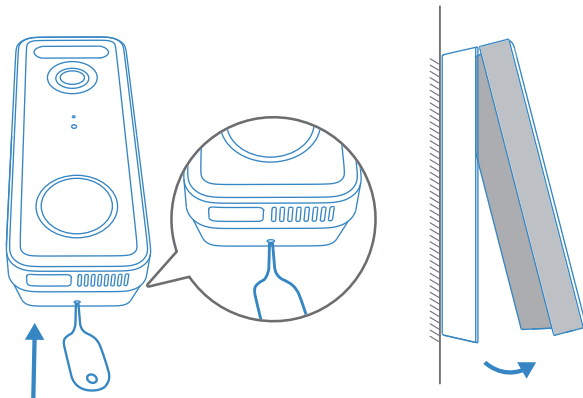

### What is required:



## Recharge the Doorbell

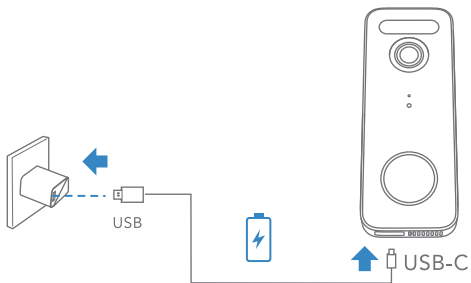

LED indication	Charging: The blue light flashes
	Fully charged: Solid blue
Charging time	6 hours from 0% to 100%

## Option 2 - Doorbell Wire Powered

1. If you have existing and working doorbell wiring at the front door, the doorbell will be powered by the wires constantly. So you don't need to detach and charge it after installation.
2. Since the doorbell is connected to the wires, the mounting position is limited.
3. If you choose this option, please jump to Appendix 2 Powering the Doorbell with Doorbell Wires.

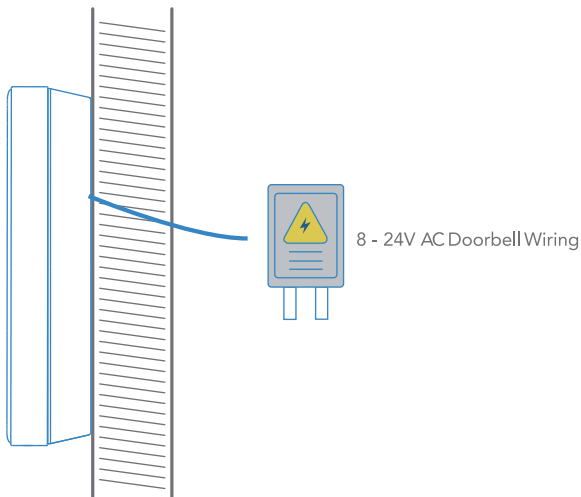

## Step 1 Verify whether the doorbell wires are working

1. Ring the existing doorbell to check if it is working. If the doorbell doesn't ring, your doorbell wires may be defective. Power the doorbell on its own battery or consult an electrician to fix the wires.
2. Shut off power at the breaker. Turn the lights on / off in your home to make sure the electricity in your house is properly shut off.

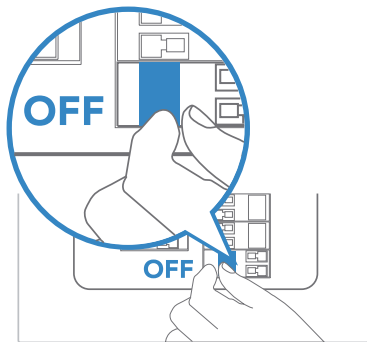

Note: Always be careful when handling electricity wiring. If you're not comfortable to do it yourself, do consult a qualified electrician.



## Step 2 Detach the Existing Doorbell Button

If you already have existing doorbell wiring:

1. Remove the existing doorbell button with a Phillips-Head screwdriver.
2. Pull the two wires out carefully when removing the existing doorbell.  
Straighten the wire ends if necessary.

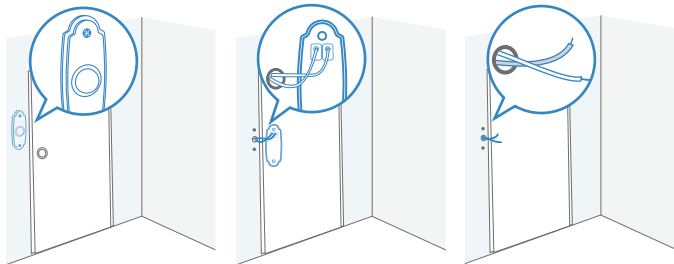

### What is required:



### Step 3 Find a Mounting Spot

1. Determine the mounting position of the doorbell. Consider the below factors:

- Check if you can reuse the existing holes and anchors on the wall or door frame.
- If you are drilling the mounting holes for the first time, the recommended mounting height is 48" / 1.2 m from the ground.
- Use the 15° mounting wedge as a supplementary mounting bracket if you wish to see more on a specific side.

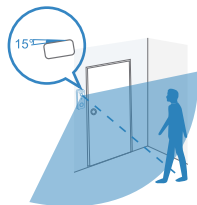
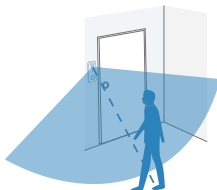
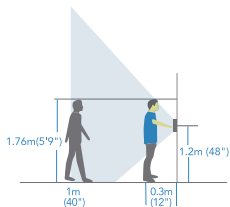

2. Place the Screw Hole Positioning Card against the wall to mark the position.

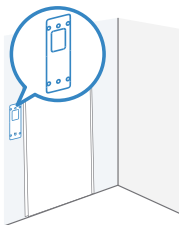

## Step 4 Mount the Bracket

If you're mounting the doorbell on a wooden surface, you don't need to pre-drill pilot holes. Use the provided screws to secure the Mounting Bracket on the wall. The Screw Hole Positioning Card indicates the position of the screw holes.

Without 15° Mounting Wedge

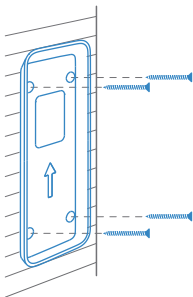

Mounting Bracket

With 15° Mounting Wedge

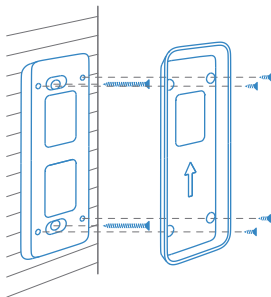

Mounting Wedge

Mounting Bracket

## What is required:



Phillips-Head Screwdriver

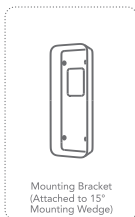

Mounting Bracket  
(Attached to 15°  
Mounting Wedge)

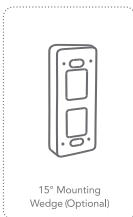

15° Mounting  
Wedge (Optional)

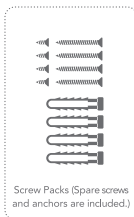

Screw Packs (Spare screws  
and anchors are included.)

If you're mounting the doorbell on a surface made out of hard materials, like brick, concrete, stucco:

- Drill 2 holes through the Screw Hole Positioning Card with 15/64" (6mm) drill bit.
- Insert the provided anchors, and then use the provided long screws to secure the Mounting Bracket on the wall.

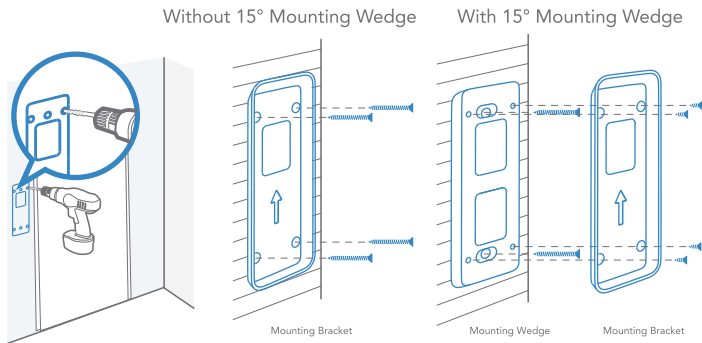

## What is required:

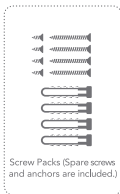
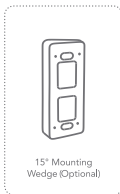
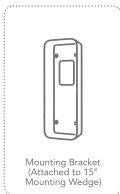
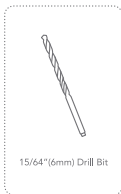

## Step 5 Connect the Doorbell Wires to the Doorbell

Connect the wires to the terminals at the back of the doorbell, then tighten the terminal screws. Wire can connect to any terminal.

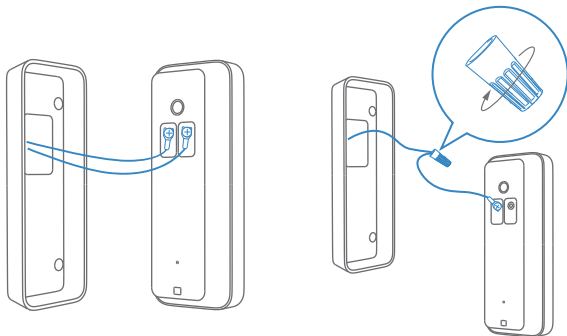

Note:

- To prevent short-circuit, make sure the wires are not touching each other after connecting them to the terminals.
- If the wires are too short, use the extension wires and wire nuts provided to make them longer. Use electrical wiring tape instead if there is no more space on the wall for wire nuts.

### What is required:



## Step 6 Mount the Doorbell on the Bracket

Align the doorbell on top and then snap it on the bottom.

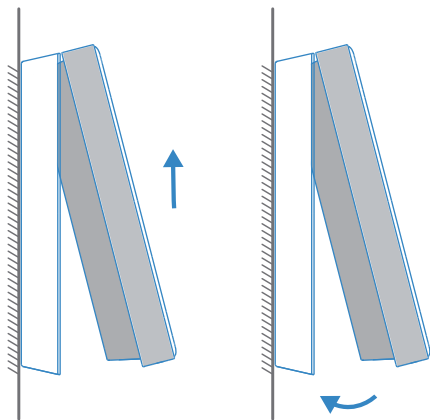

## Step 7 Restore Power

Switch the master circuit breaker back to ON.  
You're all set!

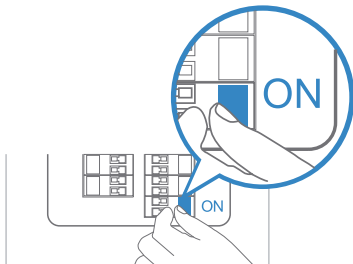

# Notice

---

## **FCC Statement**

This device complies with Part 15 of the FCC Rules. Operation is subject to the following two conditions: (1) this device may not cause harmful interference, and (2) this device must accept any interference received, including interference that may cause undesired operation.

Warning: Changes or modifications not expressly approved by the party responsible for compliance could void the user's authority to operate the equipment. Note: This equipment has been tested and found to comply with the limits for a Class B digital device, pursuant to Part 15 of the FCC Rules. These limits are designed to provide reasonable protection against harmful interference in a residential installation.

This equipment generates uses and can radiate radio frequency energy and, if not installed and used in accordance with the instructions, may cause harmful interference to radio communications. However, there is no guarantee that interference will not occur in a particular installation. If this equipment does cause harmful interference to radio or television reception, which can be determined by turning the equipment off and on, the user is encouraged to try to correct the interference by one or more of the following measures: (1) Reorient or relocate the receiving antenna. (2) Increase the separation between the equipment and receiver. (3) Connect the equipment into an outlet on a circuit different from that to which the receiver is connected. (4) Consult the dealer or an experienced radio/ TV technician for help.

## **FCC Radio Frequency Exposure Statement**

The device has been evaluated to meet general RF exposure requirements. The device can be used in fixed/mobile exposure condition. The min separation distance is 20cm. Notice: Shielded cables

All connections to other computing devices must be made using shielded cables to maintain compliance with FCC regulations.



This product complies with the radio interference requirements of the European Community.

## Declaration of Conformity

Hereby, Glazero Limited declares that this device is in compliance with the essential requirements and other relevant provisions of Directive 2014/53/EU. For the declaration of conformity, visit the Web site:<https://www.aosulife.com/>. This product can be used across EU member states.

Do not use the Device in the environment at too high or too low temperature, never expose the Device under strong sunshine or too wet environment. The suitable temperature for HomeBase and accessories is -10°C-45°C. The suitable temperature for Video Doorbell and accessories is -20°C - 40°C .

When charging, please place the device in an environment that has a normal room temperature and good ventilation.

It is recommended to charge the device in an environment with a temperature that ranges from 5°C~25°C.

RF exposure information: The Maximum Permissible Exposure (MPE) level has been calculated based on a distance of  $d=20$  cm between the device and the human body. To maintain compliance with RF exposure requirement, use product that maintain a 20cm distance between the device and human body. For HomeBase: Wi-Fi Operating Frequency Range: 2412~2472MHz ; Wifi Max Output

Power: 17.36dBm(EIRP)

Wi-Fi Operating Frequency Range: 5150MHz~5250MHz ; Wifi Max Output Power: 9.99dBm(EIRP)

Wi-Fi Operating Frequency Range: 5725MHz~5875MHz ; Wifi Max Output Power: 12.26dBm(EIRP)

For Video Doorbell: Wi-Fi Operating Frequency Range: 2412~2472MHz ; Wifi Max Output

Power: 15.53dBm(EIRP)





This product is designed and manufactured with high quality materials and components, which can be recycled and reused.



This symbol means the product must not be discarded as household waste, and should be delivered to an appropriate collection facility for recycling. Proper disposal and recycling helps protect natural resources, human health and the environment. For more information on disposal and recycling of this product, contact your local municipality, disposal service, or the shop where you bought this product



### **Battery warning**

- Replacement of a battery with an incorrect type that can defeat a safeguard (for example, in the case of some lithium battery types).
- Disposal of a battery into fire or a hot oven, or mechanically crushing or cutting of a battery, that can result in an explosion.
- Leaving a battery in an extremely high temperature surrounding environment that can result in an explosion or the leakage of flammable liquid or gas.
- A battery subjected to extremely low air pressure that may result in an explosion or the leakage of flammable liquid or gas.

# Customer Service

---

## Warranty

12-month limited warranty

## Email Us

Customer Support: [support@aosulife.com](mailto:support@aosulife.com)



**Facebook:** @aosulife



**Twitter:** @aosulife



**YouTube:** @aosulife

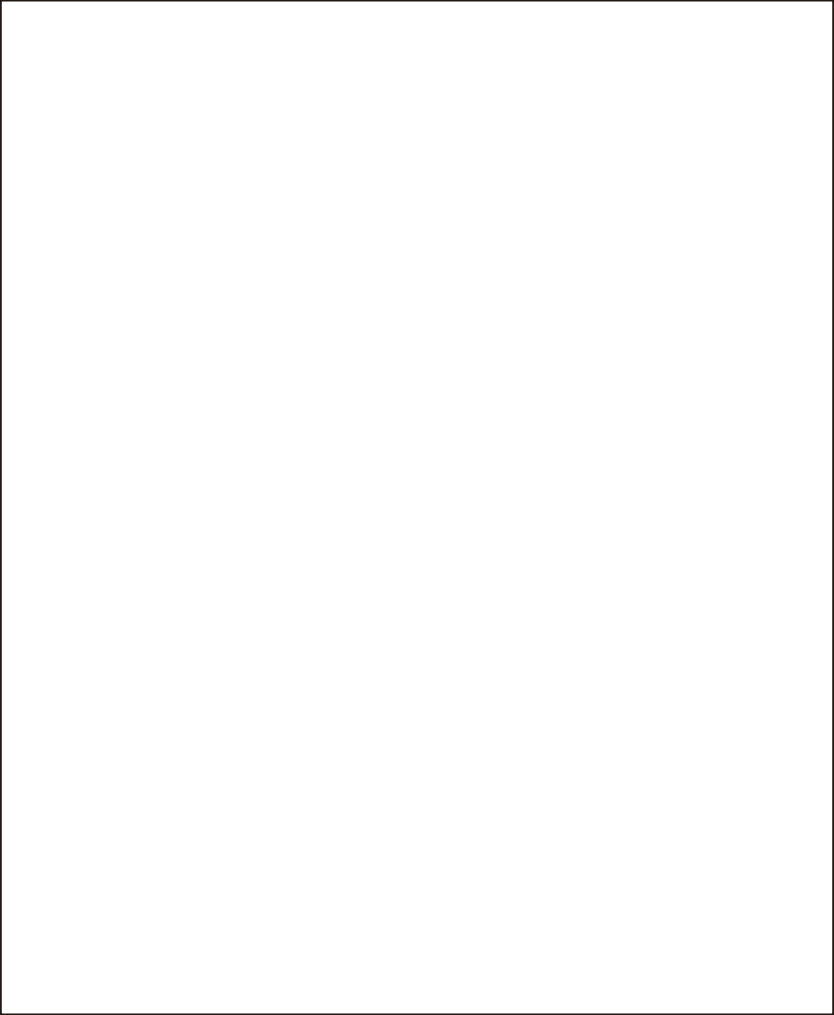

QOSU