

## 说明书制作要求

材质:105g哑粉

成品尺寸:167x115mm,共20P

印刷:CMYK

装订方式:骑马钉,按照顺序装订

备注:请使用ai文档印刷

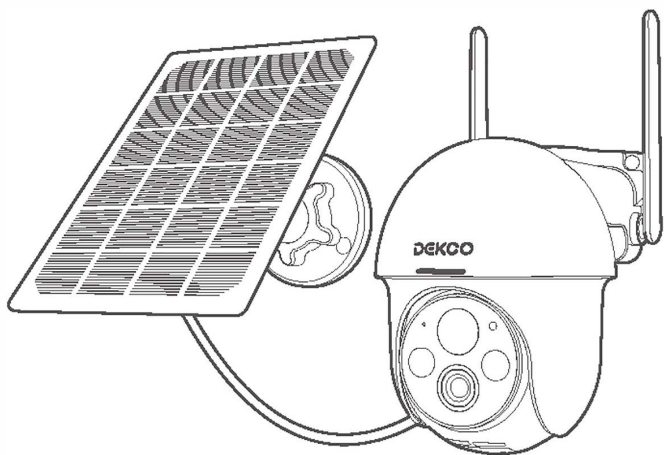

[www.dekcolife.com](http://www.dekcolife.com)



[support@dekcolife.com](mailto:support@dekcolife.com)



@DEKCOLIFE



US: 1-877-277-5797 UK: 44-20-3885-0802



## DekcoCare

Hi Customer

Thank you for choosing DEKCO security products. We have always put our customers first and foremost.

There are 3 things you should know before using this product:

### 1. Micro SD card

If you don't have a Micro-SD card available at home now and don't want to spend extra time choosing one, please contact us directly. TIP: the Micro-SD card gotta be formatted after inserting it up.

### 2. Select 2.4G wifi

The product only supports 2.4G wifi, please select 2.4G wifi when setting up the app.

### 3. Select installation location.

Please use your mobile phone to test the coverage of the home wifi signal at the planned installation position before installation, so that the product can receive a better signal.

Get all the tutorial videos of using product including but no limit to set up the app, installation and format micro sd card, visit: [dekcolife.com/DekcoCare](http://dekcolife.com/DekcoCare)

Join "DekcoCare" today as three ways below to get all of your problems solved by one-on-one live chat and phone service tech support.



[www.dekcolife.com](http://www.dekcolife.com)



[support@dekcolife.com](mailto:support@dekcolife.com)



[@DEKCOLIFE](https://www.facebook.com/DEKCOLIFE)



US: 1-877-277-5797 UK: 44-20-3885-0802

# TABLE OF CONTENTS

- 01** What's Included P01
- 02** Product overview P02
- 03** App installation and Setup P03
- 04** Mounting the camera P04-06
- 05** Register an account P07
- 06** Set up WiFi for the camera P08-13
- 07** FAQ P14
- 08** Safety Statement P15

## What's Included



Camera

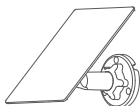

Solar panels

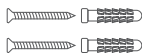

Screw Pack



Sticker



Warning Sticker



User Manual



Micro-USB  
Charging Cable

## Product overview

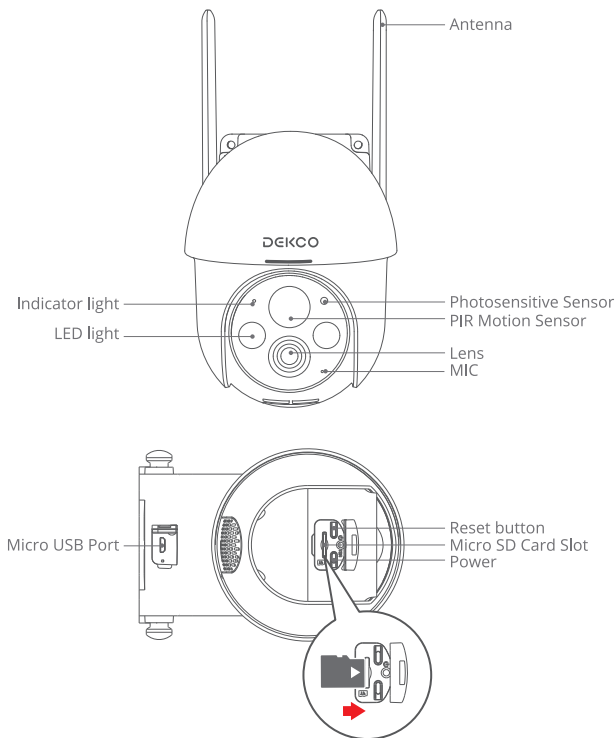

**CAUTION:** Please insert the Micro SD Card according to the direction shown in the diagram. Micro SD Card might JAM if inserted incorrectly and device could be damaged.

**SD Card Port:** Support micro SD card for local storage (Max 128GB).

**Reset button:** Used to restore the camera to factory settings (Press and hold on 5-8s).

**Card capacity requirements:** 8-128GB.

**Read and write speed requirements:** class10 level.

**File format:** FAT32.

## CloudEdge App installation and Setup

Search " CloudEdge" on apple store or google play to download the app.

- from Google Play
- from Apple Store





## Mounting the camera

### Select Height and location

Hang dekoCam 7-10ft (78-118 inch) above the ground. This height maximizes the detection range of the motion sensor of dekoCam. Avoid placing dekoCam under direct sunlight.

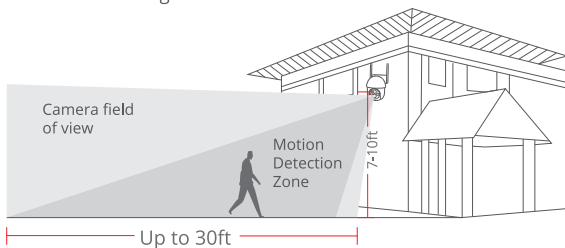

### Installation

1. Drilling according to position sticker, drill bit: 15/64"(6 mm).
2. Insert the plugs.
3. Tighten the screw.

### What is required:

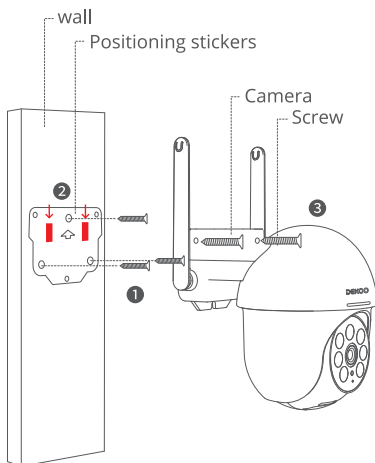

## Installation instruction of solar panel

1. keep the installation angle of solar panels about 30-45° with the horizontal plane, as shown in the picture below.
2. The installation between the solar panel and the camera is shown in the following figure(open up the silicone cover at the bottom of the camera, remove the small center part of the cover, insert the power cord through the opening and plug it into the USB port and then close the cover taking up any slack in the power cord from the solar panel).

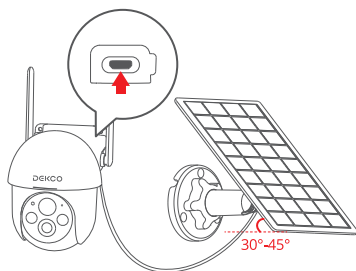

## Tips for the installation of solar panel

1. When installing in the northern hemisphere, face the panel to the south, and when installing in the southern hemisphere, face the panel to the north.
2. Take care to install the solar panel so that the sun is not blocked by any items such as eaves, trees branches, etc.

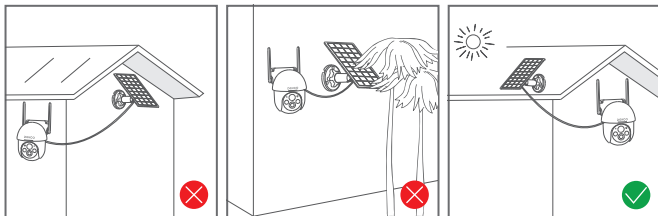

## Test the Wifi signal at installation position

Use cell phone to test Wifi signal quality at the installation position before installing camera, make sure the Wifi router can provide good Wifi signal.

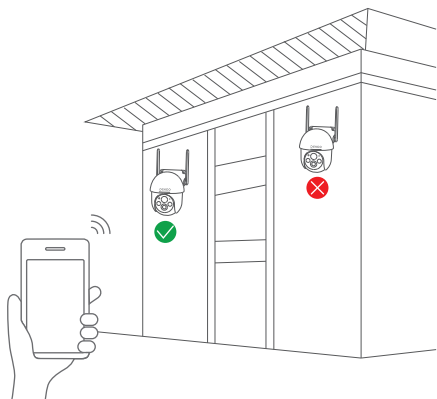

## Register an account

The CloudEdge app that is necessary to operate the camera. Signing up for storage in the cloud is totally optional and is really not necessary when using an onboard Micro SD card.

1. Open the APP to sign up an account. Go to the login interface, and click "Sign Up".
2. Sign up with your email address, and click "Next".
3. Set up an "Nickname" and "Password" for your APP, click "Done" to complete.

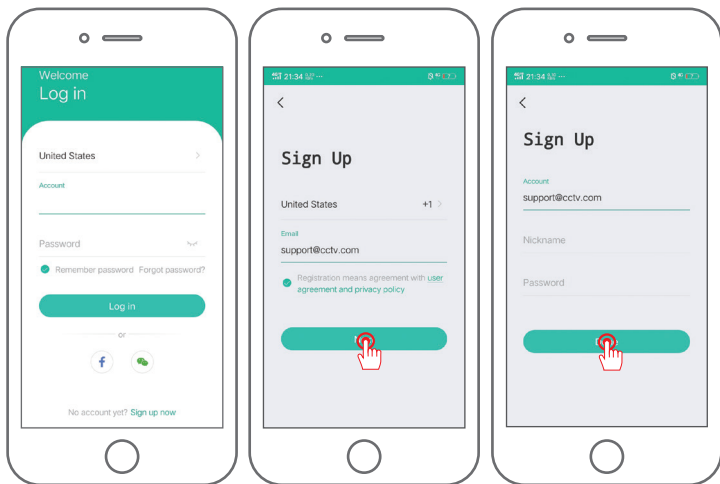

1

2

3

## Set up WiFi for the camera

1. Bring both your mobile phone and your DEKCO camera close to your router (max distance of 5 meters/16 feet).

Note: The DEKCO camera can only connect to a 2.4 GHz WiFi signal. It does not support using a 5 GHz signal. Therefore, please ensure you connect to a 2.4 GHz signal on your network as shown in the below illustration.

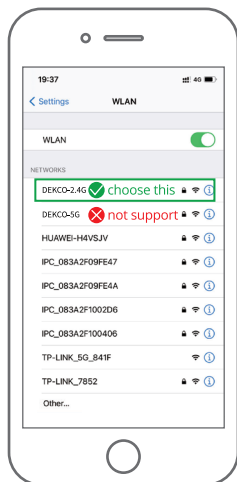
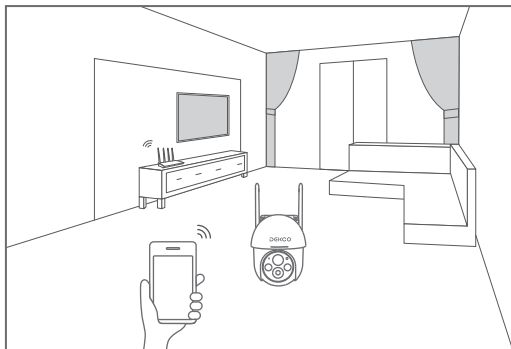

2. Log in to “CloudEdge”, then tap the “+” icon in the center. Tap “Battery Camera” to add device.

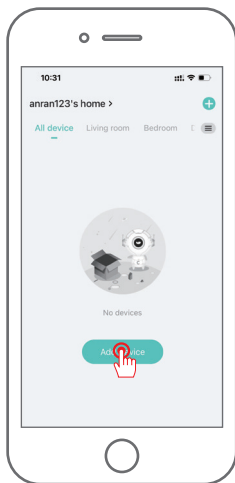

2-1

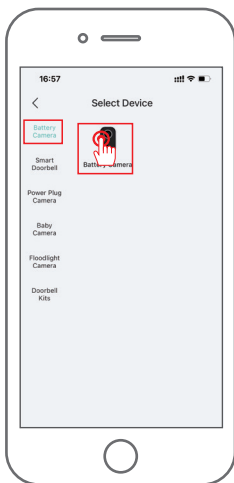

2-2

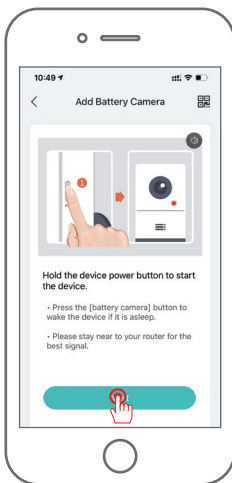

2-3

3. Reset the device and wait for a flashing RED indicator light, then tap "Next".

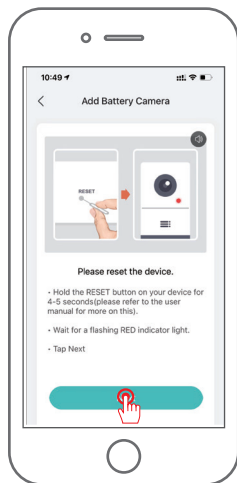

3

4. Selecting the Wi-Fi the device needs to connected with (your home Wi-Fi), input the password and click "Next".

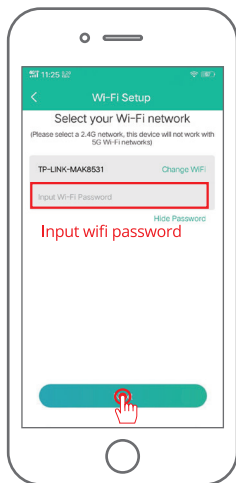

4-1

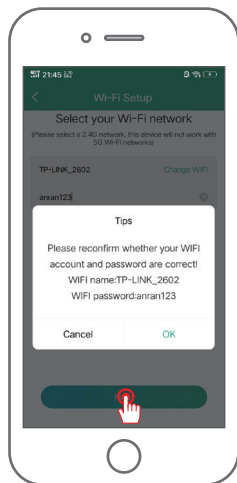

4-2



5. Use the DEKCO camera to scan the QR code on your mobile phone as noted below. When the scan is complete you will hear a prompt tone then push Next.

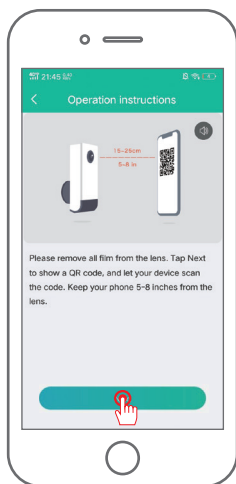

5-1



5-2

6. When connecting, as stated earlier, you should make sure that the router, mobile phone and the DEKCO camera and are as close together as possible (max 5 meters/16 feet). When a successful connection occurs a "click" will be heard and a checkmark will be noted as shown below. The DEKCO camera will show with a numerical name that can be changed to your likings such as Driveway Camera, Street View Camera or whatever.

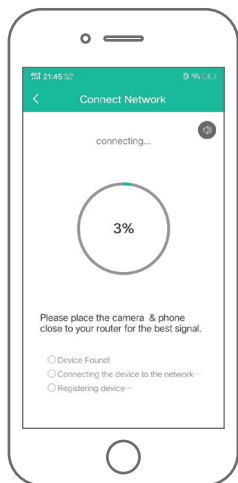

6-1

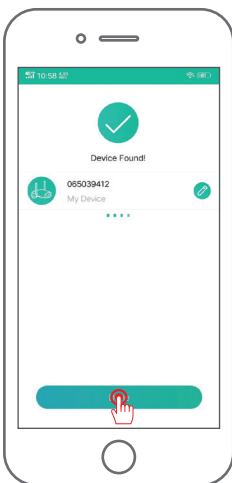

6-2

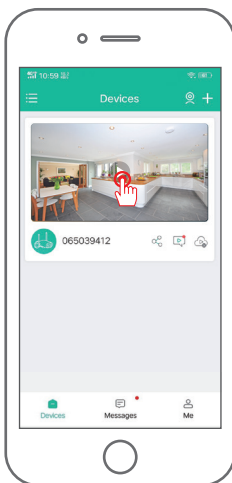

6-3

## FAQ

**Q:** The device cannot be previewed properly?

**A:** Check whether the network is normal, you can place the camera close to the router, and if not, it is recommended to reset the device and add it again.

**Q:** Why is it still in the list of devices after resetting?

**A:** The reset device only resets the network configuration of the camera, but cannot change the configuration on the App, remove the camera, and must be deleted by the App.

**Q:** How to "connect" the camera to another router?

**A:** First remove and reset the device on the App and then configure the device again by the App.

**Q:** Why doesn't the device identify the SD card?

**A:** It is recommended that the SD card be inserted when the power to the camera is off and that it is fully inserted correctly. Make sure the SD card has been formatted with FAT 32. If not, this can be done via the CloudEdge app.

**Q:** Why can't I receive notifications via the mobile phone's app?

**A:** Please confirm that the App has been running on the phone, and the relevant reminder function has been opened; Message notification and authority confirmation in the mobile phone system have been opened.

## Safety Statement

### FCC Statement

This device complies with Part 15 of the FCC Rules. Operation is subject to the following two conditions: (1) this device may not cause harmful interference, and (2) this device must accept any interference received, including interference that may cause undesired operation.

Warning: Changes or modifications not expressly approved by the party responsible for compliance could void the user's authority to operate the equipment.

Note: This equipment has been tested and found to comply with the limits for a Class B digital device, pursuant to Part 15 of the FCC Rules. These limits are designed to provide reasonable protection against harmful interference in a residential installation.

This equipment generates uses and can radiate radio frequency energy and, if not installed and used in accordance with the instructions, may cause harmful interference to radio communications. However, there is no guarantee that interference will not occur in a particular installation. If this equipment does cause harmful interference to radio or television reception, which can be determined by turning the equipment off and on, the user is encouraged to try to correct the interference by one or more of the following measures: (1) Reorient or relocate the receiving antenna. (2) Increase the separation between the equipment and receiver. (3) Connect the equipment into an outlet on a circuit different from that to which the receiver is connected. (4) Consult the dealer or an experienced radio/ TV technician for help.

### FCC Radio Frequency Exposure Statement

The device has been evaluated to meet general RF exposure requirements. The device can be used in fixed/mobile exposure condition. The min separation distance is 20cm.

Notice: Shielded cables

All connections to other computing devices must be made using shielded cables to maintain compliance with FCC regulations.

DEKCO