

AOSU

Solar-Powered Wireless Security Camera & Spotlight

SolarCam D1 Max

Quick Start Guide

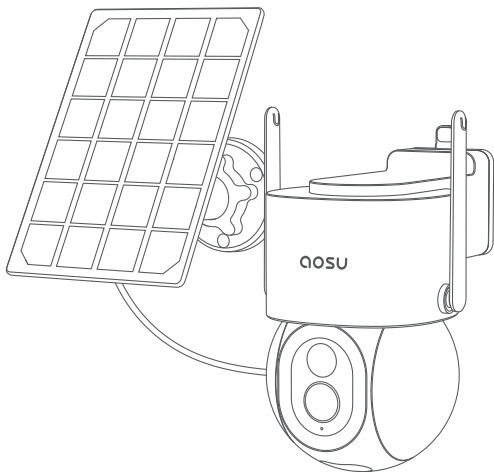

United States: +1-866-905-9950 Mon-Fri 9AM-5PM(PST)

United Kingdom: +44-20-3885-0830 Mon-Fri 9AM-5PM(GMT)

Germany: +49-32-221094692 Mon-Fri 9AM-5PM(CET)

Japan: +81-50-5840-2601 Mon-Fri 9AM-5PM(JST)



support@aosulife.com



www.aosulife.com



@aosulife

Aosu Care

Hi Customer

Thank you for choosing Aosu security products. We have always put our customers first and foremost.

There are 3 things you should know before using this product:

1. Micro SD Card

If you don't have a Micro SD Card available at home now and don't want to spend extra time choosing one, please contact us directly.

TIP: the Micro SD Card gotta be formatted after inserting it up.

2. Select 2.4G Wi-Fi

The product only supports 2.4G Wi-Fi, please select 2.4G Wi-Fi when setting up the app.

3. Select installation location.

Please use your mobile phone to test the coverage of the home Wi-Fi signal at the planned installation position before installation, so that the product can receive a better signal.

Get all the tutorial videos of using product including but no limit to set up the app, installation and format micro sd card, **visit:**

aosulife.com

Join "Aosu Care" today as three ways below to get all of your problems solved by one-on-one live chat and phone service tech support.



United States: +1-866-905-9950 Mon-Fri 9AM-5PM(PST)

United Kingdom: +44-20-3885-0830 Mon-Fri 9AM-5PM(GMT)

Germany: +49-32-221094692 Mon-Fri 9AM-5PM(CET)

Japan: +81-50-5840-2601 Mon-Fri 9AM-5PM (JST)



support@aosulife.com



www.aosulife.com



@aosulife

TABLE OF CONTENTS

01	What's Included	P01
02	Product Overview	P02
03	Setting Up the System	P03
04	Mounting the Camera	P04-12
05	Notice	P13-P15
06	Customer Service	P16

What's Included

SolarCam D1 Max

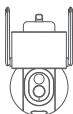

Camera
(C9S2CH11)

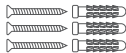

Screw Pack



USB-C Charging
Cable



Mounting Bracket



Security Sticker



Quick Start Guide



Position Sticker

Solar Panel



Solar Panel



Universal Joint



Socket nut



Locking
Screw Cap



Base



Mounting Screws
and Anchors

Product overview

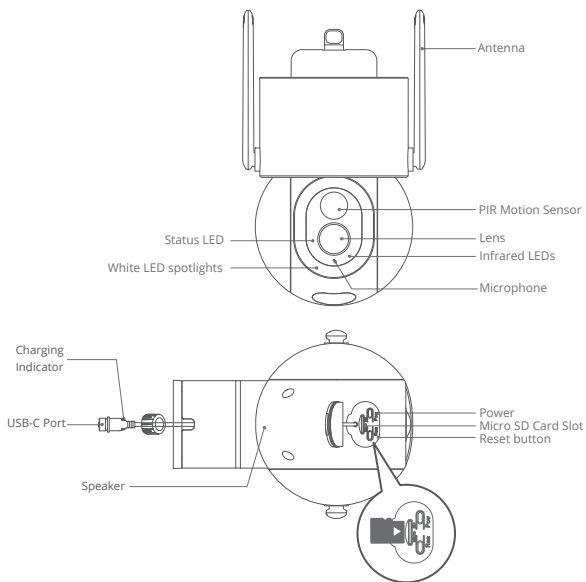

CAUTION: Please insert the Micro SD Card according to the direction shown in the diagram. Micro SD Card might JAM if inserted incorrectly and device could be damaged.

Micro SD Card Port: Support Micro SD Card for local storage (Max 128GB).

Reset button: Press and hold the button for 3 seconds, and then the device will be ready to be connected.

Card capacity requirements: 8-128GB.

Read and write speed requirements: class10 level.

File format: FAT32.

Setting Up the System

Download the Aosu App from the App Store (iOS devices) or Google Play (Android devices).



Sign up for an Aosu App account, then follow the onscreen instructions to complete the setup.

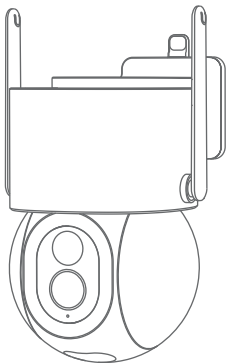

Mounting the Camera

Find a Good Mounting Spot

To find a spot to mount Camera, you need to test wireless signal strength.

- ① Open the **aosu App**, go to Camera Settings > Mounting Guide.
- ② To test the wireless signal strength, take your camera and phone to the location where you want to mount the camera.
- ③ Move the camera as close to the Wi-Fi Router as possible to get a better signal.

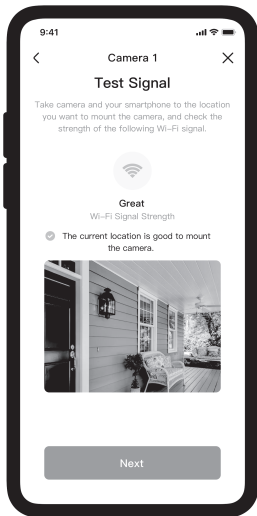

Select Height and location

Hang Camera 2-3meters above the ground. This height maximizes the detection range of the motion sensor of Camera. Avoid placing Camera under direct sunlight.

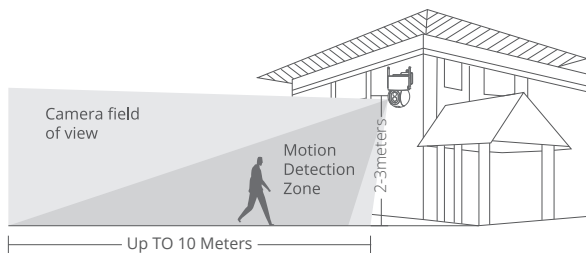

Installation instruction of solar panel

1. keep the installation angle of solar panels about 30° - 45° with the horizontal plane, as shown in the picture below.
2. The installation between the solar panel and the camera is shown in the following figure (open up the silicone cover at the bottom of the camera, remove the small center part of the cover, insert the power cord through the opening and plug it into the USB-C Port and then close the cover taking up any slack in the power cord from the solar panel).

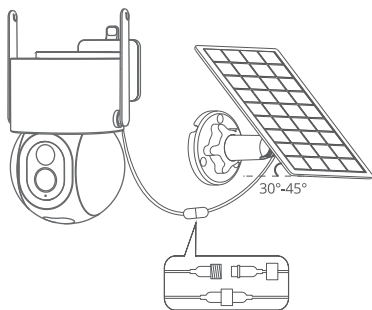

Tips for the installation of solar panel

1. When installing in the northern hemisphere, face the panel to the south, and when installing in the southern hemisphere, face the panel to the north.
2. Take care to install the solar panel so that the sun is not blocked by any items such as eaves, trees branches, etc.

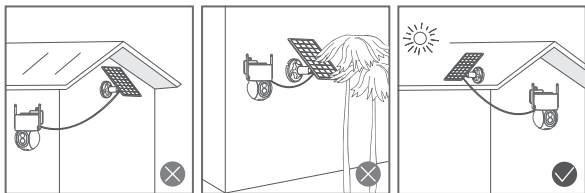

Test the Wi-Fi signal at installation position

Use cell phone to test Wi-Fi signal quality at the installation position before installing camera, make sure the Wi-Fi router can provide good Wi-Fi signal.

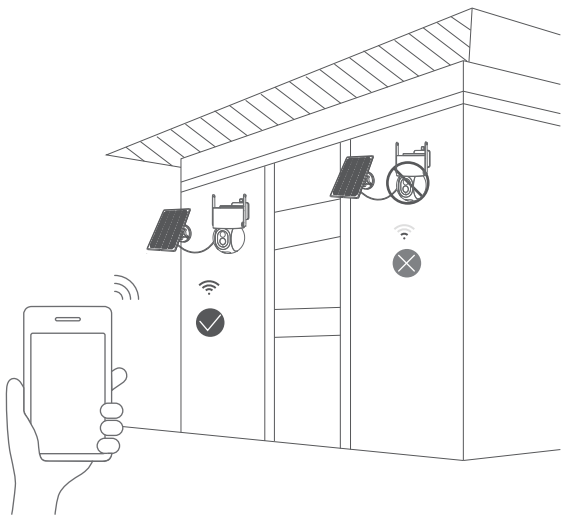

Installation

1. Drilling according to position sticker, drill bit: 15/64"(6 mm).
2. Insert the plugs.
3. Tighten the screws.

What is required:

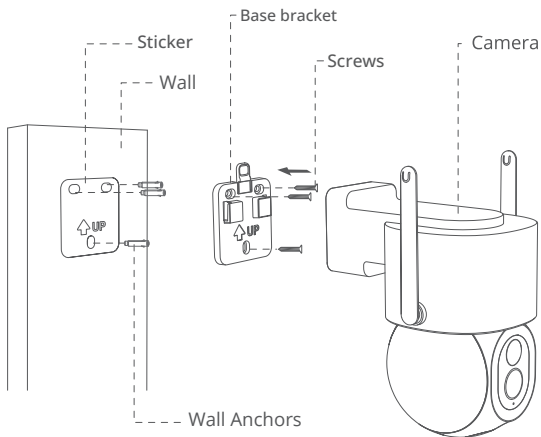

Installation instruction of solar panel

Place Solar Panel in an area with consistent sunlight throughout the year. It only needs a few hours of direct sunlight each day to keep your camera powered.

The amount of energy that the solar panel produces is affected by weather conditions, seasonal changes, geographic location, etc.

1. Fix the base to your mounting location using the included screws. If the installation surface is soft or unstable, first use a ϕ 6.0 drill bit to drill a hole in the wall, then insert the anchor nail into the hole, and fix the base with screws.

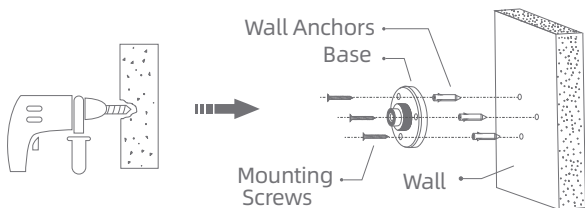

2. First, install the locking screw cap into the universal joint and then screw the circular socket nut into the universal joint.



3. Screw the universal joint into the back of the solar panel. Tighten it firmly with the attached nut.

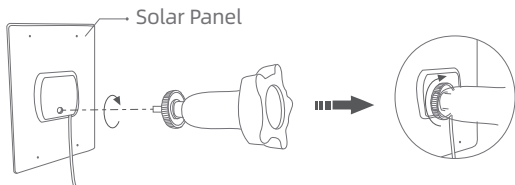

4. Screw the locking screw cap into the base. Make sure that the universal joint is angled upward.

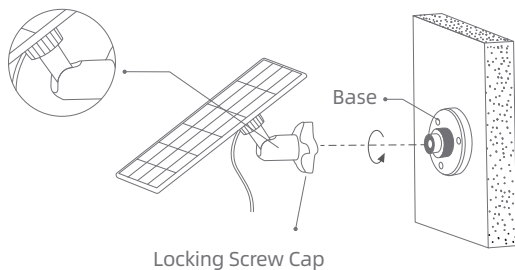

5. When adjusting the solar panel left or right, loosen the locking screw cap, turn the sleeve rod, and tighten the locking screw cap when the panel is in position.

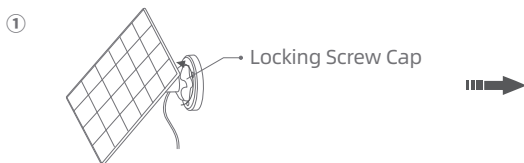

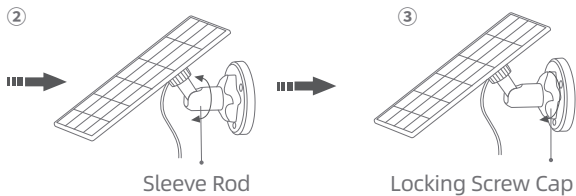

6. Solar panel's angle can be adjusted up and down up to 90°.

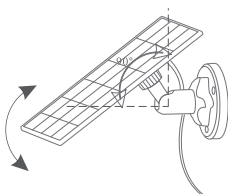

Tip: After the installation is complete, please check that all locking mechanisms are tightly secured.

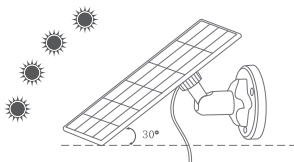

Notice

FCC Statement

This device complies with Part 15 of the FCC Rules. Operation is subject to the following two conditions: (1) this device may not cause harmful interference, and (2) this device must accept any interference received, including interference that may cause undesired operation.

Warning: Changes or modifications not expressly approved by the party responsible for compliance could void the user's authority to operate the equipment. Note: This equipment has been tested and found to comply with the limits for a Class B digital device, pursuant to Part 15 of the FCC Rules. These limits are designed to provide reasonable protection against harmful interference in a residential installation.

This equipment generates uses and can radiate radio frequency energy and, if not installed and used in accordance with the instructions, may cause harmful interference to radio communications. However, there is no guarantee that interference will not occur in a particular installation. If this equipment does cause harmful interference to radio or television reception, which can be determined by turning the equipment off and on, the user is encouraged to try to correct the interference by one or more of the following measures: (1) Reorient or relocate the receiving antenna. (2) Increase the separation between the equipment and receiver. (3) Connect the equipment into an outlet on a circuit different from that to which the receiver is connected. (4) Consult the dealer or an experienced radio/ TV technician for help.

FCC Radio Frequency Exposure Statement

The device has been evaluated to meet general RF exposure requirements.

The device can be used in fixed/mobile exposure condition. The min separation distance between the radiator and your body is 20cm.



This product complies with the radio interference requirements of the European Community.

Declaration of Conformity

Hereby, Aosu declares that this device is in compliance with the essential requirements and other relevant provisions of Directive 2014/53/EU.

For the declaration of conformity, visit the Web site:<https://www.aosulife.com>.

This product can be used across EU member states.

Do not use the Device in the environment at too high or too low temperature, never expose the Device under strong sunshine or too wet environment.

The suitable temperature for Camera and accessories is -10°C — 50°C .

RF exposure information: The Maximum Permissible Exposure (MPE) level has been calculated based on a distance of $d=20$ cm between the device and the human body. To maintain compliance with RF exposure requirement, use product that maintain a 20cm distance between the device and human body.

For Camera : Wi-Fi Operating Frequency Range: 2412~2472MHz ; Wi-Fi Max Output Power: 17.13dBm(EIRP)



This product is designed and manufactured with high quality materials and components, which can be recycled and reused.



This symbol means the product must not be discarded as household waste, and should be delivered to an appropriate collection facility for recycling. Proper disposal and recycling helps protect natural resources, human health and the environment. For more information on disposal and recycling of this product, contact your local municipality, disposal service, or the shop where you bought this product.

IC Statement

This device contains licence-exempt transmitter(s)/receiver(s) that comply with Innovation, Science and Economic Development Canada's licence-exempt RSS(s). Operation is subject to the following two conditions: (1) This device may not cause interference. (2) This device must accept any interference, including interference that may cause undesired operation of the device.

L'émetteur/récepteur exempt de licence contenu dans le présent appareil est conforme aux CNR d'Innovation, Sciences et Développement économique Canada applicables aux appareils radio exempts de licence. L'exploitation est autorisée aux deux conditions suivantes : (1) L'appareil ne doit pas produire de brouillage; (2) L'appareil doit accepter tout brouillage radioélectrique subi, même si le brouillage est susceptible d'en compromettre le fonctionnement.

IC RF Statement

This equipment complies with IC RSS - 102 radiation exposure limits set forth for an uncontrolled environment. This equipment should be installed and operated with minimum distance 20cm between the radiator and your body.

Cet équipement est conforme aux limites d'exposition aux radiations IC CNR - 102 établies pour un environnement non contrôlé. Cet équipement doit être installé et utilisé avec une distance minimale de 20 cm entre le radiateur et votre corps.

Customer Service

Warranty

12-month limited warranty(The actual warranty period shall be implemented according to the requirements of local laws and regulations)

Email Us

Customer Support: support@aosulife.com

Call Us

United States: +1-866-905-9950 Mon-Fri 9AM-5PM(PST)

United Kingdom: +44-20-3885-0830 Mon-Fri 9AM-5PM(GMT)

Germany: +49-32-221094692 Mon-Fri 9AM-5PM(CET)

Japan: +81-50-5840-2601 Mon-Fri 9AM-5PM (JST)



Facebook: [@aosulife](#)



Twitter: [@aosulife](#)



YouTube: [@aosulife](#)

nosu