

# aosU

## 5MP UHD Wi-Fi Security Camera & Spotlight

### Security Cam D1 SE

#### Quick Start Guide

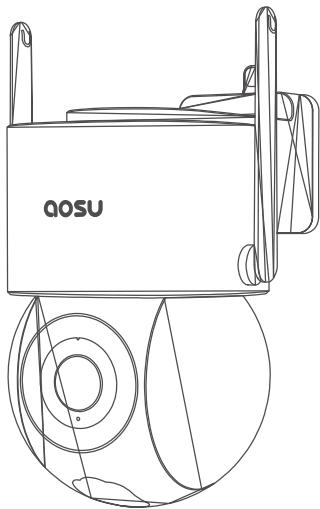

United States: +1-866-905-9950 Mon-Fri 9AM-5PM (PST)

United Kingdom: +44-20-3885-0830 Mon-Fri 9AM-5PM (GMT)

Germany: +49-32-221094692 Mon-Fri 9AM-5PM (CET)

Japan: +81-50-5840-2601 Mon-Fri 9AM-5PM (JST)



[www.aosulife.com](http://www.aosulife.com)



[@aosulife](https://www.facebook.com/aosulife)



[support@aosulife.com](mailto:support@aosulife.com)

# AOSUCare

---

Hi Customer

Thank you for choosing AOSU security products. We have always put our customers first and foremost.

There are 3 things you should know before using this product :

## 1. Micro SD Card

If you don't have a Micro SD Card available at home now and don't want to spend extra time choosing one, please contact us directly. TIP: the Micro SD Card gotta be formatted after inserting it up.

## 2. Select 2.4G Wi-Fi

The product only supports 2.4G Wi-Fi, please select 2.4G Wi-Fi when setting up the app.

## 3. Select installation location

Please use your mobile phone to test the coverage of the home Wi-Fi signal at the planned installation position before installation, so that the product can receive a better signal.

Get all the tutorial videos of using product including but no limit to set up the app, installation and format micro sd card, visit: [aosulife.com](http://aosulife.com)

Join "AOSUCare" today as three ways below to get all of your problems solved by one-on-one live chat and phone service tech support.

# TABLE OF CONTENTS

01	What's Included	P01
02	Product Overview	P02
03	Setting Up the System	P03
04	Mounting the Security Camera	P04-07
05	Notice	P08-P10
06	Customer Service	P11

# What's Included

---

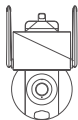

Camera



Screw Pack



Power Adapter



Sticker



Quick Start Guide

# Product Overview

---

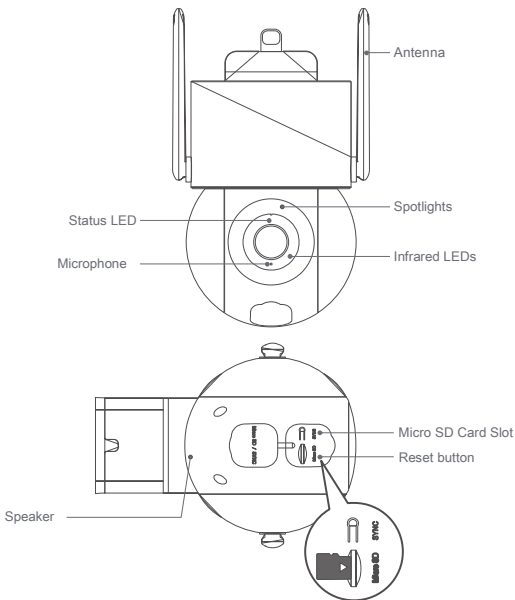

**CAUTION:** Please insert the Micro SD Card according to the direction shown in the diagram. Micro SD Card might JAM if inserted incorrectly and device could be damaged.

SD Card Port: Support Micro SD Card for local storage (Max 512GB).

Reset button: Press and hold the button for 3 seconds, and then the device will be ready to be connected.

Card capacity requirements: 8-512GB.

Read and write speed requirements: class10 level.

File format: FAT32.

## Setting Up the System

---

Download the Aosu App from the App Store (iOS devices) or Google Play (Android devices).

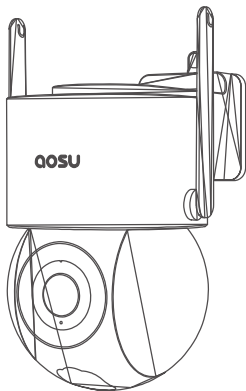

# Mounting the Security Camera

## Find a Good Mounting Spot

To find a spot to mount OutdoorCam D1 Lite, you need to test wireless signal strength.

- ① Open the Aosu App, go to Camera Settings > Mounting Guide.
- ② To test the wireless signal strength, take your camera and phone to the location where you want to mount the camera.
- ③ Move the camera as close to the Wi-Fi Router as possible to get a better signal.

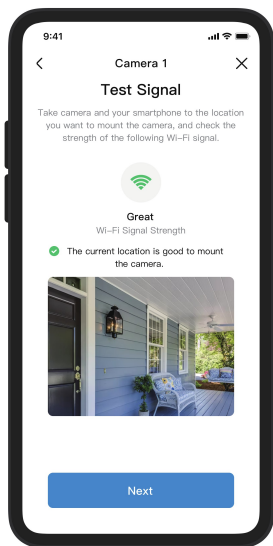

## Select Height and Location

Hang Security Camera 7-10ft (78-118 inches) above the ground. This height maximizes the detection range of the motion sensor of Security Camera. Avoid placing AOSUCam under direct sunlight.

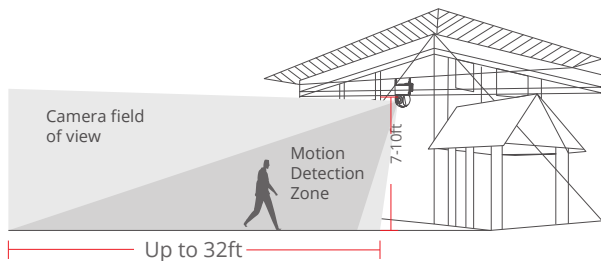



## Test the Wifi signal at installation position

Use cell phone to test Wifi signal quality at the installation position before installing camera, make sure the Wifi router can provide good Wifi signal.



## Installation

1. Drilling according to position sticker, drill bit: 15/64"(6 mm).
2. Insert the plugs.
3. Tighten the screws.

### What is required:

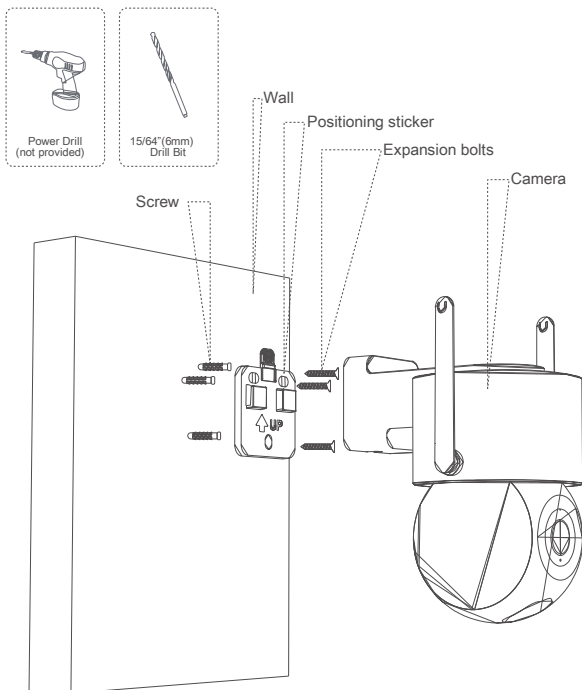

## Notice

---

### FCC Statement

This device complies with Part 15 of the FCC Rules. Operation is subject to the following two conditions: (1) this device may not cause harmful interference, and (2) this device must accept any interference received, including interference that may cause undesired operation.

Warning: Changes or modifications not expressly approved by the party responsible for compliance could void the user's authority to operate the equipment. Note: This equipment has been tested and found to comply with the limits for a Class B digital device, pursuant to Part 15 of the FCC Rules. These limits are designed to provide reasonable protection against harmful interference in a residential installation.

This equipment generates uses and can radiate radio frequency energy and, if not installed and used in accordance with the instructions, may cause harmful interference to radio communications. However, there is no guarantee that interference will not occur in a particular installation. If this equipment does cause harmful interference to radio or television reception, which can be determined by turning the equipment off and on, the user is encouraged to try to correct the interference by one or more of the following measures: (1) Reorient or relocate the receiving antenna. (2) Increase the separation between the equipment and receiver. (3) Connect the equipment into an outlet on a circuit different from that to which the receiver is connected. (4) Consult the dealer or an experienced radio/ TV technician for help.

### FCC Radio Frequency Exposure Statement

The device has been evaluated to meet general RF exposure requirements.

The device can be used in fixed/mobile exposure condition. The min separation distance between the radiator and your body is 20cm.



This product complies with the radio interference requirements of the European Community.

### Declaration of Conformity

Hereby, Aosu declares that this device is in compliance with the essential requirements and other relevant provisions of Directive 2014/53/EU.

For the declaration of conformity, visit the Web site: <https://www.aosulife.com>.

This product can be used across EU member states.

Do not use the Device in the environment at too high or too low temperature, never expose the Device under strong sunshine or too wet environment.

The suitable temperature for OutdoorCam and accessories is -20°C- 50°C.

RF exposure information: The Maximum Permissible Exposure (MPE) level has been calculated based on a distance of  $d=20\text{cm}$  between the device and the human body. To maintain compliance with RF exposure requirement, use product that maintain a 20cm distance between the device and human body.

For OutdoorCam: Wi-Fi Operating Frequency Range: 2412~2472MHz ; Wifi Max Output Power: 16.64 dBm(EIRP)



This product is designed and manufactured with high quality materials and components, which can be recycled and reused.



This symbol means the product must not be discarded as household waste, and should be delivered to an appropriate collection facility for recycling. Proper disposal and recycling helps protect natural resources, human health and the environment. For more information on disposal and recycling of this product, contact your local municipality, disposal service, or the shop where you bought this product.

### ISED Warning

This device complies with Innovation, Science, and Economic Development Canada licence-exempt RSS standard(s). Operation is subject to the following two conditions: (1) this device may not cause interference, and (2) this device must accept any interference, including interference that may cause undesired operation of the device.

Le présent appareil est conforme aux CNR d' Innovation, Sciences et Développement économique Canada applicables aux appareils radio exempts de licence. L'exploitation est autorisée aux deux conditions suivantes : (1) l'appareil ne doit pas produire de brouillage, et (2) l'utilisateur de l'appareil doit accepter tout brouillage radioélectrique subi, même si le brouillage est susceptible d'en compromettre le fonctionnement.

Radiation Exposure Statement: The equipment complies with ISED radiation exposure limits set forth for an uncontrolled environment. The equipment should be installed and operated with minimum distance 20cm between the radiator & your body.

Déclaration d'exposition aux radiations: L'équipement est conforme aux limites d'exposition aux rayonnements ISED fixées pour un environnement non contrôlé. L'équipement doit être installé et utilisé avec une distance minimale de 20cm entre le radiateur et votre corps

# Customer Service

---

## Warranty

12-month limited warranty (The actual warranty period shall be implemented according to the requirements of local laws and regulations )

## Email Us

Customer Support: [support@aosulife.com](mailto:support@aosulife.com)

## Call Us

United States: +1-866-905-9950 Mon-Fri 9AM-5PM (PST)

United Kingdom: +44-20-3885-0830 Mon-Fri 9AM-5PM (GMT)

Germany: +49-32-221094692 Mon-Fri 9AM-5PM (CET)

Japan: +81-50-5840-2601 Mon-Fri 9AM-5PM (JST)



Facebook: [@aosulife](#)



Twitter: [@aosulife](#)



YouTube: [@aosulife](#)

QOSU