

TEST REPORT

Applicant: ShenZhen FLYSKY Technology Co.,Ltd

Address of Applicant: 16F, Huafeng Building, No. 6006 Shennan Road, Futian District, Shenzhen, Guangdong, China

Manufacturer: ShenZhen FLYSKY Technology Co.,Ltd

Address of Manufacturer: 16F, Huafeng Building, No. 6006 Shennan Road, Futian District, Shenzhen, Guangdong, China

Factory: Dongguan Flysky RC Model technology Co.,Ltd

Address of Factory: West building 3, HuangjinyuanInd Park, Qiaoli North Gate, Changping Town, Dongguan, China

Equipment Under Test (EUT)

Product Name: 2.4GHz 8 CHANNEL RECEIVER

Model No.: Tr8B

Trade Mark: FLYSKY

FCC ID: 2A2UNTR8B00

Applicable standards: FCC CFR Title 47 Part 15 Subpart C Section 15.247

Date of sample receipt: March 10, 2022

Date of Test: March 11-29, 2022

Date of report issued: March 29, 2022

Test Result : PASS *

* In the configuration tested, the EUT complied with the standards specified above.

Authorized Signature:



Robinson Luo
Laboratory Manager

This results shown in this test report refer only to the sample(s) tested, this test report cannot be reproduced, except in full, without prior written permission of the company. The report would be invalid without specific stamp of test institute and the signatures of compiler and approver.

2 Version

Version No.	Date	Description
00	March 29, 2022	Original

Prepared By:

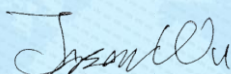

Date:

March 29, 2022

Project Engineer

Check By:

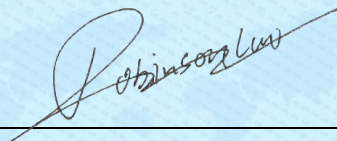

Date:

March 29, 2022

Reviewer

3 Contents

Page

1	COVER PAGE	1
2	VERSION	2
3	CONTENTS	3
4	TEST SUMMARY	4
4.1	MEASUREMENT UNCERTAINTY	4
5	GENERAL INFORMATION	5
5.1	GENERAL DESCRIPTION OF EUT	5
5.2	TEST MODE	8
5.3	TEST FACILITY.....	8
5.4	TEST LOCATION	8
5.5	DESCRIPTION OF SUPPORT UNITS	8
5.6	DEVIATION FROM STANDARDS.....	8
5.7	ABNORMALITIES FROM STANDARD CONDITIONS	8
5.8	ADDITIONAL INSTRUCTIONS.....	8
6	TEST INSTRUMENTS LIST	9
7	TEST RESULTS AND MEASUREMENT DATA.....	11
7.1	ANTENNA REQUIREMENT	11
7.2	CONDUCTED EMISSIONS	12
7.3	CONDUCTED PEAK OUTPUT POWER	15
7.4	20dB EMISSION BANDWIDTH	16
7.5	CARRIER FREQUENCIES SEPARATION.....	17
7.6	HOPPING CHANNEL NUMBER	18
7.7	DWELL TIME.....	19
7.8	SPURIOUS EMISSION IN NON-RESTRICTED & RESTRICTED BANDS	20
7.8.1	Conducted Emission Method.....	20
7.8.2	Radiated Emission Method.....	21
8	TEST SETUP PHOTO	43
9	EUT CONSTRUCTIONAL DETAILS	43

4 Test Summary

Test Item	Section	Result
Antenna Requirement	15.203/15.247 (c)	Pass
AC Power Line Conducted Emission	15.207	Pass
Conducted Peak Output Power	15.247 (b)(1)	Pass
20dB Occupied Bandwidth	15.247 (a)(1)	Pass
Carrier Frequencies Separation	15.247 (a)(1)	Pass
Hopping Channel Number	15.247 (a)(1)(iii)	Pass
Dwell Time	15.247 (a)(1)(iii)	Pass
Radiated Emission	15.205/15.209	Pass
Band Edge	15.247(d)	Pass

Pass: The EUT complies with the essential requirements in the standard.

Remark : Test according to ANSI C63.10:2013.

4.1 Measurement Uncertainty

Test Item	Frequency Range	Measurement Uncertainty	Notes
Radiated Emission	9kHz-30MHz	3.1dB	(1)
Radiated Emission	30MHz-200MHz	3.8039dB	(1)
Radiated Emission	200MHz-1GHz	3.9679dB	(1)
Radiated Emission	1GHz-18GHz	4.29dB	(1)
Radiated Emission	18GHz-40GHz	3.30dB	(1)
AC Power Line Conducted Emission	0.15MHz ~ 30MHz	3.44dB	(1)

Note (1): The measurement uncertainty is for coverage factor of k=2 and a level of confidence of 95%.

5 General Information

5.1 General Description of EUT

Product Name:	2.4GHz 8 CHANNEL RECEIVER
Model No.:	Tr8B
Serial No.:	N/A
Hardware version:	Tr8B-V1.1
Software version:	Tr8B V1.0.1
Test sample(s) ID:	GTS202203000167-1
Sample(s) Status	Engineer sample
Operation Frequency:	2402.15MHz~2479.85MHz
Channel numbers:	171
Modulation method:	FHSS
Modulation technology:	GMSK
Antenna Type:	ANT 1&2: Integral Antenna
Antenna gain:	ANT 1&2: -1dBi
Power supply:	DC 3.5-9.0V

Remark: All two antennas transmitters were work in asynchronous status, MIMO mode is not supported .

The system works in the frequency range of 2402.15MHz to 2479.85MHz. This band has been divided to 171 independent channels. Each radio system uses 32 different channels; the minimum channel separation is ≥ 0.595 MHz. By using various switch-on times, hopping scheme and channel frequencies, the system can guarantee a jamming free radio transmission. Pre-testing all radio systems, this radio system recorded in the report is the worst mode. The channel list is below.

The test frequencies are below:

Channel	Frequency
The lowest channel	2402.15MHz
The middle channel	2440.4MHz
The Highest channel	2479.85MHz

Operation Frequency each of channel							
Channel	Frequency (MHz)	Channel	Frequency (MHz)	Channel	Frequency (MHz)	Channel	Frequency (MHz)
1	2402.15	44	2421.5	87	2440.85	130	2461.4
2	2402.6	45	2421.95	88	2441.3	131	2461.85
3	2403.05	46	2422.4	89	2441.75	132	2462.3
4	2403.5	47	2422.85	90	2442.2	133	2462.75
5	2403.95	48	2423.3	91	2442.65	134	2463.2
6	2404.4	49	2423.75	92	2443.1	135	2463.65
7	2404.85	50	2424.2	93	2444.75	136	2464.1
8	2405.3	51	2424.65	94	2445.2	137	2464.55
9	2405.75	52	2425.1	95	2445.65	138	2465
10	2406.2	53	2425.55	96	2446.1	139	2465.45
11	2406.65	54	2426	97	2446.55	140	2465.9
12	2407.1	55	2426.45	98	2447	141	2466.35
13	2407.55	56	2426.9	99	2447.45	142	2466.8
14	2408	57	2427.35	100	2447.9	143	2467.25
15	2408.45	58	2427.8	101	2448.35	144	2467.7
16	2408.9	59	2428.25	102	2448.8	145	2468.15
17	2409.35	60	2428.7	103	2449.25	146	2468.6
18	2409.8	61	2429.15	104	2449.7	147	2469.05
19	2410.25	62	2429.6	105	2450.15	148	2469.5
20	2410.7	63	2430.05	106	2450.6	149	2469.95
21	2411.15	64	2430.5	107	2451.05	150	2470.4
22	2411.6	65	2430.95	108	2451.5	151	2470.85
23	2412.05	66	2431.4	109	2451.95	152	2471.3
24	2412.5	67	2431.85	110	2452.4	153	2471.75
25	2412.95	68	2432.3	111	2452.85	154	2472.2
26	2413.4	69	2432.75	112	2453.3	155	2472.65
27	2413.85	70	2433.2	113	2453.75	156	2473.1
28	2414.3	71	2433.65	114	2454.2	157	2473.55
29	2414.75	72	2434.1	115	2454.65	158	2474
30	2415.2	73	2434.55	116	2455.1	159	2474.45
31	2415.65	74	2435	117	2455.55	160	2474.9
32	2416.1	75	2435.45	118	2456	161	2475.35
33	2416.55	76	2435.9	119	2456.45	162	2475.8
34	2417	77	2436.35	120	2456.9	163	2476.25
35	2417.45	78	2436.8	121	2457.35	164	2476.7
36	2417.9	79	2437.25	122	2457.8	165	2477.15
37	2418.35	80	2437.7	123	2458.25	166	2477.6
38	2418.8	81	2438.15	124	2458.7	167	2478.05

39	2419.25	82	2438.6	125	2459.15	168	2478.5
40	2419.7	83	2439.05	126	2459.6	169	2478.95
41	2420.15	84	2439.5	127	2460.05	170	2479.4
42	2420.6	85	2439.95	128	2460.5	171	2479.85
43	2421.05	86	2440.4	129	2460.95		

5.2 Test mode

Transmitting mode	Keep the EUT in transmitting mode.
Remark: During the test, the duty cycle >98%, the test voltage is adjusted from DC3.5V to DC9.0V, and found that the worst case was DC9.0V. So the report just shows that condition's data.	

5.3 Test Facility

<p>The test facility is recognized, certified, or accredited by the following organizations:</p> <ul style="list-style-type: none"> ● FCC —Registration No.: 381383 Designation Number: CN5029 Global United Technology Services Co., Ltd., Shenzhen EMC Laboratory has been registered and fully described in a report filed with the (FCC) Federal Communications Commission. The acceptance letter from the FCC is maintained in files. ● IC —Registration No.: 9079A CAB identifier: CN0091 The 3m Semi-anechoic chamber of Global United Technology Services Co., Ltd. has been registered by Certification and Engineering Bureau of Industry Canada for radio equipment testing. ● NVLAP (LAB CODE:600179-0) Global United Technology Services Co., Ltd., is accredited by the National Voluntary Laboratory Accreditation Program (NVLAP).
--

5.4 Test Location

All other tests were performed at:
<p>Global United Technology Services Co., Ltd. Address: No. 123-128, Tower A, Jinyuan Business Building, No.2, Laodong Industrial Zone, Xixiang Road, Baoan District, Shenzhen, Guangdong, China 518102 Tel: 0755-27798480 Fax: 0755-27798960</p>

5.5 Description of Support Units

Manufacturer	Description	Model	Serial Number
ShenZhen FLYSKY Technology Co.,Ltd	Remote control	FT18	N/A
GW	DC POWER SUPPLY	GPR-6030D	EF924756

5.6 Deviation from Standards

None.

5.7 Abnormalities from Standard Conditions

None.

5.8 Additional Instructions

Software (Used for test) from client
Built-in by manufacturer, power set default.

6 Test Instruments list

Radiated Emission:						
Item	Test Equipment	Manufacturer	Model No.	Inventory No.	Cal.Date (mm-dd-yy)	Cal.Due date (mm-dd-yy)
1	3m Semi- Anechoic Chamber	ZhongYu Electron	9.2(L)*6.2(W)* 6.4(H)	GTS250	July. 02 2020	July. 01 2025
2	Control Room	ZhongYu Electron	6.2(L)*2.5(W)* 2.4(H)	GTS251	N/A	N/A
3	EMI Test Receiver	Rohde & Schwarz	ESU26	GTS203	June. 24 2021	June. 23 2022
4	BiConiLog Antenna	SCHWARZBECK MESS-ELEKTRONIK	VULB9163	GTS214	June. 24 2021	June. 23 2022
5	Double -ridged waveguide horn	SCHWARZBECK MESS-ELEKTRONIK	BBHA 9120 D	GTS208	June. 24 2021	June. 23 2022
6	Horn Antenna	ETS-LINDGREN	3160	GTS217	June. 24 2021	June. 23 2022
7	EMI Test Software	AUDIX	E3	N/A	N/A	N/A
8	Coaxial Cable	GTS	N/A	GTS213	June. 24 2021	June. 23 2022
9	Coaxial Cable	GTS	N/A	GTS211	June. 24 2021	June. 23 2022
10	Coaxial cable	GTS	N/A	GTS210	June. 24 2021	June. 23 2022
11	Coaxial Cable	GTS	N/A	GTS212	June. 24 2021	June. 23 2022
12	Amplifier(100kHz-3GHz)	HP	8347A	GTS204	June. 24 2021	June. 23 2022
13	Amplifier(2GHz-20GHz)	HP	84722A	GTS206	June. 24 2021	June. 23 2022
14	Amplifier (18-26GHz)	Rohde & Schwarz	AFS33-18002 650-30-8P-44	GTS218	June. 24 2021	June. 23 2022
15	Band filter	Amindeon	82346	GTS219	June. 24 2021	June. 23 2022
16	Power Meter	Anritsu	ML2495A	GTS540	June. 24 2021	June. 23 2022
17	Power Sensor	Anritsu	MA2411B	GTS541	June. 24 2021	June. 23 2022
18	Wideband Radio Communication Tester	Rohde & Schwarz	CMW500	GTS575	June. 24 2021	June. 23 2022
19	Splitter	Agilent	11636B	GTS237	June. 24 2021	June. 23 2022
20	Loop Antenna	ZHINAN	ZN30900A	GTS534	June. 24 2021	June. 23 2022
21	Breitband hornantenne	SCHWARZBECK	BBHA 9170	GTS579	Oct. 17 2021	Oct. 16 2022
22	Amplifier	TDK	PA-02-02	GTS574	Oct. 17 2021	Oct. 16 2022
23	Amplifier	TDK	PA-02-03	GTS576	Oct. 17 2021	Oct. 16 2022
24	PSA Series Spectrum Analyzer	Rohde & Schwarz	FSP	GTS578	June. 24 2021	June. 23 2022

Conducted Emission						
Item	Test Equipment	Manufacturer	Model No.	Inventory No.	Cal.Date (mm-dd-yy)	Cal.Due date (mm-dd-yy)
1	Shielding Room	ZhongYu Electron	7.3(L)x3.1(W)x2.9(H)	GTS252	May.15 2019	May.14 2022
2	EMI Test Receiver	R&S	ESCI 7	GTS552	June. 24 2021	June. 23 2022
3	Coaxial Switch	ANRITSU CORP	MP59B	GTS225	June. 24 2021	June. 23 2022
4	ENV216 2-L-V-NETZNACHB.DE	ROHDE&SCHWARZ	ENV216	GTS226	June. 24 2021	June. 23 2022
5	Coaxial Cable	GTS	N/A	GTS227	N/A	N/A
6	EMI Test Software	AUDIX	E3	N/A	N/A	N/A
7	Thermo meter	KTJ	TA328	GTS233	June. 24 2021	June. 23 2022
8	Absorbing clamp	Elektronik-Feinmechanik	MDS21	GTS229	June. 24 2021	June. 23 2022
9	ISN	SCHWARZBECK	NTFM 8158	GTS565	June. 24 2021	June. 23 2022
10	High voltage probe	SCHWARZBECK	TK9420	GTS537	July. 09 2021	July. 08 2022

RF Conducted Test:						
Item	Test Equipment	Manufacturer	Model No.	Serial No.	Cal.Date (mm-dd-yy)	Cal.Due date (mm-dd-yy)
1	MXA Signal Analyzer	Agilent	N9020A	GTS566	June. 24 2021	June. 23 2022
2	EMI Test Receiver	R&S	ESCI 7	GTS552	June. 24 2021	June. 23 2022
3	Spectrum Analyzer	Agilent	E4440A	GTS533	June. 24 2021	June. 23 2022
4	MXG vector Signal Generator	Agilent	N5182A	GTS567	June. 24 2021	June. 23 2022
5	ESG Analog Signal Generator	Agilent	E4428C	GTS568	June. 24 2021	June. 23 2022
6	USB RF Power Sensor	DARE	RPR3006W	GTS569	June. 24 2021	June. 23 2022
7	RF Switch Box	Shongyi	RFSW3003328	GTS571	June. 24 2021	June. 23 2022
8	Programmable Constant Temp & Humi Test Chamber	WEWON	WHTH-150L-40-880	GTS572	June. 24 2021	June. 23 2022

General used equipment:						
Item	Test Equipment	Manufacturer	Model No.	Inventory No.	Cal.Date (mm-dd-yy)	Cal.Due date (mm-dd-yy)
1	Humidity/ Temperature Indicator	KTJ	TA328	GTS243	June. 24 2021	June. 23 2022
2	Barometer	ChangChun	DYM3	GTS255	June. 24 2021	June. 23 2022

7 Test results and Measurement Data

7.1 Antenna requirement

Standard requirement:	FCC Part15 C Section 15.203 /247(c)
<p>15.203 requirement:</p> <p>An intentional radiator shall be designed to ensure that no antenna other than that furnished by the responsible party shall be used with the device. The use of a permanently attached antenna or of an antenna that uses a unique coupling to the intentional radiator, the manufacturer may design the unit so that a broken antenna can be replaced by the user, but the use of a standard antenna jack or electrical connector is prohibited.</p> <p>15.247(c) (1)(i) requirement:</p> <p>(i) Systems operating in the 2400-2483.5 MHz band that is used exclusively for fixed. Point-to-point operations may employ transmitting antennas with directional gain greater than 6dBi provided the maximum conducted output power of the intentional radiator is reduced by 1 dB for every 3 dB that the directional gain of the antenna exceeds 6dBi.</p>	
EUT Antenna:	
<p><i>The antenna is integral antenna, the best case gain of the antenna is -1dBi, reference to the appendix II for details.</i></p>	

7.2 Conducted Emissions

Test Requirement:	FCC Part15 C Section 15.207				
Test Method:	ANSI C63.10:2013				
Test Frequency Range:	150KHz to 30MHz				
Class / Severity:	Class B				
Receiver setup:	RBW=9KHz, VBW=30KHz, Sweep time=auto				
Limit:	Frequency range (MHz)	Limit (dBuV)			
			Quasi-peak	Average	
	0.15-0.5	66 to 56*	56 to 46*		
	0.5-5	56	46		
	5-30	60	50		
* Decreases with the logarithm of the frequency.					
Test setup:	<p>Remark E.U.T: Equipment Under Test LISN: Line Impedance Stabilization Network Test table height=0.8m</p>				
Test procedure:	<ol style="list-style-type: none"> 1. The E.U.T and simulators are connected to the main power through a line impedance stabilization network (L.I.S.N.). This provides a 50ohm/50uH coupling impedance for the measuring equipment. 2. The peripheral devices are also connected to the main power through a LISN that provides a 50ohm/50uH coupling impedance with 50ohm termination. (Please refer to the block diagram of the test setup and photographs). 3. Both sides of A.C. line are checked for maximum conducted interference. In order to find the maximum emission, the relative positions of equipment and all of the interface cables must be changed according to ANSI C63.10:2009 on conducted measurement. 				
Test Instruments:	Refer to section 6.0 for details				
Test mode:	Refer to section 5.2 for details				
Test environment:	Temp.:	25 °C	Humid.:	52%	Press.: 1012mbar
Test results:	Pass				

Measurement data

Pre-scan all test modes, found worst case at 2440.4MHz@ Ant 1, and so only show the test result of 2440.4MHz@ Ant 1

Line:

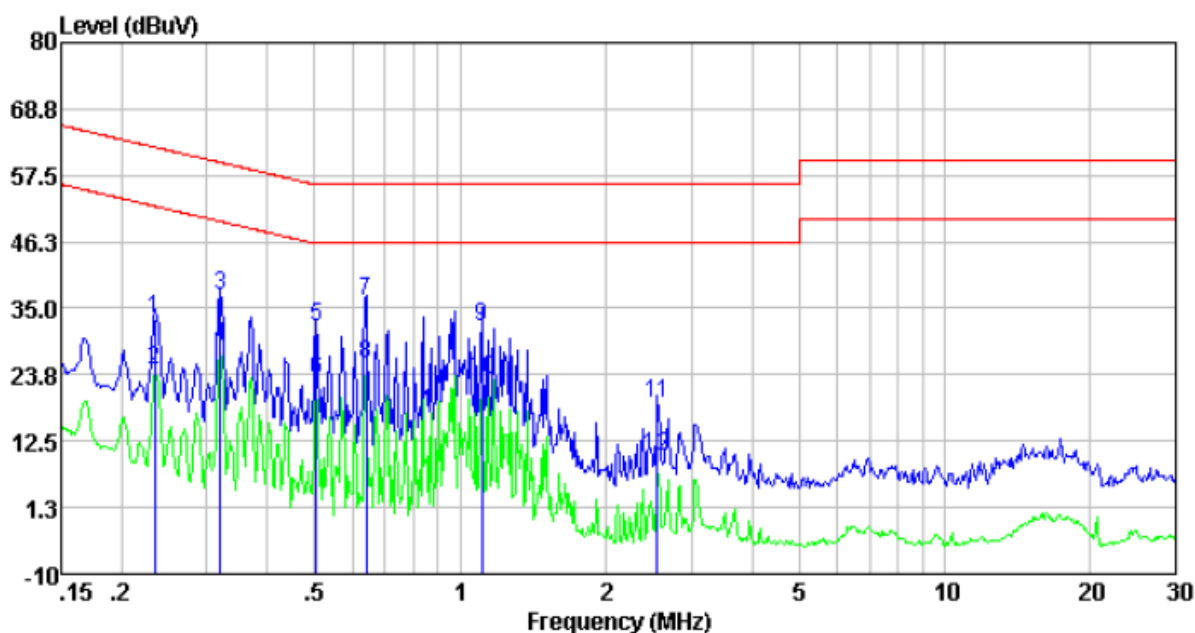

Freq	Reading level	LISM/ISN factor	Cable loss	Level	Limit level	Over limit	Remark
MHz	dBuV	dB	dB	dBuV	dBuV	dB	
0.23	22.74	10.40	0.01	33.15	62.30	-29.15	QP
0.23	14.18	10.40	0.01	24.59	52.30	-27.71	Average
0.32	26.86	10.39	0.01	37.26	59.71	-22.45	QP
0.32	18.02	10.39	0.01	28.42	49.71	-21.29	Average
0.50	21.48	10.31	0.01	31.80	56.00	-24.20	QP
0.50	12.62	10.31	0.01	22.94	46.00	-23.06	Average
0.64	25.97	10.27	0.02	36.26	56.00	-19.74	QP
0.64	15.08	10.27	0.02	25.37	46.00	-20.63	Average
1.11	21.76	10.20	0.03	31.99	56.00	-24.01	QP
1.11	12.64	10.20	0.03	22.87	46.00	-23.13	Average
2.55	8.71	10.20	0.05	18.96	56.00	-37.04	QP
2.55	-0.42	10.20	0.05	9.83	46.00	-36.17	Average

Neutral:

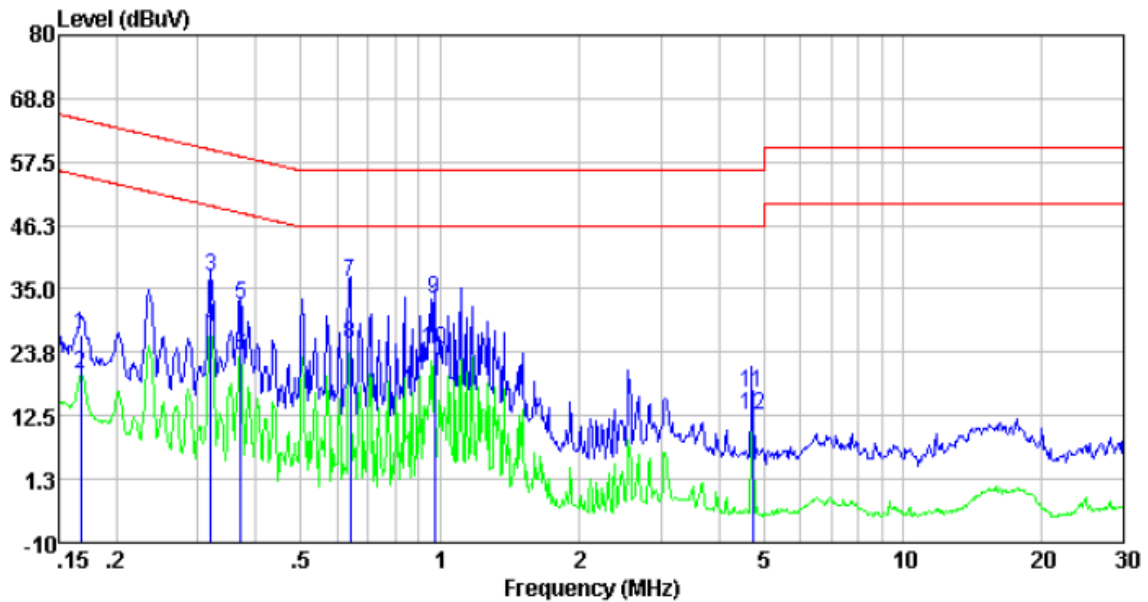

Freq	Reading level	LISN/ISN factor	Cable loss	Level	Limit level	Over limit	Remark
MHz	dBuV	dB	dB	dBuV	dBuV	dB	
0.17	16.45	10.40	0.01	26.86	65.08	-38.22	QP
0.17	9.42	10.40	0.01	19.83	55.08	-35.25	Average
0.32	26.79	10.39	0.01	37.19	59.71	-22.52	QP
0.32	17.92	10.39	0.01	28.32	49.71	-21.39	Average
0.37	21.71	10.36	0.01	32.08	58.47	-26.39	QP
0.37	12.85	10.36	0.01	23.22	48.47	-25.25	Average
0.64	25.90	10.27	0.02	36.19	56.00	-19.81	QP
0.64	14.87	10.27	0.02	25.16	46.00	-20.84	Average
0.97	22.79	10.20	0.03	33.02	56.00	-22.98	QP
0.97	13.88	10.20	0.03	24.11	46.00	-21.89	Average
4.73	6.20	10.20	0.06	16.46	56.00	-39.54	QP
4.73	2.30	10.20	0.06	12.56	46.00	-33.44	Average

Notes:

1. An initial pre-scan was performed on the line and neutral lines with peak detector.
2. Quasi-Peak and Average measurement were performed at the frequencies with maximized peak emission.
3. Final Level = Receiver Read level + LISN Factor + Cable Loss
4. If the average limit is met when using a quasi-peak detector receiver, the EUT shall be deemed to meet both limits and measurement with the average detector receiver is unnecessary.

7.3 Conducted Peak Output Power

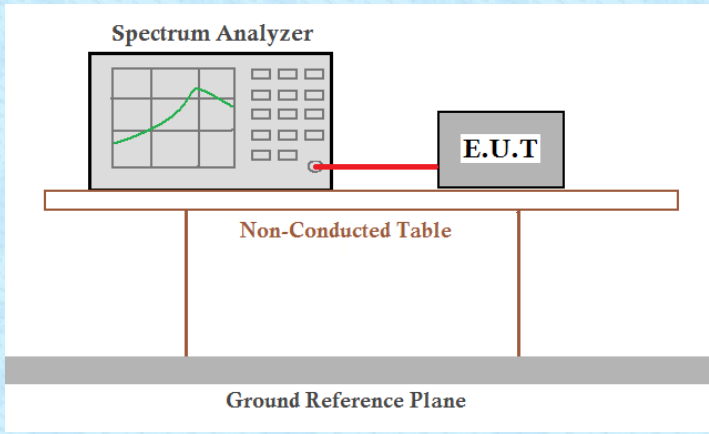
Test Requirement:	FCC Part15 C Section 15.247(a)(1)
Test Method:	ANSI C63.10:2013
Limit:	20.97dBm
Test setup:	 <p>The diagram illustrates the test setup. A Spectrum Analyzer is connected to an E.U.T. (Equipment Under Test) via a red cable. Both are placed on a Non-Conducted Table, which sits on a Ground Reference Plane.</p>
Test Instruments:	Refer to section 6.0 for details
Test mode:	Refer to section 5.2 for details
Test results:	Pass

Measurement Data: The detailed test data see Appendix for 2.4G.

7.4 20dB Emission Bandwidth

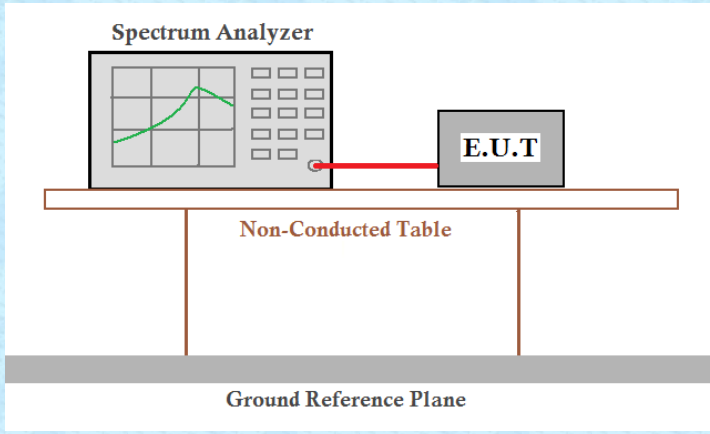
Test Requirement:	FCC Part15 C Section 15.247 (a)(1)
Test Method:	ANSI C63.10:2013
Limit:	N/A
Test setup:	 <p>The diagram illustrates the test setup. A Spectrum Analyzer is connected to an E.U.T. (Equipment Under Test) via a red cable. Both are placed on a Non-Conducted Table, which is supported by a Ground Reference Plane.</p>
Test Instruments:	Refer to section 6.0 for details
Test mode:	Refer to section 5.2 for details
Test results:	Pass

Measurement Data: The detailed test data see Appendix for 2.4G.

7.5 Carrier Frequencies Separation

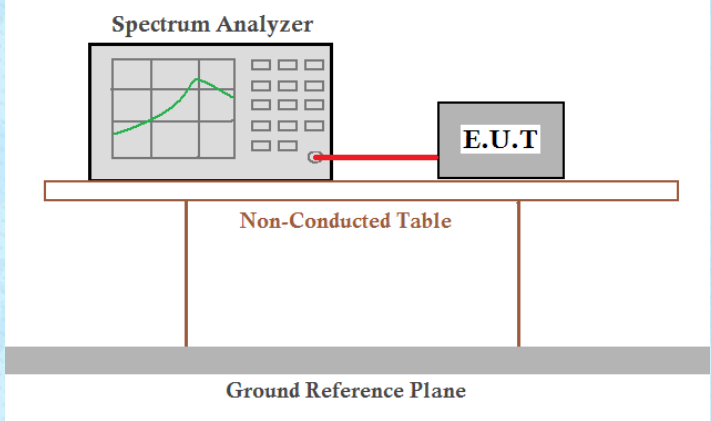
Test Requirement:	FCC Part15 C Section 15.247 (a)(1)
Test Method:	ANSI C63.10:2013
Receiver setup:	RBW=100KHz, VBW=300KHz, detector=Peak
Limit:	0.025MHz or 2/3 of the 20dB bandwidth (whichever is greater)
Test setup:	 <p>The diagram illustrates the test setup. A Spectrum Analyzer is connected to an E.U.T. (Equipment Under Test) via a red cable. Both are placed on a Non-Conducted Table, which is supported by a Ground Reference Plane.</p>
Test Instruments:	Refer to section 6.0 for details
Test mode:	Refer to section 5.2 for details
Test results:	Pass

Measurement Data: The detailed test data see Appendix for 2.4G.

7.6 Hopping Channel Number

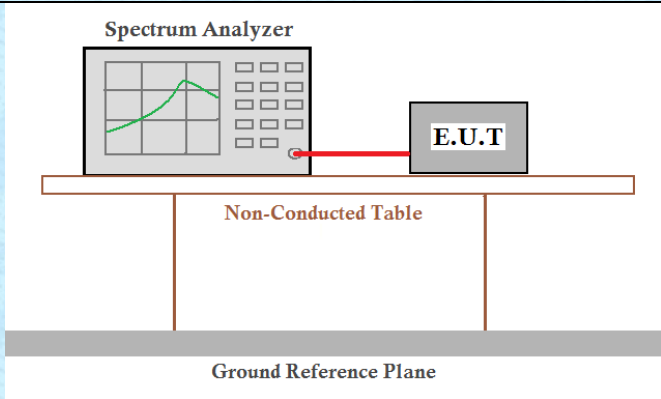
Test Requirement:	FCC Part15 C Section 15.247 (a)(1)(iii)
Test Method:	ANSI C63.10:2013
Receiver setup:	RBW=100kHz, VBW=300kHz, Frequency range=2400MHz-2483.5MHz, Detector=Peak
Limit:	15 channels
Test setup:	 <p>The diagram illustrates the test setup. A Spectrum Analyzer is connected to an E.U.T. (Equipment Under Test) via a red cable. Both are placed on a Non-Conducted Table, which sits on a Ground Reference Plane.</p>
Test Instruments:	Refer to section 6.0 for details
Test mode:	Refer to section 5.2 for details
Test results:	Pass

Measurement Data: The detailed test data see Appendix for 2.4G.

7.7 Dwell Time

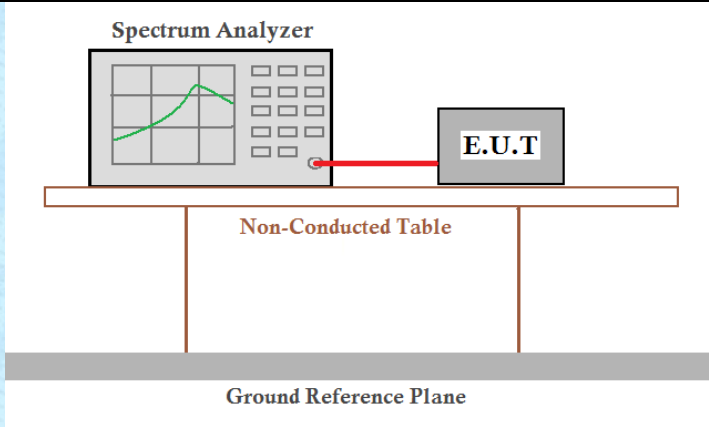
Test Requirement:	FCC Part15 C Section 15.247 (a)(1)(iii)
Test Method:	ANSI C63.10:2013
Receiver setup:	RBW=1MHz, VBW=1MHz, Span=0Hz, Detector=Peak
Limit:	0.4 Second
Test setup:	 <p>The diagram illustrates the test setup. A Spectrum Analyzer is connected to an E.U.T. (Equipment Under Test) via a red cable. Both are placed on a Non-Conducted Table, which is supported by a Ground Reference Plane.</p>
Test Instruments:	Refer to section 6.0 for details
Test mode:	Refer to section 5.2 for details
Test results:	Pass

Measurement Data: The detailed test data see Appendix for 2.4G.

7.8 Spurious Emission in Non-restricted & restricted Bands

7.8.1 Conducted Emission Method

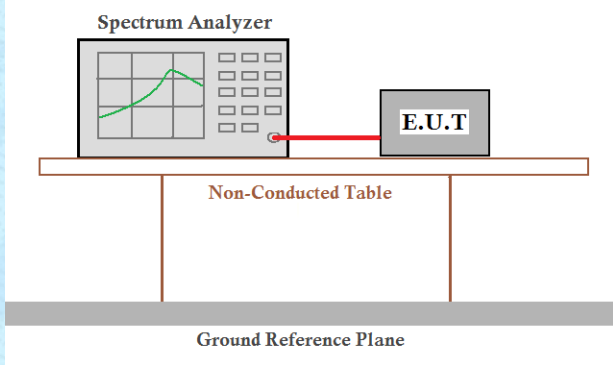
Test Requirement:	FCC Part15 C Section 15.247 (d)
Test Method:	ANSI C63.10:2013
Receiver setup:	RBW=100kHz, VBW=300kHz, Detector=Peak
Limit:	In any 100 kHz bandwidth outside the frequency band in which the spread spectrum intentional radiator is operating, the radio frequency power that is produced by the intentional radiator shall be at least 20 dB below that in the 100 kHz bandwidth within the band that contains the highest level of the desired power, based on either an RF conducted or a radiated measurement.
Test setup:	 <p>The diagram illustrates the test setup. A Spectrum Analyzer is connected to an E.U.T. (Equipment Under Test) via a red cable. Both are placed on a Non-Conducted Table, which sits on a Ground Reference Plane.</p>
Test Instruments:	Refer to section6.0 for details
Test mode:	Refer to section 5.2 for details
Test results:	Pass

Measurement Data: The detailed test data see Appendix for 2.4G.

7.8.2 Radiated Emission Method

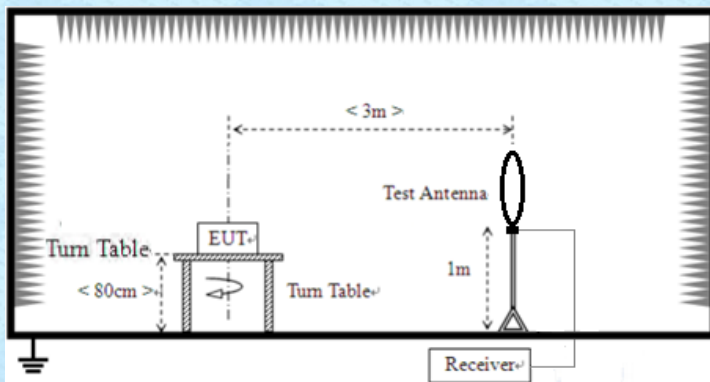
Test Requirement:	FCC Part15 C Section 15.209 and 15.205				
Test Method:	ANSI C63.10:2013				
Test Frequency Range:	9kHz to 25GHz				
Test site:	Measurement Distance: 3m				
Receiver setup:	Frequency	Detector	RBW	VBW	Value
	9KHz-150KHz	Quasi-peak	200Hz	600Hz	Quasi-peak
	150KHz-30MHz	Quasi-peak	9KHz	30KHz	Quasi-peak
	30MHz-1GHz	Quasi-peak	120KHz	300KHz	Quasi-peak
	Above 1GHz	Peak	1MHz	3MHz	Peak
Peak		1MHz	10Hz	Average	
Limit: (Spurious Emissions)	Frequency	Limit (uV/m)	Value	Measurement Distance	
	0.009MHz-0.490MHz	2400/F(KHz)	QP	300m	
	0.490MHz-1.705MHz	24000/F(KHz)	QP	300m	
	1.705MHz-30MHz	30	QP	30m	
	30MHz-88MHz	100	QP	3m	
	88MHz-216MHz	150	QP		
	216MHz-960MHz	200	QP		
	960MHz-1GHz	500	QP		
	Above 1GHz	500	Average		
5000		Peak			
Test setup:	Below 30MHz				
	 <p>Below 1GHz</p>				

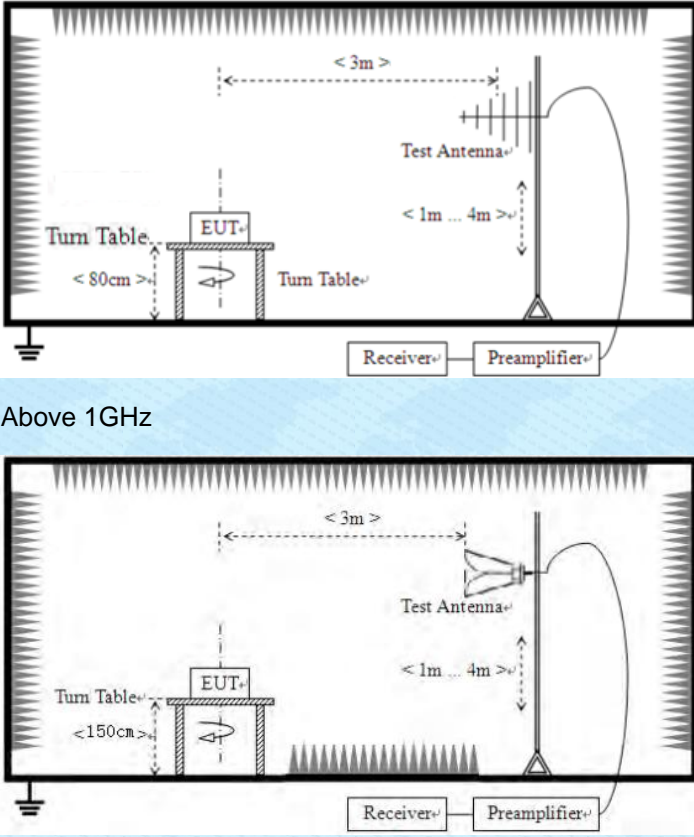
	 <p>Above 1GHz</p>						
<p>Test Procedure:</p>	<ol style="list-style-type: none"> 1. The EUT was placed on the top of a rotating table (0.8 meters for below 1GHz and 1.5meters for above 1GHz) above the ground at a 3 meter camber. The table was rotated 360 degrees to determine the position of the highest radiation. 2. The EUT was set 3 meters away from the interference-receiving antenna, which was mounted on the top of a variable-height antenna tower. 3. The antenna height is varied from one meter to four meters above the ground to determine the maximum value of the field strength. Both horizontal and vertical polarizations of the antenna are set to make the measurement. 4. For each suspected emission, the EUT was arranged to its worst case and then the antenna was tuned to heights from 1 meter to 4 meters and the rota table was turned from 0 degrees to 360 degrees to find the maximum reading. 5. The test-receiver system was set to Peak Detect Function and Specified Bandwidth with Maximum Hold Mode. 6. If the emission level of the EUT in peak mode was 10dB lower than the limit specified, then testing could be stopped and the peak values of the EUT would be reported. Otherwise the emissions that did not have 10dB margin would be re-tested one by one using peak, quasi-peak or average method as specified and then reported in a data sheet. 						
<p>Test Instruments:</p>	<p>Refer to section 5.8 for details</p>						
<p>Test mode:</p>	<p>Refer to section 5.2 for details</p>						
<p>Temp. / Hum.</p>	<table border="1"> <tr> <td>Temp.:</td> <td>25 °C</td> <td>Humid.:</td> <td>52%</td> <td>Press.:</td> <td>1 012mbar</td> </tr> </table>	Temp.:	25 °C	Humid.:	52%	Press.:	1 012mbar
Temp.:	25 °C	Humid.:	52%	Press.:	1 012mbar		

Test results:	Pass
---------------	------

Remark:

1. *Pre-scan all kind of the place mode (X-axis, Y-axis, Z-axis), and found the Y-axis which it is worse case.*

Measurement data:

■ **Below 30MHz**

The low frequency, which started from 9 kHz to 30 MHz, was pre-scanned and the result which was 20 dB lower than the limit line per 15.31(o) was not reported.

All antennas have test, only the worst case ANT 1 report.

■ 30MHz ~ 1GHz

Test channel:	Lowest	Polarization:	Horizontal
---------------	--------	---------------	------------

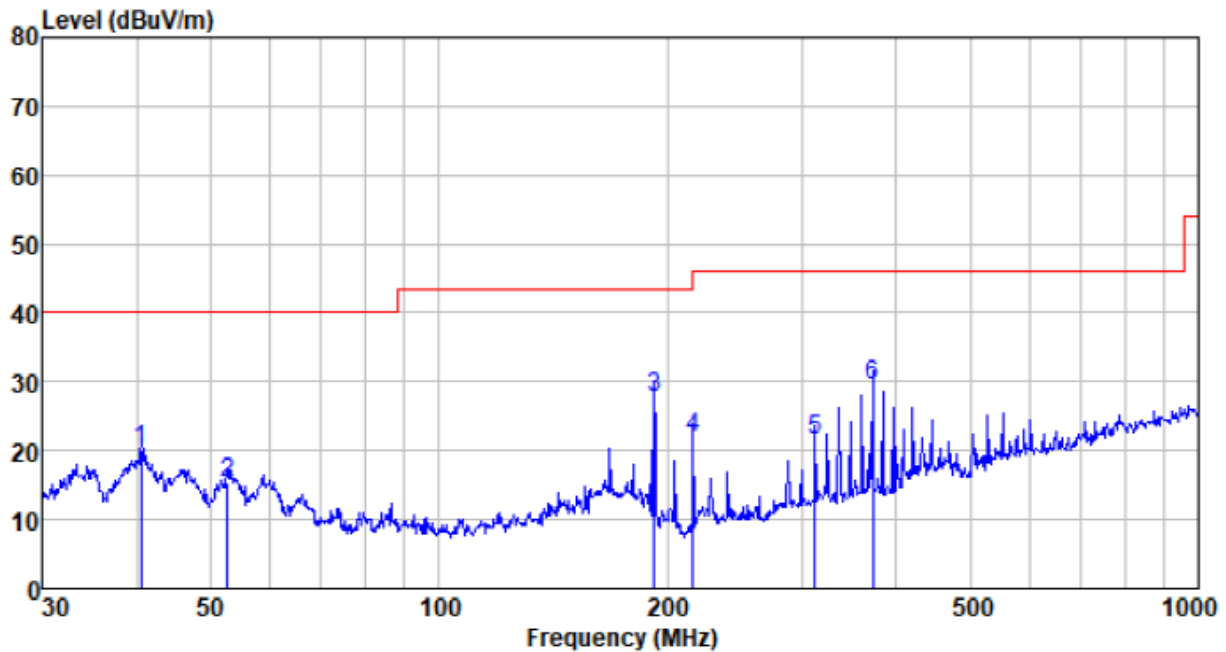

Freq MHz	Reading level dBuV	Antenna factor dB/m	Cable loss dB	Preamp factor dB	level dBuV/m	Limit level dBuV/m	Over limit dB	Remark
40.559	41.74	13.23	0.67	35.70	19.94	40.00	-20.06	QP
52.575	37.88	12.79	0.79	36.22	15.24	40.00	-24.76	QP
191.745	53.50	9.73	1.80	37.29	27.74	43.50	-15.76	QP
216.024	48.33	9.01	1.93	37.35	21.92	46.00	-24.08	QP
312.179	43.73	12.75	2.42	37.43	21.47	46.00	-24.53	QP
372.005	50.16	14.11	2.72	37.49	29.50	46.00	-16.50	QP

Test channel:	Lowest	Polarization:	Vertical
---------------	--------	---------------	----------

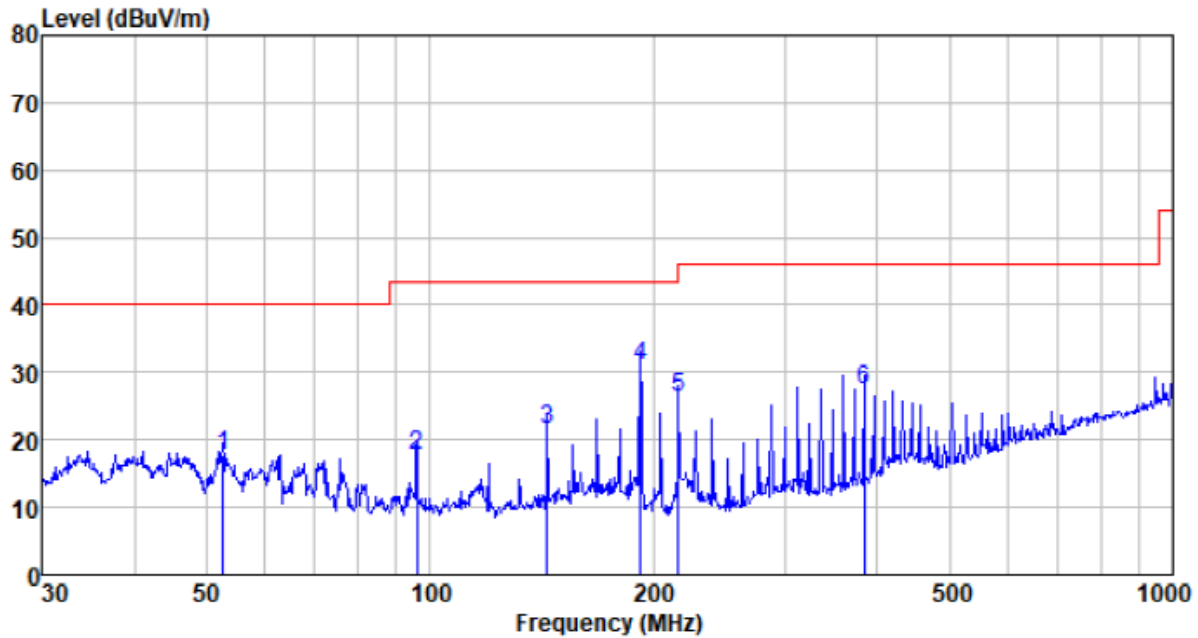

Freq MHz	Reading level dBuV	Antenna factor dB/m	Cable loss dB	Preamp factor dB	level dBuV/m	Limit level dBuV/m	Over limit dB	Remark
52.575	40.22	12.79	0.79	36.22	17.58	40.00	-22.42	QP
96.099	44.41	8.85	1.16	36.69	17.73	43.50	-25.77	QP
143.830	44.83	12.32	1.53	37.04	21.64	43.50	-21.86	QP
191.745	56.72	9.73	1.80	37.29	30.96	43.50	-12.54	QP
216.024	52.59	9.01	1.93	37.35	26.18	46.00	-19.82	QP
383.932	47.86	14.37	2.78	37.51	27.50	46.00	-18.50	QP

Test channel:	Middle	Polarization:	Horizontal
---------------	--------	---------------	------------

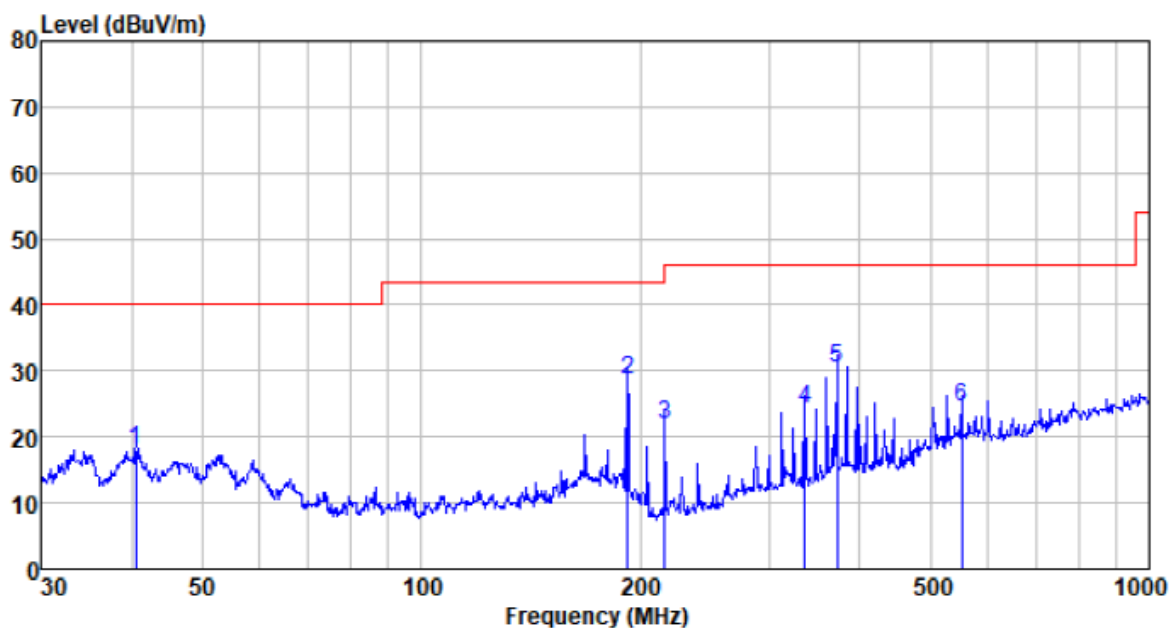

Freq MHz	Reading level dBuV	Antenna factor dB/m	Cable loss dB	Preamp factor dB	level dBuV/m	Limit level dBuV/m	Over limit dB	Remark
40.559	39.74	13.23	0.67	35.70	17.94	40.00	-22.06	QP
191.745	54.50	9.73	1.80	37.29	28.74	43.50	-14.76	QP
216.024	48.33	9.01	1.93	37.35	21.92	46.00	-24.08	QP
336.035	45.80	13.30	2.55	37.46	24.19	46.00	-21.81	QP
372.005	51.16	14.11	2.72	37.49	30.50	46.00	-15.50	QP
552.883	40.41	18.00	3.53	37.53	24.41	46.00	-21.59	QP

Test channel:	Middle	Polarization:	Vertical
---------------	--------	---------------	----------

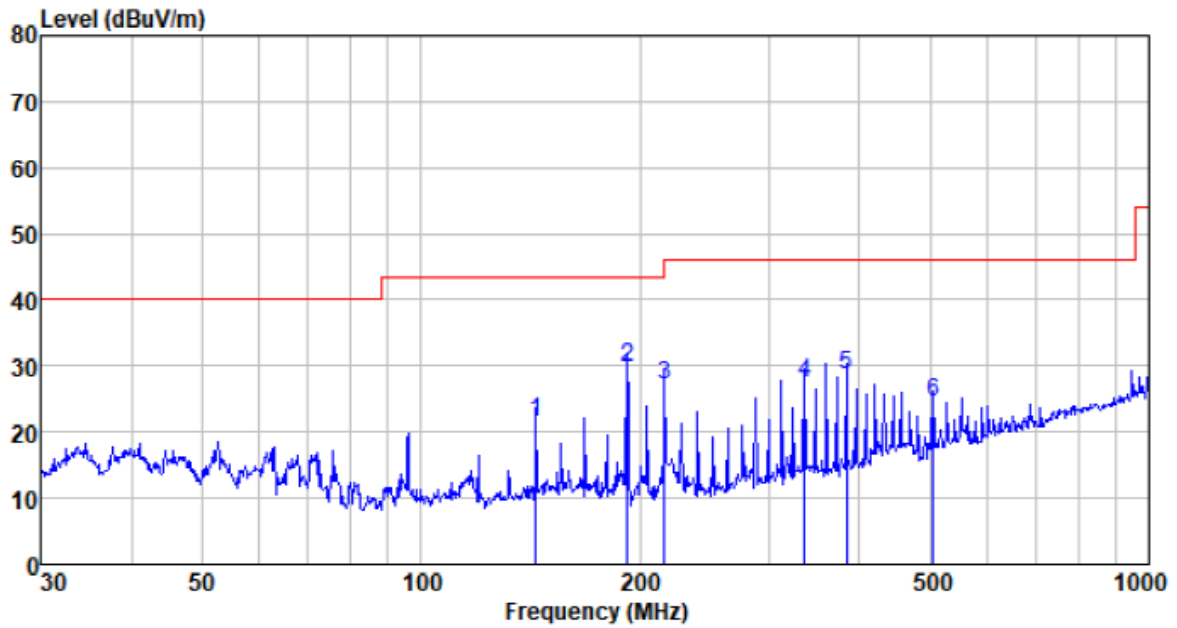

Freq MHz	Reading level dBuV	Antenna factor dB/m	Cable loss dB	Preamp factor dB	level dBuV/m	Limit level dBuV/m	Over limit dB	Remark
143.830	44.83	12.32	1.53	37.04	21.64	43.50	-21.86	QP
191.745	55.72	9.73	1.80	37.29	29.96	43.50	-13.54	QP
216.024	53.59	9.01	1.93	37.35	27.18	46.00	-18.82	QP
336.035	49.07	13.30	2.55	37.46	27.46	46.00	-18.54	QP
383.932	48.86	14.37	2.78	37.51	28.50	46.00	-17.50	QP
504.706	41.84	16.73	3.33	37.51	24.39	46.00	-21.61	QP

Test channel:	Highest	Polarization:	Horizontal
---------------	---------	---------------	------------

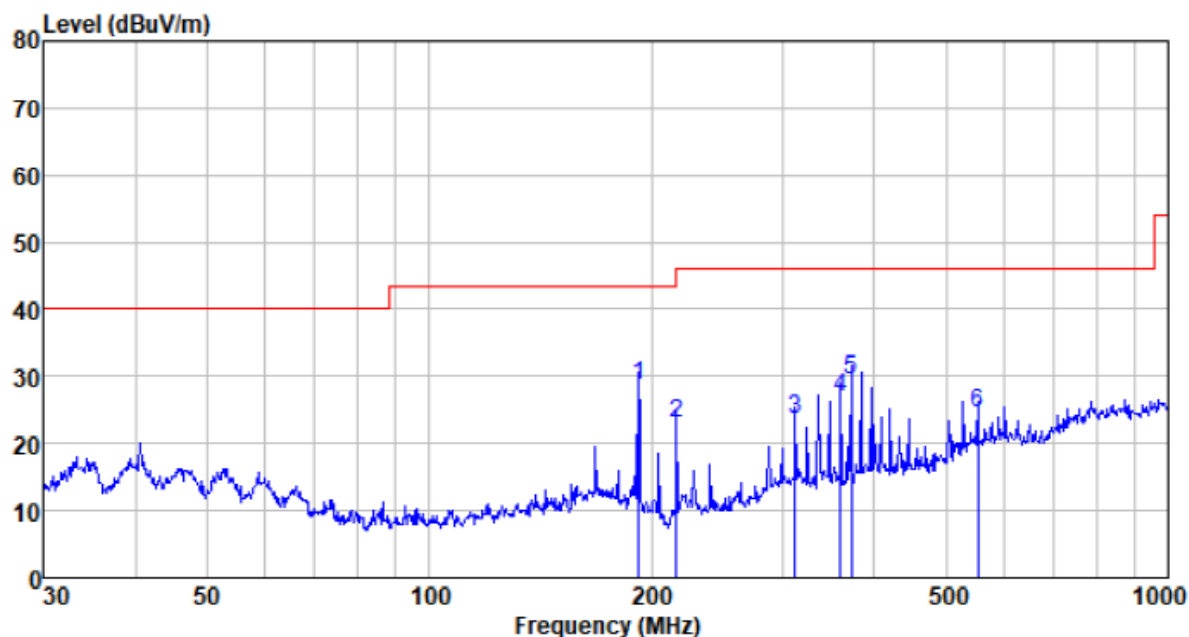

Freq MHz	Reading level dBuV	Antenna factor dB/m	Cable loss dB	Preamp factor dB	level dBuV/m	Limit level dBuV/m	Over limit dB	Remark
191.745	54.50	9.73	1.80	37.29	28.74	43.50	-14.76	QP
216.024	49.33	9.01	1.93	37.35	22.92	46.00	-23.08	QP
312.179	45.73	12.75	2.42	37.43	23.47	46.00	-22.53	QP
360.448	47.94	13.82	2.67	37.48	26.95	46.00	-19.05	QP
372.005	50.16	14.11	2.72	37.49	29.50	46.00	-16.50	QP
552.883	40.41	18.00	3.53	37.53	24.41	46.00	-21.59	QP

Test channel:	Highest	Polarization:	Vertical
---------------	---------	---------------	----------

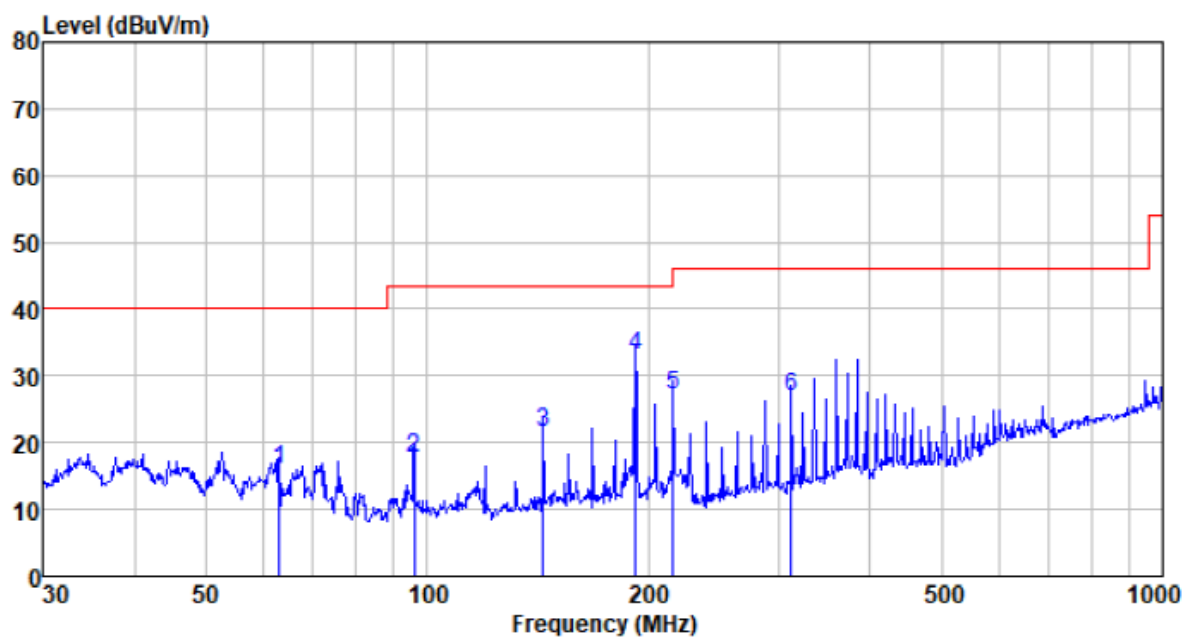

Freq MHz	Reading level dBuV	Antenna factor dB/m	Cable loss dB	Preamp factor dB	level dBuV/m	Limit level dBuV/m	Over limit dB	Remark
62.871	39.48	11.82	0.88	36.36	15.82	40.00	-24.18	QP
96.099	44.41	8.85	1.16	36.69	17.73	43.50	-25.77	QP
143.830	44.83	12.32	1.53	37.04	21.64	43.50	-21.86	QP
191.745	58.72	9.73	1.80	37.29	32.96	43.50	-10.54	QP
216.024	53.59	9.01	1.93	37.35	27.18	46.00	-18.82	QP
312.179	49.04	12.75	2.42	37.43	26.78	46.00	-19.22	QP

- Unwanted Emissions in Restricted Frequency Bands
- Above 1GHz

Test channel:	Lowest	Polarization:	Horizontal
---------------	--------	---------------	------------

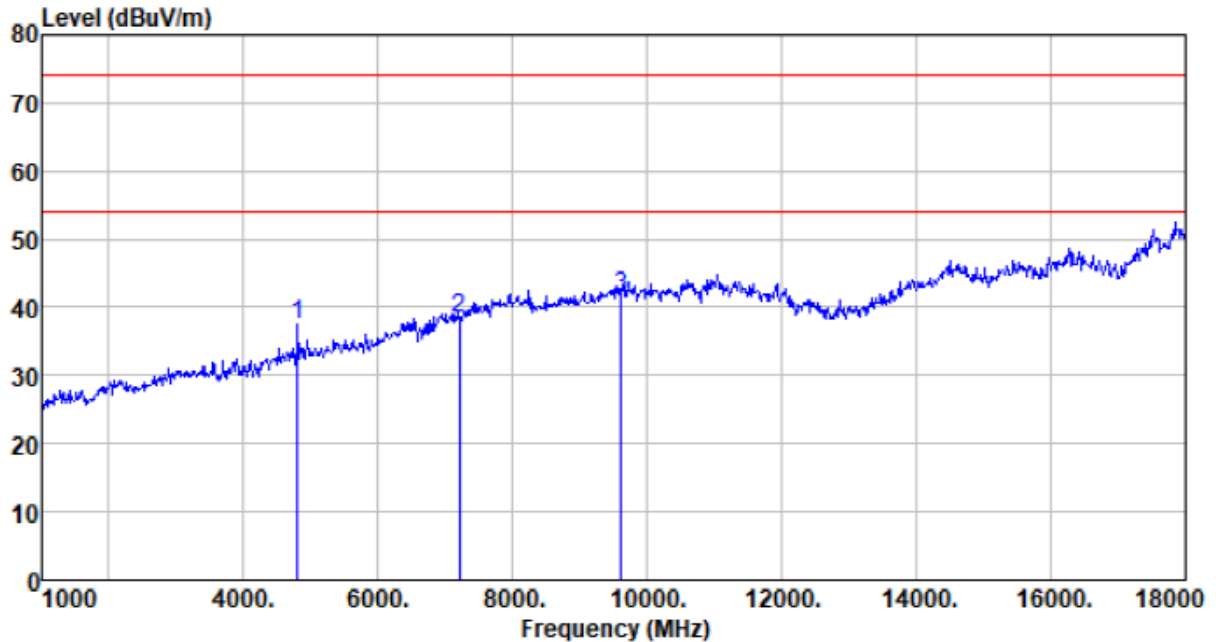

Freq MHz	Reading level dBuV	Antenna factor dB/m	Cable loss dB	Preamp factor dB	level dBuV/m	Limit level dBuV/m	Over limit dB	Remark
4805.000	39.24	31.20	4.61	37.69	37.36	74.00	-36.64	Peak
7207.500	33.67	36.16	6.48	37.82	38.49	74.00	-35.51	Peak
9610.000	33.74	37.93	7.97	37.92	41.72	74.00	-32.28	Peak

Test channel:	Lowest	Polarization:	Vertical
---------------	--------	---------------	----------

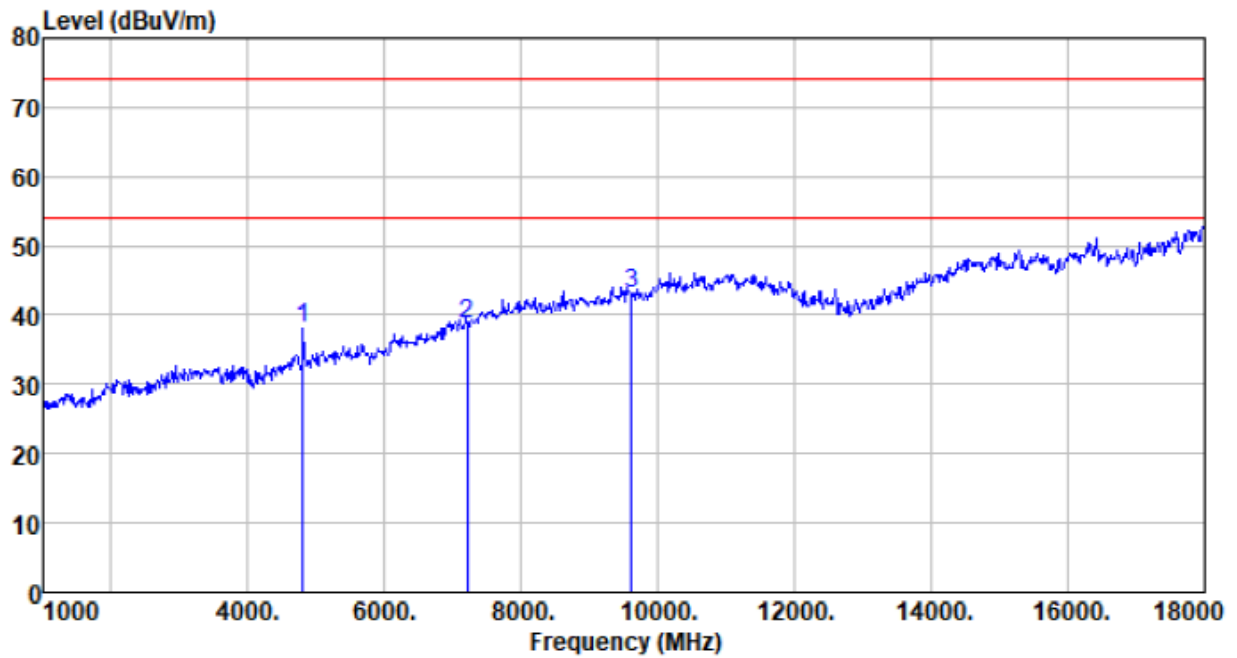

Freq MHz	Reading level dBuV	Antenna factor dB/m	Cable loss dB	Preamp factor dB	level dBuV/m	Limit level dBuV/m	Over limit dB	Remark
4805.000	40.07	31.20	4.61	37.69	38.19	74.00	-35.81	Peak
7207.500	33.71	36.16	6.48	37.82	38.53	74.00	-35.47	Peak
9610.000	35.06	37.93	7.97	37.92	43.04	74.00	-30.96	Peak

Test channel:	Middle	Polarization:	Horizontal
---------------	--------	---------------	------------

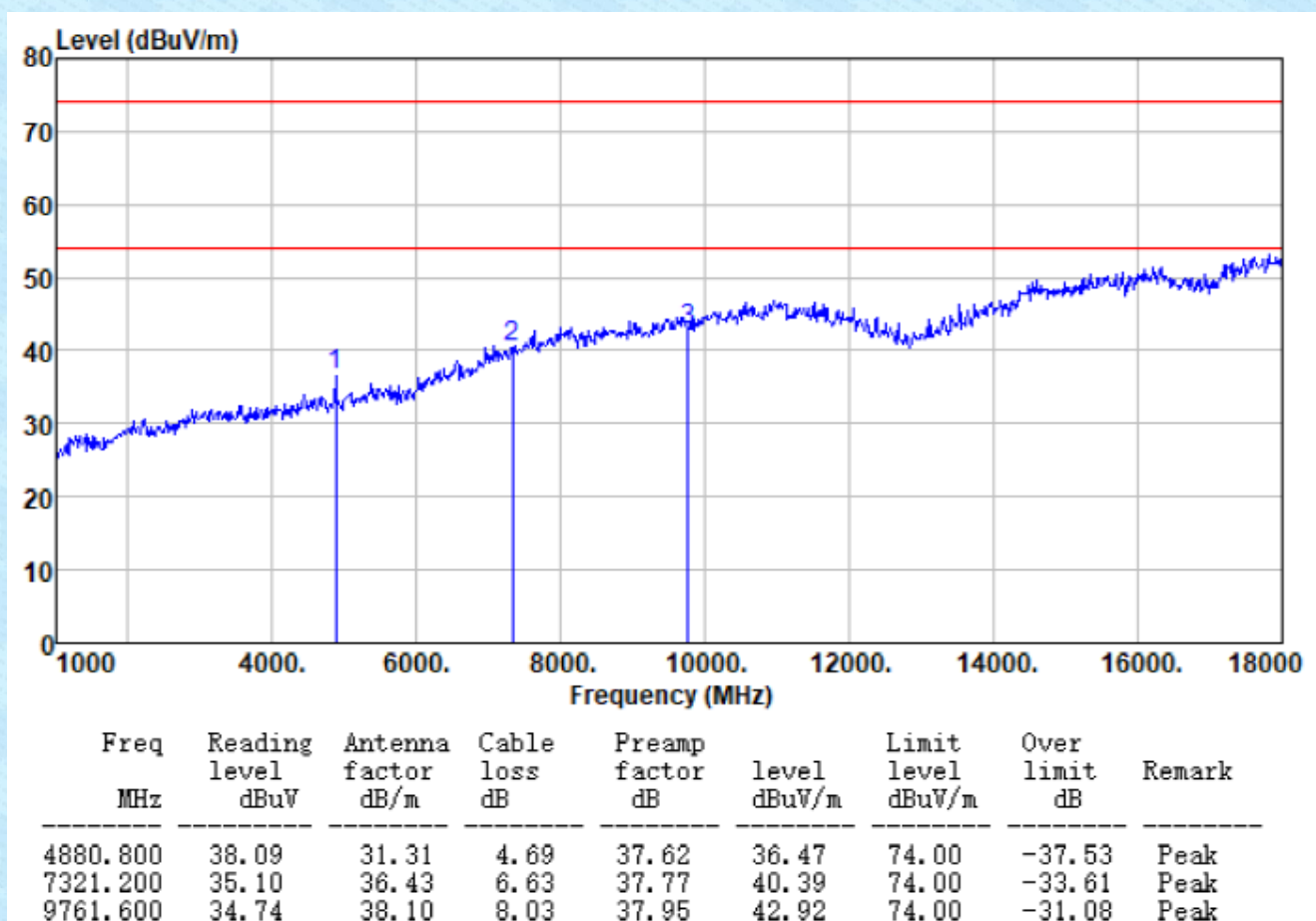

Test channel:	Middle	Polarization:	Vertical
---------------	--------	---------------	----------

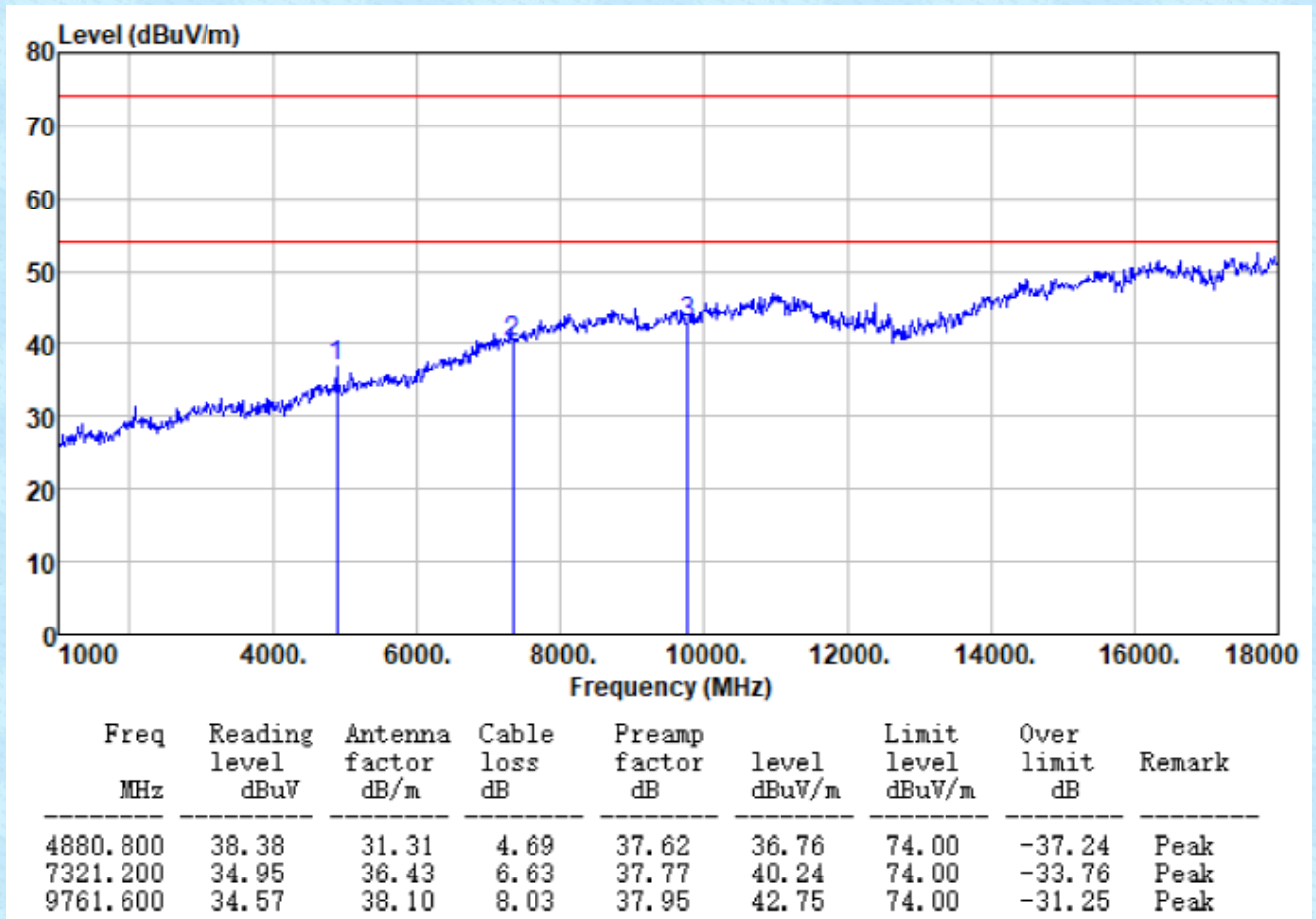

Test channel:	Highest	Polarization:	Horizontal
---------------	---------	---------------	------------

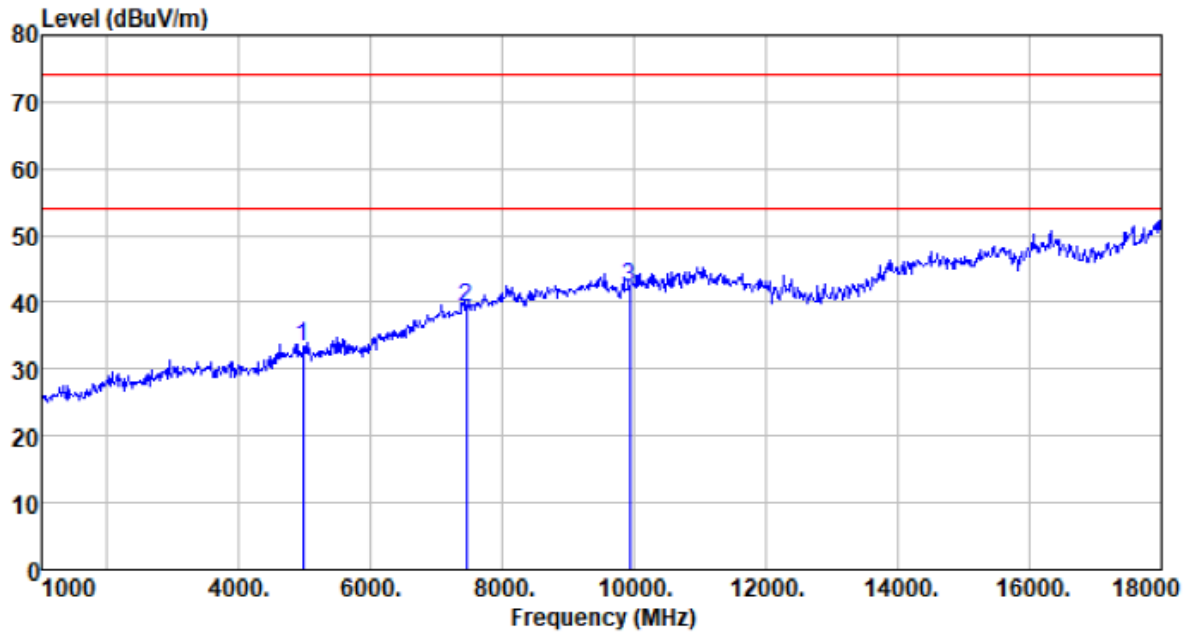

Freq MHz	Reading level dBuV	Antenna factor dB/m	Cable loss dB	Preamp factor dB	level dBuV/m	Limit level dBuV/m	Over limit dB	Remark
4960.000	34.59	31.44	4.79	37.54	33.28	74.00	-40.72	Peak
7440.000	33.52	36.66	6.77	37.72	39.23	74.00	-34.77	Peak
9920.000	33.89	38.30	8.09	37.98	42.30	74.00	-31.70	Peak

Test channel:	Highest	Polarization:	Vertical
---------------	---------	---------------	----------

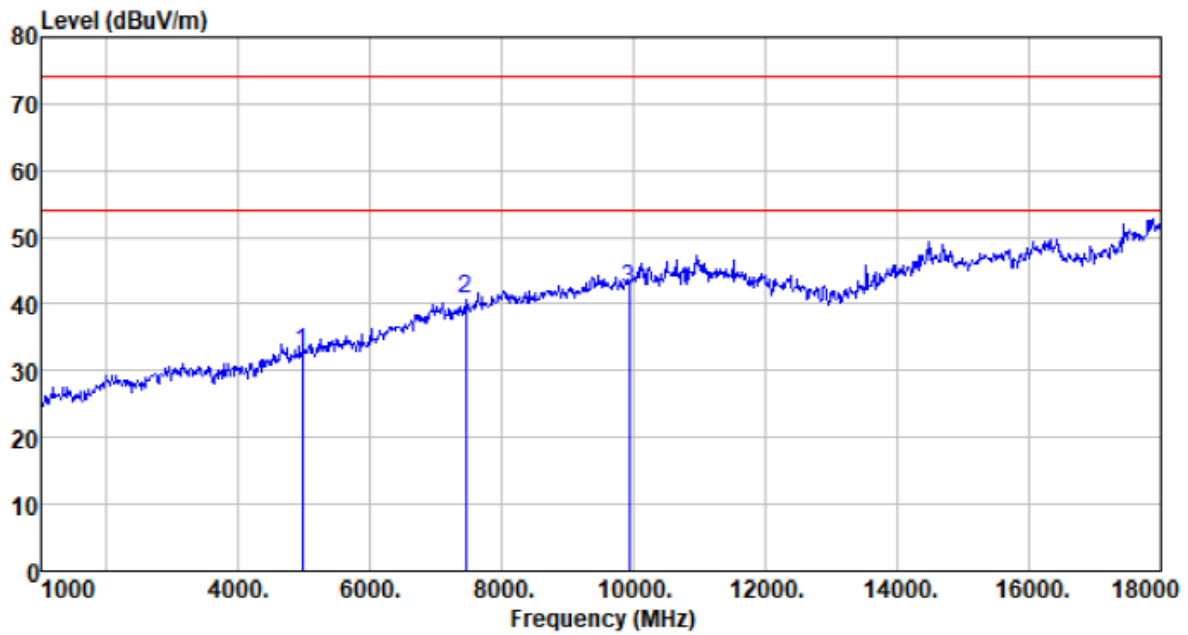

Freq MHz	Reading level dBuV	Antenna factor dB/m	Cable loss dB	Preamp factor dB	level dBuV/m	Limit level dBuV/m	Over limit dB	Remark
4960.000	34.16	31.44	4.79	37.54	32.85	74.00	-41.15	Peak
7440.000	34.89	36.66	6.77	37.72	40.60	74.00	-33.40	Peak
9920.000	33.86	38.30	8.09	37.98	42.27	74.00	-31.73	Peak

Remark:

1. *Final Level = Receiver Read level + Antenna Factor + Cable Loss – Preamplifier Factor*
2. *“*”, means this data is the too weak instrument of signal is unable to test.*
3. *The emission levels of other frequencies are very lower than the limit and not show in test report.*
4. *For above 18GHz, no emission found.*

Unwanted Emissions in Non-restricted Frequency Bands

ANT 1:

Test channel:	Lowest	Polarization:	Horizontal
---------------	--------	---------------	------------

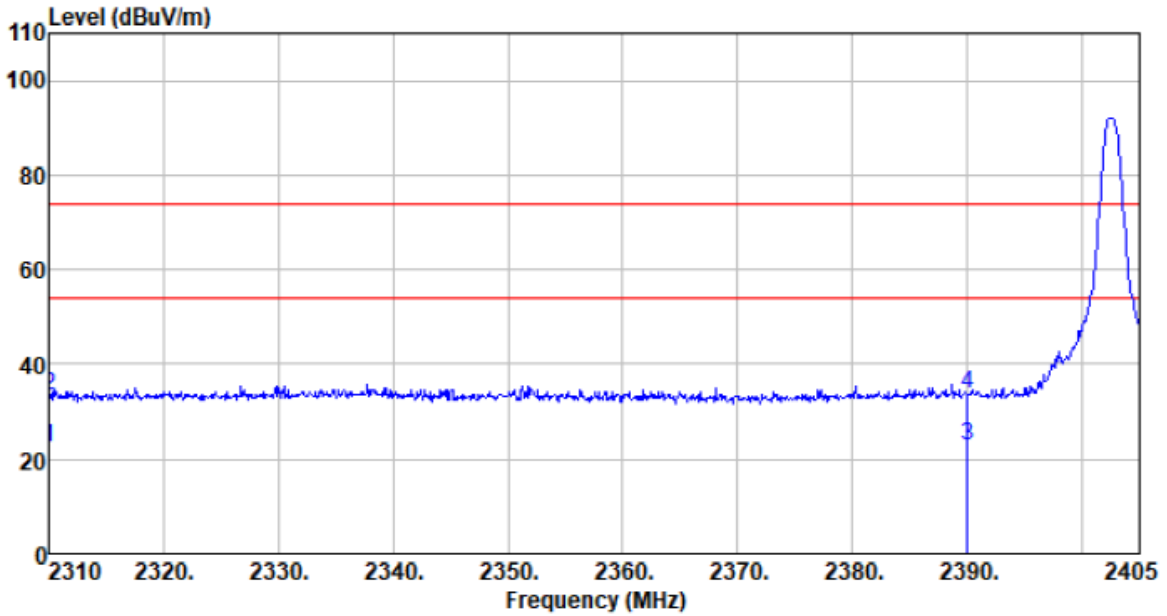

Freq MHz	Reading level dBuV	Antenna factor dB/m	Cable loss dB	Preamp factor dB	level dBuV/m	Limit level dBuV/m	Over limit dB	Remark
2310.000	30.97	27.14	2.81	38.64	22.28	54.00	-31.72	Average
2310.000	41.92	27.14	2.81	38.64	33.23	74.00	-40.77	Peak
2390.000	31.25	27.37	2.91	38.84	22.69	54.00	-31.31	Average
2390.000	42.12	27.37	2.91	38.84	33.56	74.00	-40.44	Peak

Test channel:	Lowest	Polarization:	Vertical
---------------	--------	---------------	----------

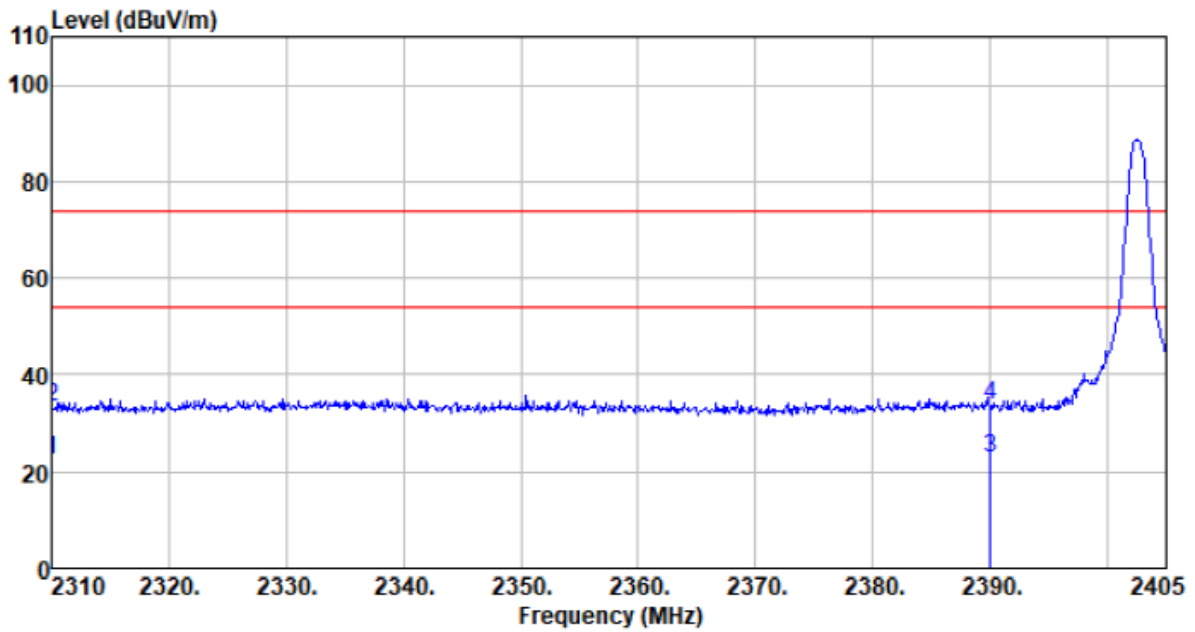

Freq MHz	Reading level dBuV	Antenna factor dB/m	Cable loss dB	Preamp factor dB	level dBuV/m	Limit level dBuV/m	Over limit dB	Remark
2310.000	31.02	27.14	2.81	38.64	22.33	54.00	-31.67	Average
2310.000	42.07	27.14	2.81	38.64	33.38	74.00	-40.62	Peak
2390.000	31.18	27.37	2.91	38.84	22.62	54.00	-31.38	Average
2390.000	42.09	27.37	2.91	38.84	33.53	74.00	-40.47	Peak

Test channel:	Highest	Polarization:	Horizontal
---------------	---------	---------------	------------

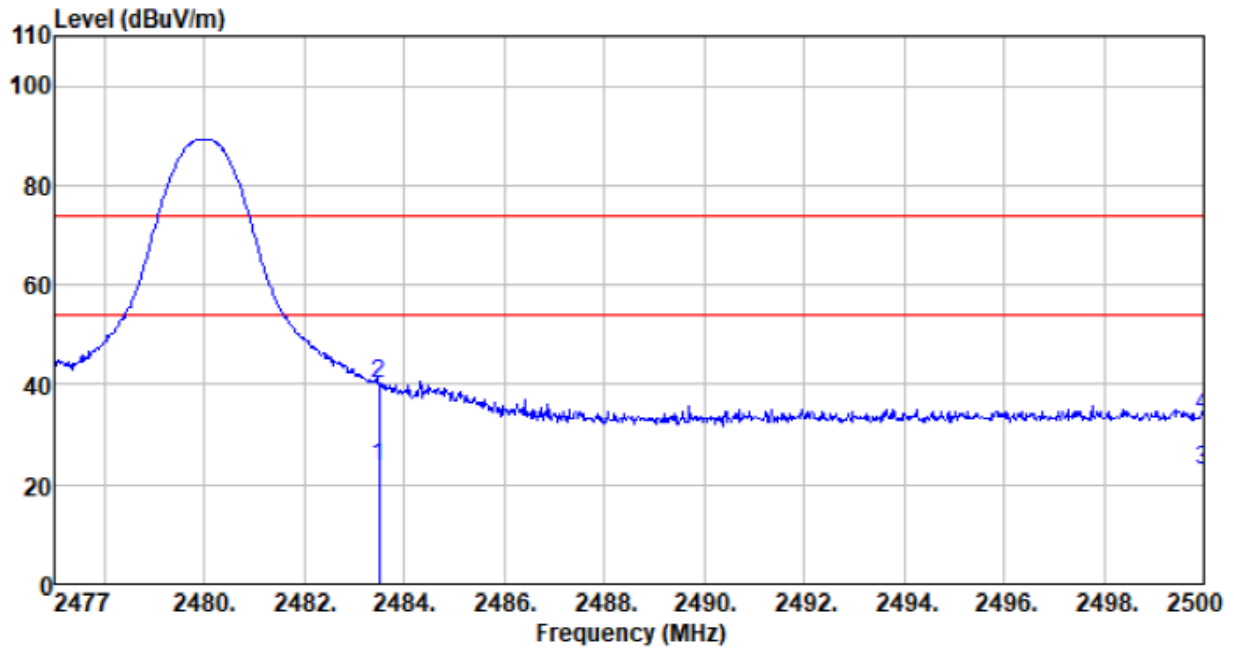

Freq MHz	Reading level dBuV	Antenna factor dB/m	Cable loss dB	Preamp factor dB	level dBuV/m	Limit level dBuV/m	Over limit dB	Remark
2483.500	32.06	27.66	2.99	39.06	23.65	54.00	-30.35	Average
2483.500	48.50	27.66	2.99	39.06	40.09	74.00	-33.91	Peak
2500.000	31.01	27.70	3.01	39.10	22.62	54.00	-31.38	Average
2500.000	41.95	27.70	3.01	39.10	33.56	74.00	-40.44	Peak

Test channel:	Highest	Polarization:	Vertical
---------------	---------	---------------	----------

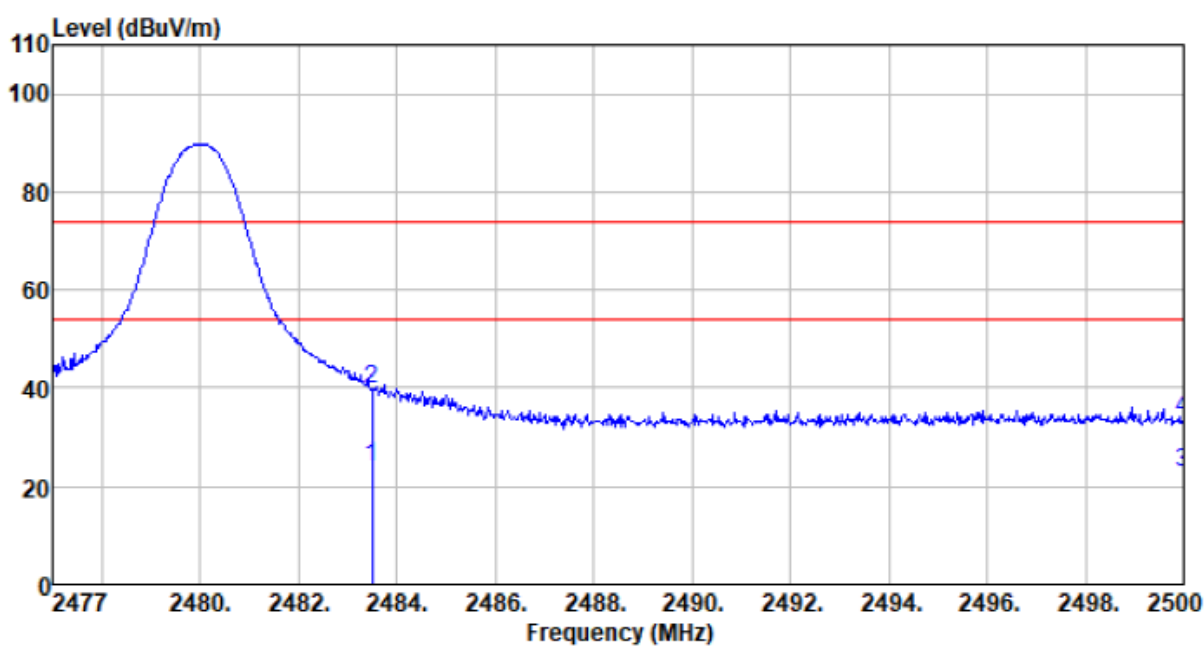

Freq MHz	Reading level dBuV	Antenna factor dB/m	Cable loss dB	Preamp factor dB	level dBuV/m	Limit level dBuV/m	Over limit dB	Remark
2483.500	32.49	27.66	2.99	39.06	24.08	54.00	-29.92	Average
2483.500	48.20	27.66	2.99	39.06	39.79	74.00	-34.21	Peak
2500.000	31.09	27.70	3.01	39.10	22.70	54.00	-31.30	Average
2500.000	42.20	27.70	3.01	39.10	33.81	74.00	-40.19	Peak

ANT 2:

Test channel:	Lowest	Polarization:	Horizontal
---------------	--------	---------------	------------

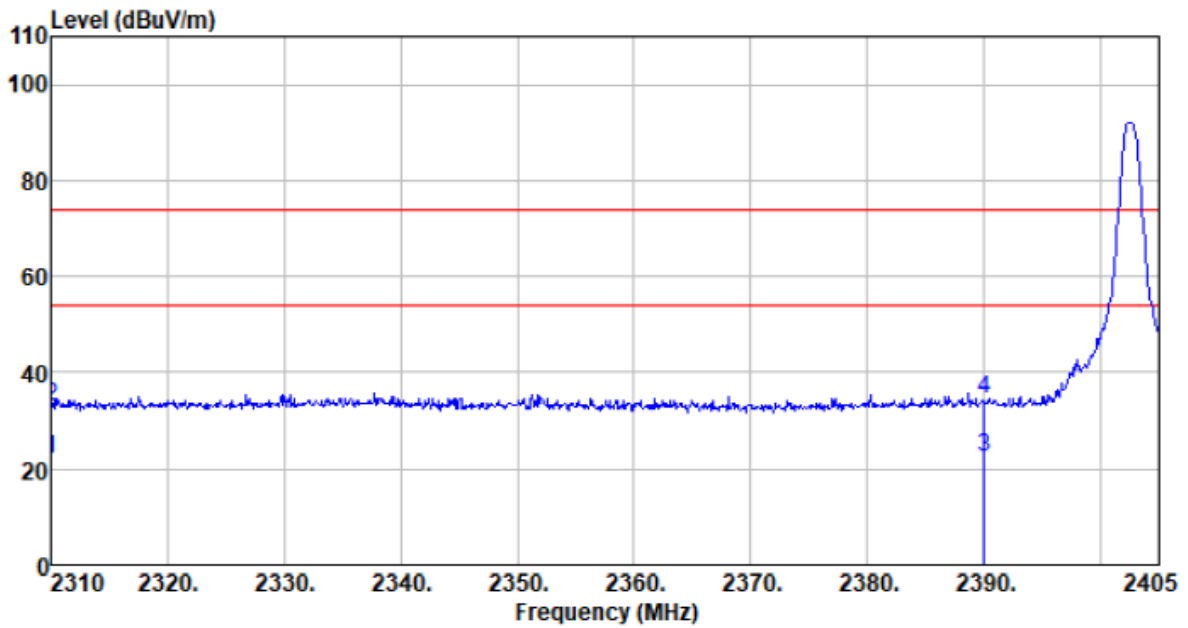

Freq MHz	Reading level dBuV	Antenna factor dB/m	Cable loss dB	Preamp factor dB	level dBuV/m	Limit level dBuV/m	Over limit dB	Remark
2310.000	30.57	27.14	2.81	38.64	21.88	54.00	-32.12	Average
2310.000	41.56	27.14	2.81	38.64	32.87	74.00	-41.13	Peak
2390.000	31.03	27.37	2.91	38.84	22.47	54.00	-31.53	Average
2390.000	42.86	27.37	2.91	38.84	34.30	74.00	-39.70	Peak

Test channel:	Lowest	Polarization:	Vertical
---------------	--------	---------------	----------

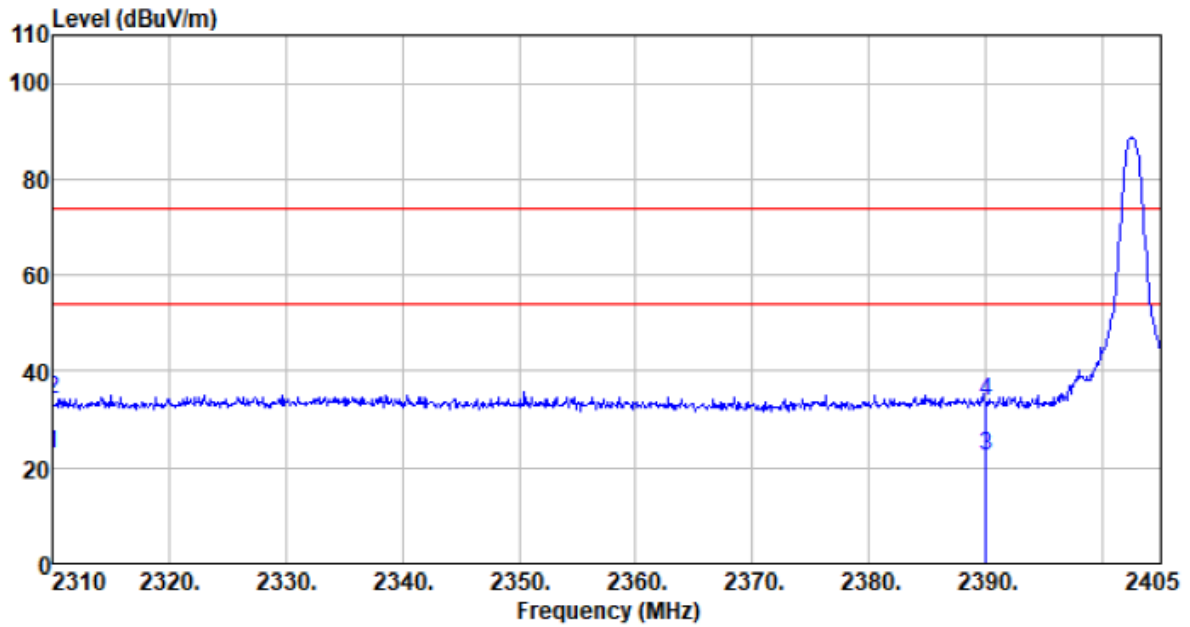

Freq MHz	Reading level dBuV	Antenna factor dB/m	Cable loss dB	Preamp factor dB	level dBuV/m	Limit level dBuV/m	Over limit dB	Remark
2310.000	31.42	27.14	2.81	38.64	22.73	54.00	-31.27	Average
2310.000	42.58	27.14	2.81	38.64	33.89	74.00	-40.11	Peak
2390.000	31.03	27.37	2.91	38.84	22.47	54.00	-31.53	Average
2390.000	42.34	27.37	2.91	38.84	33.78	74.00	-40.22	Peak

Test channel:	Highest	Polarization:	Horizontal
---------------	---------	---------------	------------

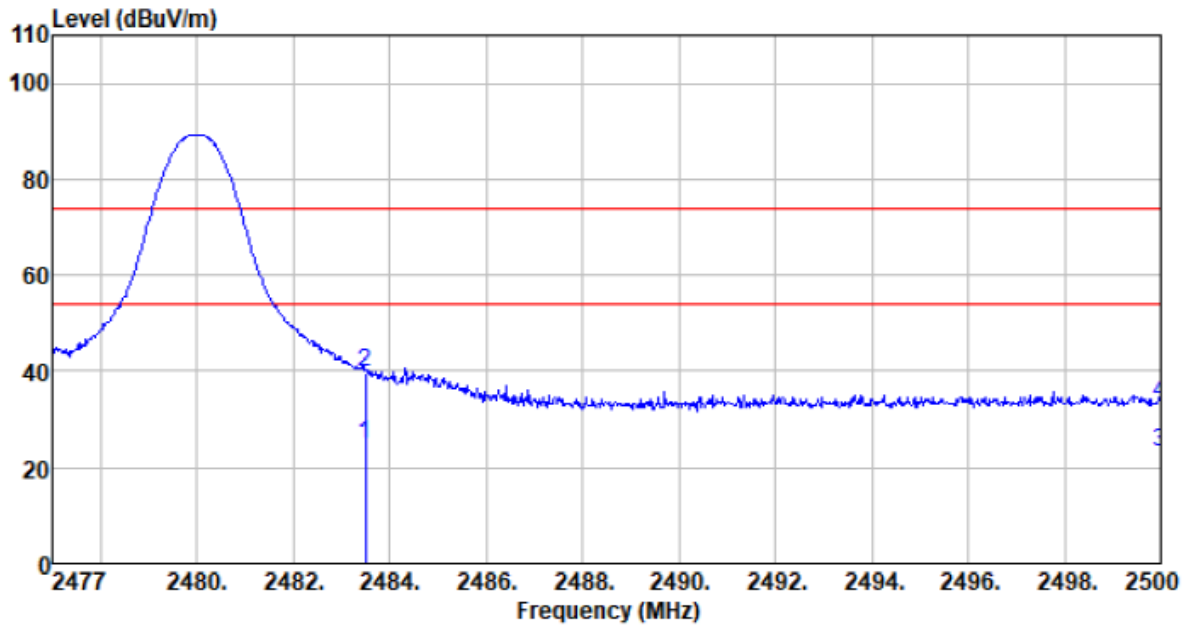

Freq MHz	Reading level dBuV	Antenna factor dB/m	Cable loss dB	Preamp factor dB	level dBuV/m	Limit level dBuV/m	Over limit dB	Remark
2483.500	32.97	27.66	2.99	39.06	24.56	54.00	-29.44	Average
2483.500	48.39	27.66	2.99	39.06	39.98	74.00	-34.02	Peak
2500.000	31.41	27.70	3.01	39.10	23.02	54.00	-30.98	Average
2500.000	41.72	27.70	3.01	39.10	33.33	74.00	-40.67	Peak

Test channel:	Highest	Polarization:	Vertical
---------------	---------	---------------	----------

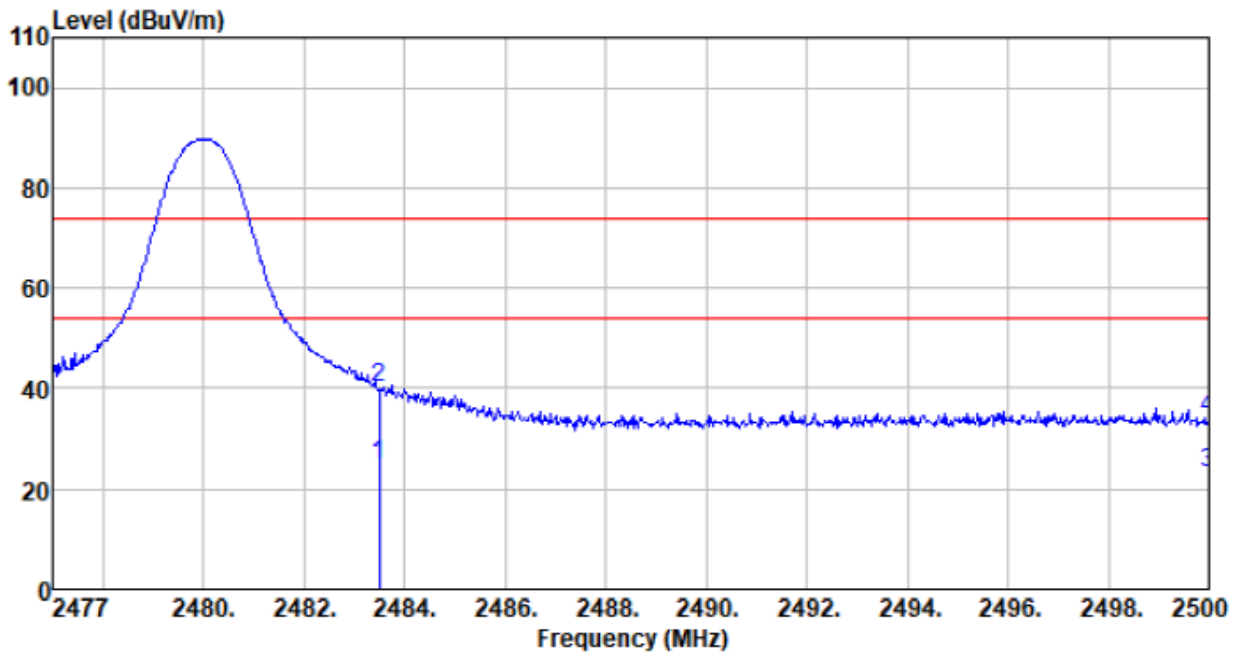

Freq MHz	Reading level dBuV	Antenna factor dB/m	Cable loss dB	Preamp factor dB	level dBuV/m	Limit level dBuV/m	Over limit dB	Remark
2483.500	32.97	27.66	2.99	39.06	24.56	54.00	-29.44	Average
2483.500	48.77	27.66	2.99	39.06	40.36	74.00	-33.64	Peak
2500.000	31.69	27.70	3.01	39.10	23.30	54.00	-30.70	Average
2500.000	42.56	27.70	3.01	39.10	34.17	74.00	-39.83	Peak

Remarks:

1. Final Level = Receiver Read level + Antenna Factor + Cable Loss – Pre-amplifier Factor
2. The emission levels of other frequencies are very lower than the limit and not show in test report.

8 Test Setup Photo

Reference to the **appendix I** for details.

9 EUT Constructional Details

Reference to the **appendix II** for details.

---End---