



**USER MANUAL**



[WWW.REDCATRACING.COM](http://WWW.REDCATRACING.COM)

# **RTX-4C**

**4-CHANNEL RADIO**

## WARNINGS & COMPLIANCE



FCC Compliance Statement! The radio included with your vehicle complies with part 15 of the FCC Rules. Operation is subject to the following two conditions: (1) This device may not cause harmful Interference, and (2) This device must accept any interference received, including interference that may cause undesired operations.

Note: This equipment has been tested and found to comply with the limits for a Class B digital device, pursuant to Part 15 of the FCC Rules. These limits are designed to provide reasonable protection against harmful interference in a residential installation. This equipment generates, uses and can radiate radio frequency energy and, if not installed and used in accordance with the instructions, may cause harmful interference to radio communications. However, there is no guarantee that interference will not occur in a particular installation. If this equipment does cause harmful interference to radio or television reception, which can be determined by turning the equipment off and on, the user is encouraged to try to correct the interference by one of the following measures:

- Reorient or relocate the receiving antenna.
- Increase the separation between the equipment and receiver.
- Connect the equipment into an outlet on a circuit different from that to which the receiver is connected.
- Consult the dealer or an experienced radio/TV technician for help.

TX

FCC ID: 2A2UNRTX4C00

IC: 24025-RTX4C00

This device complies with Industry Canada license-exempt RSS standard(s). Operation is subject to the following two conditions: (1) This device may not cause interference, and (2) this device must accept any interference, including interference that may cause undesired operations of this device.



WARNING: Any changes or modifications not expressly approved by the party responsible for compliance could void the user's authority to operate this equipment.

WARNING: While operating the Radio, a separation distance of at least 20 centimeters must be maintained between the radiating antenna and the body of the user or nearby persons in order to meet the FCC RF exposure guidelines.

AFHDS (automatic frequency hopping digital system)

AFHDS was developed for Radio control models and offers active and passive anti-jamming capabilities, low power consumption and high receiver sensitivity.

This radio system works in the frequency range of 2.408 to 2.475GHz. This band has been divided into 141 independent channels. Each radio system uses 16 different channels and 142 different types of hopping algorithm. By using various switch-on times, hopping scheme, and channel frequencies, the system is less likely to lose transmission.

Each transmitter has a unique ID. When binding with a receiver, the receiver saves that unique ID and can accept only data from that unique transmitter. This avoids picking another transmitter signal and dramatically increases interference immunity and safety.

WARNING: Even with the AFHDS 2A-BS technology, if the radio system is not used in accordance with this manual, it can still fail and cause serious injury. Be sure to read and understand this entire manual, as well as the manual that came with all other RC components you are using.

## WARNINGS & COMPLIANCE

Old electrical appliances must not be disposed of along with regular household residual waste, but have to be disposed of separately. Find a local communal collection point that specializes in the disposal of electrical appliances and devices. These collection points may be free or they may charge a fee, depending on your location. The owner of old or unused appliances is responsible for bringing the appliances to these specialized collection points. With a little personal effort, you can contribute to recycling valuable raw materials and the treatment of toxic substances.

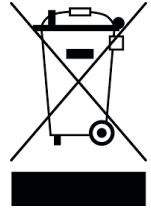

## SPECIFICATIONS

Product Model:	RTX-4C
Channels:	4
Model Type:	Surface Vehicles
RF:	2.4GHz
Maximum Power:	<20dBm (e.i.r.p.) (EU)
2.4GHz Protocol:	2A-BS
Distance:	>300m (Ground)
Channel Resolution:	1024
Battery:	6V DC - (x4) AA Batteries
Low Voltage Warning:	<4.2V
Antenna Type:	Built in Single Antenna
Temperature Range:	-10 deg. C - +60 deg. C
Humidity Range:	20% - 95%
Size:	160 x 193 x 97mm
Weight:	220g
Certification:	CE, FCC ID: N4ZG4P00

## INSTALL TRANSMITTER BATTERIES

**WARNING!** When installing transmitter batteries, be sure the positive and negative polarity is oriented correctly. The negative side of the battery will contact the spring inside the radio tray. See image below.

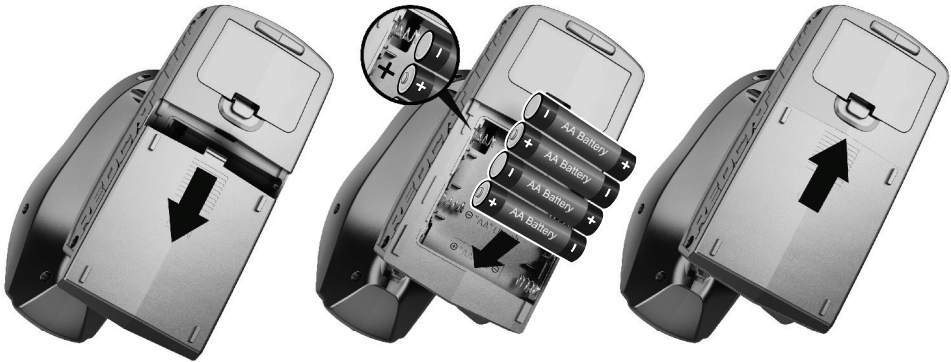

**WARNING!** Do not mix old and new batteries. Do not mix alkaline, lithium, standard (carbon zinc), or rechargeable (Nickel-cadmium) batteries. Do not change or charge batteries in a hazardous location.

**NOTE:** There is a storage compartment in the bottom of the transmitter. This can be used to store (1) mini cross wrench (4-7mm), (4) 4mm nylock nuts and body clips.



# OVERVIEW

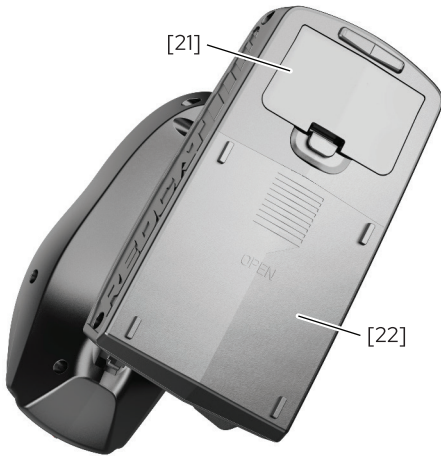
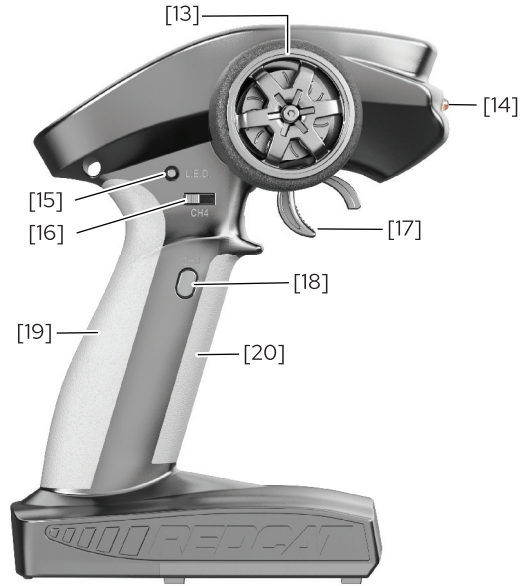
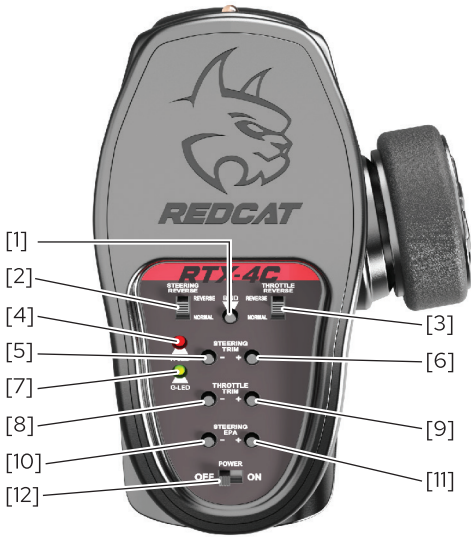

1. Bind Button
2. Steering Reverse
3. Throttle Reverse
4. Power Indicator LED - RED (R. LED)
5. Steering Trim (-)
6. Steering Trim (+)
7. Status Indicator LED - Green (G.LED)
8. Throttle Trim (-)
9. Throttle Trim (+)
10. Steering End Point Adjustment (-) (EPA)
11. Steering End Point Adjustment (+) (EPA)
12. Power Switch
13. Steering Wheel. (CH1)
14. LED Light
15. LED Light (ON/OFF) Button
16. Three Position Switch (CH4)
17. Throttle Trigger (CH2)
18. Button (CH3)
19. Rubber Grip Rear
20. Rubber Grip Front
21. Tool & Spare Parts Compartment
22. Battery Compartment - 4 AA Batteries

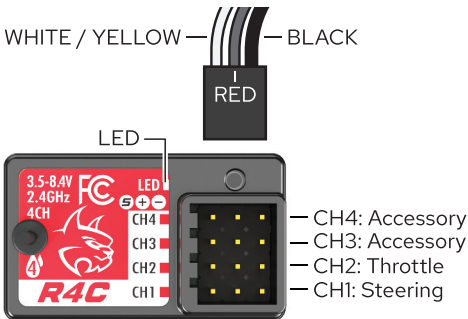

## TURN ON/OFF

### TURN ON:

**Warning!** Always turn on the transmitter BEFORE powering on the vehicle.

1. Be sure four new AA batteries are installed correctly into the transmitter.
2. Turn on the transmitter by moving the ON/OFF switch to the ON position. The red LED will light up when the transmitter is on.
3. Plug a fully charged battery into the ESC and power on the vehicle.

### TURN OFF:

**Warning!** Always turn off the vehicle BEFORE turning off the transmitter.

1. Turn off the vehicle and unplug the battery pack.
2. Turn off the transmitter by setting the ON/OFF switch to the OFF position.

## BINDING INSTRUCTIONS

Follow the wiring diagram below to install the receiver into the vehicle. CH3 & CH4 can be used for accessories, such as 3-speed transmission servo, winch, etc.

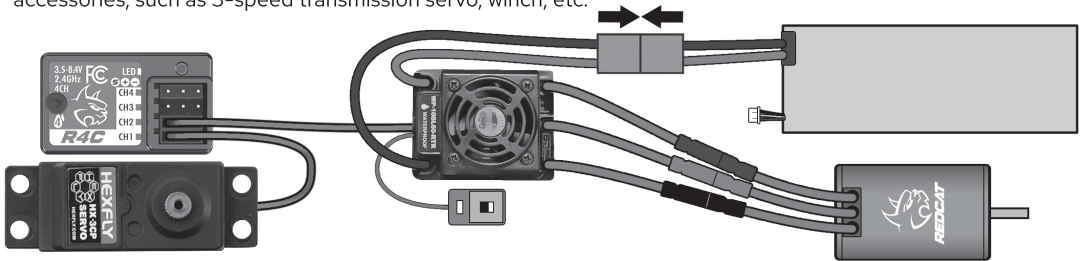

The transmitter and receiver are bound at the factory but if binding is needed, follow these steps.

1. Press and hold the BIND button on the transmitter.
2. While holding the BIND button, turn on the transmitter.
3. The G.LED will start flashing quickly indicating it is in bind mode.
4. Once in bind mode, release the bind button.
5. Turn on the ESC, this will power the receiver. The receiver will enter bind mode automatically when powered on.
6. Turn off the transmitter.
7. Turn the transmitter back on. After the power cycle the transmitter will bind to the receiver. Once binding is successful the receiver's LED will flash slowly and the transmitter's LED will remain solid.

**Note:** When binding, put the transmitter into bind mode first, then power on the receiver.

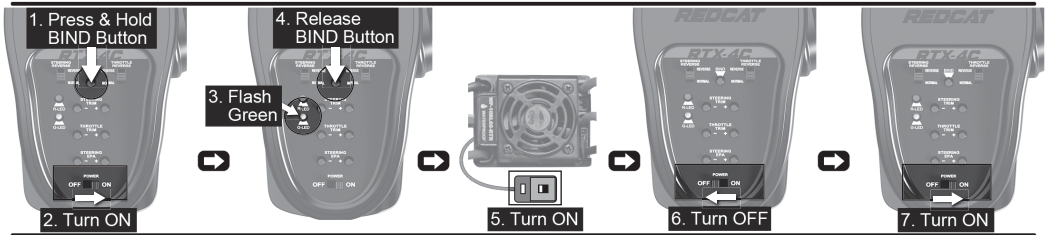

## CALIBRATION

This function is used to set the neutral position for the throttle trigger and steering wheel.

Every transmitter is calibrated before leaving the factory, however if recalibration is required, please follow these steps:

1. Turn and hold the wheel as far clockwise as it will turn, hold the throttle all the way forward and turn on the transmitter. If done correctly, both Red and Green LEDs will double flash on and off.
2. Calibrate wheel: Turn the wheel completely clockwise, then completely counterclockwise.
  - When calibration is completed the Red LED will turn off.
3. Trigger calibration: Pull the trigger back then forward as far as it will go.
  - When calibration is completed the Green LED will turn off.
4. Once calibration is complete press the bind button to save the settings and exit calibration mode.

## FUNCTIONS

### CHANNEL DESCRIPTION

The transmitter outputs a total of 4 channels, which are allocated as follows:

**CH1:** Steering Wheel

**CH2:** Throttle Trigger

**CH3:** Accessory Button (2 Position button)

**CH4:** Accessory Switch (3 Position Switch)

**Note:** By default the output of CH3 is in the position of 1000us. Pressing the button will toggle between 1000 and 2000us.

### CHANNEL REVERSE

This function is used to adjust each channel's direction of movement in relation to its input. The STEERING REVERSE and THROTTLE REVERSE switches directly effect CH1 and CH2. If the switch is up, the channel is reversed. If the switch is down, the channel is in its normal orientation.

### TRIMS

The STEERING TRIM buttons are used to center the steering servo (CH1). If the vehicle steers without transmitter steering input, use these buttons to adjust the vehicle so that it drives straight without steering input from the transmitter. STEERING TRIM can be multiplexed to trim CH3 and CH4. For multiplexing instructions, refer to the [Mode Switching] section.

The THROTTLE TRIM buttons are used to ensure the vehicle remains still while there is no transmitter throttle input (CH2). If the vehicle drives forward or backward without transmitter throttle input, use these buttons to trim the throttle until the vehicle is completely still.

Adjustment range: -120us- + 120us, each step is 4us.

STEERING TRIM + / THROTTLE TRIM +: Increases adjustment steps.

STEERING TRIM- / THROTTLE TRIM -: Decreases adjustment steps.

### **LED Indicator:**

- While using the trim buttons, the G.LED flashes slowly on short presses and quickly on long presses.
- When the trim adjustment value is in the neutral position, the G.LED will flash twice slowly.
- When the trim adjustment value is at its maximum setting (+ 120us / -120us), the G.LED will no longer flash with each press of the button, indicating it is at its maximum value.

### END POINT ADJUSTMENTS (EPA)

STEERING EPA is used to set the steering servo's maximum amount of travel. This is used to ensure the steering servo provides enough throw to steer the front wheels to their maximum capacity without damaging the servo. To set the steering end points, press the "STEERING EPA (-)" button several times, then turn and hold the transmitter's steering wheel all the way to one side. Gradually press the "STEERING EPA (+)" button

## FUNCTIONS

until the front wheels have reached their maximum steering capacity. If you hear the steering servo buzzing, press the "STEERING EPA (-)" until the buzzing stops.

The end point adjustments can be multiplexed to adjust CH2 (throttle), CH3 and CH4. For multiplexing instructions, refer to the [Mode Switching] section.

Adjustment range: 0-120% (the default is 100%), the step value is 5%.

STEERING EPA +: Increases servo travel.

STEERING EPA -: Decreases servo travel.

### LED Indicator:

- When using the trim keys the G.LED will flash slowly on short presses and quickly on long presses.
- When the end point adjustment value is at its maximum setting, the G.LED will no longer flash with each press of the button.

## MODE SWITCHING

This function is for reusing the STEERING TRIM and STEERING EPA buttons for different channels. Refer to the [Trims] and [END POINT ADJUSTMENTS (EPA)] sections on the previous page to view their effect on the vehicle.

### Function settings:

After turning on the transmitter, quickly press the Bind button twice (within 1 second) to cycle through modes 1, 2, 3, and 4. The default setting when powered on is mode 1.

**Mode 1:** G.LED flashes slowly once, STEERING TRIM adjusts CH1 and STEERING EPA adjusts CH1.

**Mode 2:** G.LED flashes twice slowly, STEERING TRIM adjusts CH1 and STEERING EPA adjusts CH2.

**Mode 3:** G.LED flashes three times slowly, STEERING TRIM adjusts CH3 and STEERING EPA adjusts CH3.

**Mode 4:** G.LED flashes slowly four times, STEERING TRIM adjusts CH4 and STEERING EPA adjusts CH4.

## FAILSAFE

This function dictates what the receiver will do in the event that it loses signal from the transmitter, this includes servo position, throttle position, etc.

### Function settings:

1. Turn on the transmitter and make sure it is connected to the receiver.
2. Hold the control surface at the desired failsafe position.
3. Press and hold the bind button for 3 seconds, the G.LED will flash for 2 seconds, indicating that the settings were saved.

**Note:** The failsafe function is not set at the factory by default. If no failsafe setting has been set, the receiver will maintain the output of the last signal when the signal is lost. Failsafe is intended as a safety measure during transmitter signal loss and will not work if the receiver loses power.

## BEGINNER MODE

Beginner mode is designed for the people who are new to the hobby.

In this mode the throttle is limited to 50 percent and the channel range defaults are set to 1250~1500~1750us.

### Function settings:

To switch between beginner and normal modes, press and hold the CH3 button while turning the steering wheel completely counterclockwise, as far as it can go. While holding, turn on the transmitter.

**Note:** By default, the system is set to normal mode. When set to beginner mode, the G.LED will double flash for 3 seconds after turning on the transmitter.



**[www.redcatracing.com](http://www.redcatracing.com)**

Follow us on social media

Take a photo, create a video, post and share your Redcat experience.

Stay up to date on the latest Redcat news, products, and creative content. While these profiles are not customer service channels, you might find that one of our subject experts or another member of the community is able to assist you. If you have an issue or need technical and or product support, please reach out to Redcat directly through our website.

 <https://www.facebook.com/RedcatRacing>

 <https://www.instagram.com/RedcatRacing>

 <https://www.youtube.com/RedcatRacing>

 <https://twitter.com/RedcatRacing>

 <https://www.pinterest.com/RedcatRacing>