

TEST REPORT

Applicant: ShenZhen FLYSKY Technology Co.,Ltd
Address of Applicant: 16F, Huafeng Building, No. 6006 Shennan Road, Futian District, Shenzhen, Guangdong, China
Manufacturer: ShenZhen FLYSKY Technology Co.,Ltd
Address of Manufacturer: 16F, Huafeng Building, No. 6006 Shennan Road, Futian District, Shenzhen, Guangdong, China
Factory: Dongguan Flysky RC Model technology Co.,Ltd
Address of Factory: West building 3, HuangjinyuanInd Park, Qiaoli North Gate, Changping Town, Dongguan, China

Equipment Under Test (EUT)

Product Name: 4-CHANNEL RECEIVER
Model No.: FS-R4D-ESC
Trade Mark: FLYSKY
FCC ID: 2A2UNR4DESC
Applicable standards: FCC CFR Title 47 Part 15 Subpart C Section 15.247
Date of sample receipt: March 01, 2023
Date of Test: March 02-21, 2023
Date of report issued: March 22, 2023
Test Result : PASS *

* In the configuration tested, the EUT complied with the standards specified above.

Authorized Signature:



Robinson Luo
Laboratory Manager

2 Version

Version No.	Date	Description
00	March 22, 2023	Original

Prepared By:

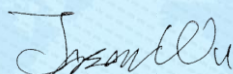

Date:

March 22, 2023

Project Engineer

Check By:

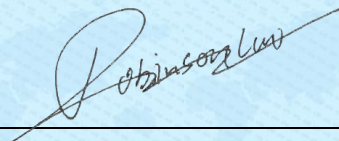

Date:

March 22, 2023

Reviewer

3 Contents

Page

1	COVER PAGE	1
2	VERSION	2
3	CONTENTS	3
4	TEST SUMMARY	4
4.1	MEASUREMENT UNCERTAINTY	4
5	GENERAL INFORMATION	5
5.1	GENERAL DESCRIPTION OF EUT	5
5.2	TEST MODE	7
5.3	TEST FACILITY.....	7
5.4	TEST LOCATION	7
5.5	DESCRIPTION OF SUPPORT UNITS	7
5.6	DEVIATION FROM STANDARDS.....	7
5.7	ABNORMALITIES FROM STANDARD CONDITIONS.....	7
5.8	ADDITIONAL INSTRUCTIONS.....	7
6	TEST INSTRUMENTS LIST	8
7	TEST RESULTS AND MEASUREMENT DATA.....	10
7.1	ANTENNA REQUIREMENT	10
7.2	CONDUCTED EMISSIONS	11
7.3	CONDUCTED PEAK OUTPUT POWER	14
7.4	20dB EMISSION BANDWIDTH	15
7.5	CARRIER FREQUENCIES SEPARATION.....	16
7.6	HOPPING CHANNEL NUMBER	17
7.7	DWELL TIME.....	18
7.8	SPURIOUS EMISSION IN NON-RESTRICTED & RESTRICTED BANDS	19
7.8.1	Conducted Emission Method.....	19
7.8.2	Radiated Emission Method.....	20
8	TEST SETUP PHOTO	39
9	EUT CONSTRUCTIONAL DETAILS	39

4 Test Summary

Test Item	Section	Result
Antenna Requirement	15.203/15.247 (c)	Pass
AC Power Line Conducted Emission	15.207	Pass
Conducted Peak Output Power	15.247 (b)(1)	Pass
20dB Occupied Bandwidth	15.247 (a)(1)	Pass
Carrier Frequencies Separation	15.247 (a)(1)	Pass
Hopping Channel Number	15.247 (a)(1)(iii)	Pass
Dwell Time	15.247 (a)(1)(iii)	Pass
Radiated Emission	15.205/15.209	Pass
Band Edge	15.247(d)	Pass

Pass: The EUT complies with the essential requirements in the standard.

Remark : Test according to ANSI C63.10:2013 .

4.1 Measurement Uncertainty

Test Item	Frequency Range	Measurement Uncertainty	Notes
Radiated Emission	9kHz-30MHz	3.1dB	(1)
Radiated Emission	30MHz-200MHz	3.8039dB	(1)
Radiated Emission	200MHz-1GHz	3.9679dB	(1)
Radiated Emission	1GHz-18GHz	4.29dB	(1)
Radiated Emission	18GHz-40GHz	3.30dB	(1)
AC Power Line Conducted Emission	0.15MHz ~ 30MHz	3.44dB	(1)

Note (1): The measurement uncertainty is for coverage factor of k=2 and a level of confidence of 95%.

5 General Information

5.1 General Description of EUT

Product Name:	4-CHANNEL RECEIVER
Model No.:	FS-R4D-ESC
Serial No.:	RD1001455
Hardware version:	V1.2
Software version:	V1.0.9
Test sample(s) ID:	GTS2023030012-1
Sample(s) Status	Engineer sample
Operation Frequency:	2406MHz~2472MHz
Channel numbers:	133
Modulation method:	FHSS
Modulation technology:	GMSK
Antenna Type:	Coaxial antenna
Antenna gain:	-1.11dBi
Power supply:	DC 6V~13.2V

Remark: The system works in the frequency range of 2406MHz to 2472MHz. This band has been divided to 133 independent channels. Each radio system uses 20 different channels; the minimum channel separation is ≥ 3 MHz. By using various switch-on times, hopping scheme and channel frequencies, the system can guarantee a jamming free radio transmission. Pre-testing all radio systems, this radio system recorded in the report is the worst mode. The channel list is below.

The test frequencies are below:

Channel	Frequency
The lowest channel	2406MHz
The middle channel	2440MHz
The Highest channel	2472MHz

Operation Frequency each of channel							
Channel	Frequency (MHz)	Channel	Frequency (MHz)	Channel	Frequency (MHz)	Channel	Frequency (MHz)
1	2406	36	2423.5	71	2441	106	2458.5
2	2406.5	37	2424	72	2441.5	107	2459
3	2407	38	2424.5	73	2442	108	2459.5
4	2407.5	39	2425	74	2442.5	109	2460
5	2408	40	2425.5	75	2443	110	2460.5
6	2408.5	41	2426	76	2443.5	111	2461
7	2409	42	2426.5	77	2444	112	2461.5
8	2409.5	43	2427	78	2444.5	113	2462
9	2410	44	2427.5	79	2445	114	2462.5
10	2410.5	45	2428	80	2445.5	115	2463
11	2411	46	2428.5	81	2446	116	2463.5
12	2411.5	47	2429	82	2446.5	117	2464
13	2412	48	2429.5	83	2447	118	2464.5
14	2412.5	49	2430	84	2447.5	119	2465
15	2413	50	2430.5	85	2448	120	2465.5
16	2413.5	51	2431	86	2448.5	121	2466
17	2414	52	2431.5	87	2449	122	2466.5
18	2414.5	53	2432	88	2449.5	123	2467
19	2415	54	2432.5	89	2450	124	2467.5
20	2415.5	55	2433	90	2450.5	125	2468
21	2416	56	2433.5	91	2451	126	2468.5
22	2416.5	57	2434	92	2451.5	127	2469
23	2417	58	2434.5	93	2452	128	2469.5
24	2417.5	59	2435	94	2452.5	129	2470
25	2418	60	2435.5	95	2453	130	2470.5
26	2418.5	61	2436	96	2453.5	131	2471
27	2419	62	2436.5	97	2454	132	2471.5
28	2419.5	63	2437	98	2454.5	133	2472
29	2420	64	2437.5	99	2455		
30	2420.5	65	2438	100	2455.5		
31	2421	66	2438.5	101	2456		
32	2421.5	67	2439	102	2456.5		
33	2422	68	2439.5	103	2457		
34	2422.5	69	2440	104	2457.5		
35	2423	70	2440.5	105	2458		

5.2 Test mode

Transmitting mode	Keep the EUT in transmitting mode.
Remark: During the test, the duty cycle >98%, the test voltage is adjusted from DC6V to DC13.2V, and found that the worst case was DC13.2V. So the report just shows that condition's data.	

5.3 Test Facility

<p>The test facility is recognized, certified, or accredited by the following organizations:</p> <ul style="list-style-type: none"> ● FCC —Registration No.: 381383 Designation Number: CN5029 Global United Technology Services Co., Ltd., Shenzhen EMC Laboratory has been registered and fully described in a report filed with the (FCC) Federal Communications Commission. The acceptance letter from the FCC is maintained in files. ● IC —Registration No.: 9079A CAB identifier: CN0091 The 3m Semi-anechoic chamber of Global United Technology Services Co., Ltd. has been registered by Certification and Engineering Bureau of Industry Canada for radio equipment testing. ● NVLAP (LAB CODE:600179-0) Global United Technology Services Co., Ltd., is accredited by the National Voluntary Laboratory Accreditation Program (NVLAP).
--

5.4 Test Location

All other tests were performed at:
<p>Global United Technology Services Co., Ltd. Address: No. 123-128, Tower A, Jinyuan Business Building, No.2, Laodong Industrial Zone, Xixiang Road, Baoan District, Shenzhen, Guangdong, China 518102 Tel: 0755-27798480 Fax: 0755-27798960</p>

5.5 Description of Support Units

Manufacturer	Description	Model	Serial Number
ShenZhen FLYSKY Technology Co.,Ltd	Remote control	G7P	N/A
GW	DC POWER SUPPLY	GPR-6030D	EF924756

5.6 Deviation from Standards

None.

5.7 Abnormalities from Standard Conditions

None.

5.8 Additional Instructions

Software (Used for test) from client
Built-in by manufacturer, power set default.

6 Test Instruments list

Radiated Emission:						
Item	Test Equipment	Manufacturer	Model No.	Inventory No.	Cal.Date (mm-dd-yy)	Cal.Due date (mm-dd-yy)
1	3m Semi- Anechoic Chamber	ZhongYu Electron	9.2(L)*6.2(W)* 6.4(H)	GTS250	July 02, 2020	July 01, 2025
2	Control Room	ZhongYu Electron	6.2(L)*2.5(W)* 2.4(H)	GTS251	N/A	N/A
3	EMI Test Receiver	Rohde & Schwarz	ESU26	GTS203	April 22, 2022	April 21, 2023
4	BiConiLog Antenna	SCHWARZBECK MESS-ELEKTRONIK	VULB9168	GTS640	March 20, 2023	March 19, 2025
5	Double -ridged waveguide horn	SCHWARZBECK MESS-ELEKTRONIK	BBHA 9120 D	GTS208	June 12, 2022	June 11, 2023
6	Horn Antenna	ETS-LINDGREN	3160	GTS217	June 23, 2022	June 22, 2023
7	EMI Test Software	AUDIX	E3	N/A	N/A	N/A
8	Coaxial Cable	GTS	N/A	GTS213	April 22, 2022	April 21, 2023
9	Coaxial Cable	GTS	N/A	GTS211	April 22, 2022	April 21, 2023
10	Coaxial cable	GTS	N/A	GTS210	April 22, 2022	April 21, 2023
11	Coaxial Cable	GTS	N/A	GTS212	April 22, 2022	April 21, 2023
12	Amplifier(100kHz-3GHz)	HP	8347A	GTS204	April 22, 2022	April 21, 2023
13	Amplifier (18-26GHz)	Rohde & Schwarz	AFS33-18002 650-30-8P-44	GTS218	June 23, 2022	June 22, 2023
14	Band filter	Amindeon	82346	GTS219	June 23, 2022	June 22, 2023
15	Power Meter	Anritsu	ML2495A	GTS540	June 23, 2022	June 22, 2023
16	Power Sensor	Anritsu	MA2411B	GTS541	June 23, 2022	June 22, 2023
17	Wideband Radio Communication Tester	Rohde & Schwarz	CMW500	GTS575	April 22, 2022	April 21, 2023
18	Splitter	Agilent	11636B	GTS237	June 23, 2022	June 22, 2023
19	Loop Antenna	ZHINAN	ZN30900A	GTS534	Nov. 29, 2022	Nov. 28, 2023
20	Broadband Preamplifier	SCHWARZBECK	BBV9718	GTS535	April 22, 2022	April 21, 2023
21	Breitband hornantenna	SCHWARZBECK	BBHA 9170	GTS579	Oct. 16, 2022	Oct. 15, 2023
22	Amplifier	TDK	PA-02-02	GTS574	Oct. 16, 2022	Oct. 15, 2023
23	Amplifier	TDK	PA-02-03	GTS576	Oct. 16, 2022	Oct. 15, 2023
24	PSA Series Spectrum Analyzer	Rohde & Schwarz	FSP	GTS578	June 23, 2022	June 22, 2023
25	Amplifier(1GHz-26.5GHz)	HP	8449B	GTS601	April 22, 2022	April 21, 2023

RF Conducted Test:						
Item	Test Equipment	Manufacturer	Model No.	Serial No.	Cal.Date (mm-dd-yy)	Cal.Due date (mm-dd-yy)
1	MXA Signal Analyzer	Agilent	N9020A	GTS566	April 22, 2022	April 21, 2023
2	EMI Test Receiver	R&S	ESCI 7	GTS552	April 22, 2022	April 21, 2023
3	Spectrum Analyzer	Agilent	E4440A	GTS536	April 22, 2022	April 21, 2023
4	MXG vector Signal Generator	Agilent	N5182A	GTS567	April 22, 2022	April 21, 2023
5	ESG Analog Signal Generator	Agilent	E4428C	GTS568	April 22, 2022	April 21, 2023
6	USB RF Power Sensor	DARE	RPR3006W	GTS569	April 22, 2022	April 21, 2023
7	RF Switch Box	Shongyi	RFSW3003328	GTS571	April 22, 2022	April 21, 2023
8	Programmable Constant Temp & Humi Test Chamber	WEWON	WHTH-150L-40-880	GTS572	April 22, 2022	April 21, 2023

General used equipment:						
Item	Test Equipment	Manufacturer	Model No.	Inventory No.	Cal.Date (mm-dd-yy)	Cal.Due date (mm-dd-yy)
1	Humidity/ Temperature Indicator	KTJ	TA328	GTS243	April 25, 2022	April 24, 2023
2	Barometer	KUMAO	SF132	GTS647	July 26, 2022	July 25, 2023

7 Test results and Measurement Data

7.1 Antenna requirement

Standard requirement:	FCC Part15 C Section 15.203 /247(c)
<p>15.203 requirement:</p> <p>An intentional radiator shall be designed to ensure that no antenna other than that furnished by the responsible party shall be used with the device. The use of a permanently attached antenna or of an antenna that uses a unique coupling to the intentional radiator, the manufacturer may design the unit so that a broken antenna can be replaced by the user, but the use of a standard antenna jack or electrical connector is prohibited.</p> <p>15.247(c) (1)(i) requirement:</p> <p>(i) Systems operating in the 2400-2483.5 MHz band that is used exclusively for fixed. Point-to-point operations may employ transmitting antennas with directional gain greater than 6dBi provided the maximum conducted output power of the intentional radiator is reduced by 1 dB for every 3 dB that the directional gain of the antenna exceeds 6dBi.</p>	
EUT Antenna:	
The antenna is Coaxial antenna, reference to the appendix II for details.	

7.2 Conducted Emissions

Test Requirement:	FCC Part15 C Section 15.207				
Test Method:	ANSI C63.10:2013				
Test Frequency Range:	150KHz to 30MHz				
Class / Severity:	Class B				
Receiver setup:	RBW=9KHz, VBW=30KHz, Sweep time=auto				
Limit:	Frequency range (MHz)	Limit (dBuV)			
			Quasi-peak	Average	
	0.15-0.5	66 to 56*	56 to 46*		
	0.5-5	56	46		
	5-30	60	50		
* Decreases with the logarithm of the frequency.					
Test setup:	<p>Remark E.U.T: Equipment Under Test LISN: Line Impedance Stabilization Network Test table height=0.8m</p>				
Test procedure:	<ol style="list-style-type: none"> 1. The E.U.T and simulators are connected to the main power through a line impedance stabilization network (L.I.S.N.). This provides a 50ohm/50uH coupling impedance for the measuring equipment. 2. The peripheral devices are also connected to the main power through a LISN that provides a 50ohm/50uH coupling impedance with 50ohm termination. (Please refer to the block diagram of the test setup and photographs). 3. Both sides of A.C. line are checked for maximum conducted interference. In order to find the maximum emission, the relative positions of equipment and all of the interface cables must be changed according to ANSI C63.10:2013 on conducted measurement. 				
Test Instruments:	Refer to section 6.0 for details				
Test mode:	Refer to section 5.2 for details				
Test environment:	Temp.:	25 °C	Humid.:	52%	Press.: 1012mbar
Test results:	Pass				

Measurement data

Line:

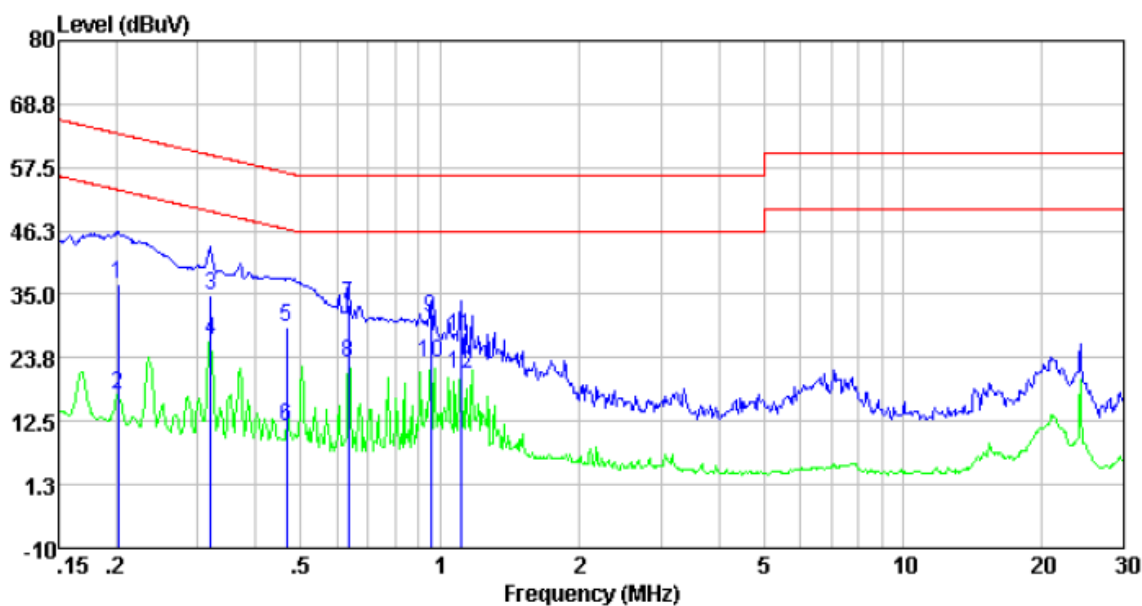

Freq	Reading level	LISN/ISN factor	Cable loss	Limit Level	Over limit	Remark
MHz	dBuV	dB	dB	dBuV	dB	
0.20	26.63	10.05	0.01	36.69	63.54	QP
0.20	7.25	10.05	0.01	17.31	53.54	Average
0.32	24.70	9.98	0.01	34.69	59.71	QP
0.32	16.94	9.98	0.01	26.93	49.71	Average
0.47	19.23	9.96	0.01	29.20	56.58	QP
0.47	1.54	9.96	0.01	11.51	46.58	Average
0.63	23.20	9.96	0.02	33.18	56.00	QP
0.63	12.99	9.96	0.02	22.97	46.00	Average
0.95	20.80	9.96	0.03	30.79	56.00	QP
0.95	12.92	9.96	0.03	22.91	46.00	Average
1.11	17.51	9.94	0.03	27.48	56.00	QP
1.11	10.76	9.94	0.03	20.73	46.00	Average

Neutral:

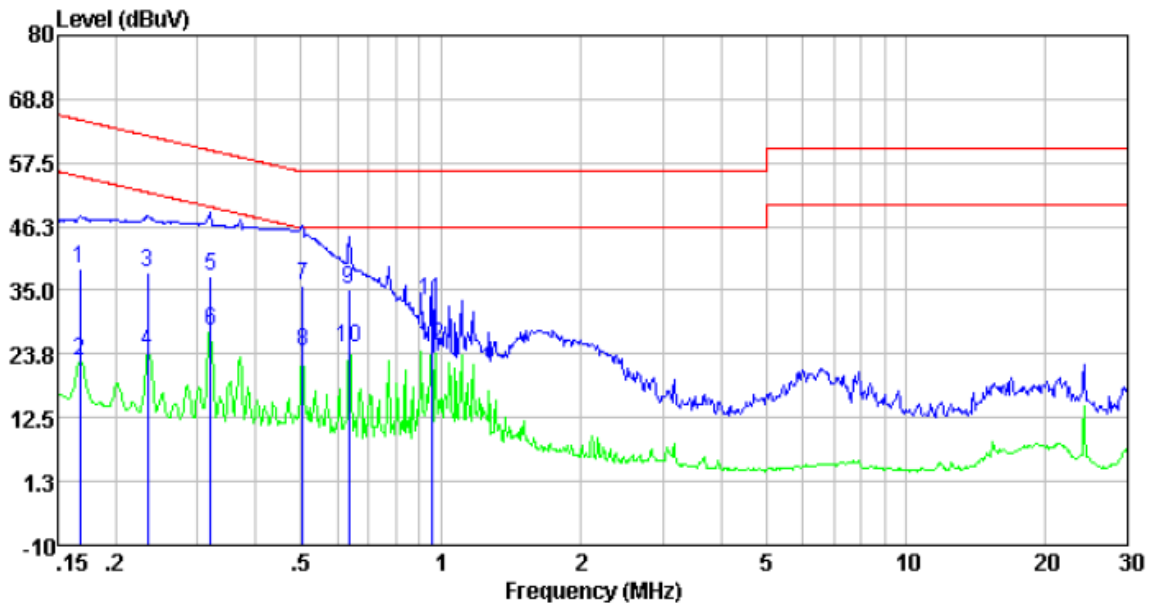

Freq	Reading level	LISN/ISN factor	Cable loss	Level	Limit level	Over limit	Remark
MHz	dBuV	dB	dB	dBuV	dBuV	dB	
0.17	28.83	10.12	0.01	38.96	65.08	-26.12	QP
0.17	12.33	10.12	0.01	22.46	55.08	-32.62	Average
0.23	28.12	10.03	0.01	38.16	62.30	-24.14	QP
0.23	14.08	10.03	0.01	24.12	52.30	-28.18	Average
0.32	27.47	9.97	0.01	37.45	59.71	-22.26	QP
0.32	18.00	9.97	0.01	27.98	49.71	-21.73	Average
0.50	26.02	9.96	0.01	35.99	56.00	-20.01	QP
0.50	14.23	9.96	0.01	24.20	46.00	-21.80	Average
0.63	25.08	9.96	0.02	35.06	56.00	-20.94	QP
0.63	15.05	9.96	0.02	25.03	46.00	-20.97	Average
0.95	23.25	9.96	0.03	33.24	56.00	-22.76	QP
0.95	15.28	9.96	0.03	25.27	46.00	-20.73	Average

Notes:

1. An initial pre-scan was performed on the line and neutral lines with peak detector.
2. Quasi-Peak and Average measurement were performed at the frequencies with maximized peak emission.
3. Final Level = Receiver Read level + LISN Factor + Cable Loss
4. If the average limit is met when using a quasi-peak detector receiver, the EUT shall be deemed to meet both limits and measurement with the average detector receiver is unnecessary.

7.3 Conducted Peak Output Power

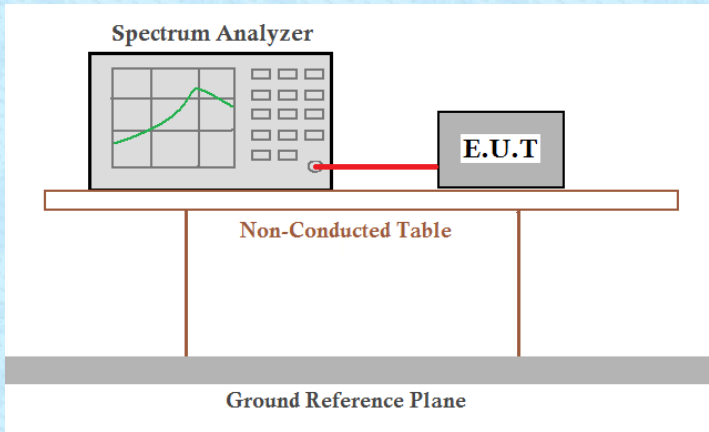
Test Requirement:	FCC Part15 C Section 15.247(a)(1)
Test Method:	ANSI C63.10:2013
Limit:	20.97dBm
Test setup:	 <p>The diagram illustrates the test setup. A Spectrum Analyzer is connected to an E.U.T. (Equipment Under Test) via a red cable. Both are placed on a Non-Conducted Table, which sits on a Ground Reference Plane.</p>
Test Instruments:	Refer to section 6.0 for details
Test mode:	Refer to section 5.2 for details
Test results:	Pass

Measurement Data: The detailed test data see Appendix for 2.4G.

7.4 20dB Emission Bandwidth

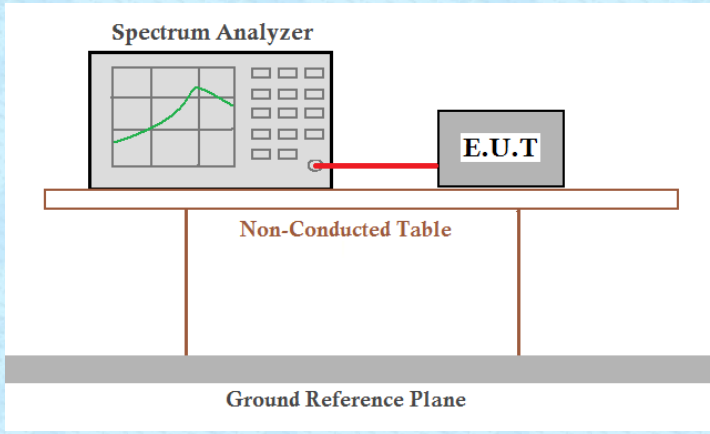
Test Requirement:	FCC Part15 C Section 15.247 (a)(1)
Test Method:	ANSI C63.10:2013
Limit:	N/A
Test setup:	 <p>The diagram illustrates the test setup. A Spectrum Analyzer is connected to an E.U.T. (Equipment Under Test) via a red cable. Both are placed on a Non-Conducted Table, which is supported by a Ground Reference Plane.</p>
Test Instruments:	Refer to section 6.0 for details
Test mode:	Refer to section 5.2 for details
Test results:	Pass

Measurement Data: The detailed test data see Appendix for 2.4G.

7.5 Carrier Frequencies Separation

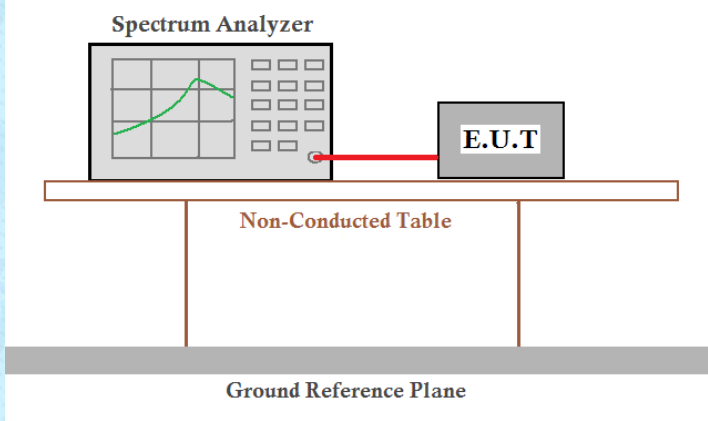
Test Requirement:	FCC Part15 C Section 15.247 (a)(1)
Test Method:	ANSI C63.10:2013
Receiver setup:	RBW=100KHz, VBW=300KHz, detector=Peak
Limit:	0.025MHz or 2/3 of the 20dB bandwidth (whichever is greater)
Test setup:	 <p>The diagram illustrates the test setup. A Spectrum Analyzer is connected to an E.U.T. (Equipment Under Test) via a red cable. Both are placed on a Non-Conducted Table, which is supported by a Ground Reference Plane.</p>
Test Instruments:	Refer to section 6.0 for details
Test mode:	Refer to section 5.2 for details
Test results:	Pass

Measurement Data: The detailed test data see Appendix for 2.4G.

7.6 Hopping Channel Number

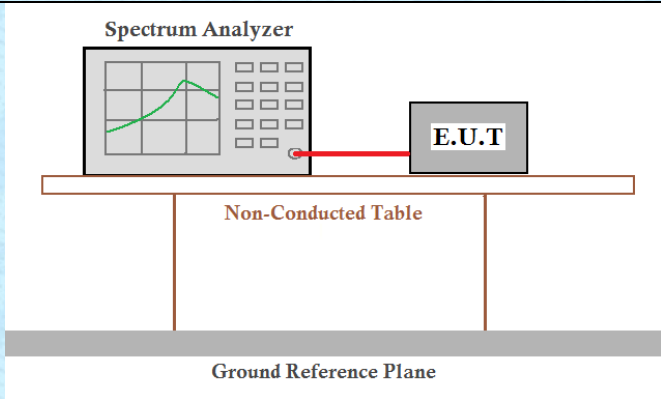
Test Requirement:	FCC Part15 C Section 15.247 (a)(1)(iii)
Test Method:	ANSI C63.10:2013
Receiver setup:	RBW=100kHz, VBW=300kHz, Frequency range=2400MHz-2483.5MHz, Detector=Peak
Limit:	15 channels
Test setup:	 <p>The diagram illustrates the test setup. A Spectrum Analyzer is connected to an E.U.T. (Equipment Under Test) via a red cable. Both are placed on a Non-Conducted Table, which sits on a Ground Reference Plane.</p>
Test Instruments:	Refer to section 6.0 for details
Test mode:	Refer to section 5.2 for details
Test results:	Pass

Measurement Data: The detailed test data see Appendix for 2.4G.

7.7 Dwell Time

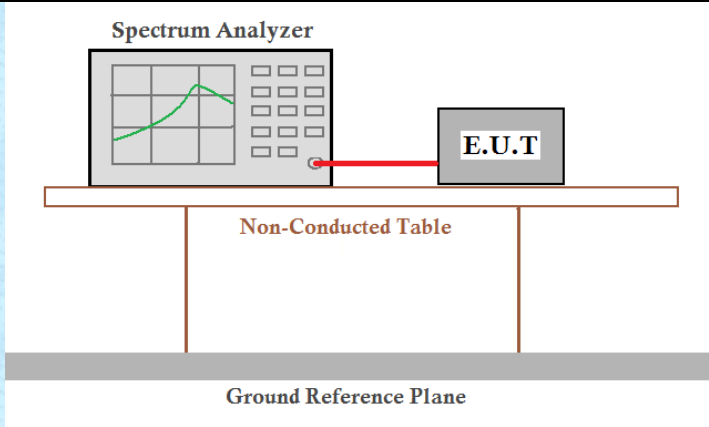
Test Requirement:	FCC Part15 C Section 15.247 (a)(1)(iii)
Test Method:	ANSI C63.10:2013
Receiver setup:	RBW=1MHz, VBW=1MHz, Span=0Hz, Detector=Peak
Limit:	0.4 Second
Test setup:	 <p>The diagram illustrates the test setup. A Spectrum Analyzer is connected to an E.U.T. (Equipment Under Test) via a red cable. Both are placed on a Non-Conducted Table, which is supported by a Ground Reference Plane.</p>
Test Instruments:	Refer to section 6.0 for details
Test mode:	Refer to section 5.2 for details
Test results:	Pass

Measurement Data: The detailed test data see Appendix for 2.4G.

7.8 Spurious Emission in Non-restricted & restricted Bands

7.8.1 Conducted Emission Method

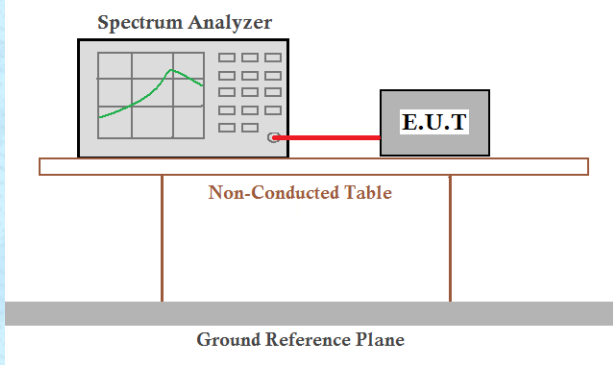
Test Requirement:	FCC Part15 C Section 15.247 (d)
Test Method:	ANSI C63.10:2013
Receiver setup:	RBW=100kHz, VBW=300kHz, Detector=Peak
Limit:	In any 100 kHz bandwidth outside the frequency band in which the spread spectrum intentional radiator is operating, the radio frequency power that is produced by the intentional radiator shall be at least 20 dB below that in the 100 kHz bandwidth within the band that contains the highest level of the desired power, based on either an RF conducted or a radiated measurement.
Test setup:	 <p>The diagram illustrates the test setup. A Spectrum Analyzer is connected to an E.U.T. (Equipment Under Test) via a red cable. Both are placed on a Non-Conducted Table, which sits on a Ground Reference Plane.</p>
Test Instruments:	Refer to section6.0 for details
Test mode:	Refer to section 5.2 for details
Test results:	Pass

Measurement Data: The detailed test data see Appendix for 2.4G.

7.8.2 Radiated Emission Method

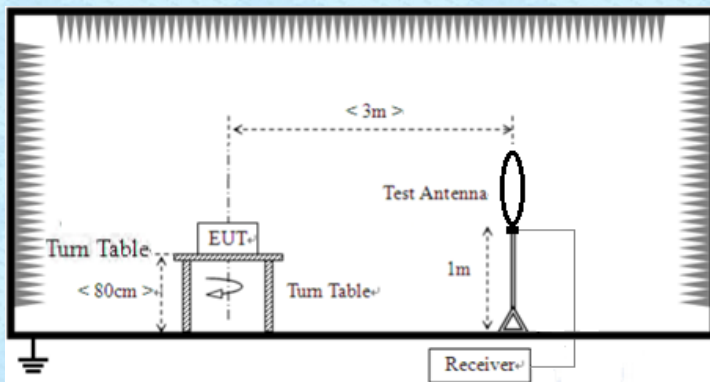
Test Requirement:	FCC Part15 C Section 15.209 and 15.205				
Test Method:	ANSI C63.10:2013				
Test Frequency Range:	9kHz to 25GHz				
Test site:	Measurement Distance: 3m				
Receiver setup:	Frequency	Detector	RBW	VBW	Value
	9KHz-150KHz	Quasi-peak	200Hz	600Hz	Quasi-peak
	150KHz-30MHz	Quasi-peak	9KHz	30KHz	Quasi-peak
	30MHz-1GHz	Quasi-peak	120KHz	300KHz	Quasi-peak
	Above 1GHz	Peak	1MHz	3MHz	Peak
Peak		1MHz	10Hz	Average	
Limit: (Spurious Emissions)	Frequency	Limit (uV/m)	Value	Measurement Distance	
	0.009MHz-0.490MHz	2400/F(KHz)	QP	300m	
	0.490MHz-1.705MHz	24000/F(KHz)	QP	300m	
	1.705MHz-30MHz	30	QP	30m	
	30MHz-88MHz	100	QP	3m	
	88MHz-216MHz	150	QP		
	216MHz-960MHz	200	QP		
	960MHz-1GHz	500	QP		
	Above 1GHz	500	Average		
5000		Peak			
Test setup:	Below 30MHz				
	 <p>Below 1GHz</p>				

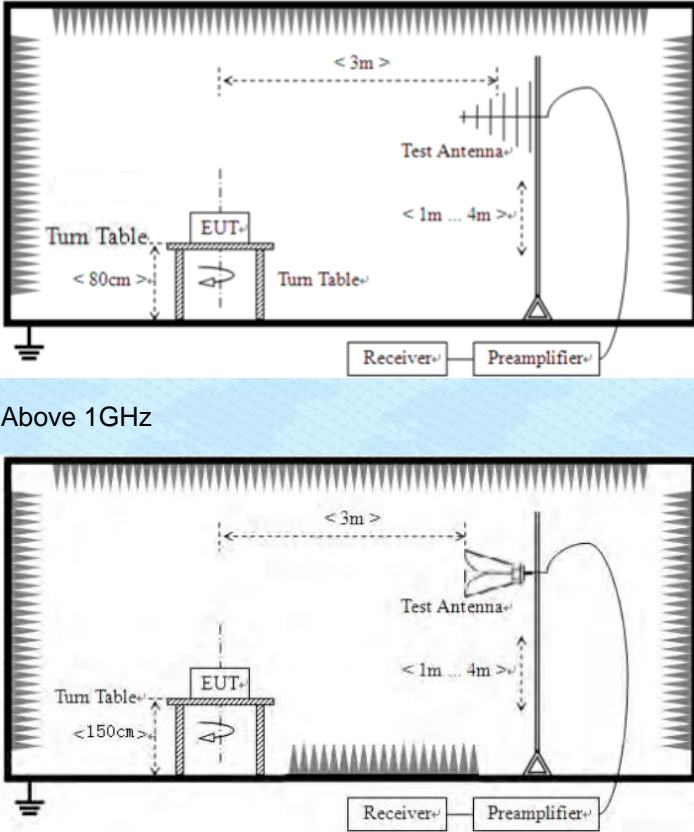
	 <p>Above 1GHz</p>						
<p>Test Procedure:</p>	<ol style="list-style-type: none"> 1. The EUT was placed on the top of a rotating table (0.8 meters for below 1GHz and 1.5meters for above 1GHz) above the ground at a 3 meter camber. The table was rotated 360 degrees to determine the position of the highest radiation. 2. The EUT was set 3 meters away from the interference-receiving antenna, which was mounted on the top of a variable-height antenna tower. 3. The antenna height is varied from one meter to four meters above the ground to determine the maximum value of the field strength. Both horizontal and vertical polarizations of the antenna are set to make the measurement. 4. For each suspected emission, the EUT was arranged to its worst case and then the antenna was tuned to heights from 1 meter to 4 meters and the rota table was turned from 0 degrees to 360 degrees to find the maximum reading. 5. The test-receiver system was set to Peak Detect Function and Specified Bandwidth with Maximum Hold Mode. 6. If the emission level of the EUT in peak mode was 10dB lower than the limit specified, then testing could be stopped and the peak values of the EUT would be reported. Otherwise the emissions that did not have 10dB margin would be re-tested one by one using peak, quasi-peak or average method as specified and then reported in a data sheet. 						
<p>Test Instruments:</p>	<p>Refer to section 5.8 for details</p>						
<p>Test mode:</p>	<p>Refer to section 5.2 for details</p>						
<p>Temp. / Hum.</p>	<table border="1"> <tr> <td>Temp.:</td> <td>25 °C</td> <td>Humid.:</td> <td>52%</td> <td>Press.:</td> <td>1 012mbar</td> </tr> </table>	Temp.:	25 °C	Humid.:	52%	Press.:	1 012mbar
Temp.:	25 °C	Humid.:	52%	Press.:	1 012mbar		

Test results:	Pass
---------------	------

Remark:

1. *Pre-scan all kind of the place mode (X-axis, Y-axis, Z-axis), and found the Y-axis which it is worse case.*

Measurement data:

■ **Below 30MHz**

The low frequency, which started from 9 kHz to 30 MHz, was pre-scanned and the result which was 20 dB lower than the limit line per 15.31(o) was not reported.

30MHz ~ 1GHz

Test channel:	Lowest	Polarization:	Horizontal
---------------	--------	---------------	------------

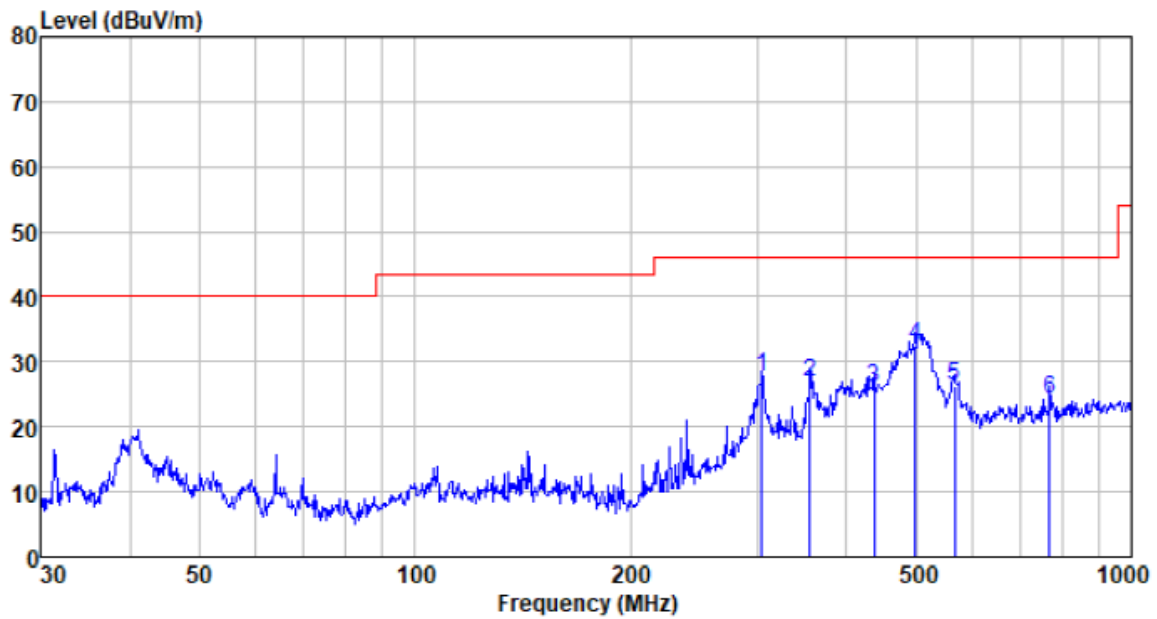

Freq MHz	Reading level dBuV	Antenna factor dB/m	Cable loss dB	Preamp factor dB	level dBuV/m	Limit level dBuV/m	Over limit dB	Remark
304.610	42.75	12.57	2.38	30.00	27.70	46.00	-18.30	QP
355.427	40.00	14.34	2.64	30.00	26.98	46.00	-19.02	QP
437.120	36.43	16.46	3.03	30.00	25.92	46.00	-20.08	QP
499.425	41.61	17.59	3.30	30.00	32.50	46.00	-13.50	QP
566.622	33.82	18.77	3.59	30.00	26.18	46.00	-19.82	QP
768.748	27.80	22.13	4.35	30.00	24.28	46.00	-21.72	QP

Test channel:	Lowest	Polarization:	Vertical
---------------	--------	---------------	----------

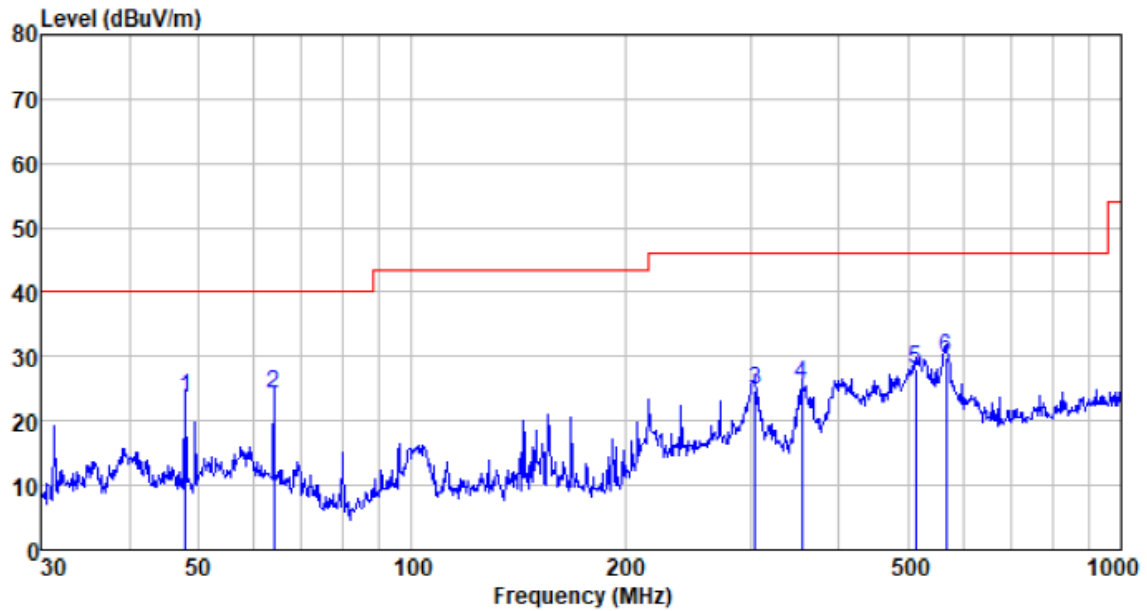

Freq MHz	Reading level dBuV	Antenna factor dB/m	Cable loss dB	Preamp factor dB	level dBuV/m	Limit level dBuV/m	Over limit dB	Remark
47.994	39.75	13.26	0.75	30.00	23.76	40.00	-16.24	QP
63.983	41.51	11.72	0.89	30.00	24.12	40.00	-15.88	QP
304.610	39.89	12.57	2.38	30.00	24.84	46.00	-21.16	QP
354.183	38.70	14.30	2.64	30.00	25.64	46.00	-20.36	QP
513.633	36.70	17.85	3.36	30.00	27.91	46.00	-18.09	QP
566.622	37.44	18.77	3.59	30.00	29.80	46.00	-16.20	QP

Test channel:	Middle	Polarization:	Horizontal
---------------	--------	---------------	------------

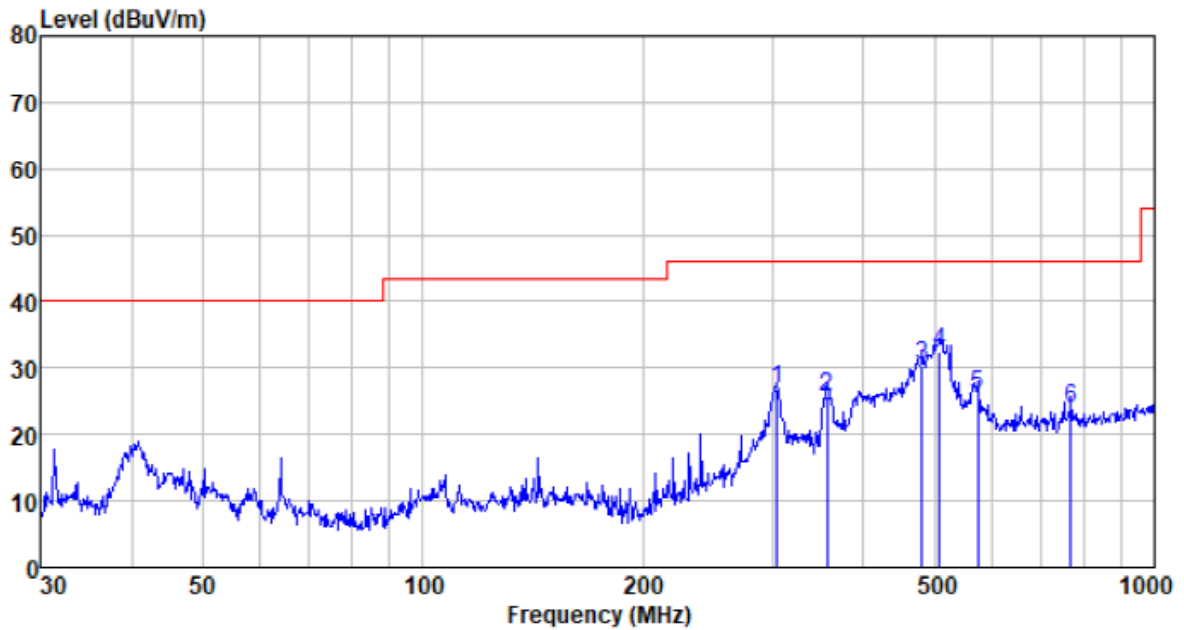

Freq MHz	Reading level dBuV	Antenna factor dB/m	Cable loss dB	Preamp factor dB	level dBuV/m	Limit level dBuV/m	Over limit dB	Remark
304.610	41.81	12.57	2.38	30.00	26.76	46.00	-19.24	QP
356.676	38.72	14.38	2.65	30.00	25.75	46.00	-20.25	QP
480.528	40.05	17.26	3.22	30.00	30.53	46.00	-15.47	QP
508.258	41.50	17.75	3.34	30.00	32.59	46.00	-13.41	QP
572.614	33.64	18.86	3.62	30.00	26.12	46.00	-19.88	QP
768.748	27.35	22.13	4.35	30.00	23.83	46.00	-22.17	QP

Test channel:	Middle	Polarization:	Vertical
---------------	--------	---------------	----------

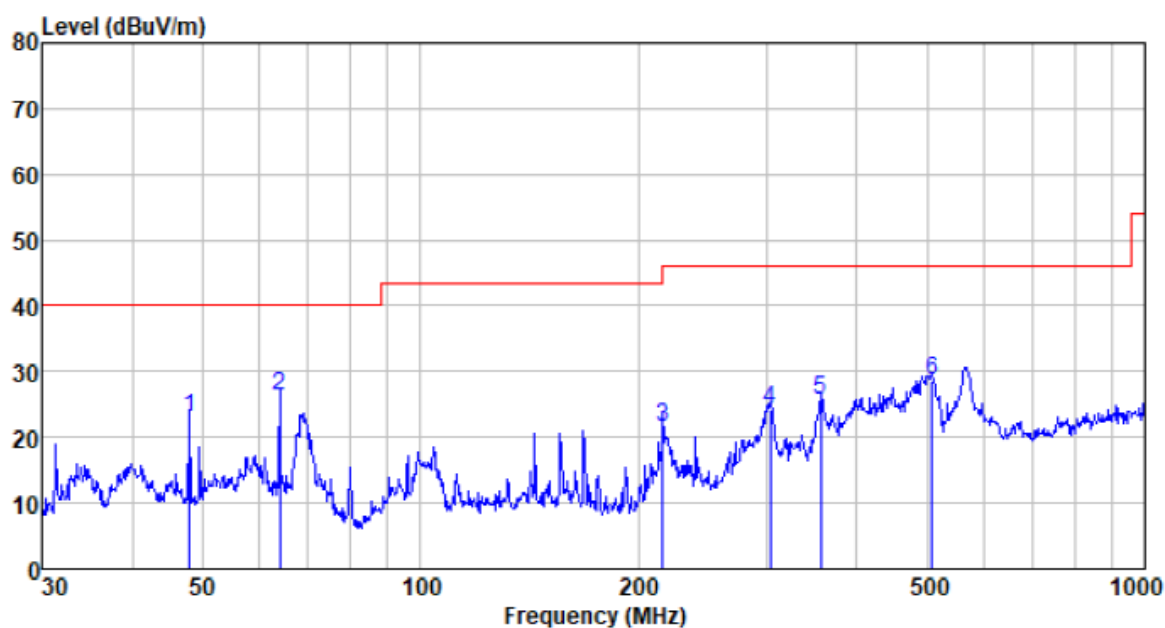

Freq MHz	Reading level dBUV	Antenna factor dB/m	Cable loss dB	Preamp factor dB	level dBUV/m	Limit level dBUV/m	Over limit dB	Remark
47.994	39.09	13.26	0.75	30.00	23.10	40.00	-16.90	QP
63.983	43.68	11.72	0.89	30.00	26.29	40.00	-13.71	QP
216.024	39.56	10.09	1.93	30.00	21.58	46.00	-24.42	QP
303.544	39.38	12.53	2.38	30.00	24.29	46.00	-21.71	QP
356.676	38.64	14.38	2.65	30.00	25.67	46.00	-20.33	QP
508.258	37.44	17.75	3.34	30.00	28.53	46.00	-17.47	QP

Test channel:	Highest	Polarization:	Horizontal
---------------	---------	---------------	------------

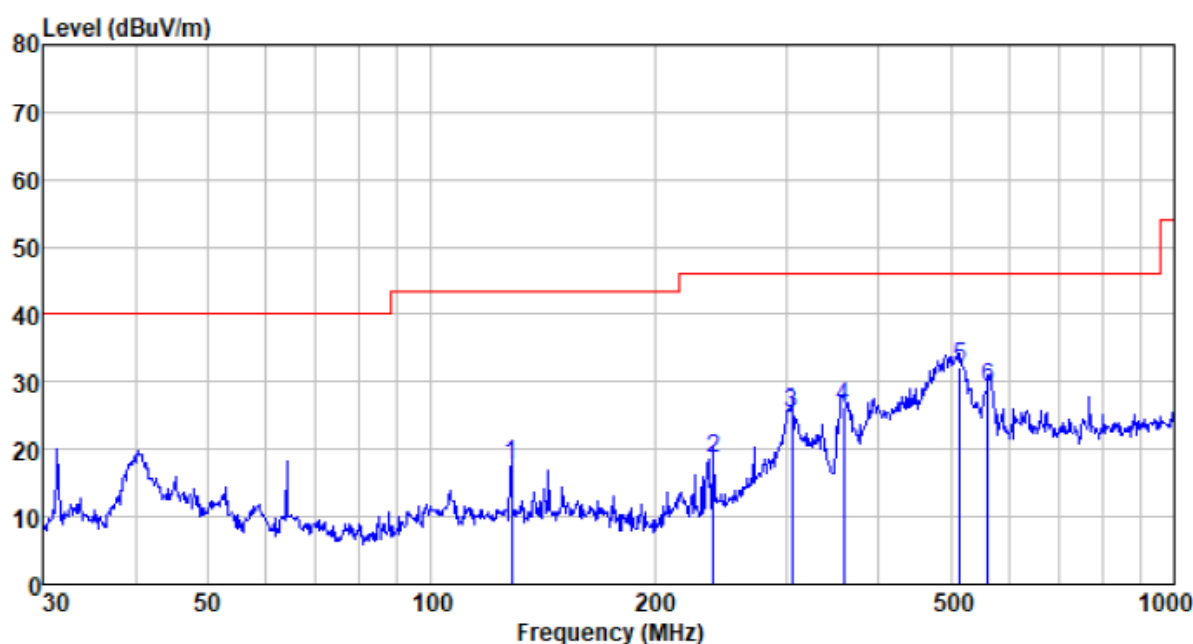

Freq MHz	Reading level dBuV	Antenna factor dB/m	Cable loss dB	Preamp factor dB	level dBuV/m	Limit level dBuV/m	Over limit dB	Remark
128.113	34.66	11.71	1.42	30.00	17.79	43.50	-25.71	QP
239.987	34.82	11.60	2.07	30.00	18.49	46.00	-27.51	QP
305.680	40.30	12.62	2.39	30.00	25.31	46.00	-20.69	QP
359.186	39.22	14.47	2.67	30.00	26.36	46.00	-19.64	QP
515.437	40.90	17.88	3.37	30.00	32.15	46.00	-13.85	QP
560.693	36.86	18.67	3.56	30.00	29.09	46.00	-16.91	QP

Test channel:	Highest	Polarization:	Vertical
---------------	---------	---------------	----------

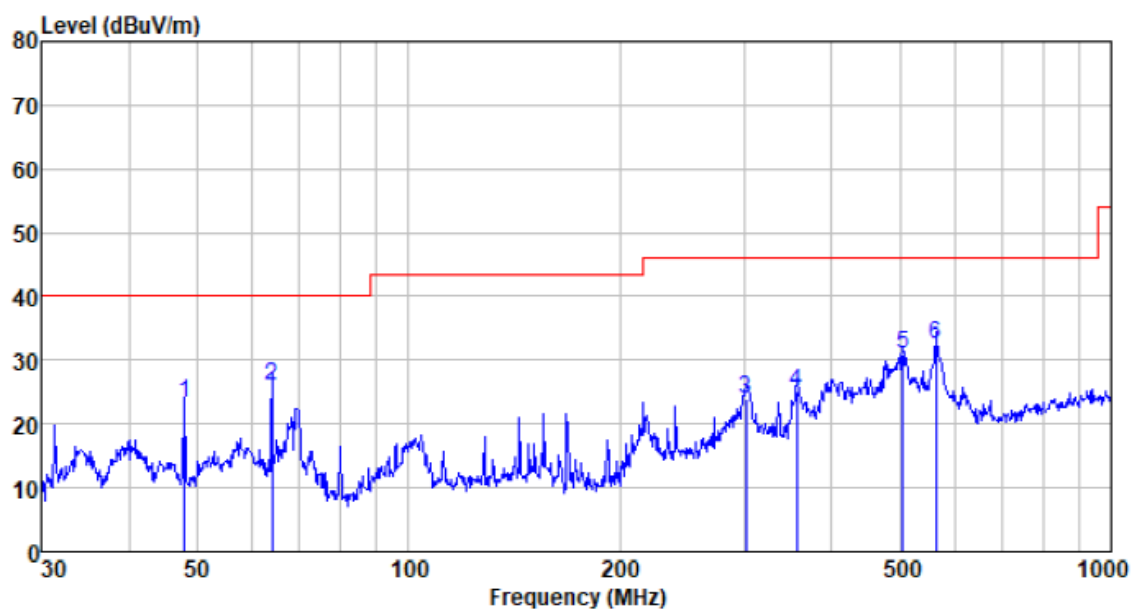

Freq MHz	Reading level dBuV	Antenna factor dB/m	Cable loss dB	Preamp factor dB	level dBuV/m	Limit level dBuV/m	Over limit dB	Remark
47.994	39.31	13.26	0.75	30.00	23.32	40.00	-16.68	QP
63.983	43.29	11.72	0.89	30.00	25.90	40.00	-14.10	QP
302.481	39.01	12.49	2.37	30.00	23.87	46.00	-22.13	QP
356.676	38.03	14.38	2.65	30.00	25.06	46.00	-20.94	QP
504.706	40.02	17.69	3.33	30.00	31.04	46.00	-14.96	QP
562.662	40.24	18.70	3.57	30.00	32.51	46.00	-13.49	QP

- Unwanted Emissions in Restricted Frequency Bands
- Above 1GHz

Test channel:	Lowest	Polarization:	Horizontal
---------------	--------	---------------	------------

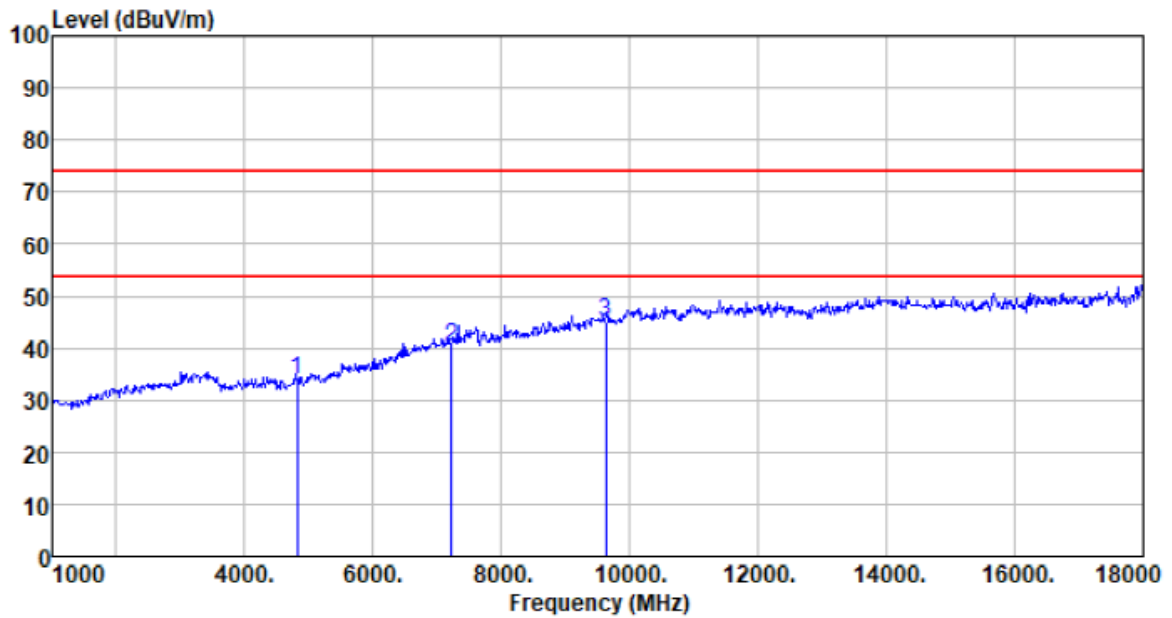

Freq MHz	Reading level dBuV	Antenna factor dB/m	Cable loss dB	Preamp factor dB	level dBuV/m	Limit level dBuV/m	Over limit dB	Remark
4812.000	36.59	31.07	4.61	38.36	33.91	74.00	-40.09	Peak
7218.000	36.93	35.94	6.50	38.97	40.40	74.00	-33.60	Peak
9624.000	38.80	37.92	7.98	39.69	45.01	74.00	-28.99	Peak

Test channel:	Lowest	Polarization:	Vertical
---------------	--------	---------------	----------

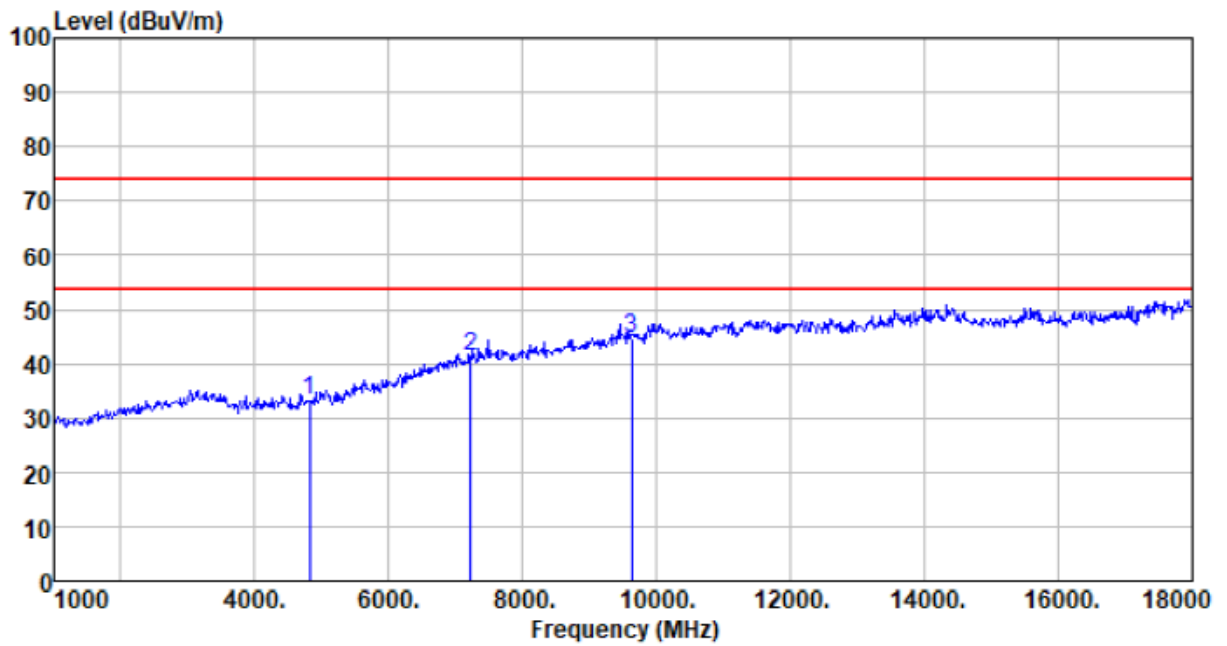

Freq MHz	Reading level dBuV	Antenna factor dB/m	Cable loss dB	Preamp factor dB	level dBuV/m	Limit level dBuV/m	Over limit dB	Remark
4812.000	35.97	31.07	4.61	38.36	33.29	74.00	-40.71	Peak
7216.000	37.70	35.93	6.50	38.96	41.17	74.00	-32.83	Peak
9624.000	38.29	37.92	7.98	39.69	44.50	74.00	-29.50	Peak

Test channel:	Middle	Polarization:	Horizontal
---------------	--------	---------------	------------

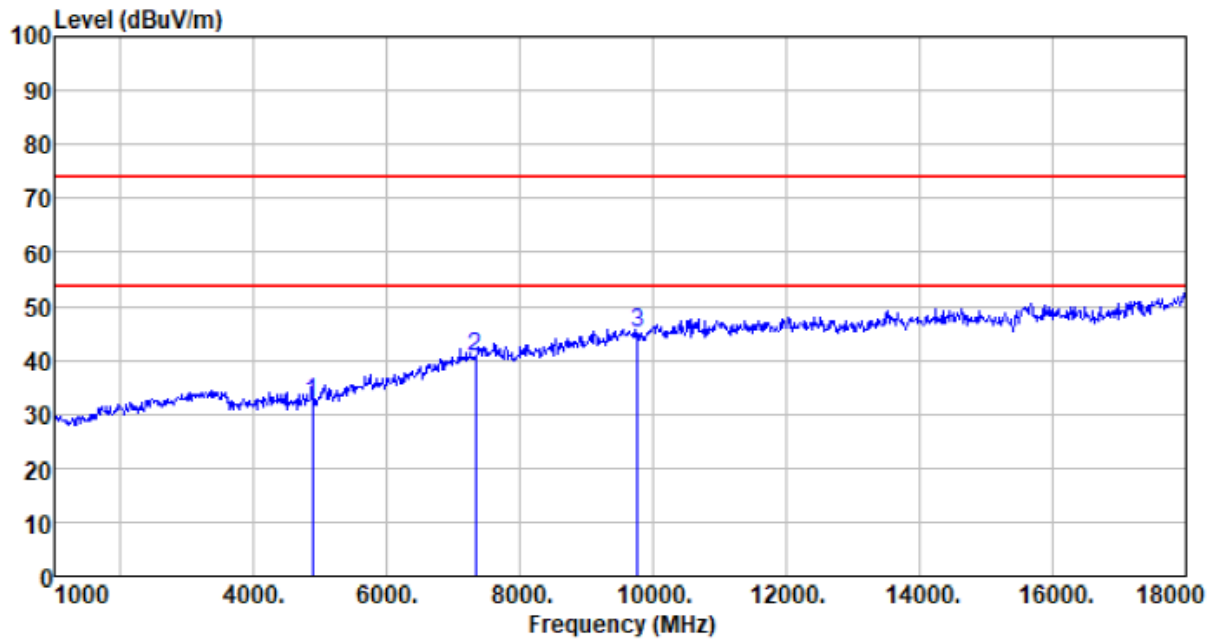

Freq MHz	Reading level dBuV	Antenna factor dB/m	Cable loss dB	Preamp factor dB	level dBuV/m	Limit level dBuV/m	Over limit dB	Remark
4880.000	34.51	31.26	4.69	38.38	32.08	74.00	-41.92	Peak
7320.000	36.82	36.14	6.63	39.00	40.59	74.00	-33.41	Peak
9760.000	38.63	38.06	8.03	39.73	44.99	74.00	-29.01	Peak

Test channel:	Middle	Polarization:	Vertical
---------------	--------	---------------	----------

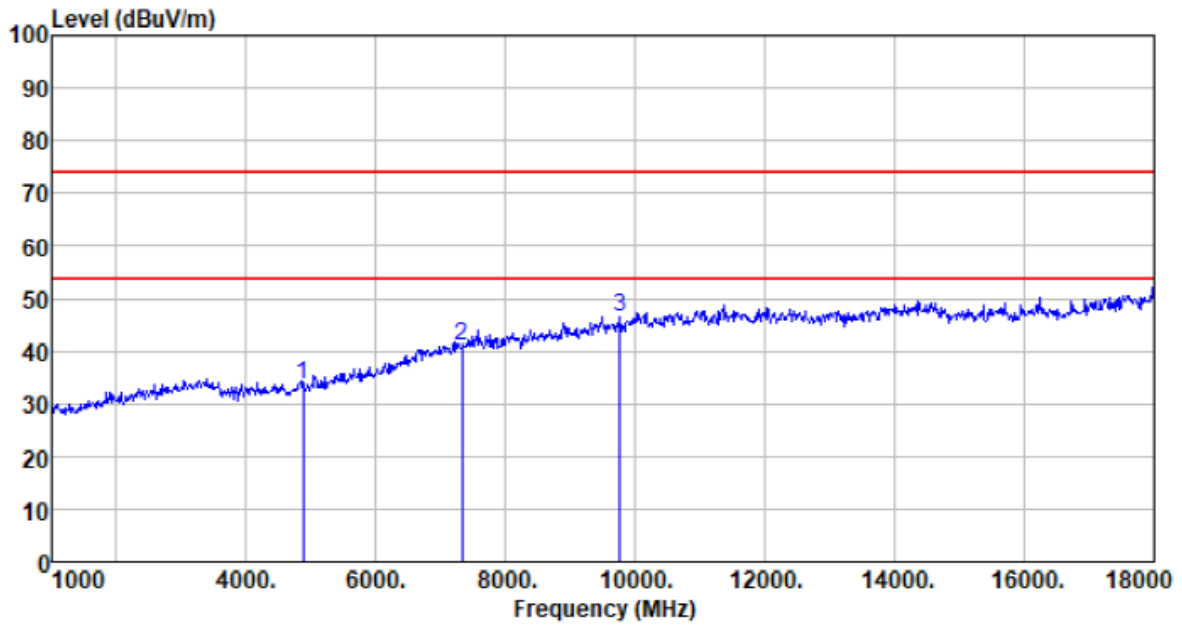

Freq MHz	Reading level dBuV	Antenna factor dB/m	Cable loss dB	Preamp factor dB	level dBuV/m	Limit level dBuV/m	Over limit dB	Remark
4880.000	36.04	31.26	4.69	38.38	33.61	74.00	-40.39	Peak
7320.000	37.30	36.14	6.63	39.00	41.07	74.00	-32.93	Peak
9760.000	40.17	38.06	8.03	39.73	46.53	74.00	-27.47	Peak

Test channel:	Highest	Polarization:	Horizontal
---------------	---------	---------------	------------

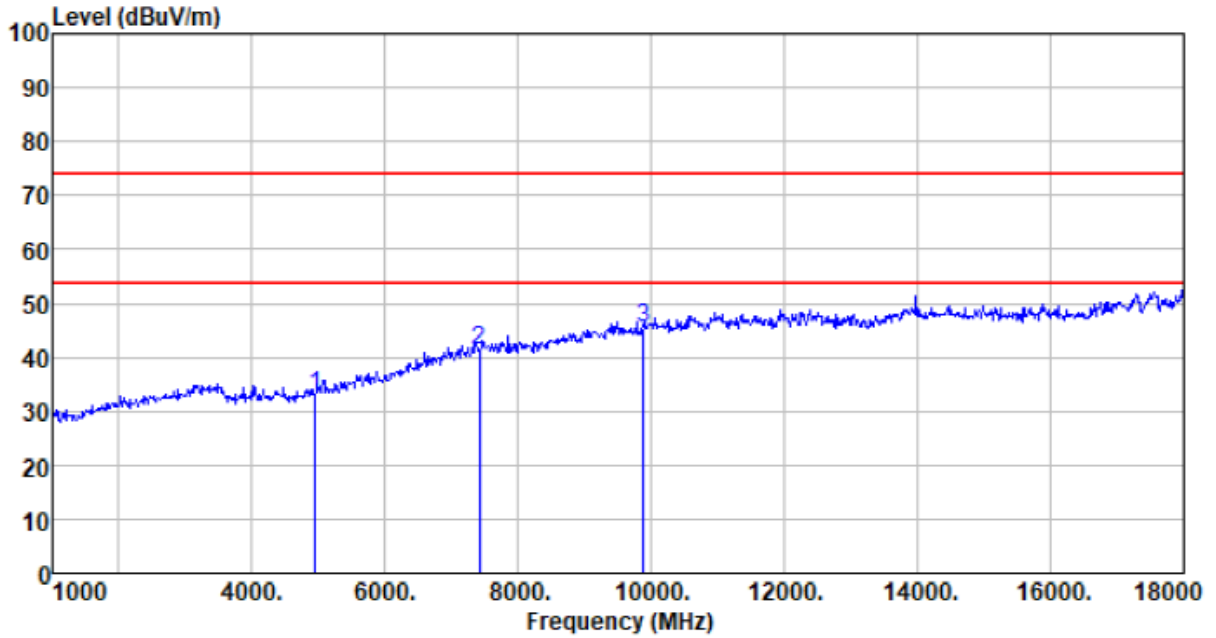

Freq MHz	Reading level dBuV	Antenna factor dB/m	Cable loss dB	Preamp factor dB	level dBuV/m	Limit level dBuV/m	Over limit dB	Remark
4944.000	35.15	31.44	4.77	38.39	32.97	74.00	-41.03	Peak
7416.000	37.26	36.33	6.73	39.02	41.30	74.00	-32.70	Peak
9888.000	38.77	38.19	8.08	39.77	45.27	74.00	-28.73	Peak

Test channel:	Highest	Polarization:	Vertical
---------------	---------	---------------	----------

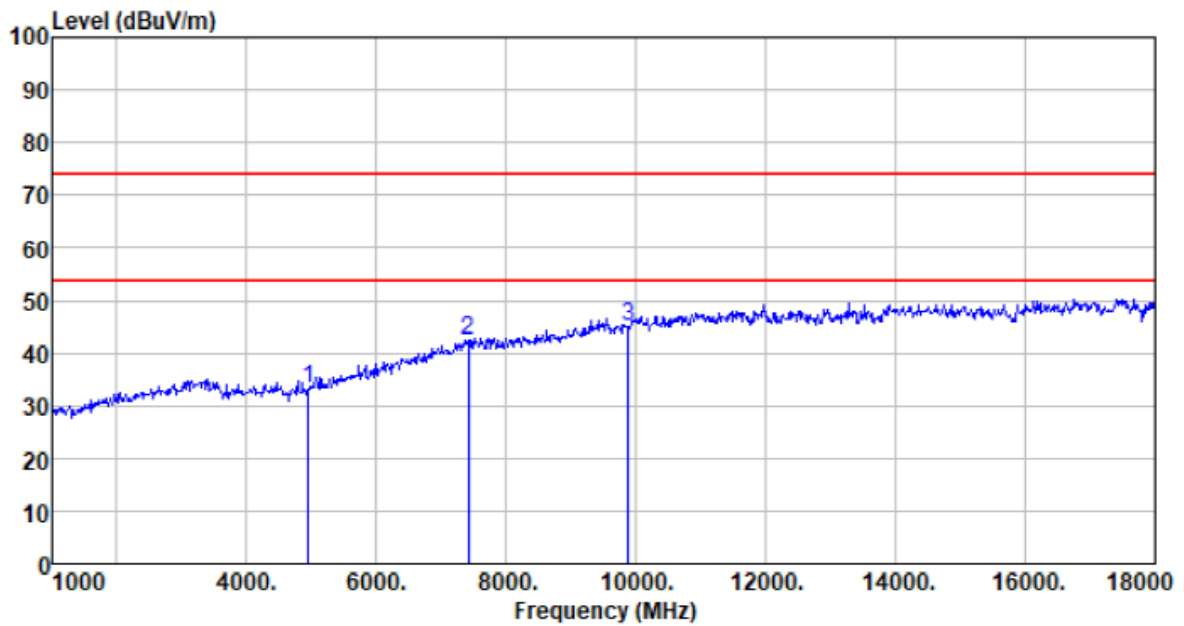

Freq MHz	Reading level dBuV	Antenna factor dB/m	Cable loss dB	Preamp factor dB	level dBuV/m	Limit level dBuV/m	Over limit dB	Remark
4944.000	35.23	31.44	4.77	38.39	33.05	74.00	-40.95	Peak
7416.000	38.51	36.33	6.73	39.02	42.55	74.00	-31.45	Peak
9888.000	38.45	38.19	8.08	39.77	44.95	74.00	-29.05	Peak

Remark:

1. Final Level = Receiver Read level + Antenna Factor + Cable Loss – Preamplifier Factor
2. “*”, means this data is the too weak instrument of signal is unable to test.
3. The emission levels of other frequencies are very lower than the limit and not show in test report.
4. For above 18GHz, no emission found.

Unwanted Emissions in Non-restricted Frequency Bands

Test channel:	Lowest	Polarization:	Horizontal
---------------	--------	---------------	------------

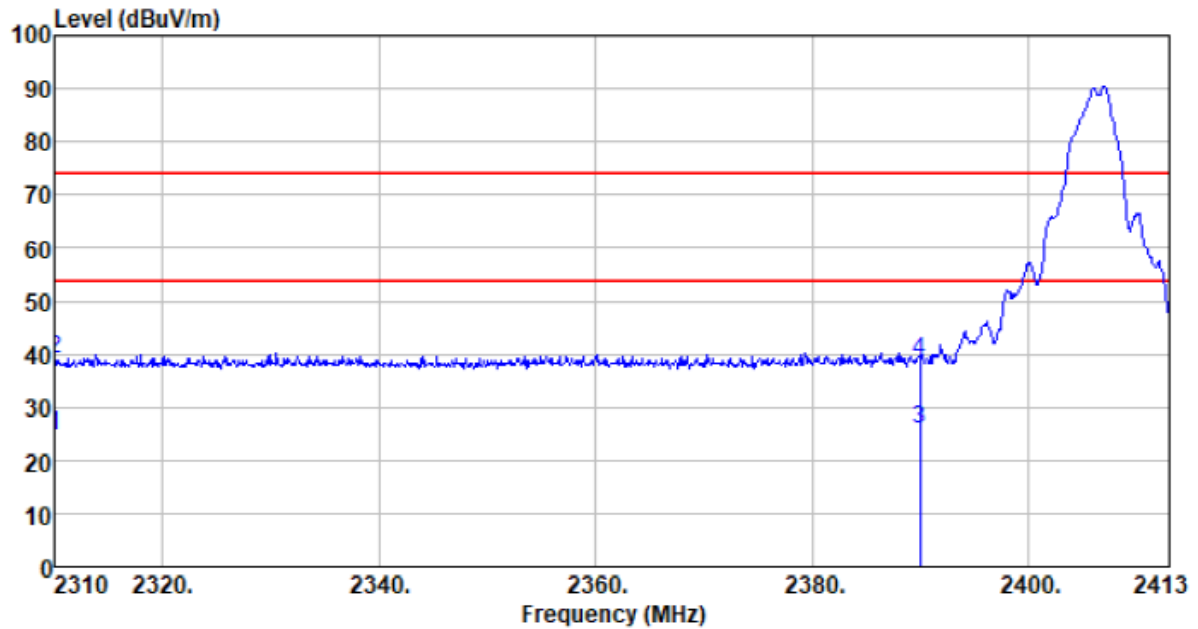

Freq MHz	Reading level dBuV	Antenna factor dB/m	Cable loss dB	Preamp factor dB	level dBuV/m	Limit level dBuV/m	Over limit dB	Remark
2310.000	33.39	27.17	2.81	38.52	24.85	54.00	-29.15	Average
2310.000	47.53	27.17	2.81	38.52	38.99	74.00	-35.01	Peak
2390.000	34.33	27.27	2.91	38.56	25.95	54.00	-28.05	Average
2390.000	47.25	27.27	2.91	38.56	38.87	74.00	-35.13	Peak

Test channel:	Lowest	Polarization:	Vertical
---------------	--------	---------------	----------

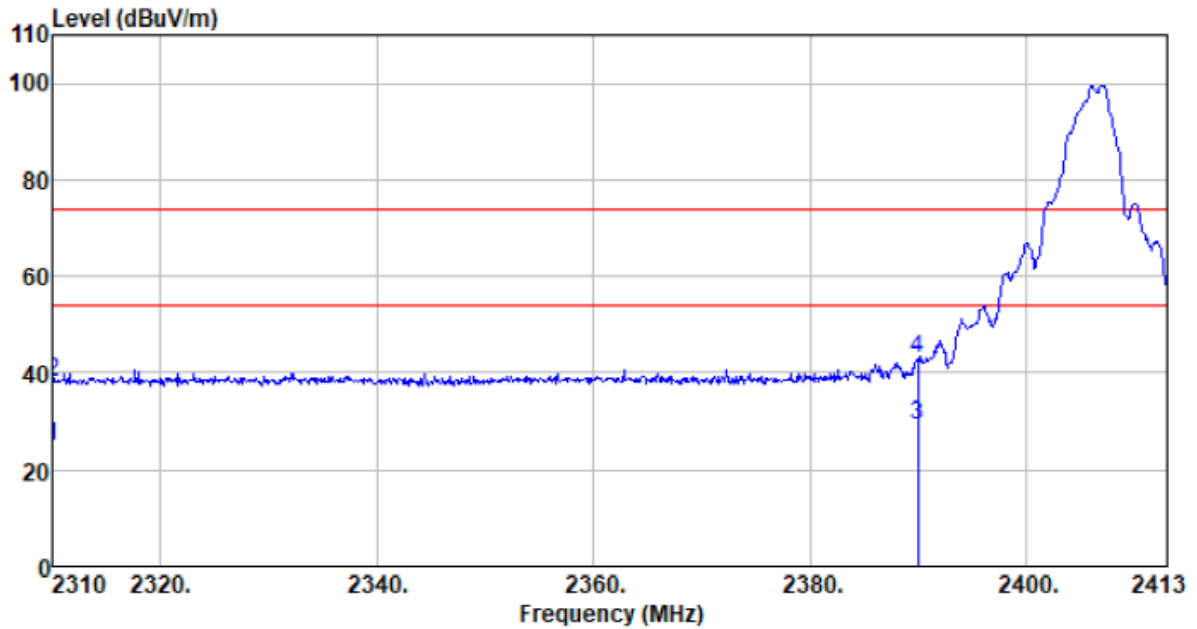

Freq MHz	Reading level dBuV	Antenna factor dB/m	Cable loss dB	Preamp factor dB	level dBuV/m	Limit level dBuV/m	Over limit dB	Remark
2310.000	33.43	27.17	2.81	38.52	24.89	54.00	-29.11	Average
2310.000	46.74	27.17	2.81	38.52	38.20	74.00	-35.80	Peak
2390.000	37.61	27.27	2.91	38.56	29.23	54.00	-24.77	Average
2390.000	51.46	27.27	2.91	38.56	43.08	74.00	-30.92	Peak

Test channel:	Highest	Polarization:	Horizontal
---------------	---------	---------------	------------

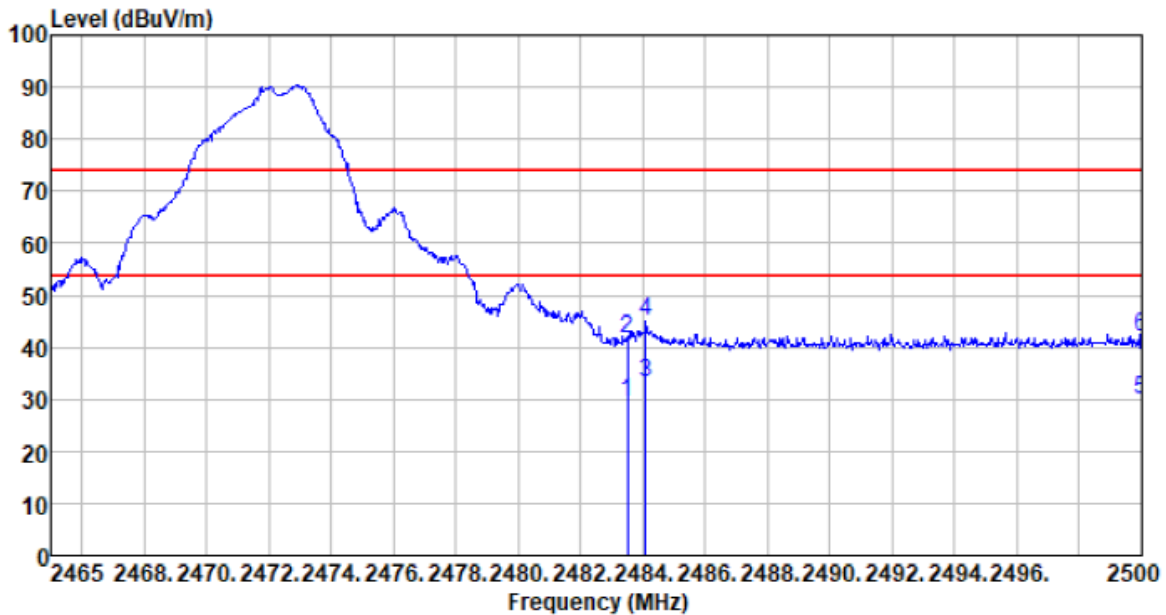

Freq MHz	Reading level dBuV	Antenna factor dB/m	Cable loss dB	Preamp factor dB	level dBuV/m	Limit level dBuV/m	Over limit dB	Remark
2483.500	37.74	27.38	2.99	38.59	29.52	54.00	-24.48	Average
2483.500	49.97	27.38	2.99	38.59	41.75	74.00	-32.25	Peak
2484.075	41.38	27.38	2.99	38.59	33.16	54.00	-20.84	Average
2484.075	53.24	27.38	2.99	38.59	45.02	74.00	-28.98	Peak
2500.000	38.21	27.40	3.01	38.60	30.02	54.00	-23.98	Average
2500.000	50.39	27.40	3.01	38.60	42.20	74.00	-31.80	Peak

Test channel:	Highest	Polarization:	Vertical
---------------	---------	---------------	----------

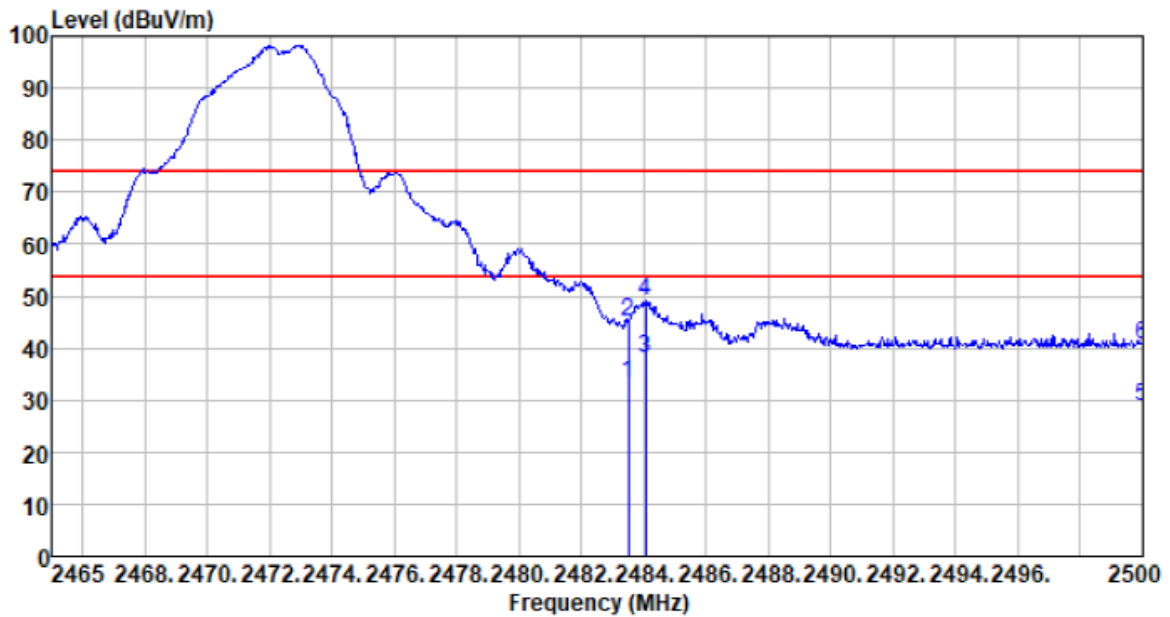

Freq MHz	Reading level dBuV	Antenna factor dB/m	Cable loss dB	Preamp factor dB	level dBuV/m	Limit level dBuV/m	Over limit dB	Remark
2483.500	41.29	27.38	2.99	38.59	33.07	54.00	-20.93	Average
2483.500	53.15	27.38	2.99	38.59	44.93	74.00	-29.07	Peak
2484.040	46.31	27.38	2.99	38.59	38.09	54.00	-15.91	Average
2484.040	57.17	27.38	2.99	38.59	48.95	74.00	-25.05	Peak
2500.000	36.80	27.40	3.01	38.60	28.61	54.00	-25.39	Average
2500.000	48.91	27.40	3.01	38.60	40.72	74.00	-33.28	Peak

Remarks:

1. Final Level = Receiver Read level + Antenna Factor + Cable Loss – Pre-amplifier Factor
2. The emission levels of other frequencies are very lower than the limit and not show in test report.

8 Test Setup Photo

Reference to the **appendix I** for details.

9 EUT Constructional Details

Reference to the **appendix II** for details.

---End---