

TEST REPORT

Applicant: ShenZhen FLYSKY Technology Co.,Ltd
Address of Applicant: 16F, Huafeng Building, No. 6006 Shennan Road, Futian District, Shenzhen, Guangdong, China
Manufacturer: ShenZhen FLYSKY Technology Co.,Ltd
Address of Manufacturer: 16F, Huafeng Building, No. 6006 Shennan Road, Futian District, Shenzhen, Guangdong, China
Factory: Dongguan Flysky RC Model technology Co.,Ltd
Address of Factory: West building 3, HuangjinyuanInd Park, Qiaoli North Gate, Changping Town, Dongguan, China

Equipment Under Test (EUT)

Product Name: 11-CHANNEL RECEIVER
Model No.: FS-R11P-BT-BS
Trade Mark: FLYSKY
FCC ID: 2A2UNR11P02
Applicable standards: FCC CFR Title 47 Part 15 Subpart C Section 15.247
Date of sample receipt: January 17, 2024
Date of Test: January 18, 2024-March 06, 2024
Date of report issued: March 06, 2024
Test Result : PASS *

* In the configuration tested, the EUT complied with the standards specified above.

Authorized Signature:



Robinson Luo
Laboratory Manager

2 Version

| Version No. | Date | Description |
|-------------|----------------|-------------|
| 00 | March 06, 2024 | Original |
| | | |
| | | |
| | | |
| | | |

Prepared By:

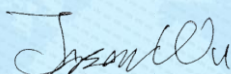

Date:

March 06, 2024

Project Engineer

Check By:

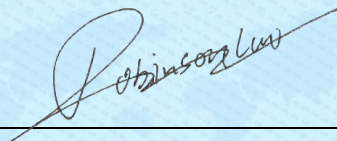

Date:

March 06, 2024

Reviewer

3 Contents

Page

| | | |
|-------|--|----|
| 1 | COVER PAGE | 1 |
| 2 | VERSION | 2 |
| 3 | CONTENTS | 3 |
| 4 | TEST SUMMARY | 4 |
| 4.1 | MEASUREMENT UNCERTAINTY | 4 |
| 5 | GENERAL INFORMATION | 5 |
| 5.1 | GENERAL DESCRIPTION OF EUT | 5 |
| 5.2 | TEST MODE | 7 |
| 5.3 | TEST FACILITY..... | 7 |
| 5.4 | TEST LOCATION | 7 |
| 5.5 | DESCRIPTION OF SUPPORT UNITS | 7 |
| 5.6 | DEVIATION FROM STANDARDS..... | 7 |
| 5.7 | ABNORMALITIES FROM STANDARD CONDITIONS..... | 7 |
| 5.8 | ADDITIONAL INSTRUCTIONS..... | 7 |
| 6 | TEST INSTRUMENTS LIST | 8 |
| 7 | TEST RESULTS AND MEASUREMENT DATA..... | 10 |
| 7.1 | ANTENNA REQUIREMENT..... | 10 |
| 7.2 | CONDUCTED EMISSIONS | 11 |
| 7.3 | CONDUCTED PEAK OUTPUT POWER | 14 |
| 7.4 | 20dB EMISSION BANDWIDTH | 15 |
| 7.5 | CARRIER FREQUENCIES SEPARATION..... | 16 |
| 7.6 | HOPPING CHANNEL NUMBER | 17 |
| 7.7 | DWELL TIME..... | 18 |
| 7.8 | SPURIOUS EMISSION IN NON-RESTRICTED & RESTRICTED BANDS | 19 |
| 7.8.1 | Conducted Emission Method..... | 19 |
| 7.8.2 | Radiated Emission Method..... | 20 |
| 8 | TEST SETUP PHOTO | 38 |
| 9 | EUT CONSTRUCTIONAL DETAILS | 38 |

4 Test Summary

| Test Item | Section | Result |
|----------------------------------|--------------------|--------|
| Antenna Requirement | 15.203/15.247 (c) | Pass |
| AC Power Line Conducted Emission | 15.207 | Pass |
| Conducted Peak Output Power | 15.247 (b)(1) | Pass |
| 20dB Occupied Bandwidth | 15.247 (a)(1) | Pass |
| Carrier Frequencies Separation | 15.247 (a)(1) | Pass |
| Hopping Channel Number | 15.247 (a)(1)(iii) | Pass |
| Dwell Time | 15.247 (a)(1)(iii) | Pass |
| Radiated Emission | 15.205/15.209 | Pass |
| Band Edge | 15.247(d) | Pass |

Pass: The EUT complies with the essential requirements in the standard.

Remark: Test according to ANSI C63.10:2013 .

4.1 Measurement Uncertainty

| Test Item | Frequency Range | Measurement Uncertainty | Notes |
|----------------------------------|-----------------|-------------------------|-------|
| Radiated Emission | 9kHz-30MHz | 3.1dB | (1) |
| Radiated Emission | 30MHz-200MHz | 3.8039dB | (1) |
| Radiated Emission | 200MHz-1GHz | 3.9679dB | (1) |
| Radiated Emission | 1GHz-18GHz | 4.29dB | (1) |
| Radiated Emission | 18GHz-40GHz | 3.30dB | (1) |
| AC Power Line Conducted Emission | 0.15MHz ~ 30MHz | 3.44dB | (1) |

Note (1): The measurement uncertainty is for coverage factor of k=2 and a level of confidence of 95%.

5 General Information

5.1 General Description of EUT

| | |
|------------------------|---------------------|
| Product Name: | 11-CHANNEL RECEIVER |
| Model No.: | FS-R11P-BT-BS |
| Serial No.: | 3K06423 |
| Test sample(s) ID: | GTS2024010234-1 |
| Sample(s) Status | Engineer sample |
| Operation Frequency: | 2408MHz~2475MHz |
| Channel numbers: | 135 |
| Modulation method: | FHSS |
| Modulation technology: | GFSK |
| Antenna Type: | Coaxial antenna |
| Antenna gain: | -1.11dBi |
| Power supply: | DC 3.5-8.4V |

Remark:

1. Antenna gain information provided by the customer
2. The relevant information of the sample is provided by the entrusting company, and the laboratory is not responsible for its authenticity.
3. The system works in the frequency range of 2408MHz to 2475MHz. This band has been divided to 135 independent channels. Each radio system uses 16 different channels; the minimum channel separation is ≥ 3.494 MHz. By using various switch-on times, hopping scheme and channel frequencies, the system can guarantee a jamming free radio transmission. Pre-testing all radio systems, this radio system recorded in the report is the worst mode. The channel list is below.

The test frequencies are below:

| Channel | Frequency |
|---------------------|-----------|
| The lowest channel | 2408MHz |
| The middle channel | 2440MHz |
| The Highest channel | 2475MHz |

| Operation Frequency each of channel | | | | | | | |
|-------------------------------------|-----------------|---------|-----------------|---------|-----------------|---------|-----------------|
| Channel | Frequency (MHz) | Channel | Frequency (MHz) | Channel | Frequency (MHz) | Channel | Frequency (MHz) |
| 1 | 2408 | 36 | 2425.5 | 71 | 2443 | 106 | 2460.5 |
| 2 | 2408.5 | 37 | 2426 | 72 | 2443.5 | 107 | 2461 |
| 3 | 2409 | 38 | 2426.5 | 73 | 2444 | 108 | 2461.5 |
| 4 | 2409.5 | 39 | 2427 | 74 | 2444.5 | 109 | 2462 |
| 5 | 2410 | 40 | 2427.5 | 75 | 2445 | 110 | 2462.5 |
| 6 | 2410.5 | 41 | 2428 | 76 | 2445.5 | 111 | 2463 |
| 7 | 2411 | 42 | 2428.5 | 77 | 2446 | 112 | 2463.5 |
| 8 | 2411.5 | 43 | 2429 | 78 | 2446.5 | 113 | 2464 |
| 9 | 2412 | 44 | 2429.5 | 79 | 2447 | 114 | 2464.5 |
| 10 | 2412.5 | 45 | 2430 | 80 | 2447.5 | 115 | 2465 |
| 11 | 2413 | 46 | 2430.5 | 81 | 2448 | 116 | 2465.5 |
| 12 | 2413.5 | 47 | 2431 | 82 | 2448.5 | 117 | 2466 |
| 13 | 2414 | 48 | 2431.5 | 83 | 2449 | 118 | 2466.5 |
| 14 | 2414.5 | 49 | 2432 | 84 | 2449.5 | 119 | 2467 |
| 15 | 2415 | 50 | 2432.5 | 85 | 2450 | 120 | 2467.5 |
| 16 | 2415.5 | 51 | 2433 | 86 | 2450.5 | 121 | 2468 |
| 17 | 2416 | 52 | 2433.5 | 87 | 2451 | 122 | 2468.5 |
| 18 | 2416.5 | 53 | 2434 | 88 | 2451.5 | 123 | 2469 |
| 19 | 2417 | 54 | 2434.5 | 89 | 2452 | 124 | 2469.5 |
| 20 | 2417.5 | 55 | 2435 | 90 | 2452.5 | 125 | 2470 |
| 21 | 2418 | 56 | 2435.5 | 91 | 2453 | 126 | 2470.5 |
| 22 | 2418.5 | 57 | 2436 | 92 | 2453.5 | 127 | 2471 |
| 23 | 2419 | 58 | 2436.5 | 93 | 2454 | 128 | 2471.5 |
| 24 | 2419.5 | 59 | 2437 | 94 | 2454.5 | 129 | 2472 |
| 25 | 2420 | 60 | 2437.5 | 95 | 2455 | 130 | 2472.5 |
| 26 | 2420.5 | 61 | 2438 | 96 | 2455.5 | 131 | 2473 |
| 27 | 2421 | 62 | 2438.5 | 97 | 2456 | 132 | 2473.5 |
| 28 | 2421.5 | 63 | 2439 | 98 | 2456.5 | 133 | 2474 |
| 29 | 2422 | 64 | 2439.5 | 99 | 2457 | 134 | 2474.5 |
| 30 | 2422.5 | 65 | 2440 | 100 | 2457.5 | 135 | 2475 |
| 31 | 2423 | 66 | 2440.5 | 101 | 2458 | | |
| 32 | 2423.5 | 67 | 2441 | 102 | 2458.5 | | |
| 33 | 2424 | 68 | 2441.5 | 103 | 2459 | | |
| 34 | 2424.5 | 69 | 2442 | 104 | 2459.5 | | |
| 35 | 2425 | 70 | 2442.5 | 105 | 2460 | | |

5.2 Test mode

| | |
|-------------------|------------------------------------|
| Transmitting mode | Keep the EUT in transmitting mode. |
|-------------------|------------------------------------|

5.3 Test Facility

| |
|--|
| <p>The test facility is recognized, certified, or accredited by the following organizations:</p> <ul style="list-style-type: none"> ● FCC —Registration No.: 381383 Designation Number: CN5029 Global United Technology Services Co., Ltd., Shenzhen EMC Laboratory has been registered and fully described in a report filed with the (FCC) Federal Communications Commission. The acceptance letter from the FCC is maintained in files. ● ISED—Registration No.: 9079A CAB identifier: CN0091 The 3m Semi-anechoic chamber of Global United Technology Services Co., Ltd. has been registered by Certification and Engineering Bureau of ISED for radio equipment testing. ● NVLAP (LAB CODE:600179-0) Global United Technology Services Co., Ltd., is accredited by the National Voluntary Laboratory Accreditation Program (NVLAP). |
|--|

5.4 Test Location

| |
|---|
| All other tests were performed at: |
| <p>Global United Technology Services Co., Ltd. Address: No. 123-128, Tower A, Jinyuan Business Building, No.2, Laodong Industrial Zone, Xixiang Road, Baoan District, Shenzhen, Guangdong, China 518102 Tel: 0755-27798480 Fax: 0755-27798960</p> |

5.5 Description of Support Units

| Manufacturer | Description | Model | Serial Number |
|------------------------------------|-----------------|-----------|---------------|
| ShenZhen FLYSKY Technology Co.,Ltd | Remote control | FS-MG11 | N/A |
| GW | DC POWER SUPPLY | GPR-6030D | EF924756 |

5.6 Deviation from Standards

| |
|-------|
| None. |
|-------|

5.7 Abnormalities from Standard Conditions

| |
|-------|
| None. |
|-------|

5.8 Additional Instructions

| |
|--|
| Software (Used for test) from client |
| Built-in by manufacturer, power set default. |

6 Test Instruments list

| Radiated Emission: | | | | | | |
|--------------------|-------------------------------------|--------------------------------|-----------------------|---------------|---------------------|-------------------------|
| Item | Test Equipment | Manufacturer | Model No. | Inventory No. | Cal.Date (mm-dd-yy) | Cal.Due date (mm-dd-yy) |
| 1 | 3m Semi- Anechoic Chamber | ZhongYu Electron | 9.2(L)*6.2(W)* 6.4(H) | GTS250 | June 23, 2021 | June 22, 2024 |
| 2 | Control Room | ZhongYu Electron | 6.2(L)*2.5(W)* 2.4(H) | GTS251 | N/A | N/A |
| 3 | EMI Test Receiver | Rohde & Schwarz | ESU26 | GTS203 | April 14, 2023 | April 13, 2024 |
| 4 | BiConiLog Antenna | SCHWARZBECK MESS-ELEKTRONIK | VULB9168 | GTS640 | March 19, 2023 | March 18, 2025 |
| 5 | Double -ridged waveguide horn | SCHWARZBECK MESS-ELEKTRONIK | BBHA 9120 D | GTS208 | April 17, 2023 | April 16, 2025 |
| 6 | EMI Test Software | AUDIX | E3 | N/A | N/A | N/A |
| 7 | Wideband Radio Communication Tester | Rohde & Schwarz | CMW500 | GTS575 | April 14, 2023 | April 13, 2024 |
| 8 | Loop Antenna | ZHINAN | ZN30900A | GTS534 | Nov. 13, 2023 | Nov.12, 2024 |
| 9 | Broadband Preamplifier | SCHWARZBECK | BBV9718 | GTS535 | April 14, 2023 | April 13, 2024 |
| 10 | Amplifier(1GHz-26.5GHz) | HP | 8449B | GTS601 | April 14, 2023 | April 13, 2024 |
| 11 | Horn Antenna (18-26.5GHz) | / | UG-598A/U | GTS664 | Oct. 29, 2023 | Oct. 28, 2024 |
| 12 | Horn Antenna (26.5-40GHz) | A.H Systems | SAS-573 | GTS665 | Oct. 29, 2023 | Oct. 28, 2024 |
| 13 | FSV·Signal Analyzer (10Hz-40GHz) | Keysight | FSV-40-N | GTS666 | March 13, 2023 | March 12, 2024 |
| 14 | Amplifier | / | LNA-1000-30S | GTS650 | April 14, 2023 | April 13, 2024 |
| 15 | CDNE M2+M3-16A | HCT | 30MHz-300MHz | GTS692 | Nov. 08, 2023 | Nov.07, 2024 |
| 16 | Wideband Amplifier | / | WDA-01004000-15P35 | GTS602 | April 14, 2023 | April 13, 2024 |
| 17 | Thermo meter | JINCHUANG | GSP-8A | GTS643 | April 19, 2023 | April 18, 2024 |
| 18 | RE cable 1 | GTS | N/A | GTS675 | July 31. 2023 | July 30. 2024 |
| 19 | RE cable 2 | GTS | N/A | GTS676 | July 31. 2023 | July 30. 2024 |
| 20 | RE cable 3 | GTS | N/A | GTS677 | July 31. 2023 | July 30. 2024 |
| 21 | RE cable 4 | GTS | N/A | GTS678 | July 31. 2023 | July 30. 2024 |
| 22 | RE cable 5 | GTS | N/A | GTS679 | July 31. 2023 | July 30. 2024 |
| 23 | RE cable 6 | GTS | N/A | GTS680 | July 31. 2023 | July 30. 2024 |
| 24 | RE cable 7 | GTS | N/A | GTS681 | July 31. 2023 | July 30. 2024 |
| 25 | RE cable 8 | GTS | N/A | GTS682 | July 31. 2023 | July 30. 2024 |

| Conducted Emission | | | | | | |
|--------------------|----------------------|-------------------------|----------------------|---------------|---------------------|-------------------------|
| Item | Test Equipment | Manufacturer | Model No. | Inventory No. | Cal.Date (mm-dd-yy) | Cal.Due date (mm-dd-yy) |
| 1 | Shielding Room | ZhongYu Electron | 7.3(L)x3.1(W)x2.9(H) | GTS252 | July 12, 2022 | July 11, 2027 |
| 2 | EMI Test Receiver | R&S | ESCI 7 | GTS552 | April 14, 2023 | April 13, 2024 |
| 3 | LISN | ROHDE & SCHWARZ | ENV216 | GTS226 | April 14, 2023 | April 13, 2024 |
| 4 | Coaxial Cable | GTS | N/A | GTS227 | N/A | N/A |
| 5 | EMI Test Software | AUDIX | E3 | N/A | N/A | N/A |
| 6 | Thermo meter | JINCHUANG | GSP-8A | GTS642 | April 19, 2023 | April 18, 2024 |
| 7 | Absorbing clamp | Elektronik-Feinmechanik | MDS21 | GTS229 | April 14, 2023 | April 13, 2024 |
| 8 | ISN | SCHWARZBECK | NTFM 8158 | GTS565 | April 14, 2023 | April 13, 2024 |
| 9 | High voltage probe | SCHWARZBECK | TK9420 | GTS537 | April 14, 2023 | April 13, 2024 |
| 10 | Antenna end assembly | Weinschel | 1870A | GTS560 | April 14, 2023 | April 13, 2024 |

| RF Conducted Test: | | | | | | |
|--------------------|--|--------------|------------------|------------|---------------------|-------------------------|
| Item | Test Equipment | Manufacturer | Model No. | Serial No. | Cal.Date (mm-dd-yy) | Cal.Due date (mm-dd-yy) |
| 1 | MXA Signal Analyzer | Agilent | N9020A | GTS566 | April 14, 2023 | April 13, 2024 |
| 2 | EMI Test Receiver | R&S | ESCI 7 | GTS552 | April 14, 2023 | April 13, 2024 |
| 3 | PSA Series Spectrum Analyzer | Agilent | E4440A | GTS536 | April 14, 2023 | April 13, 2024 |
| 4 | MXG vector Signal Generator | Agilent | N5182A | GTS567 | April 14, 2023 | April 13, 2024 |
| 5 | ESG Analog Signal Generator | Agilent | E4428C | GTS568 | April 14, 2023 | April 13, 2024 |
| 6 | USB RF Power Sensor | DARE | RPR3006W | GTS569 | April 14, 2023 | April 13, 2024 |
| 7 | RF Switch Box | Shongyi | RFSW3003328 | GTS571 | April 14, 2023 | April 13, 2024 |
| 8 | Programmable Constant Temp & Humi Test Chamber | WEWON | WHTH-150L-40-880 | GTS572 | April 14, 2023 | April 13, 2024 |
| 9 | Thermo meter | JINCHUANG | GSP-8A | GTS641 | April 19, 2023 | April 18, 2024 |

| General used equipment: | | | | | | |
|-------------------------|----------------|--------------|-----------|---------------|---------------------|-------------------------|
| Item | Test Equipment | Manufacturer | Model No. | Inventory No. | Cal.Date (mm-dd-yy) | Cal.Due date (mm-dd-yy) |
| 1 | Barometer | KUMAO | SF132 | GTS647 | April 19, 2023 | April 18, 2024 |

7 Test results and Measurement Data

7.1 Antenna requirement

| | |
|--|-------------------------------------|
| Standard requirement: | FCC Part15 C Section 15.203 /247(c) |
| 15.203 requirement: An intentional radiator shall be designed to ensure that no antenna other than that furnished by the responsible party shall be used with the device. The use of a permanently attached antenna or of an antenna that uses a unique coupling to the intentional radiator, the manufacturer may design the unit so that a broken antenna can be replaced by the user, but the use of a standard antenna jack or electrical connector is prohibited. | |
| 15.247(c) (1)(i) requirement: (i) Systems operating in the 2400-2483.5 MHz band that is used exclusively for fixed. Point-to-point operations may employ transmitting antennas with directional gain greater than 6dBi provided the maximum conducted output power of the intentional radiator is reduced by 1 dB for every 3 dB that the directional gain of the antenna exceeds 6dBi. | |
| EUT Antenna: | |
| The antenna is coaxial antenna, reference to the appendix II for details. | |

7.2 Conducted Emissions

| | | | | | | |
|--|--|-------|--------------|-----|-----------|----------|
| Test Requirement: | FCC Part15 C Section 15.207 | | | | | |
| Test Method: | ANSI C63.10:2013 | | | | | |
| Test Frequency Range: | 150KHz to 30MHz | | | | | |
| Receiver setup: | RBW=9KHz, VBW=30KHz, Sweep time=auto | | | | | |
| Limit: | Frequency range (MHz) | | Limit (dBuV) | | | |
| | | | Quasi-peak | | Average | |
| | 0.15-0.5 | | 66 to 56* | | 56 to 46* | |
| | 0.5-5 | | 56 | | 46 | |
| 5-30 | | 60 | | 50 | | |
| * Decreases with the logarithm of the frequency. | | | | | | |
| Test setup: | <p><i>Remark</i> E.U.T: Equipment Under Test LISN: Line Impedance Stabilization Network Test table height=0.8m</p> | | | | | |
| Test procedure: | <ol style="list-style-type: none"> 1. The E.U.T and simulators are connected to the main power through a line impedance stabilization network (L.I.S.N.). This provides a 50ohm/50uH coupling impedance for the measuring equipment. 2. The peripheral devices are also connected to the main power through a LISN that provides a 50ohm/50uH coupling impedance with 50ohm termination. (Please refer to the block diagram of the test setup and photographs). 3. Both sides of A.C. line are checked for maximum conducted interference. In order to find the maximum emission, the relative positions of equipment and all of the interface cables must be changed according to ANSI C63.10:2013 on conducted measurement. | | | | | |
| Test Instruments: | Refer to section 6.0 for details | | | | | |
| Test mode: | Refer to section 5.2 for details | | | | | |
| Test environment: | Temp.: | 25 °C | Humid.: | 52% | Press.: | 1012mbar |
| Test voltage: | AC 120V, 60Hz | | | | | |
| Test results: | Pass | | | | | |

Measurement data:

Pre-scan all test modes, found worst case at 2408MHz, and so only show the test result of it

Line:

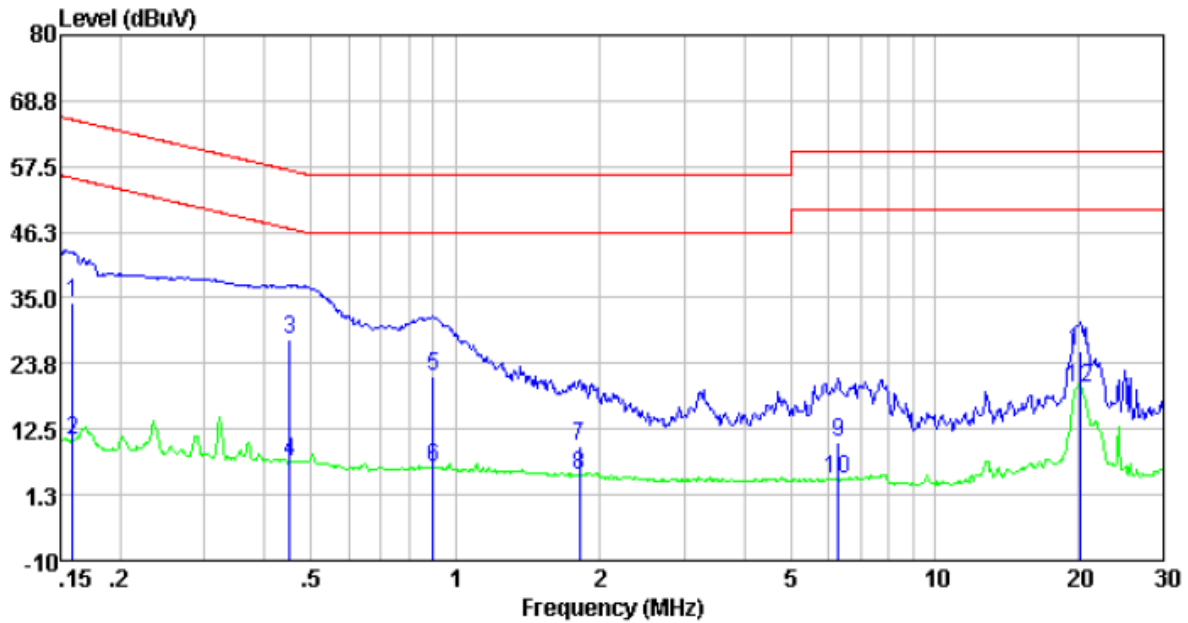

| Freq | Reading level | LISN/ISN factor | Cable loss | Level | Limit level | Over limit | Remark |
|-------|---------------|-----------------|------------|-------|-------------|------------|---------|
| MHz | dBuV | dB | dB | dBuV | dBuV | dB | |
| 0.16 | 24.71 | 9.55 | 0.01 | 34.27 | 65.52 | -31.25 | QP |
| 0.16 | 0.91 | 9.55 | 0.01 | 10.47 | 55.52 | -45.05 | Average |
| 0.45 | 18.26 | 9.49 | 0.01 | 27.76 | 56.85 | -29.09 | QP |
| 0.45 | -2.53 | 9.49 | 0.01 | 6.97 | 46.85 | -39.88 | Average |
| 0.90 | 12.19 | 9.49 | 0.03 | 21.71 | 56.00 | -34.29 | QP |
| 0.90 | -3.69 | 9.49 | 0.03 | 5.83 | 46.00 | -40.17 | Average |
| 1.82 | -0.20 | 9.59 | 0.04 | 9.43 | 56.00 | -46.57 | QP |
| 1.82 | -4.89 | 9.59 | 0.04 | 4.74 | 46.00 | -41.26 | Average |
| 6.29 | 0.87 | 9.37 | 0.08 | 10.32 | 60.00 | -49.68 | QP |
| 6.29 | -5.44 | 9.37 | 0.08 | 4.01 | 50.00 | -45.99 | Average |
| 20.16 | 15.69 | 10.00 | 0.19 | 25.88 | 60.00 | -34.12 | QP |
| 20.16 | 9.53 | 10.00 | 0.19 | 19.72 | 50.00 | -30.28 | Average |

Neutral:

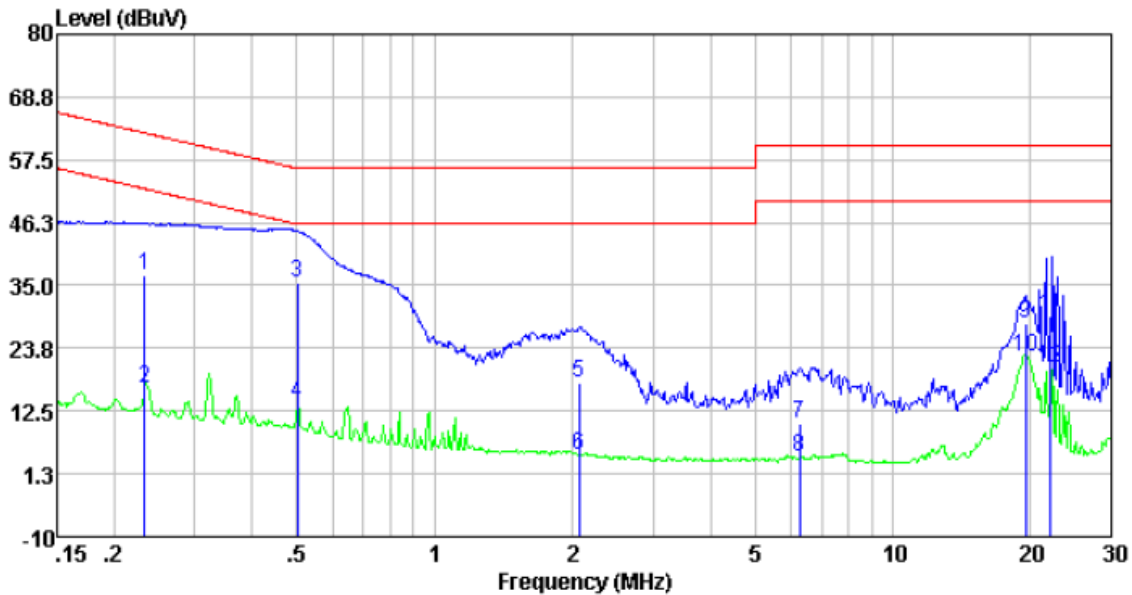

| Freq | Reading level | LISN/ISN factor | Cable loss | Level | Limit level | Over limit | Remark |
|-------|---------------|-----------------|------------|-------|-------------|------------|---------|
| MHz | dBuV | dB | dB | dBuV | dBuV | dB | |
| 0.23 | 27.36 | 9.56 | 0.01 | 36.93 | 62.35 | -25.42 | QP |
| 0.23 | 6.99 | 9.56 | 0.01 | 16.56 | 52.35 | -35.79 | Average |
| 0.50 | 26.00 | 9.57 | 0.01 | 35.58 | 56.00 | -20.42 | QP |
| 0.50 | 4.17 | 9.57 | 0.01 | 13.75 | 46.00 | -32.25 | Average |
| 2.07 | 7.90 | 9.55 | 0.04 | 17.49 | 56.00 | -38.51 | QP |
| 2.07 | -4.92 | 9.55 | 0.04 | 4.67 | 46.00 | -41.33 | Average |
| 6.25 | 0.70 | 9.54 | 0.08 | 10.32 | 60.00 | -49.68 | QP |
| 6.25 | -5.49 | 9.54 | 0.08 | 4.13 | 50.00 | -45.87 | Average |
| 19.53 | 17.86 | 10.06 | 0.18 | 28.10 | 60.00 | -31.90 | QP |
| 19.53 | 12.04 | 10.06 | 0.18 | 22.28 | 50.00 | -27.72 | Average |
| 22.09 | 19.12 | 10.17 | 0.19 | 29.48 | 60.00 | -30.52 | QP |
| 22.09 | 9.76 | 10.17 | 0.19 | 20.12 | 50.00 | -29.88 | Average |

Notes:

1. An initial pre-scan was performed on the line and neutral lines with peak detector.
2. Quasi-Peak and Average measurement were performed at the frequencies with maximized peak emission.
3. Final Level = Receiver Read level + LISN Factor + Cable Loss

7.3 Conducted Peak Output Power

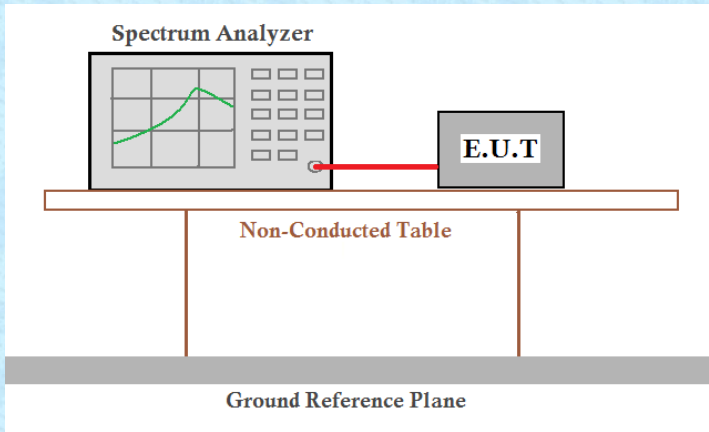
| | |
|-------------------|---|
| Test Requirement: | FCC Part15 C Section 15.247(a)(1) |
| Test Method: | ANSI C63.10:2013 |
| Limit: | 20.97dBm |
| Test setup: |  <p>The diagram illustrates the test setup. A Spectrum Analyzer is connected to an E.U.T. (Equipment Under Test) via a red cable. Both are placed on a Non-Conducted Table, which sits on a Ground Reference Plane.</p> |
| Test Instruments: | Refer to section 6.0 for details |
| Test mode: | Refer to section 5.2 for details |
| Test results: | Pass |

Measurement Data: The detailed test data see Appendix for 2.4G.

7.4 20dB Emission Bandwidth

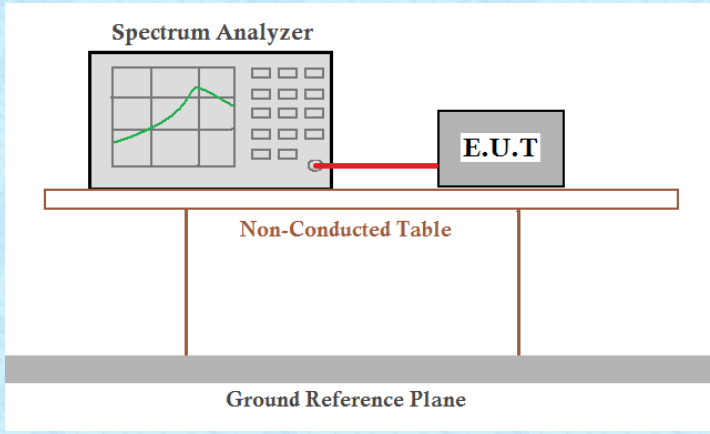
| | |
|-------------------|---|
| Test Requirement: | FCC Part15 C Section 15.247 (a)(1) |
| Test Method: | ANSI C63.10:2013 |
| Limit: | N/A |
| Test setup: |  <p>The diagram illustrates the test setup. A Spectrum Analyzer is connected to an E.U.T. (Equipment Under Test) via a red cable. Both are placed on a Non-Conducted Table, which is supported by a Ground Reference Plane.</p> |
| Test Instruments: | Refer to section 6.0 for details |
| Test mode: | Refer to section 5.2 for details |
| Test results: | Pass |

Measurement Data: The detailed test data see Appendix for 2.4G.

7.5 Carrier Frequencies Separation

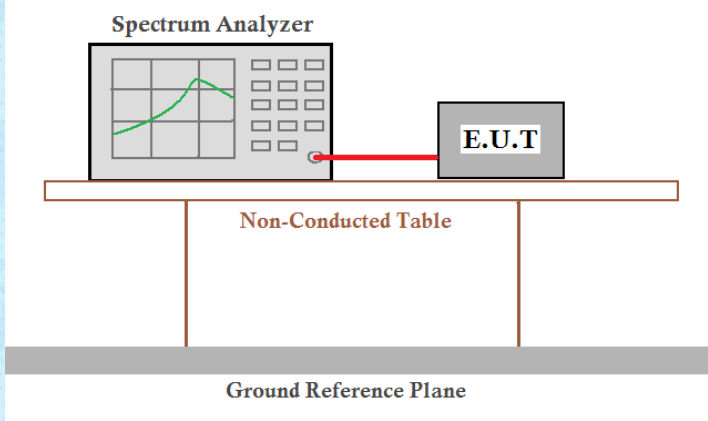
| | |
|-------------------|---|
| Test Requirement: | FCC Part15 C Section 15.247 (a)(1) |
| Test Method: | ANSI C63.10:2013 |
| Receiver setup: | RBW=300KHz, VBW=300KHz, detector=Peak |
| Limit: | 0.025MHz or 2/3 of the 20dB bandwidth (whichever is greater) |
| Test setup: |  <p>The diagram illustrates the test setup. A Spectrum Analyzer is connected to an E.U.T. (Equipment Under Test) via a red cable. Both are placed on a Non-Conducted Table, which is supported by a Ground Reference Plane.</p> |
| Test Instruments: | Refer to section 6.0 for details |
| Test mode: | Refer to section 5.2 for details |
| Test results: | Pass |

Measurement Data: The detailed test data see Appendix for 2.4G.

7.6 Hopping Channel Number

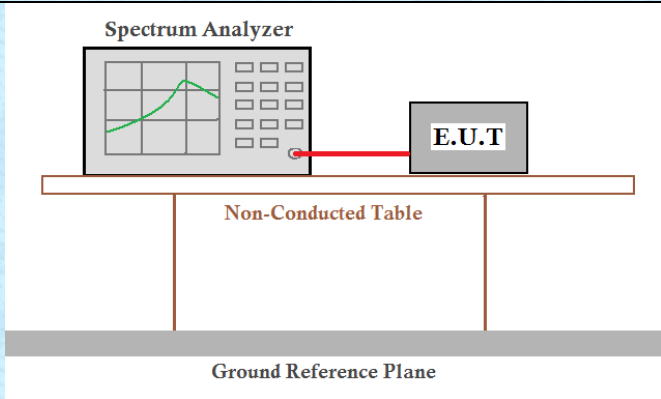
| | |
|-------------------|---|
| Test Requirement: | FCC Part15 C Section 15.247 (a)(1)(iii) |
| Test Method: | ANSI C63.10:2013 |
| Receiver setup: | RBW=300kHz, VBW=300kHz, Frequency range=2400MHz-2483.5MHz, Detector=Peak |
| Limit: | 15 channels |
| Test setup: |  <p>The diagram illustrates the test setup. A Spectrum Analyzer is connected to an E.U.T. (Equipment Under Test) via a red cable. Both are placed on a Non-Conducted Table, which sits on a Ground Reference Plane.</p> |
| Test Instruments: | Refer to section 6.0 for details |
| Test mode: | Refer to section 5.2 for details |
| Test results: | Pass |

Measurement Data: The detailed test data see Appendix for 2.4G.

7.7 Dwell Time

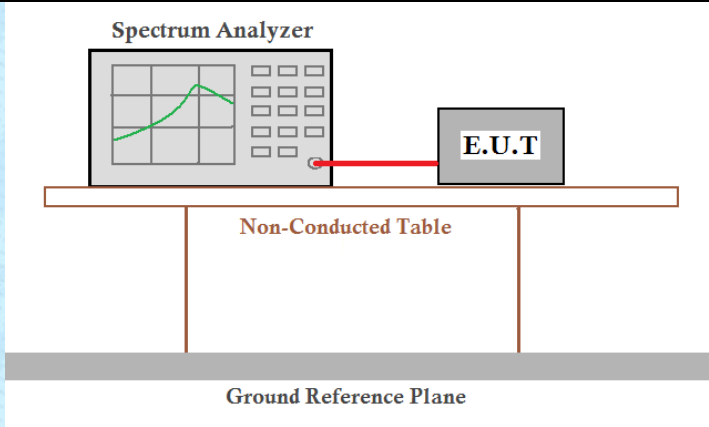
| | |
|-------------------|---|
| Test Requirement: | FCC Part15 C Section 15.247 (a)(1)(iii) |
| Test Method: | ANSI C63.10:2013 |
| Receiver setup: | RBW=300KHz, VBW=300KHz, Span=0Hz, Detector=Peak |
| Limit: | 0.4 Second |
| Test setup: |  <p>The diagram illustrates the test setup. A Spectrum Analyzer is connected to an E.U.T. (Equipment Under Test) via a red cable. Both are placed on a Non-Conducted Table, which is supported by a Ground Reference Plane.</p> |
| Test Instruments: | Refer to section 6.0 for details |
| Test mode: | Refer to section 5.2 for details |
| Test results: | Pass |

Measurement Data: The detailed test data see Appendix for 2.4G.

7.8 Spurious Emission in Non-restricted & restricted Bands

7.8.1 Conducted Emission Method

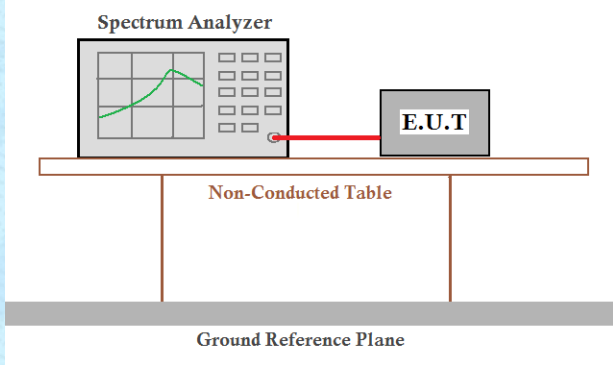
| | |
|-------------------|---|
| Test Requirement: | FCC Part15 C Section 15.247 (d) |
| Test Method: | ANSI C63.10:2013 |
| Receiver setup: | RBW=100kHz, VBW=300kHz, Detector=Peak |
| Limit: | In any 100 kHz bandwidth outside the frequency band in which the spread spectrum intentional radiator is operating, the radio frequency power that is produced by the intentional radiator shall be at least 20 dB below that in the 100 kHz bandwidth within the band that contains the highest level of the desired power, based on either an RF conducted or a radiated measurement. |
| Test setup: |  <p>The diagram illustrates the test setup. A Spectrum Analyzer is connected to an E.U.T. (Equipment Under Test) via a red cable. Both are placed on a Non-Conducted Table, which sits on a Ground Reference Plane.</p> |
| Test Instruments: | Refer to section6.0 for details |
| Test mode: | Refer to section 5.2 for details |
| Test results: | Pass |

Measurement Data: The detailed test data see Appendix for 2.4G.

7.8.2 Radiated Emission Method

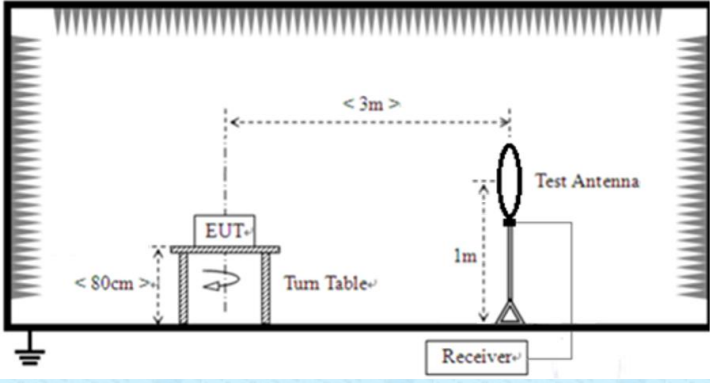
| | | | | | |
|--|--|--------------|---------|----------------------|------------|
| Test Requirement: | FCC Part15 C Section 15.209 and 15.205 | | | | |
| Test Method: | ANSI C63.10:2013 | | | | |
| Test Frequency Range: | 9kHz to 25GHz | | | | |
| Test site: | Measurement Distance: 3m | | | | |
| Receiver setup: | Frequency | Detector | RBW | VBW | Value |
| | 9KHz-150KHz | Quasi-peak | 200Hz | 600Hz | Quasi-peak |
| | 150KHz-30MHz | Quasi-peak | 9KHz | 30KHz | Quasi-peak |
| | 30MHz-1GHz | Quasi-peak | 120KHz | 300KHz | Quasi-peak |
| | Above 1GHz | Peak | 1MHz | 3MHz | Peak |
| | | Peak | 1MHz | 10Hz | Average |
| Note: For Duty cycle $\geq 98\%$, average detector set as above For Duty cycle $< 98\%$, average detector set as below: $VBW \geq 1 / T$ | | | | | |
| Limit: (Spurious Emissions) | Frequency | Limit (uV/m) | Value | Measurement Distance | |
| | 0.009MHz-0.490MHz | 2400/F(KHz) | QP | 300m | |
| | 0.490MHz-1.705MHz | 24000/F(KHz) | QP | 30m | |
| | 1.705MHz-30MHz | 30 | QP | 30m | |
| | 30MHz-88MHz | 100 | QP | 3m | |
| | 88MHz-216MHz | 150 | QP | | |
| | 216MHz-960MHz | 200 | QP | | |
| | 960MHz-1GHz | 500 | QP | | |
| | Above 1GHz | 500 | Average | | |
| | | 5000 | Peak | | |
| Test setup: | Below 30MHz | | | | |
| |  | | | | |
| Below 1GHz | | | | | |

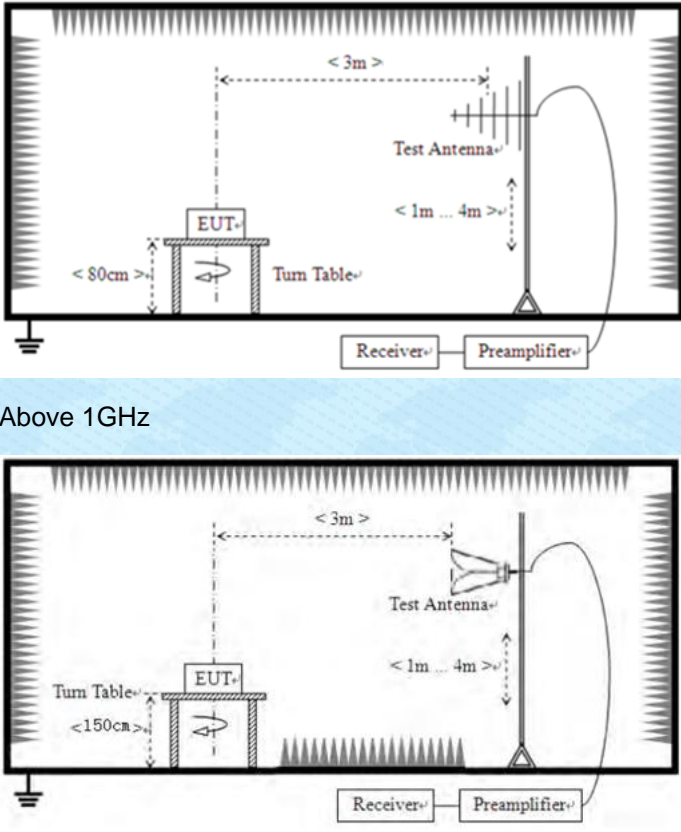
| | | | | | | | |
|--------------------------|---|---------|-------|---------|-----------|---------|-----------|
| |  <p>Above 1GHz</p> | | | | | | |
| <p>Test Procedure:</p> | <ol style="list-style-type: none"> 1. The EUT was placed on the top of a rotating table (0.8 meters for below 1GHz and 1.5meters for above 1GHz) above the ground at a 3 meter camber. The table was rotated 360 degrees to determine the position of the highest radiation. 2. The EUT was set 3 meters away from the interference-receiving antenna, which was mounted on the top of a variable-height antenna tower. 3. The antenna height is varied from one meter to four meters above the ground to determine the maximum value of the field strength. Both horizontal and vertical polarizations of the antenna are set to make the measurement. 4. For each suspected emission, the EUT was arranged to its worst case and then the antenna was tuned to heights from 1 meter to 4 meters and the rota table was turned from 0 degrees to 360 degrees to find the maximum reading. 5. The test-receiver system was set to Peak Detect Function and Specified Bandwidth with Maximum Hold Mode. 6. If the emission level of the EUT in peak mode was 10dB lower than the limit specified, then testing could be stopped and the peak values of the EUT would be reported. Otherwise the emissions that did not have 10dB margin would be re-tested one by one using peak, quasi-peak or average method as specified and then reported in a data sheet. | | | | | | |
| <p>Test Instruments:</p> | <p>Refer to section 5.8 for details</p> | | | | | | |
| <p>Test mode:</p> | <p>Refer to section 5.2 for details</p> | | | | | | |
| <p>Temp. / Hum.</p> | <table border="1"> <tr> <td>Temp.:</td> <td>25 °C</td> <td>Humid.:</td> <td>52%</td> <td>Press.:</td> <td>1 012mbar</td> </tr> </table> | Temp.: | 25 °C | Humid.: | 52% | Press.: | 1 012mbar |
| Temp.: | 25 °C | Humid.: | 52% | Press.: | 1 012mbar | | |

| | |
|---------------|------|
| Test results: | Pass |
|---------------|------|

Remark:

1. Pre-scan all kind of the place mode (X-axis, Y-axis, Z-axis), and found the Y-axis which it is worse case.

Measurement data:

■ **Below 30MHz**

The low frequency, which started from 9 kHz to 30 MHz, was pre-scanned and the result which was 20 dB lower than the limit line per 15.31(o) was not reported.

30MHz ~ 1GHz

| | | | |
|---------------|--------|---------------|------------|
| Test channel: | Lowest | Polarization: | Horizontal |
|---------------|--------|---------------|------------|

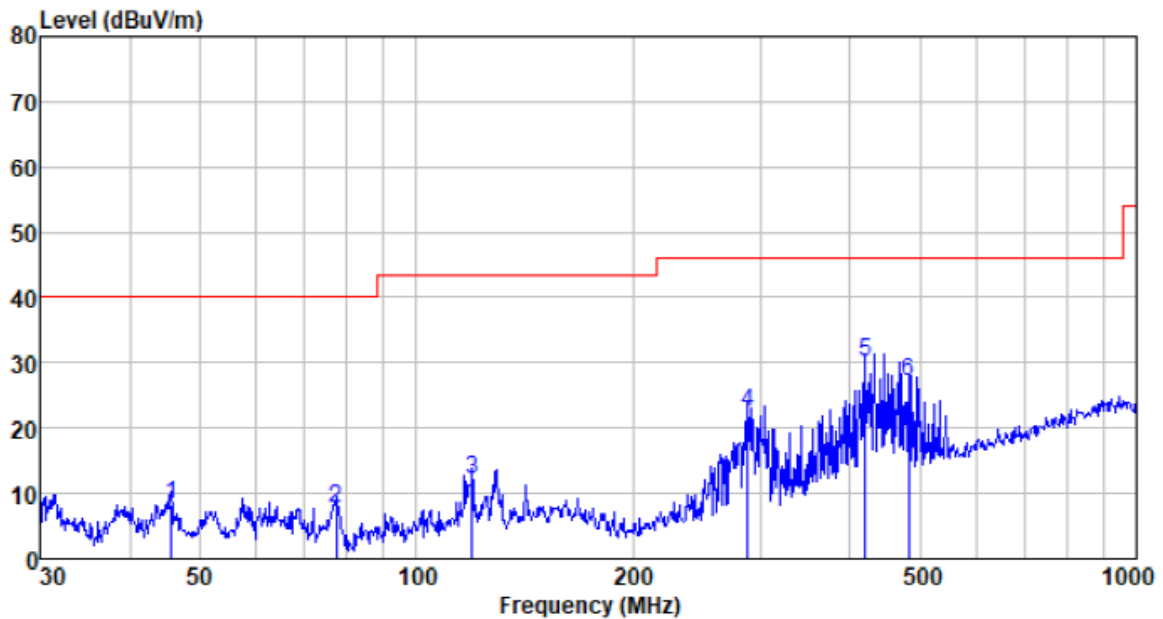

| Freq MHz | Reading level dBuV | Antenna factor dB/m | Cable loss dB | Preamp factor dB | level dBuV/m | Limit level dBuV/m | Over limit dB | Remark |
|-------------|--------------------------|---------------------------|---------------------|------------------------|-----------------|--------------------------|---------------------|--------|
| 45.695 | 27.96 | 13.32 | 0.73 | 33.70 | 8.31 | 40.00 | -31.69 | QP |
| 77.321 | 30.82 | 9.31 | 1.01 | 33.60 | 7.54 | 40.00 | -32.46 | QP |
| 119.436 | 32.90 | 11.16 | 1.36 | 33.40 | 12.02 | 43.50 | -31.48 | QP |
| 287.990 | 40.00 | 12.70 | 2.31 | 32.71 | 22.30 | 46.00 | -23.70 | QP |
| 420.580 | 43.21 | 16.13 | 2.95 | 32.24 | 30.05 | 46.00 | -15.95 | QP |
| 482.216 | 38.63 | 17.29 | 3.23 | 32.05 | 27.10 | 46.00 | -18.90 | QP |

| | | | |
|---------------|--------|---------------|----------|
| Test channel: | Lowest | Polarization: | Vertical |
|---------------|--------|---------------|----------|

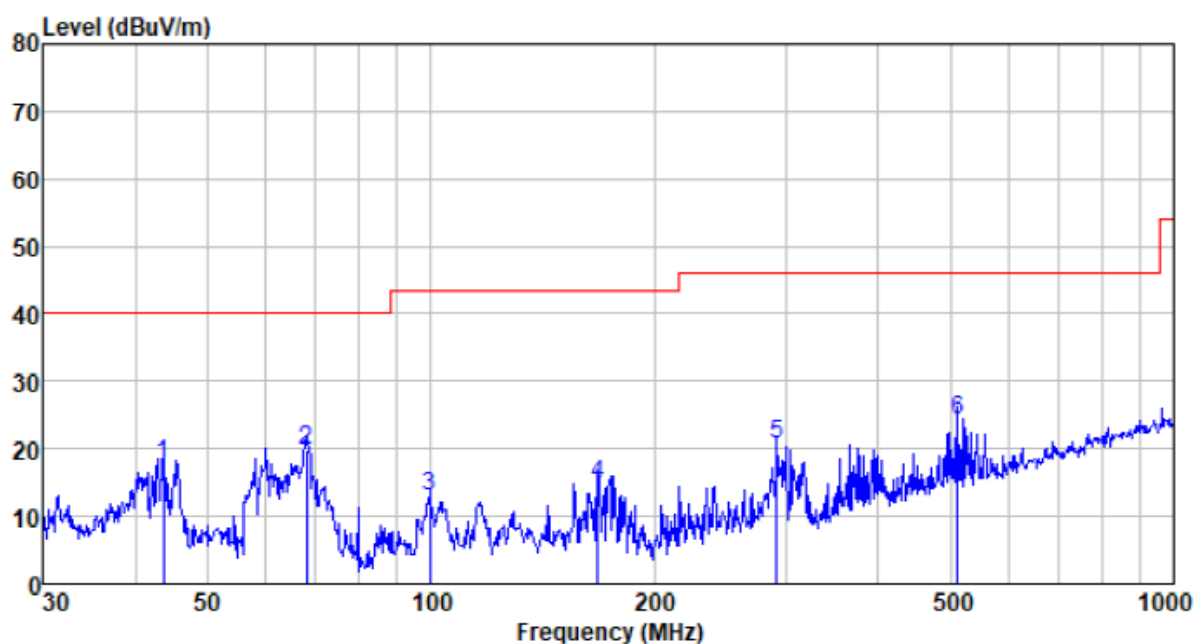

| Freq MHz | Reading level dBuV | Antenna factor dB/m | Cable loss dB | Preamp factor dB | level dBuV/m | Limit level dBuV/m | Over limit dB | Remark |
|-------------|--------------------------|---------------------------|---------------------|------------------------|-----------------|--------------------------|---------------------|--------|
| 43.659 | 37.37 | 13.38 | 0.70 | 33.71 | 17.74 | 40.00 | -22.26 | QP |
| 67.913 | 41.54 | 10.91 | 0.92 | 33.61 | 19.76 | 40.00 | -20.24 | QP |
| 99.528 | 35.69 | 9.65 | 1.19 | 33.60 | 12.93 | 43.50 | -30.57 | QP |
| 167.824 | 34.49 | 11.67 | 1.67 | 33.00 | 14.83 | 43.50 | -28.67 | QP |
| 292.058 | 38.50 | 12.59 | 2.32 | 32.71 | 20.70 | 46.00 | -25.30 | QP |
| 511.835 | 34.97 | 17.82 | 3.36 | 31.97 | 24.18 | 46.00 | -21.82 | QP |

| | | | |
|---------------|--------|---------------|------------|
| Test channel: | Middle | Polarization: | Horizontal |
|---------------|--------|---------------|------------|

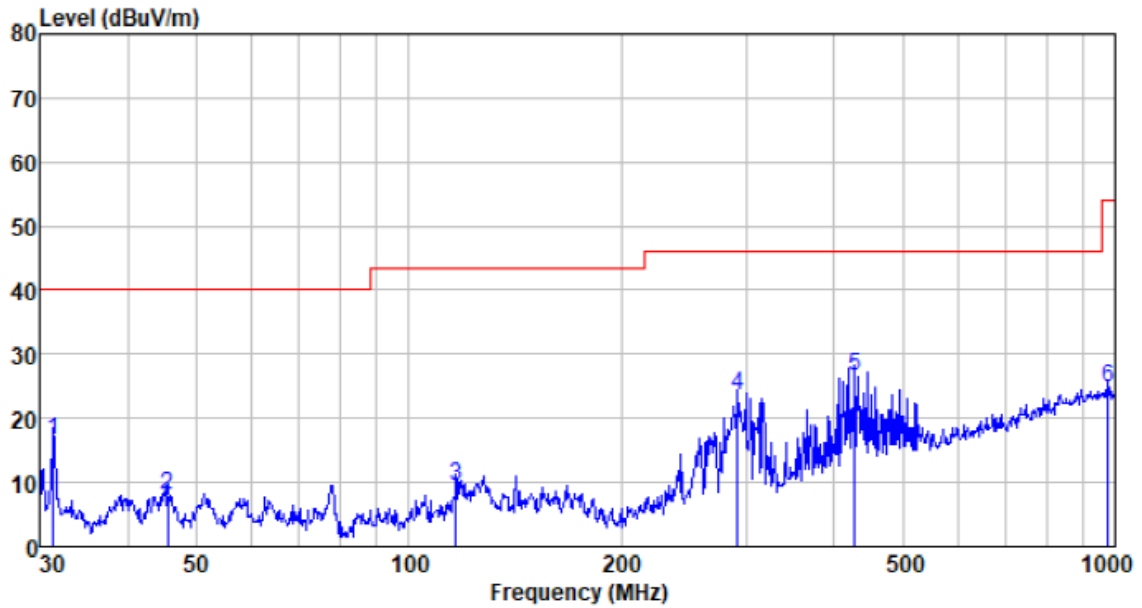

| Freq MHz | Reading level dBuV | Antenna factor dB/m | Cable loss dB | Preamp factor dB | level dBuV/m | Limit level dBuV/m | Over limit dB | Remark |
|-------------|--------------------------|---------------------------|---------------------|------------------------|-----------------|--------------------------|---------------------|--------|
| 31.399 | 37.53 | 12.28 | 0.57 | 33.79 | 16.59 | 40.00 | -23.41 | QP |
| 45.535 | 27.51 | 13.33 | 0.72 | 33.70 | 7.86 | 40.00 | -32.14 | QP |
| 116.540 | 30.49 | 10.96 | 1.33 | 33.42 | 9.36 | 43.50 | -34.14 | QP |
| 292.058 | 41.37 | 12.59 | 2.32 | 32.71 | 23.57 | 46.00 | -22.43 | QP |
| 428.019 | 39.39 | 16.28 | 2.99 | 32.21 | 26.45 | 46.00 | -19.55 | QP |
| 975.753 | 25.97 | 24.51 | 5.14 | 30.76 | 24.86 | 54.00 | -29.14 | QP |

| | | | |
|---------------|--------|---------------|----------|
| Test channel: | Middle | Polarization: | Vertical |
|---------------|--------|---------------|----------|

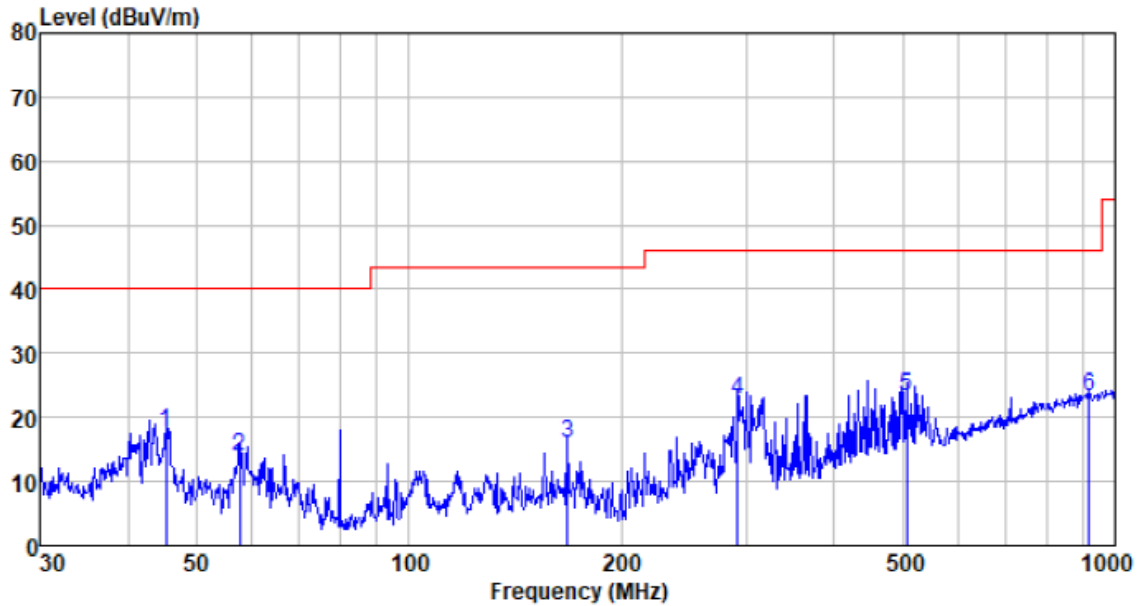

| Freq MHz | Reading level dBuV | Antenna factor dB/m | Cable loss dB | Preamp factor dB | level dBuV/m | Limit level dBuV/m | Over limit dB | Remark |
|-------------|--------------------------|---------------------------|---------------------|------------------------|-----------------|--------------------------|---------------------|--------|
| 45.217 | 37.28 | 13.34 | 0.72 | 33.70 | 17.64 | 40.00 | -22.36 | QP |
| 57.594 | 33.98 | 12.73 | 0.84 | 33.65 | 13.90 | 40.00 | -26.10 | QP |
| 167.824 | 35.72 | 11.67 | 1.67 | 33.00 | 16.06 | 43.50 | -27.44 | QP |
| 292.058 | 40.40 | 12.59 | 2.32 | 32.71 | 22.60 | 46.00 | -23.40 | QP |
| 506.479 | 34.21 | 17.72 | 3.33 | 31.98 | 23.28 | 46.00 | -22.72 | QP |
| 919.287 | 25.11 | 24.06 | 4.93 | 30.91 | 23.19 | 46.00 | -22.81 | QP |

| | | | |
|---------------|---------|---------------|------------|
| Test channel: | Highest | Polarization: | Horizontal |
|---------------|---------|---------------|------------|

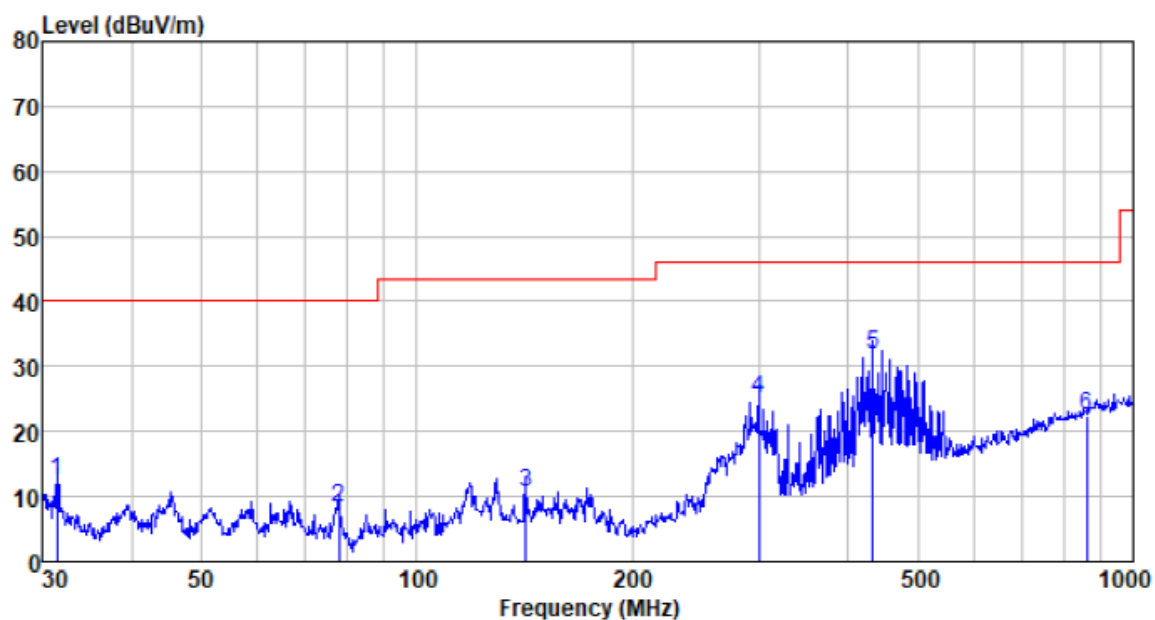

| Freq MHz | Reading level dBuV | Antenna factor dB/m | Cable loss dB | Preamp factor dB | level dBuV/m | Limit level dBuV/m | Over limit dB | Remark |
|-------------|--------------------------|---------------------------|---------------------|------------------------|-----------------|--------------------------|---------------------|--------|
| 31.510 | 33.39 | 12.29 | 0.57 | 33.79 | 12.46 | 40.00 | -27.54 | QP |
| 77.865 | 31.74 | 9.22 | 1.01 | 33.60 | 8.37 | 40.00 | -31.63 | QP |
| 141.826 | 29.94 | 12.42 | 1.52 | 33.20 | 10.68 | 43.50 | -32.82 | QP |
| 300.367 | 42.98 | 12.41 | 2.36 | 32.70 | 25.05 | 46.00 | -20.95 | QP |
| 432.546 | 44.69 | 16.37 | 3.01 | 32.20 | 31.87 | 46.00 | -14.13 | QP |
| 860.035 | 25.37 | 23.44 | 4.69 | 31.08 | 22.42 | 46.00 | -23.58 | QP |

| | | | |
|---------------|---------|---------------|----------|
| Test channel: | Highest | Polarization: | Vertical |
|---------------|---------|---------------|----------|

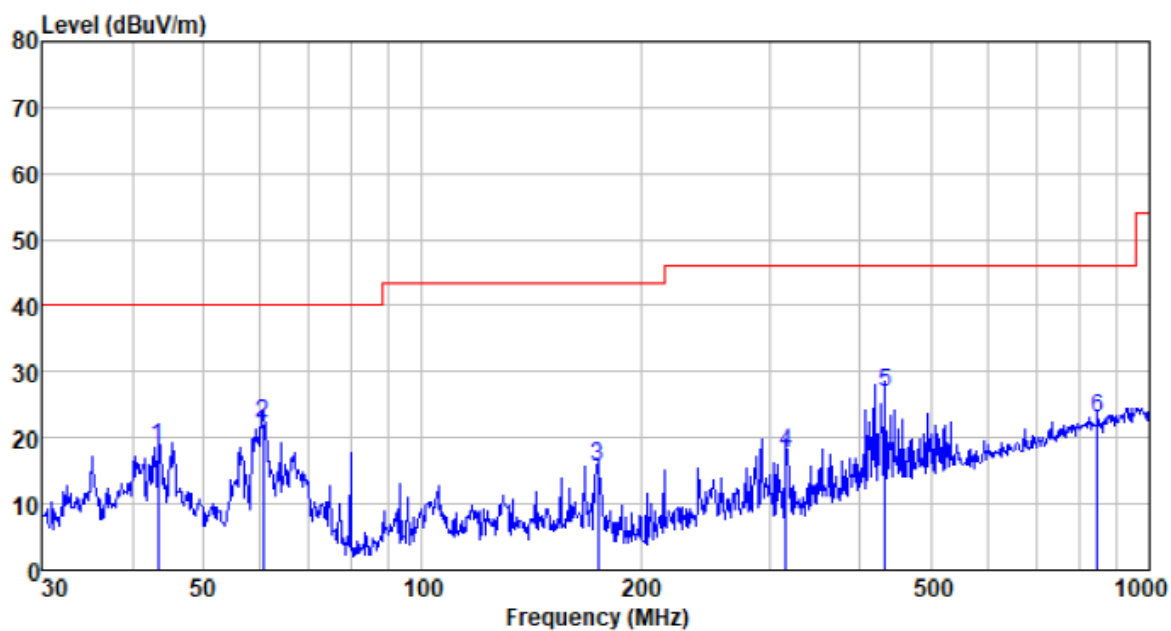

| Freq MHz | Reading level dBuV | Antenna factor dB/m | Cable loss dB | Preamp factor dB | level dBuV/m | Limit level dBuV/m | Over limit dB | Remark |
|-------------|--------------------------|---------------------------|---------------------|------------------------|-----------------|--------------------------|---------------------|--------|
| 43.353 | 38.19 | 13.39 | 0.70 | 33.71 | 18.57 | 40.00 | -21.43 | QP |
| 60.492 | 42.38 | 12.49 | 0.86 | 33.63 | 22.10 | 40.00 | -17.90 | QP |
| 174.424 | 36.11 | 10.91 | 1.71 | 32.96 | 15.77 | 43.50 | -27.73 | QP |
| 316.589 | 35.01 | 13.02 | 2.45 | 32.63 | 17.85 | 46.00 | -28.15 | QP |
| 432.546 | 39.54 | 16.37 | 3.01 | 32.20 | 26.72 | 46.00 | -19.28 | QP |
| 848.056 | 26.13 | 23.29 | 4.65 | 31.12 | 22.95 | 46.00 | -23.05 | QP |

- Above 1GHz
- Unwanted Emissions in Non-restricted Frequency Bands

| | | | |
|---------------|--------|---------------|------------|
| Test channel: | Lowest | Polarization: | Horizontal |
|---------------|--------|---------------|------------|

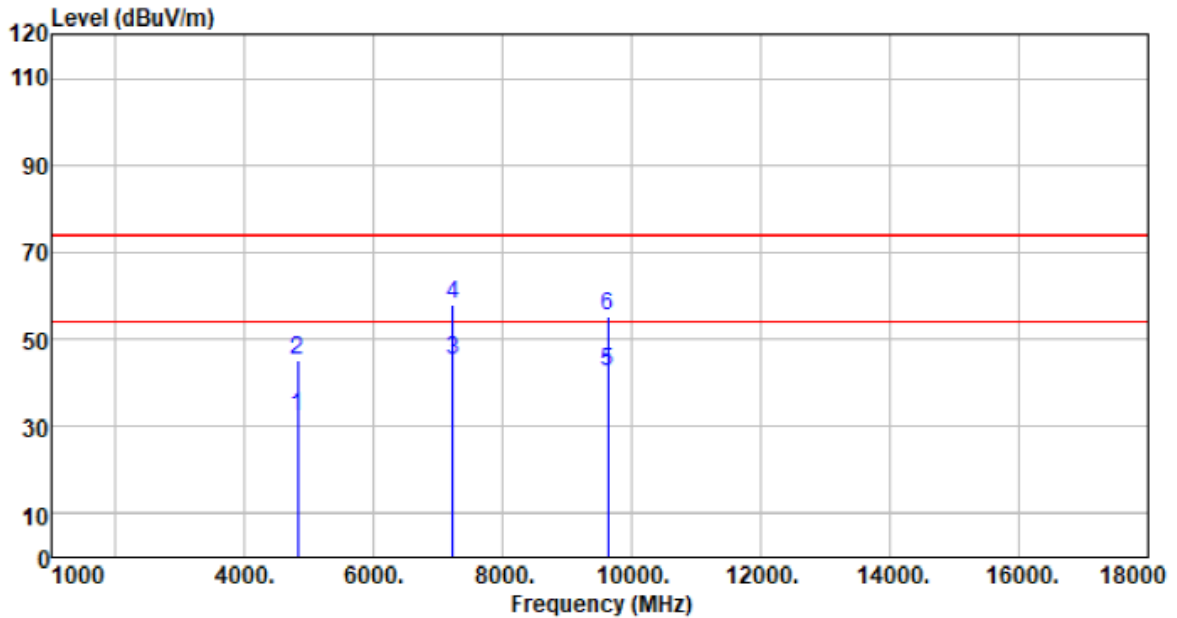

| Freq MHz | Reading level dBuV | Antenna factor dB/m | Cable loss dB | Preamp factor dB | level dBuV/m | Limit level dBuV/m | Over limit dB | Remark |
|-------------|--------------------------|---------------------------|---------------------|------------------------|-----------------|--------------------------|---------------------|---------|
| 4816.000 | 32.51 | 31.08 | 7.30 | 38.36 | 32.53 | 54.00 | -21.47 | Average |
| 4816.000 | 45.29 | 31.08 | 7.30 | 38.36 | 45.31 | 74.00 | -28.69 | Peak |
| 7224.000 | 38.73 | 35.95 | 9.44 | 38.97 | 45.15 | 54.00 | -8.85 | Average |
| 7224.000 | 51.51 | 35.95 | 9.44 | 38.97 | 57.93 | 74.00 | -16.07 | Peak |
| 9632.000 | 34.45 | 37.93 | 10.01 | 39.69 | 42.70 | 54.00 | -11.30 | Average |
| 9632.000 | 47.23 | 37.93 | 10.01 | 39.69 | 55.48 | 74.00 | -18.52 | Peak |

| | | | |
|---------------|--------|---------------|----------|
| Test channel: | Lowest | Polarization: | Vertical |
|---------------|--------|---------------|----------|

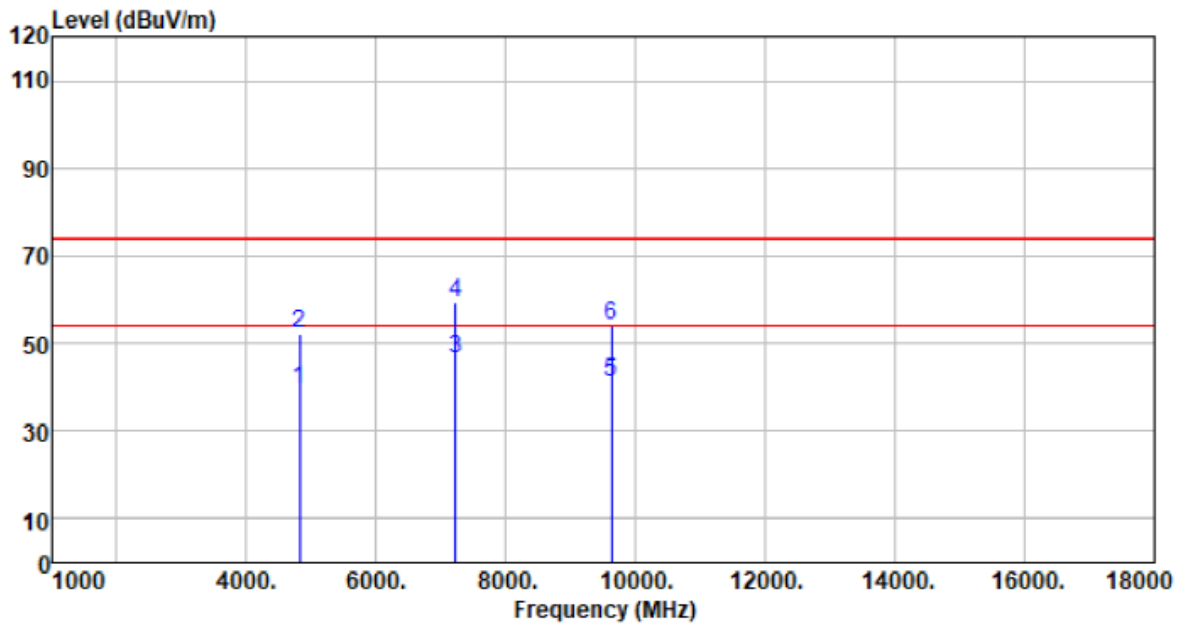

| Freq MHz | Reading level dBuV | Antenna factor dB/m | Cable loss dB | Preamp factor dB | level dBuV/m | Limit level dBuV/m | Over limit dB | Remark |
|-------------|--------------------------|---------------------------|---------------------|------------------------|-----------------|--------------------------|---------------------|---------|
| 4816.000 | 39.28 | 31.08 | 7.30 | 38.36 | 39.30 | 54.00 | -14.70 | Average |
| 4816.000 | 52.06 | 31.08 | 7.30 | 38.36 | 52.08 | 74.00 | -21.92 | Peak |
| 7224.000 | 39.99 | 35.95 | 9.44 | 38.97 | 46.41 | 54.00 | -7.59 | Average |
| 7224.000 | 52.77 | 35.95 | 9.44 | 38.97 | 59.19 | 74.00 | -14.81 | Peak |
| 9632.000 | 33.09 | 37.93 | 10.01 | 39.69 | 41.34 | 54.00 | -12.66 | Average |
| 9632.000 | 45.87 | 37.93 | 10.01 | 39.69 | 54.12 | 74.00 | -19.88 | Peak |

| | | | |
|---------------|--------|---------------|------------|
| Test channel: | Middle | Polarization: | Horizontal |
|---------------|--------|---------------|------------|

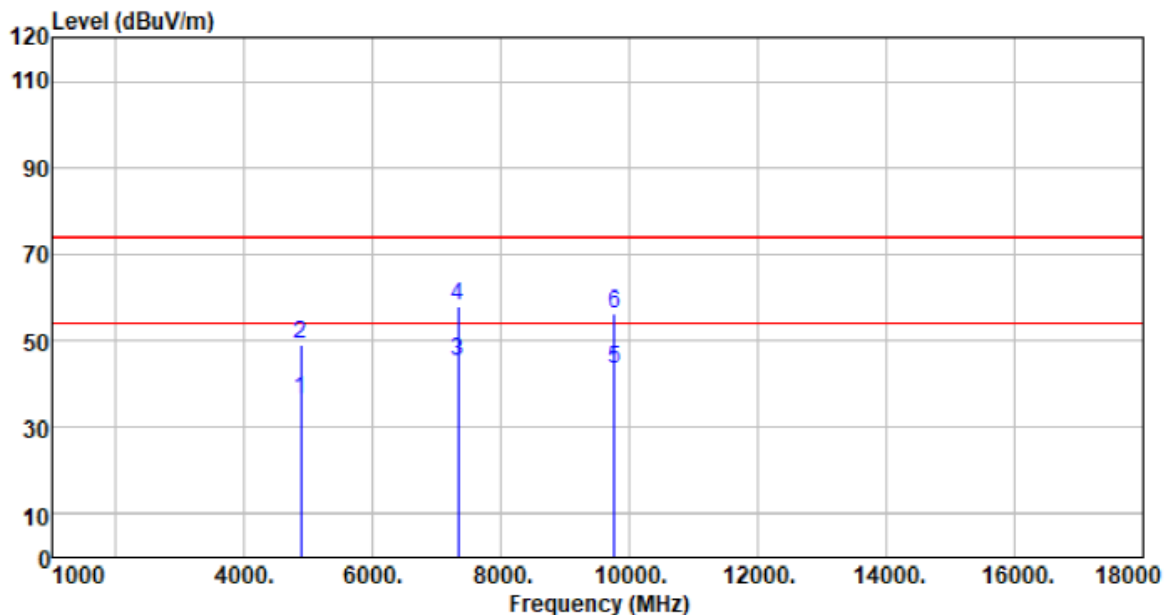

| Freq MHz | Reading level dBuV | Antenna factor dB/m | Cable loss dB | Preamp factor dB | level dBuV/m | Limit level dBuV/m | Over limit dB | Remark |
|-------------|--------------------------|---------------------------|---------------------|------------------------|-----------------|--------------------------|---------------------|---------|
| 4880.000 | 36.33 | 31.26 | 7.04 | 38.38 | 36.25 | 54.00 | -17.75 | Average |
| 4880.000 | 49.11 | 31.26 | 7.04 | 38.38 | 49.03 | 74.00 | -24.97 | Peak |
| 7320.000 | 38.98 | 36.14 | 9.18 | 39.00 | 45.30 | 54.00 | -8.70 | Average |
| 7320.000 | 51.76 | 36.14 | 9.18 | 39.00 | 58.08 | 74.00 | -15.92 | Peak |
| 9760.000 | 34.71 | 38.06 | 10.27 | 39.73 | 43.31 | 54.00 | -10.69 | Average |
| 9760.000 | 47.49 | 38.06 | 10.27 | 39.73 | 56.09 | 74.00 | -17.91 | Peak |

| | | | |
|---------------|--------|---------------|----------|
| Test channel: | Middle | Polarization: | Vertical |
|---------------|--------|---------------|----------|

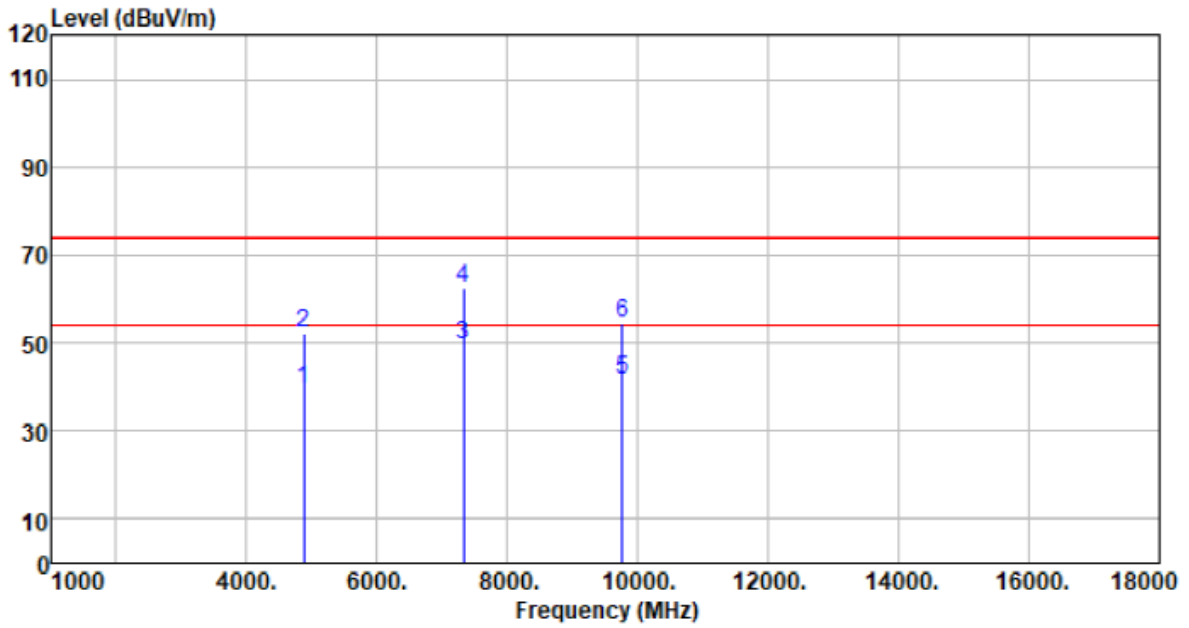

| Freq MHz | Reading level dBuV | Antenna factor dB/m | Cable loss dB | Preamp factor dB | level dBuV/m | Limit level dBuV/m | Over limit dB | Remark |
|-------------|--------------------------|---------------------------|---------------------|------------------------|-----------------|--------------------------|---------------------|---------|
| 4880.000 | 39.66 | 31.26 | 7.04 | 38.38 | 39.58 | 54.00 | -14.42 | Average |
| 4880.000 | 52.44 | 31.26 | 7.04 | 38.38 | 52.36 | 74.00 | -21.64 | Peak |
| 7320.000 | 43.49 | 36.14 | 9.18 | 39.00 | 49.81 | 54.00 | -4.19 | Average |
| 7320.000 | 56.27 | 36.14 | 9.18 | 39.00 | 62.59 | 74.00 | -11.41 | Peak |
| 9760.000 | 33.17 | 38.06 | 10.27 | 39.73 | 41.77 | 54.00 | -12.23 | Average |
| 9760.000 | 45.95 | 38.06 | 10.27 | 39.73 | 54.55 | 74.00 | -19.45 | Peak |

| | | | |
|---------------|---------|---------------|------------|
| Test channel: | Highest | Polarization: | Horizontal |
|---------------|---------|---------------|------------|

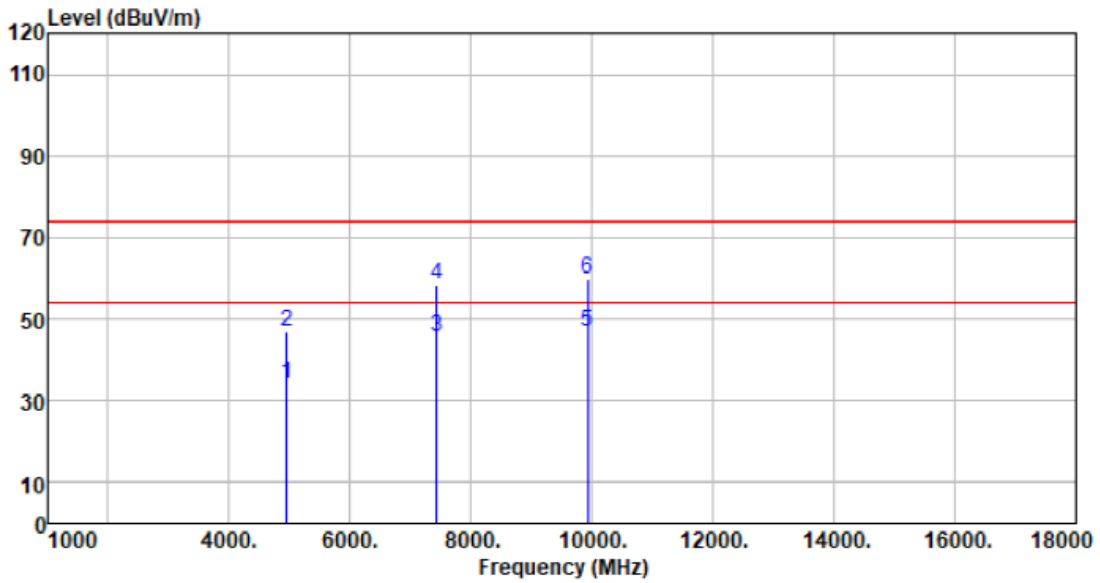

| Freq MHz | Reading level dBuV | Antenna factor dB/m | Cable loss dB | Preamp factor dB | level dBuV/m | Limit level dBuV/m | Over limit dB | Remark |
|-------------|--------------------------|---------------------------|---------------------|------------------------|-----------------|--------------------------|---------------------|---------|
| 4950.000 | 34.18 | 31.46 | 6.75 | 38.39 | 34.00 | 54.00 | -20.00 | Average |
| 4950.000 | 46.96 | 31.46 | 6.75 | 38.39 | 46.78 | 74.00 | -27.22 | Peak |
| 7425.000 | 39.24 | 36.35 | 9.00 | 39.03 | 45.56 | 54.00 | -8.44 | Average |
| 7425.000 | 52.02 | 36.35 | 9.00 | 39.03 | 58.34 | 74.00 | -15.66 | Peak |
| 9920.000 | 38.60 | 38.22 | 10.07 | 39.78 | 47.11 | 54.00 | -6.89 | Average |
| 9920.000 | 51.38 | 38.22 | 10.07 | 39.78 | 59.89 | 74.00 | -14.11 | Peak |

| | | | |
|---------------|---------|---------------|----------|
| Test channel: | Highest | Polarization: | Vertical |
|---------------|---------|---------------|----------|

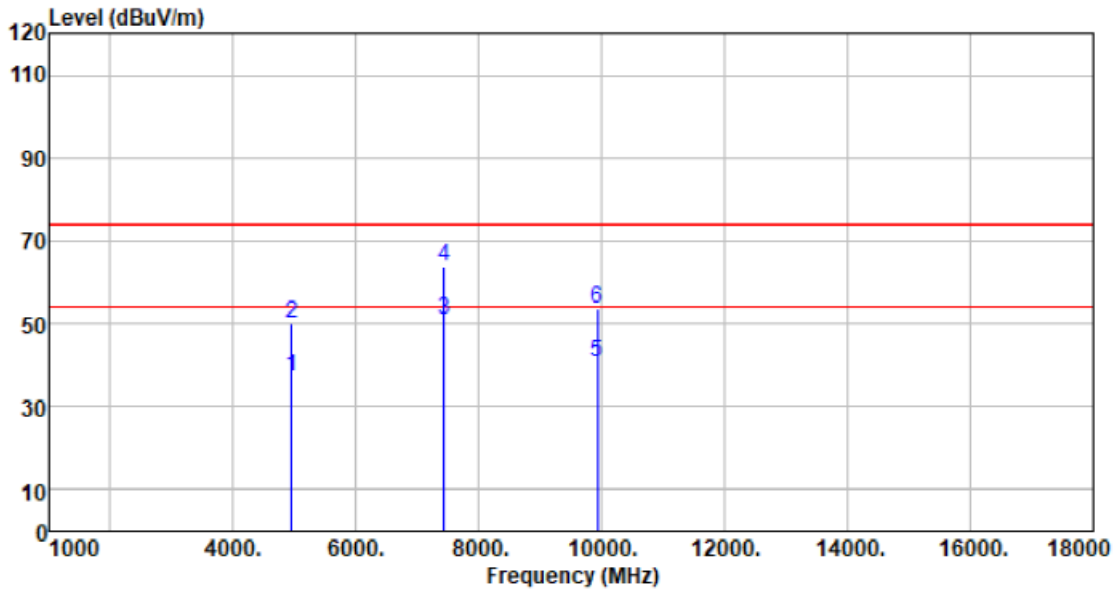

| Freq MHz | Reading level dBuV | Antenna factor dB/m | Cable loss dB | Preamp factor dB | level dBuV/m | Limit level dBuV/m | Over limit dB | Remark |
|-------------|--------------------------|---------------------------|---------------------|------------------------|-----------------|--------------------------|---------------------|---------|
| 4950.000 | 37.25 | 31.46 | 6.75 | 38.39 | 37.07 | 54.00 | -16.93 | Average |
| 4950.000 | 50.03 | 31.46 | 6.75 | 38.39 | 49.85 | 74.00 | -24.15 | Peak |
| 7425.000 | 44.45 | 36.35 | 9.00 | 39.03 | 50.77 | 54.00 | -3.23 | Average |
| 7425.000 | 57.23 | 36.35 | 9.00 | 39.03 | 63.55 | 74.00 | -10.45 | Peak |
| 9920.000 | 32.45 | 38.22 | 10.07 | 39.78 | 40.96 | 54.00 | -13.04 | Average |
| 9920.000 | 45.23 | 38.22 | 10.07 | 39.78 | 53.74 | 74.00 | -20.26 | Peak |

Remark:

1. Final Level = Receiver Read level + Antenna Factor + Cable Loss – Pre-amplifier Factor
2. The emission levels of other frequencies are very lower than the limit and not show in test report.
3. For above 18GHz, no emission found.

■ **Unwanted Emissions in Restricted Frequency Bands**

| | | | |
|---------------|--------|---------------|------------|
| Test channel: | Lowest | Polarization: | Horizontal |
|---------------|--------|---------------|------------|

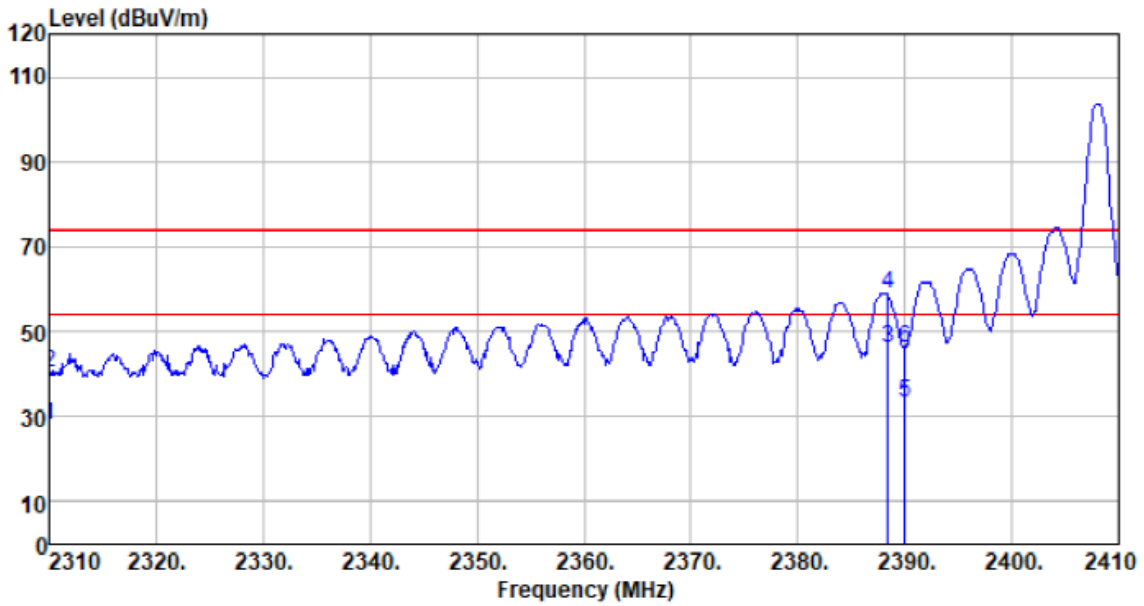

| Freq MHz | Reading level dBUV | Antenna factor dB/m | Cable loss dB | Preamp factor dB | level dBUV/m | Limit level dBUV/m | Over limit dB | Remark |
|-------------|--------------------------|---------------------------|---------------------|------------------------|-----------------|--------------------------|---------------------|---------|
| 2310.000 | 34.43 | 27.17 | 4.60 | 38.52 | 27.68 | 54.00 | -26.32 | Average |
| 2310.000 | 47.21 | 27.17 | 4.60 | 38.52 | 40.46 | 74.00 | -33.54 | Peak |
| 2388.400 | 52.86 | 27.27 | 4.65 | 38.56 | 46.22 | 54.00 | -7.78 | Average |
| 2388.400 | 65.64 | 27.27 | 4.65 | 38.56 | 59.00 | 74.00 | -15.00 | Peak |
| 2390.000 | 39.69 | 27.27 | 4.65 | 38.56 | 33.05 | 54.00 | -20.95 | Average |
| 2390.000 | 52.47 | 27.27 | 4.65 | 38.56 | 45.83 | 74.00 | -28.17 | Peak |

| | | | |
|---------------|--------|---------------|----------|
| Test channel: | Lowest | Polarization: | Vertical |
|---------------|--------|---------------|----------|

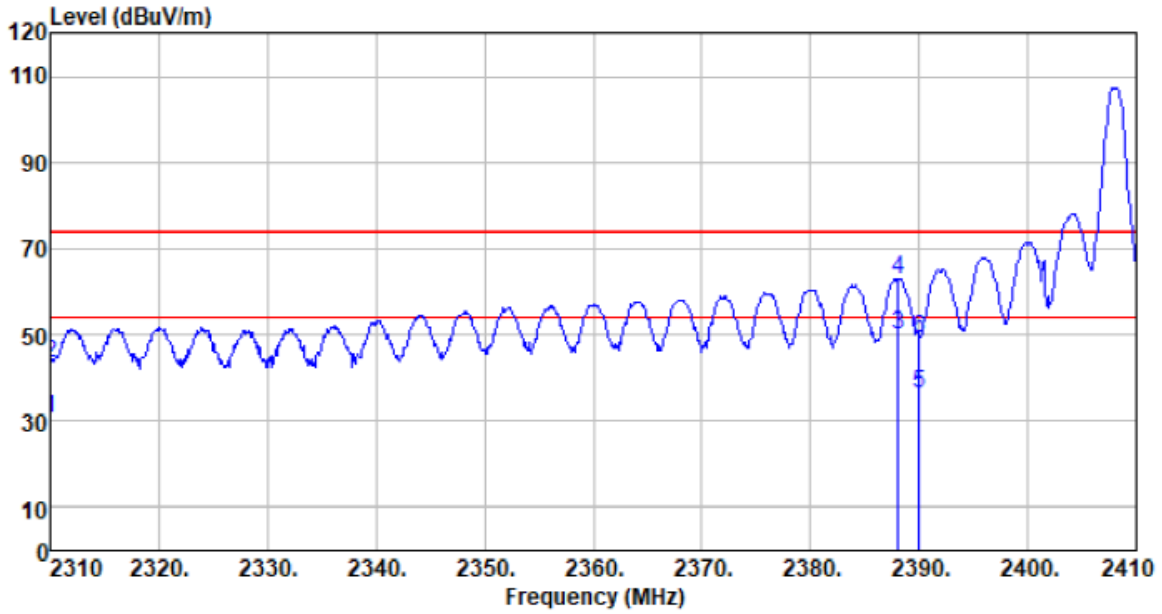

| Freq MHz | Reading level dBuV | Antenna factor dB/m | Cable loss dB | Preamp factor dB | level dBuV/m | Limit level dBuV/m | Over limit dB | Remark |
|-------------|--------------------------|---------------------------|---------------------|------------------------|-----------------|--------------------------|---------------------|---------|
| 2310.000 | 37.23 | 27.17 | 4.60 | 38.52 | 30.48 | 54.00 | -23.52 | Average |
| 2310.000 | 50.01 | 27.17 | 4.60 | 38.52 | 43.26 | 74.00 | -30.74 | Peak |
| 2388.100 | 56.77 | 27.27 | 4.65 | 38.56 | 50.13 | 54.00 | -3.87 | Average |
| 2388.100 | 69.55 | 27.27 | 4.65 | 38.56 | 62.91 | 74.00 | -11.09 | Peak |
| 2390.000 | 43.14 | 27.27 | 4.65 | 38.56 | 36.50 | 54.00 | -17.50 | Average |
| 2390.000 | 55.92 | 27.27 | 4.65 | 38.56 | 49.28 | 74.00 | -24.72 | Peak |

| | | | |
|---------------|---------|---------------|------------|
| Test channel: | Highest | Polarization: | Horizontal |
|---------------|---------|---------------|------------|

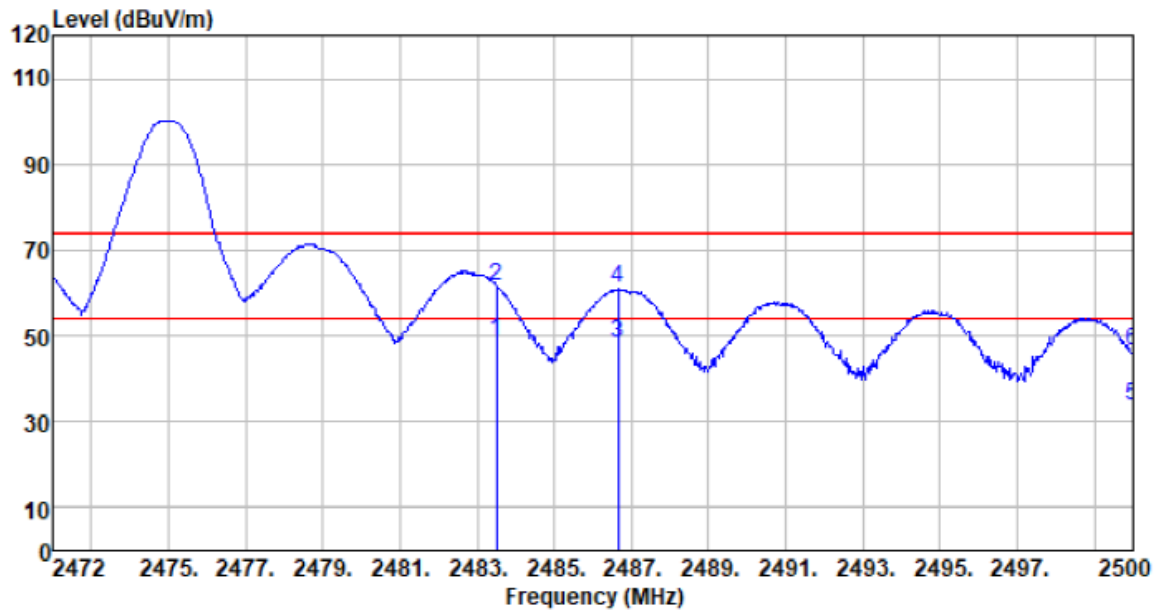

| Freq MHz | Reading level dBuV | Antenna factor dB/m | Cable loss dB | Preamp factor dB | level dBuV/m | Limit level dBuV/m | Over limit dB | Remark |
|-------------|--------------------------|---------------------------|---------------------|------------------------|-----------------|--------------------------|---------------------|---------|
| 2483.500 | 55.62 | 27.38 | 4.52 | 38.59 | 48.93 | 54.00 | -5.07 | Average |
| 2483.500 | 68.40 | 27.38 | 4.52 | 38.59 | 61.71 | 74.00 | -12.29 | Peak |
| 2486.644 | 54.92 | 27.38 | 4.52 | 38.59 | 48.23 | 54.00 | -5.77 | Average |
| 2486.644 | 67.70 | 27.38 | 4.52 | 38.59 | 61.01 | 74.00 | -12.99 | Peak |
| 2500.000 | 40.55 | 27.40 | 4.49 | 38.60 | 33.84 | 54.00 | -20.16 | Average |
| 2500.000 | 53.33 | 27.40 | 4.49 | 38.60 | 46.62 | 74.00 | -27.38 | Peak |

| | | | |
|---------------|---------|---------------|----------|
| Test channel: | Highest | Polarization: | Vertical |
|---------------|---------|---------------|----------|

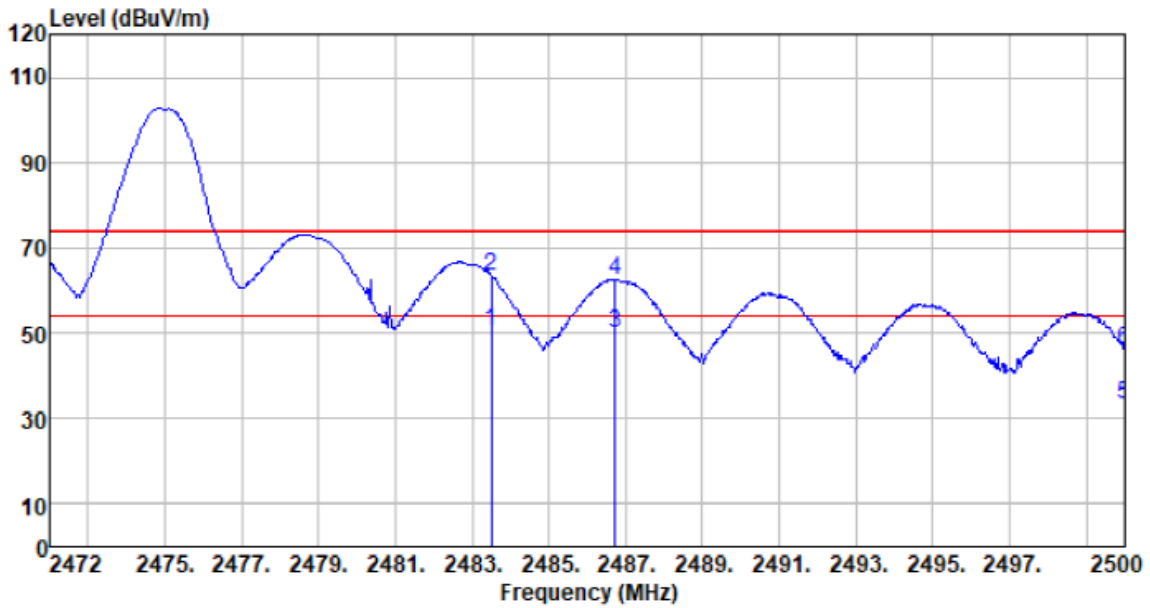

| Freq MHz | Reading level dBuV | Antenna factor dB/m | Cable loss dB | Preamp factor dB | level dBuV/m | Limit level dBuV/m | Over limit dB | Remark |
|-------------|--------------------------|---------------------------|---------------------|------------------------|-----------------|--------------------------|---------------------|---------|
| 2483.500 | 57.23 | 27.38 | 4.52 | 38.59 | 50.54 | 54.00 | -3.46 | Average |
| 2483.500 | 70.01 | 27.38 | 4.52 | 38.59 | 63.32 | 74.00 | -10.68 | Peak |
| 2486.728 | 56.51 | 27.38 | 4.52 | 38.59 | 49.82 | 54.00 | -4.18 | Average |
| 2486.728 | 69.29 | 27.38 | 4.52 | 38.59 | 62.60 | 74.00 | -11.40 | Peak |
| 2500.000 | 40.10 | 27.40 | 4.49 | 38.60 | 33.39 | 54.00 | -20.61 | Average |
| 2500.000 | 52.88 | 27.40 | 4.49 | 38.60 | 46.17 | 74.00 | -27.83 | Peak |

Remarks:

1. Final Level = Receiver Read level + Antenna Factor + Cable Loss – Pre-amplifier Factor
2. The emission levels of other frequencies are very lower than the limit and not show in test report.

8 Test Setup Photo

Reference to the **appendix I** for details.

9 EUT Constructional Details

Reference to the **appendix II** for details.

---End---