

TEST REPORT

Applicant: ShenZhen FLYSKY Technology Co.,Ltd

Address of Applicant: 16F, Huafeng Building, No. 6006 Shennan Road, Futian District, Shenzhen, Guangdong, China

Manufacturer: ShenZhen FLYSKY Technology Co.,Ltd

Address of Manufacturer: 16F, Huafeng Building, No. 6006 Shennan Road, Futian District, Shenzhen, Guangdong, China

Factory: Dongguan Flysky RC Model technology Co.,Ltd

Address of Factory: West building 3, HuangjinyuanInd Park, Qiaoli North Gate, Changping Town, Dongguan, China

Equipment Under Test (EUT)

Product Name: Digital Proportional Radio Control System

Model No.: FS-MG11-BT-BS, MG11

Trade Mark: FLYSKY

FCC ID: 2A2UNMG1100

Applicable standards: FCC CFR Title 47 Part 15 Subpart C Section 15.247

Date of sample receipt: January 17, 2024

Date of Test: January 18, 2024-March 21, 2024

Date of report issued: March 21, 2024

Test Result : PASS *

* In the configuration tested, the EUT complied with the standards specified above.

Authorized Signature:



Robinson Luo
Laboratory Manager

2 Version

Version No.	Date	Description
00	March 21, 2024	Original

Prepared By:

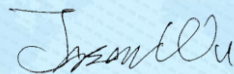

Date:

March 21, 2024

Project Engineer

Check By:

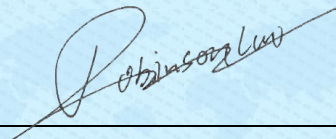

Date:

March 21, 2024

Reviewer

3 Contents

	Page
1 COVER PAGE	1
2 VERSION	2
3 CONTENTS	3
4 TEST SUMMARY	4
4.1 MEASUREMENT UNCERTAINTY	4
5 GENERAL INFORMATION	5
5.1 GENERAL DESCRIPTION OF EUT	5
5.2 TEST MODE	7
5.3 TEST FACILITY.....	7
5.4 TEST LOCATION	7
5.5 DESCRIPTION OF SUPPORT UNITS	7
5.6 DEVIATION FROM STANDARDS.....	7
5.7 ABNORMALITIES FROM STANDARD CONDITIONS.....	7
5.8 ADDITIONAL INSTRUCTIONS.....	7
6 TEST INSTRUMENTS LIST	8
7 TEST RESULTS AND MEASUREMENT DATA.....	10
7.1 ANTENNA REQUIREMENT.....	10
7.2 CONDUCTED PEAK OUTPUT POWER	11
7.3 20dB EMISSION BANDWIDTH	12
7.4 CARRIER FREQUENCIES SEPARATION.....	13
7.5 HOPPING CHANNEL NUMBER	14
7.6 DWELL TIME.....	15
7.7 SPURIOUS EMISSION IN NON-RESTRICTED & RESTRICTED BANDS	16
7.7.1 Conducted Emission Method.....	16
7.7.2 Radiated Emission Method.....	17
8 TEST SETUP PHOTO	35
9 EUT CONSTRUCTIONAL DETAILS	35

4 Test Summary

Test Item	Section	Result
Antenna Requirement	15.203/15.247 (c)	Pass
AC Power Line Conducted Emission	15.207	N/A
Conducted Peak Output Power	15.247 (b)(1)	Pass
20dB Occupied Bandwidth	15.247 (a)(1)	Pass
Carrier Frequencies Separation	15.247 (a)(1)	Pass
Hopping Channel Number	15.247 (a)(1)(iii)	Pass
Dwell Time	15.247 (a)(1)(iii)	Pass
Radiated Emission	15.205/15.209	Pass
Band Edge	15.247(d)	Pass

Pass: The EUT complies with the essential requirements in the standard.

Remark: Test according to ANSI C63.10:2013 .

4.1 Measurement Uncertainty

Test Item	Frequency Range	Measurement Uncertainty	Notes
Radiated Emission	9kHz-30MHz	3.1dB	(1)
Radiated Emission	30MHz-200MHz	3.8039dB	(1)
Radiated Emission	200MHz-1GHz	3.9679dB	(1)
Radiated Emission	1GHz-18GHz	4.29dB	(1)
Radiated Emission	18GHz-40GHz	3.30dB	(1)
AC Power Line Conducted Emission	0.15MHz ~ 30MHz	3.44dB	(1)

Note (1): The measurement uncertainty is for coverage factor of k=2 and a level of confidence of 95%.

5 General Information

5.1 General Description of EUT

Product Name:	Digital Proportional Radio Control System
Model No.:	FS-MG11-BT-BS, MG11
Test Model No:	FS-MG11-BT-BS
Remark: All above models are identical in the same PCB layout, interior structure and electrical circuits. The only difference is model name for commercial purpose.	
Serial No.:	3K06423
Test sample(s) ID:	GTS2024010233-1
Sample(s) Status	Engineer sample
Operation Frequency:	2408MHz~2475MHz
Channel numbers:	135
Modulation method:	FHSS
Modulation technology:	GFSK
Antenna Type:	PCB antenna
Antenna gain:	1dBi(declare by applicant)
Power supply:	DC 6V(4*1.5V Size"AA" battery)

Remark:

1. Antenna gain information provided by the customer
2. The relevant information of the sample is provided by the entrusting company, and the laboratory is not responsible for its authenticity.
3. The system works in the frequency range of 2408MHz to 2475MHz. This band has been divided to 135 independent channels. Each radio system uses 15 different channels; the minimum channel separation is ≥ 2 MHz. By using various switch-on times, hopping scheme and channel frequencies, the system can guarantee a jamming free radio transmission. Pre-testing all radio systems, this radio system recorded in the report is the worst mode. The channel list is below.

The test frequencies are below:

Channel	Frequency
The lowest channel	2408MHz
The middle channel	2440MHz
The Highest channel	2475MHz

Operation Frequency each of channel							
Channel	Frequency (MHz)	Channel	Frequency (MHz)	Channel	Frequency (MHz)	Channel	Frequency (MHz)
1	2408	36	2425.5	71	2443	106	2460.5
2	2408.5	37	2426	72	2443.5	107	2461
3	2409	38	2426.5	73	2444	108	2461.5
4	2409.5	39	2427	74	2444.5	109	2462
5	2410	40	2427.5	75	2445	110	2462.5
6	2410.5	41	2428	76	2445.5	111	2463
7	2411	42	2428.5	77	2446	112	2463.5
8	2411.5	43	2429	78	2446.5	113	2464
9	2412	44	2429.5	79	2447	114	2464.5
10	2412.5	45	2430	80	2447.5	115	2465
11	2413	46	2430.5	81	2448	116	2465.5
12	2413.5	47	2431	82	2448.5	117	2466
13	2414	48	2431.5	83	2449	118	2466.5
14	2414.5	49	2432	84	2449.5	119	2467
15	2415	50	2432.5	85	2450	120	2467.5
16	2415.5	51	2433	86	2450.5	121	2468
17	2416	52	2433.5	87	2451	122	2468.5
18	2416.5	53	2434	88	2451.5	123	2469
19	2417	54	2434.5	89	2452	124	2469.5
20	2417.5	55	2435	90	2452.5	125	2470
21	2418	56	2435.5	91	2453	126	2470.5
22	2418.5	57	2436	92	2453.5	127	2471
23	2419	58	2436.5	93	2454	128	2471.5
24	2419.5	59	2437	94	2454.5	129	2472
25	2420	60	2437.5	95	2455	130	2472.5
26	2420.5	61	2438	96	2455.5	131	2473
27	2421	62	2438.5	97	2456	132	2473.5
28	2421.5	63	2439	98	2456.5	133	2474
29	2422	64	2439.5	99	2457	134	2474.5
30	2422.5	65	2440	100	2457.5	135	2475
31	2423	66	2440.5	101	2458		
32	2423.5	67	2441	102	2458.5		
33	2424	68	2441.5	103	2459		
34	2424.5	69	2442	104	2459.5		
35	2425	70	2442.5	105	2460		

5.2 Test mode

Transmitting mode	Keep the EUT in transmitting mode.
-------------------	------------------------------------

5.3 Test Facility

<p>The test facility is recognized, certified, or accredited by the following organizations:</p> <ul style="list-style-type: none">● FCC —Registration No.: 381383 Designation Number: CN5029 Global United Technology Services Co., Ltd., Shenzhen EMC Laboratory has been registered and fully described in a report filed with the (FCC) Federal Communications Commission. The acceptance letter from the FCC is maintained in files.● ISED—Registration No.: 9079A CAB identifier: CN0091 The 3m Semi-anechoic chamber of Global United Technology Services Co., Ltd. has been registered by Certification and Engineering Bureau of ISED for radio equipment testing.● NVLAP (LAB CODE:600179-0) Global United Technology Services Co., Ltd., is accredited by the National Voluntary Laboratory Accreditation Program (NVLAP).
--

5.4 Test Location

All other tests were performed at:
Global United Technology Services Co., Ltd. Address: No. 123-128, Tower A, Jinyuan Business Building, No.2, Laodong Industrial Zone, Xixiang Road, Baoan District, Shenzhen, Guangdong, China 518102 Tel: 0755-27798480 Fax: 0755-27798960

5.5 Description of Support Units

None.

5.6 Deviation from Standards

None.

5.7 Abnormalities from Standard Conditions

None.

5.8 Additional Instructions

Software (Used for test) from client
Built-in by manufacturer, power set default.

6 Test Instruments list

Radiated Emission:						
Item	Test Equipment	Manufacturer	Model No.	Inventory No.	Cal.Date (mm-dd-yy)	Cal.Due date (mm-dd-yy)
1	3m Semi- Anechoic Chamber	ZhongYu Electron	9.2(L)*6.2(W)* 6.4(H)	GTS250	June 23, 2021	June 22, 2024
2	Control Room	ZhongYu Electron	6.2(L)*2.5(W)* 2.4(H)	GTS251	N/A	N/A
3	EMI Test Receiver	Rohde & Schwarz	ESU26	GTS203	April 14, 2023	April 13, 2024
4	BiConiLog Antenna	SCHWARZBECK MESS-ELEKTRONIK	VULB9168	GTS640	March 19, 2023	March 18, 2025
5	Double -ridged waveguide horn	SCHWARZBECK MESS-ELEKTRONIK	BBHA 9120 D	GTS208	April 17, 2023	April 16, 2025
6	EMI Test Software	AUDIX	E3	N/A	N/A	N/A
7	Wideband Radio Communication Tester	Rohde & Schwarz	CMW500	GTS575	April 14, 2023	April 13, 2024
8	Loop Antenna	ZHINAN	ZN30900A	GTS534	Nov. 13, 2023	Nov.12, 2024
9	Broadband Preamplifier	SCHWARZBECK	BBV9718	GTS535	April 14, 2023	April 13, 2024
10	Amplifier(1GHz-26.5GHz)	HP	8449B	GTS601	April 14, 2023	April 13, 2024
11	Horn Antenna (18-26.5GHz)	/	UG-598A/U	GTS664	Oct. 29, 2023	Oct. 28, 2024
12	Horn Antenna (26.5-40GHz)	A.H Systems	SAS-573	GTS665	Oct. 29, 2023	Oct. 28, 2024
13	FSV·Signal Analyzer (10Hz-40GHz)	Keysight	FSV-40-N	GTS666	March 12, 2024	March 11, 2025
14	Amplifier	/	LNA-1000-30S	GTS650	April 14, 2023	April 13, 2024
15	CDNE M2+M3-16A	HCT	30MHz-300MHz	GTS692	Nov. 08, 2023	Nov.07, 2024
16	Wideband Amplifier	/	WDA-01004000-15P35	GTS602	April 14, 2023	April 13, 2024
17	Thermo meter	JINCHUANG	GSP-8A	GTS643	April 19, 2023	April 18, 2024
18	RE cable 1	GTS	N/A	GTS675	July 31. 2023	July 30. 2024
19	RE cable 2	GTS	N/A	GTS676	July 31. 2023	July 30. 2024
20	RE cable 3	GTS	N/A	GTS677	July 31. 2023	July 30. 2024
21	RE cable 4	GTS	N/A	GTS678	July 31. 2023	July 30. 2024
22	RE cable 5	GTS	N/A	GTS679	July 31. 2023	July 30. 2024
23	RE cable 6	GTS	N/A	GTS680	July 31. 2023	July 30. 2024
24	RE cable 7	GTS	N/A	GTS681	July 31. 2023	July 30. 2024
25	RE cable 8	GTS	N/A	GTS682	July 31. 2023	July 30. 2024

RF Conducted Test:						
Item	Test Equipment	Manufacturer	Model No.	Serial No.	Cal.Date (mm-dd-yy)	Cal.Due date (mm-dd-yy)
1	MXA Signal Analyzer	Agilent	N9020A	GTS566	April 14, 2023	April 13, 2024
2	EMI Test Receiver	R&S	ESCI 7	GTS552	April 14, 2023	April 13, 2024
3	PSA Series Spectrum Analyzer	Agilent	E4440A	GTS536	April 14, 2023	April 13, 2024
4	MXG vector Signal Generator	Agilent	N5182A	GTS567	April 14, 2023	April 13, 2024
5	ESG Analog Signal Generator	Agilent	E4428C	GTS568	April 14, 2023	April 13, 2024
6	USB RF Power Sensor	DARE	RPR3006W	GTS569	April 14, 2023	April 13, 2024
7	RF Switch Box	Shongyi	RFSW3003328	GTS571	April 14, 2023	April 13, 2024
8	Programmable Constant Temp & Humi Test Chamber	WEWON	WHTH-150L-40-880	GTS572	April 14, 2023	April 13, 2024
9	Thermo meter	JINCHUANG	GSP-8A	GTS641	April 19, 2023	April 18, 2024

General used equipment:						
Item	Test Equipment	Manufacturer	Model No.	Inventory No.	Cal.Date (mm-dd-yy)	Cal.Due date (mm-dd-yy)
1	Barometer	KUMAO	SF132	GTS647	April 19, 2023	April 18, 2024

7 Test results and Measurement Data

7.1 Antenna requirement

Standard requirement:	FCC Part15 C Section 15.203 /247(c)
15.203 requirement: An intentional radiator shall be designed to ensure that no antenna other than that furnished by the responsible party shall be used with the device. The use of a permanently attached antenna or of an antenna that uses a unique coupling to the intentional radiator, the manufacturer may design the unit so that a broken antenna can be replaced by the user, but the use of a standard antenna jack or electrical connector is prohibited.	
15.247(c) (1)(i) requirement: (i) Systems operating in the 2400-2483.5 MHz band that is used exclusively for fixed. Point-to-point operations may employ transmitting antennas with directional gain greater than 6dBi provided the maximum conducted output power of the intentional radiator is reduced by 1 dB for every 3 dB that the directional gain of the antenna exceeds 6dBi.	
EUT Antenna:	
The antenna is PCB antenna, reference to the appendix II for details.	

7.2 Conducted Peak Output Power

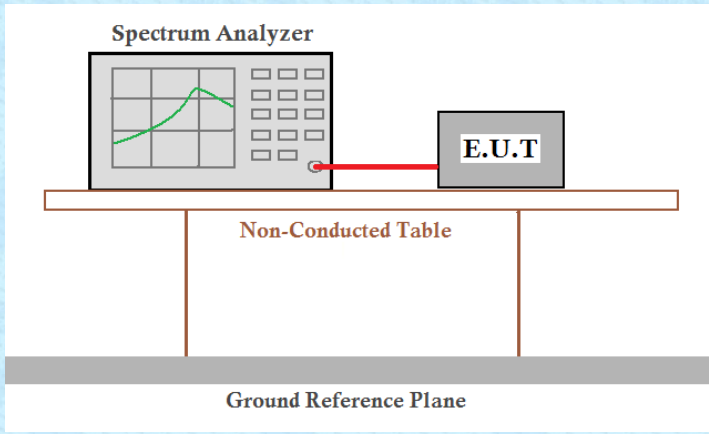
Test Requirement:	FCC Part15 C Section 15.247(a)(1)
Test Method:	ANSI C63.10:2013
Limit:	20.97dBm
Test setup:	 <p>The diagram illustrates the test setup. A Spectrum Analyzer is connected to an E.U.T. (Equipment Under Test) via a red cable. Both are placed on a Non-Conducted Table, which sits on a Ground Reference Plane.</p>
Test Instruments:	Refer to section 6.0 for details
Test mode:	Refer to section 5.2 for details
Test results:	Pass

Measurement Data: The detailed test data see Appendix for 2.4G.

7.3 20dB Emission Bandwidth

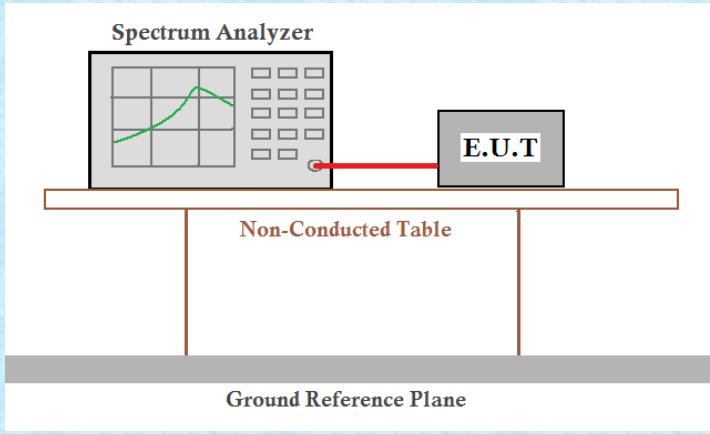
Test Requirement:	FCC Part15 C Section 15.247 (a)(1)
Test Method:	ANSI C63.10:2013
Limit:	N/A
Test setup:	 <p>The diagram illustrates the test setup. A Spectrum Analyzer is connected to an E.U.T. (Equipment Under Test) via a red cable. Both are placed on a Non-Conducted Table, which is supported by a Ground Reference Plane.</p>
Test Instruments:	Refer to section 6.0 for details
Test mode:	Refer to section 5.2 for details
Test results:	Pass

Measurement Data: The detailed test data see Appendix for 2.4G.

7.4 Carrier Frequencies Separation

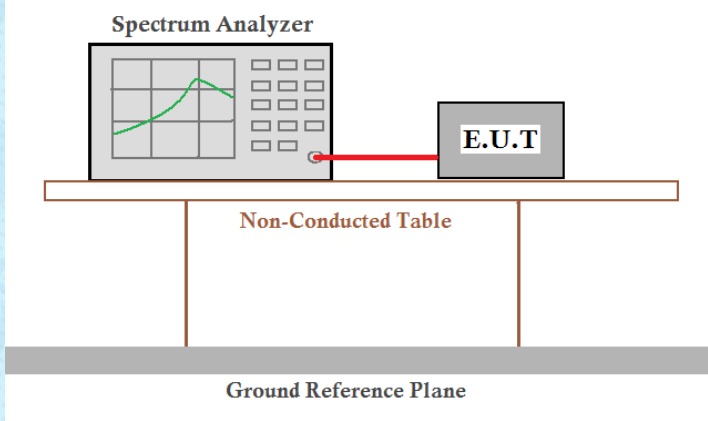
Test Requirement:	FCC Part15 C Section 15.247 (a)(1)
Test Method:	ANSI C63.10:2013
Receiver setup:	RBW=300KHz, VBW=300KHz, detector=Peak
Limit:	0.025MHz or 2/3 of the 20dB bandwidth (whichever is greater)
Test setup:	 <p>The diagram illustrates the test setup. A Spectrum Analyzer is connected to an E.U.T. (Equipment Under Test) via a red cable. Both are placed on a Non-Conducted Table, which is supported by a Ground Reference Plane.</p>
Test Instruments:	Refer to section 6.0 for details
Test mode:	Refer to section 5.2 for details
Test results:	Pass

Measurement Data: The detailed test data see Appendix for 2.4G.

7.5 Hopping Channel Number

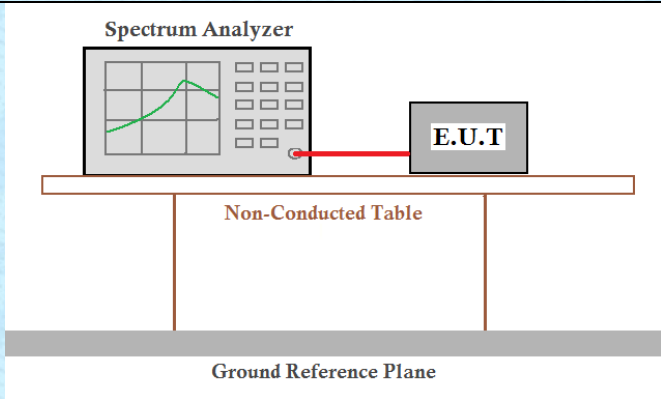
Test Requirement:	FCC Part15 C Section 15.247 (a)(1)(iii)
Test Method:	ANSI C63.10:2013
Receiver setup:	RBW=300kHz, VBW=300kHz, Frequency range=2400MHz-2483.5MHz, Detector=Peak
Limit:	15 channels
Test setup:	 <p>The diagram illustrates the test setup. A Spectrum Analyzer is connected to an E.U.T. (Equipment Under Test) via a red cable. Both are placed on a Non-Conducted Table, which sits on a Ground Reference Plane.</p>
Test Instruments:	Refer to section 6.0 for details
Test mode:	Refer to section 5.2 for details
Test results:	Pass

Measurement Data: The detailed test data see Appendix for 2.4G.

7.6 Dwell Time

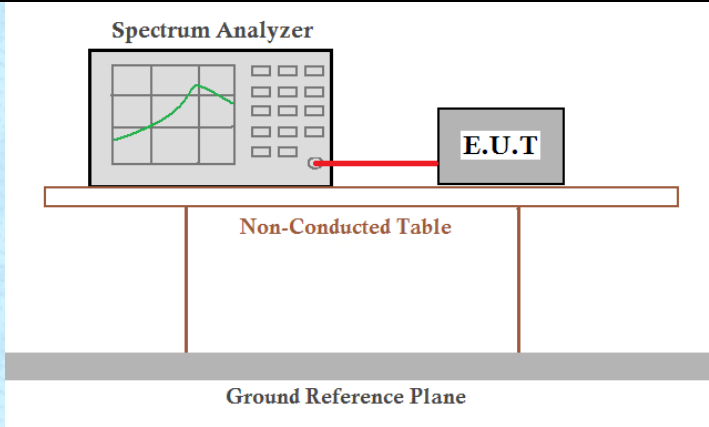
Test Requirement:	FCC Part15 C Section 15.247 (a)(1)(iii)
Test Method:	ANSI C63.10:2013
Receiver setup:	RBW=300KHz, VBW=300KHz, Span=0Hz, Detector=Peak
Limit:	0.4 Second
Test setup:	 <p>The diagram illustrates the test setup. A Spectrum Analyzer is connected to an E.U.T. (Equipment Under Test) via a red cable. Both are placed on a Non-Conducted Table, which is supported by a Ground Reference Plane.</p>
Test Instruments:	Refer to section 6.0 for details
Test mode:	Refer to section 5.2 for details
Test results:	Pass

Measurement Data: The detailed test data see Appendix for 2.4G.

7.7 Spurious Emission in Non-restricted & restricted Bands

7.7.1 Conducted Emission Method

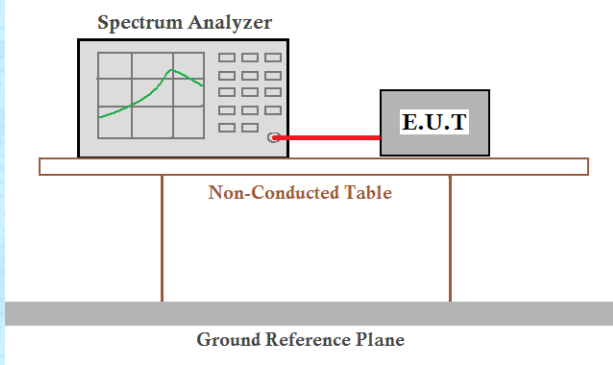
Test Requirement:	FCC Part15 C Section 15.247 (d)
Test Method:	ANSI C63.10:2013
Receiver setup:	RBW=100kHz, VBW=300kHz, Detector=Peak
Limit:	In any 100 kHz bandwidth outside the frequency band in which the spread spectrum intentional radiator is operating, the radio frequency power that is produced by the intentional radiator shall be at least 20 dB below that in the 100 kHz bandwidth within the band that contains the highest level of the desired power, based on either an RF conducted or a radiated measurement.
Test setup:	 <p>The diagram illustrates the test setup. A Spectrum Analyzer is connected to an E.U.T. (Equipment Under Test) via a red cable. Both are placed on a Non-Conducted Table, which sits on a Ground Reference Plane.</p>
Test Instruments:	Refer to section6.0 for details
Test mode:	Refer to section 5.2 for details
Test results:	Pass

Measurement Data: The detailed test data see Appendix for 2.4G.

7.7.2 Radiated Emission Method

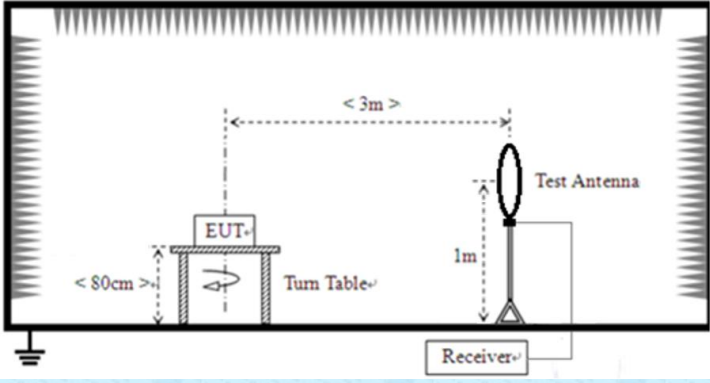
Test Requirement:	FCC Part15 C Section 15.209 and 15.205				
Test Method:	ANSI C63.10:2013				
Test Frequency Range:	9kHz to 25GHz				
Test site:	Measurement Distance: 3m				
Receiver setup:	Frequency	Detector	RBW	VBW	Value
	9KHz-150KHz	Quasi-peak	200Hz	600Hz	Quasi-peak
	150KHz-30MHz	Quasi-peak	9KHz	30KHz	Quasi-peak
	30MHz-1GHz	Quasi-peak	120KHz	300KHz	Quasi-peak
	Above 1GHz	Peak	1MHz	3MHz	Peak
		Peak	1MHz	10Hz	Average
Note: For Duty cycle $\geq 98\%$, average detector set as above For Duty cycle $< 98\%$, average detector set as below: $VBW \geq 1 / T$					
Limit: (Spurious Emissions)	Frequency	Limit (uV/m)	Value	Measurement Distance	
	0.009MHz-0.490MHz	2400/F(KHz)	PK/QP/AV	300m	
	0.490MHz-1.705MHz	24000/F(KHz)	QP	30m	
	1.705MHz-30MHz	30	QP	30m	
	30MHz-88MHz	100	QP	3m	
	88MHz-216MHz	150	QP		
	216MHz-960MHz	200	QP		
	960MHz-1GHz	500	QP		
	Above 1GHz	500	Average		
		5000	Peak		
Test setup:	Below 30MHz				
					
Below 1GHz					

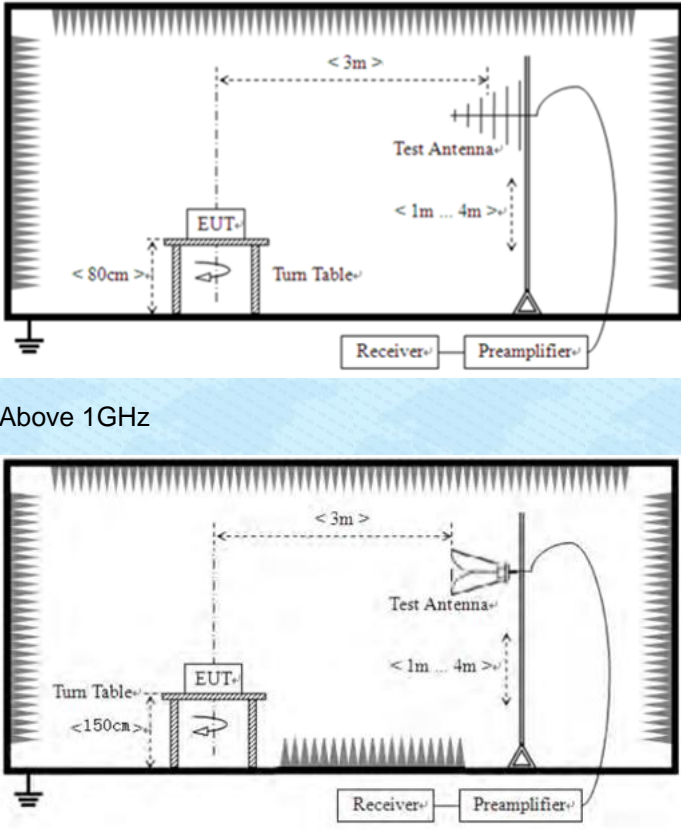
	 <p>Above 1GHz</p>						
<p>Test Procedure:</p>	<ol style="list-style-type: none"> 1. The EUT was placed on the top of a rotating table (0.8 meters for below 1GHz and 1.5meters for above 1GHz) above the ground at a 3 meter camber. The table was rotated 360 degrees to determine the position of the highest radiation. 2. The EUT was set 3 meters away from the interference-receiving antenna, which was mounted on the top of a variable-height antenna tower. 3. The antenna height is varied from one meter to four meters above the ground to determine the maximum value of the field strength. Both horizontal and vertical polarizations of the antenna are set to make the measurement. 4. For each suspected emission, the EUT was arranged to its worst case and then the antenna was tuned to heights from 1 meter to 4 meters and the rota table was turned from 0 degrees to 360 degrees to find the maximum reading. 5. The test-receiver system was set to Peak Detect Function and Specified Bandwidth with Maximum Hold Mode. 6. If the emission level of the EUT in peak mode was 10dB lower than the limit specified, then testing could be stopped and the peak values of the EUT would be reported. Otherwise the emissions that did not have 10dB margin would be re-tested one by one using peak, quasi-peak or average method as specified and then reported in a data sheet. 						
<p>Test Instruments:</p>	<p>Refer to section 5.8 for details</p>						
<p>Test mode:</p>	<p>Refer to section 5.2 for details</p>						
<p>Temp. / Hum.</p>	<table border="1"> <tr> <td>Temp.:</td> <td>25 °C</td> <td>Humid.:</td> <td>52%</td> <td>Press.:</td> <td>1 012mbar</td> </tr> </table>	Temp.:	25 °C	Humid.:	52%	Press.:	1 012mbar
Temp.:	25 °C	Humid.:	52%	Press.:	1 012mbar		

Test results:	Pass
---------------	------

Remark:

1. Pre-scan all kind of the place mode (X-axis, Y-axis, Z-axis), and found the Y-axis which it is worse case.

Measurement data:

■ **Below 30MHz**

The low frequency, which started from 9 kHz to 30 MHz, was pre-scanned and the result which was 20 dB lower than the limit line per 15.31(o) was not reported.

30MHz ~ 1GHz

Test channel:	Lowest	Polarization:	Horizontal
---------------	--------	---------------	------------

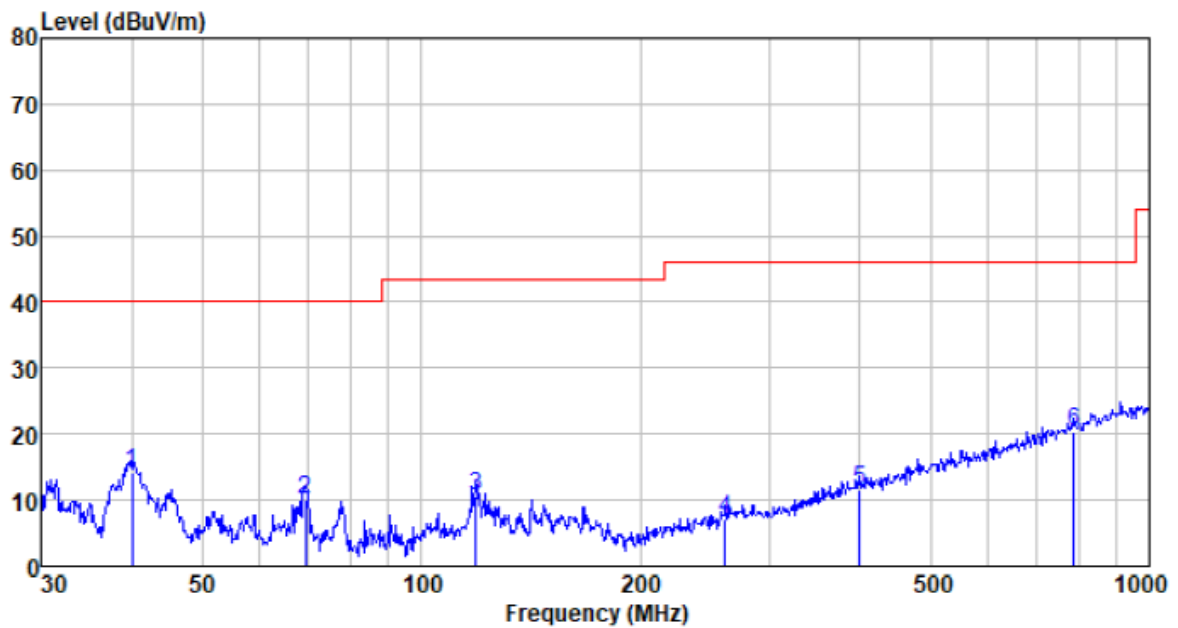

Freq MHz	Reading level dBuV	Antenna factor dB/m	Cable loss dB	Preamp factor dB	level dBuV/m	Limit level dBuV/m	Over limit dB	Remark
39.994	33.64	13.50	0.66	33.73	14.07	40.00	-25.93	QP
69.357	32.16	10.63	0.94	33.60	10.13	40.00	-29.87	QP
118.601	31.51	11.10	1.35	33.40	10.56	43.50	-32.94	QP
261.058	26.30	11.39	2.18	32.73	7.14	46.00	-38.86	QP
400.432	25.36	15.71	2.85	32.30	11.62	46.00	-34.38	QP
787.851	24.88	22.48	4.41	31.30	20.47	46.00	-25.53	QP

Test channel:	Lowest	Polarization:	Vertical
---------------	--------	---------------	----------

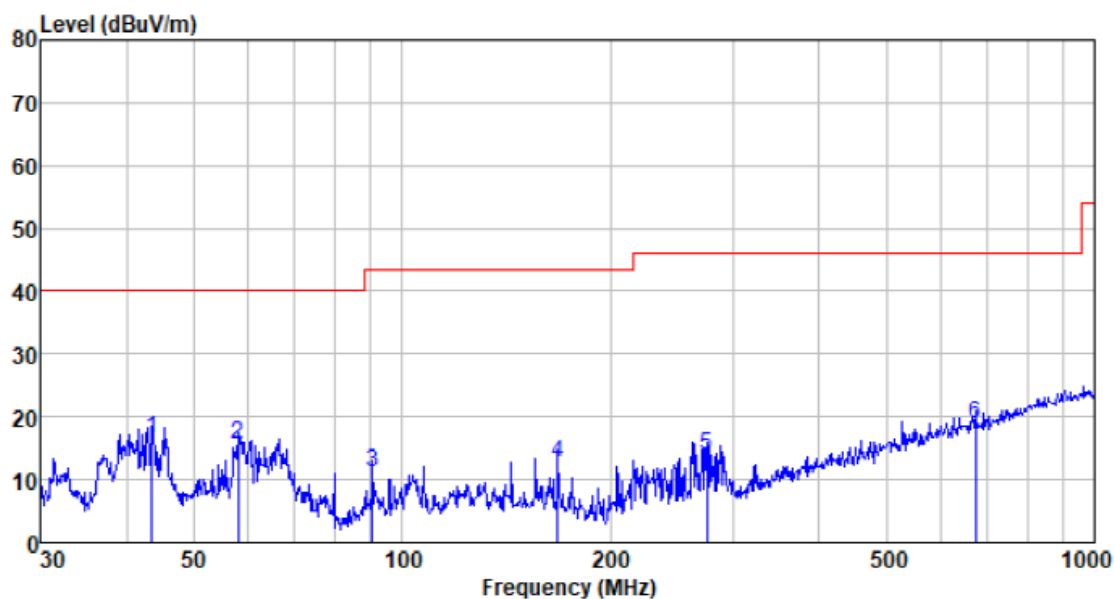

Freq MHz	Reading level dBuV	Antenna factor dB/m	Cable loss dB	Preamp factor dB	level dBuV/m	Limit level dBuV/m	Over limit dB	Remark
43.506	36.08	13.39	0.70	33.71	16.46	40.00	-23.54	QP
57.999	35.63	12.71	0.84	33.64	15.54	40.00	-24.46	QP
90.537	34.93	8.66	1.11	33.60	11.10	43.50	-32.40	QP
167.824	32.45	11.67	1.67	33.00	12.79	43.50	-30.71	QP
275.157	31.87	12.52	2.25	32.72	13.92	46.00	-32.08	QP
672.845	26.22	20.41	3.99	31.65	18.97	46.00	-27.03	QP

Test channel:	Middle	Polarization:	Horizontal
---------------	--------	---------------	------------

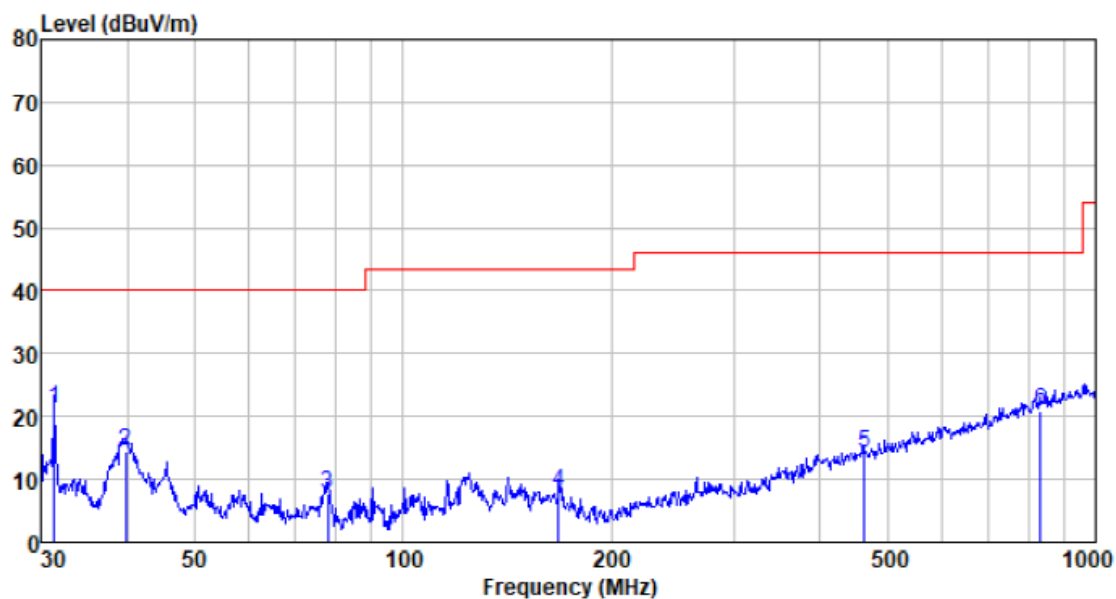

Freq MHz	Reading level dBuV	Antenna factor dB/m	Cable loss dB	Preamp factor dB	level dBuV/m	Limit level dBuV/m	Over limit dB	Remark
31.399	42.32	12.28	0.57	33.79	21.38	40.00	-18.62	QP
39.715	34.18	13.46	0.66	33.73	14.57	40.00	-25.43	QP
77.865	30.92	9.22	1.01	33.60	7.55	40.00	-32.45	QP
167.824	27.69	11.67	1.67	33.00	8.03	43.50	-35.47	QP
463.970	26.06	16.96	3.15	32.10	14.07	46.00	-31.93	QP
833.317	24.52	23.12	4.58	31.16	21.06	46.00	-24.94	QP

Test channel:	Middle	Polarization:	Vertical
---------------	--------	---------------	----------

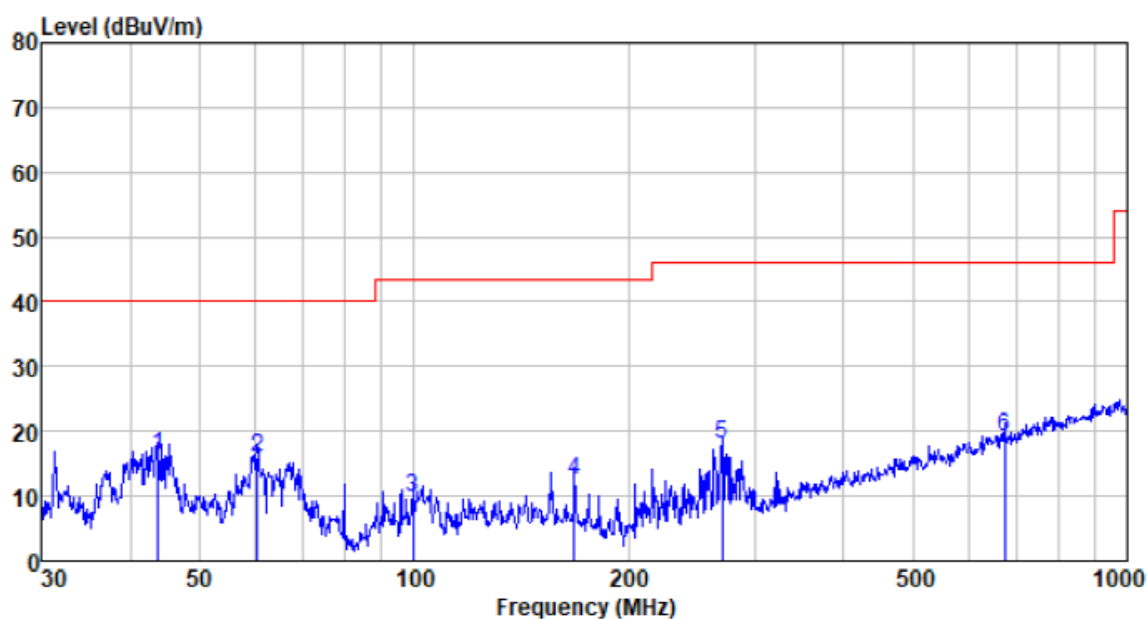

Freq MHz	Reading level dBuV	Antenna factor dB/m	Cable loss dB	Preamp factor dB	level dBuV/m	Limit level dBuV/m	Over limit dB	Remark
43.812	35.89	13.38	0.71	33.71	16.27	40.00	-23.73	QP
60.280	36.30	12.54	0.86	33.64	16.06	40.00	-23.94	QP
99.528	32.59	9.65	1.19	33.60	9.83	43.50	-33.67	QP
167.824	32.15	11.67	1.67	33.00	12.49	43.50	-31.01	QP
270.375	36.25	12.14	2.22	32.73	17.88	46.00	-28.12	QP
672.845	26.50	20.41	3.99	31.65	19.25	46.00	-26.75	QP

Test channel:	Highest	Polarization:	Horizontal
---------------	---------	---------------	------------

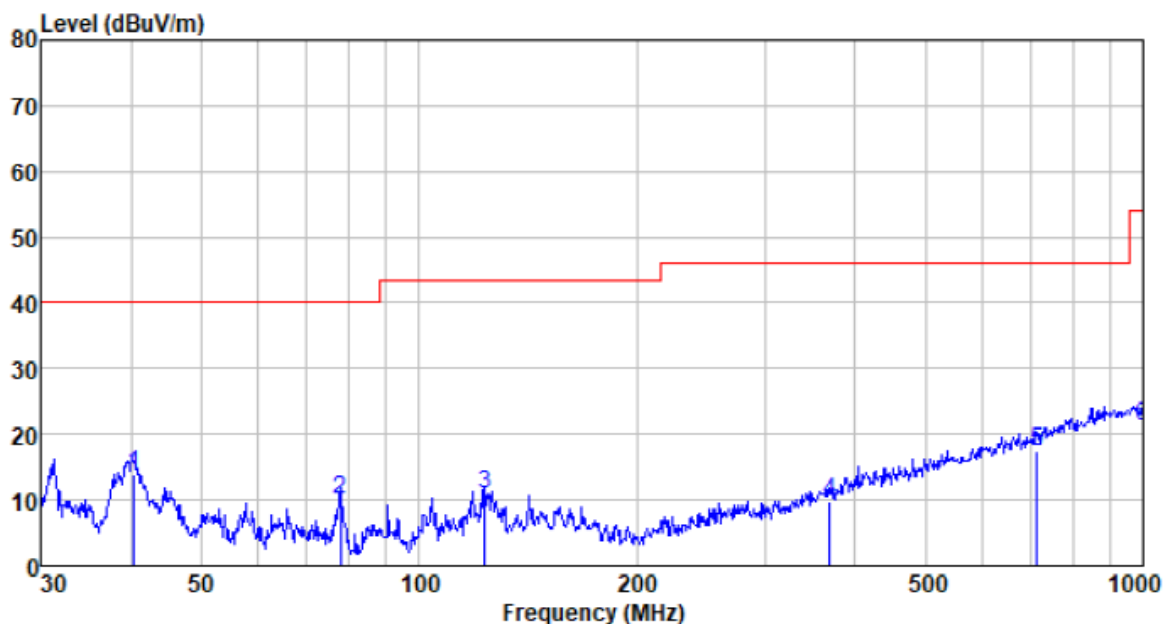

Freq MHz	Reading level dBuV	Antenna factor dB/m	Cable loss dB	Preamp factor dB	level dBuV/m	Limit level dBuV/m	Over limit dB	Remark
40.417	33.54	13.49	0.66	33.73	13.96	40.00	-26.04	QP
77.865	33.31	9.22	1.01	33.60	9.94	40.00	-30.06	QP
123.266	31.53	11.41	1.38	33.36	10.96	43.50	-32.54	QP
369.405	24.76	14.79	2.72	32.41	9.86	46.00	-36.14	QP
714.173	23.67	21.09	4.14	31.55	17.35	46.00	-28.65	QP
1000.000	22.11	24.70	5.22	30.70	21.33	54.00	-32.67	QP

Test channel:	Highest	Polarization:	Vertical
---------------	---------	---------------	----------

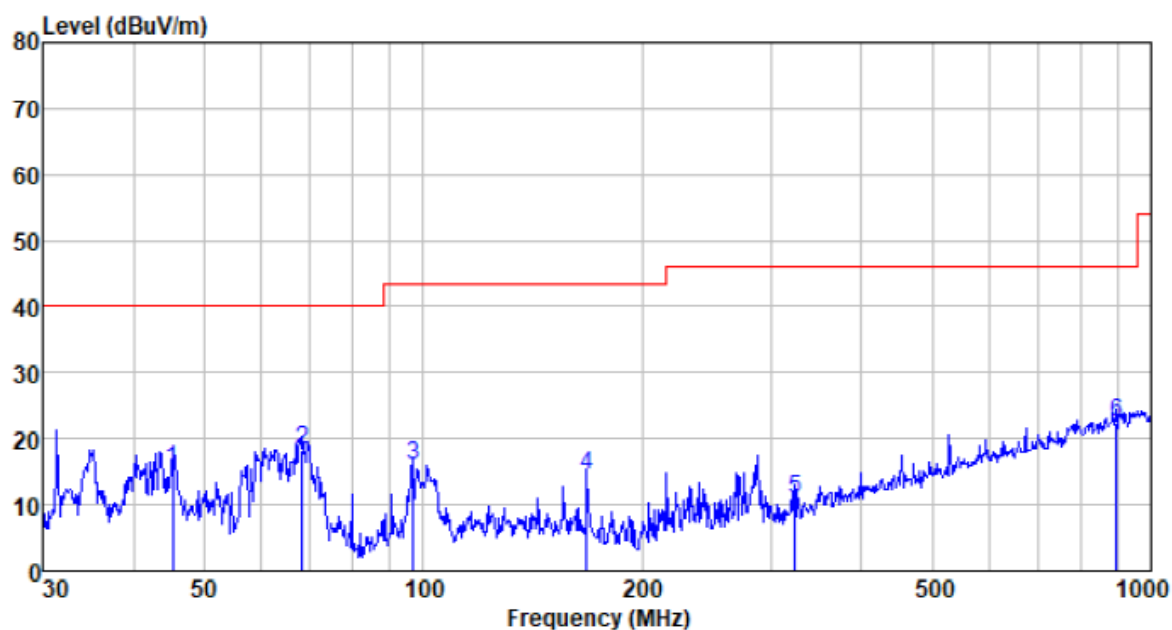

Freq MHz	Reading level dBuV	Antenna factor dB/m	Cable loss dB	Preamp factor dB	level dBuV/m	Limit level dBuV/m	Over limit dB	Remark
45.217	35.05	13.34	0.72	33.70	15.41	40.00	-24.59	QP
68.151	40.26	10.86	0.93	33.61	18.44	40.00	-21.56	QP
96.775	38.98	9.36	1.17	33.60	15.91	43.50	-27.59	QP
167.824	34.03	11.67	1.67	33.00	14.37	43.50	-29.13	QP
324.456	27.74	13.30	2.49	32.59	10.94	46.00	-35.06	QP
896.997	24.64	23.87	4.83	30.97	22.37	46.00	-23.63	QP

- Above 1GHz
- Unwanted Emissions in Non-restricted Frequency Bands

Test channel:	Lowest	Polarization:	Horizontal
---------------	--------	---------------	------------

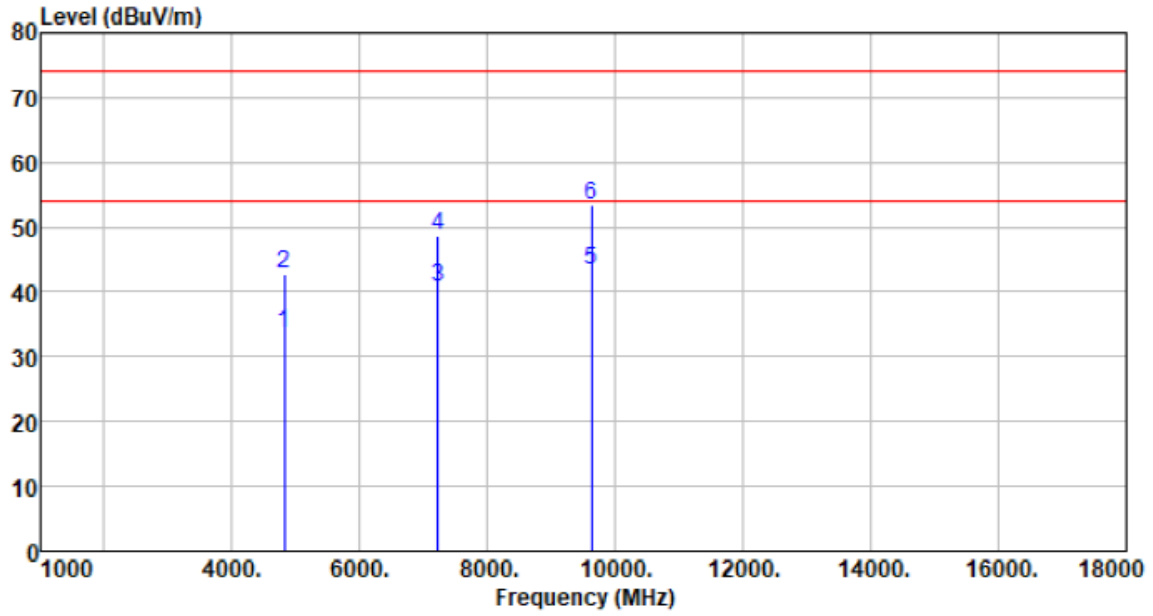

Freq MHz	Reading level dBuV	Antenna factor dB/m	Cable loss dB	Preamp factor dB	level dBuV/m	Limit level dBuV/m	Over limit dB	Remark
4816.000	33.68	31.08	7.30	38.36	33.70	54.00	-20.30	Average
4816.000	42.89	31.08	7.30	38.36	42.91	74.00	-31.09	Peak
7224.000	34.22	35.95	9.44	38.97	40.64	54.00	-13.36	Average
7224.000	42.42	35.95	9.44	38.97	48.84	74.00	-25.16	Peak
9632.000	35.24	37.93	10.01	39.69	43.49	54.00	-10.51	Average
9632.000	45.17	37.93	10.01	39.69	53.42	74.00	-20.58	Peak

Test channel:	Lowest	Polarization:	Vertical
---------------	--------	---------------	----------

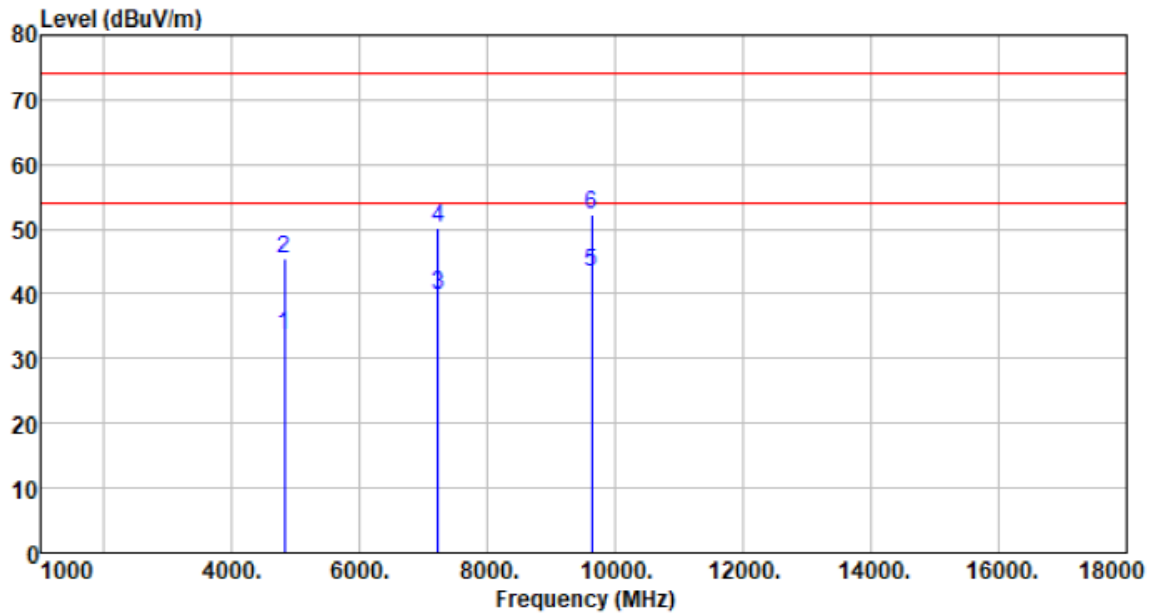

Freq MHz	Reading level dBuV	Antenna factor dB/m	Cable loss dB	Preamp factor dB	level dBuV/m	Limit level dBuV/m	Over limit dB	Remark
4816.000	33.49	31.08	7.30	38.36	33.51	54.00	-20.49	Average
4816.000	45.55	31.08	7.30	38.36	45.57	74.00	-28.43	Peak
7224.000	33.55	35.95	9.44	38.97	39.97	54.00	-14.03	Average
7224.000	43.71	35.95	9.44	38.97	50.13	74.00	-23.87	Peak
9632.000	35.16	37.93	10.01	39.69	43.41	54.00	-10.59	Average
9632.000	44.04	37.93	10.01	39.69	52.29	74.00	-21.71	Peak

Test channel:	Middle	Polarization:	Horizontal
---------------	--------	---------------	------------

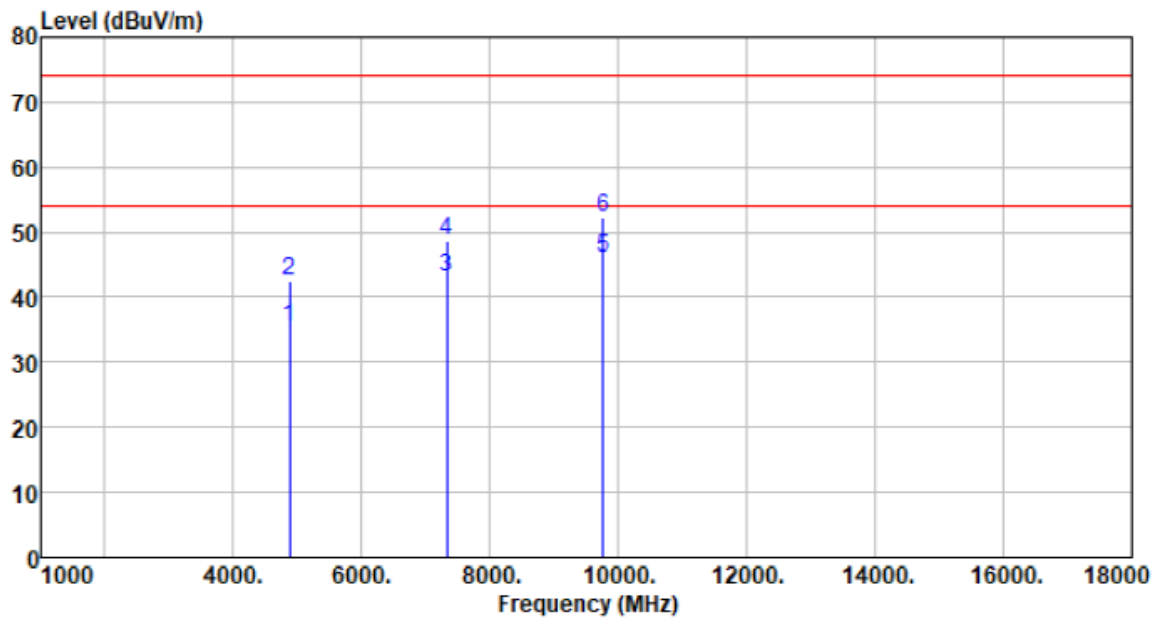

Freq MHz	Reading level dBuV	Antenna factor dB/m	Cable loss dB	Preamp factor dB	level dBuV/m	Limit level dBuV/m	Over limit dB	Remark
4880.000	35.50	31.26	7.04	38.38	35.42	54.00	-18.58	Average
4880.000	42.64	31.26	7.04	38.38	42.56	74.00	-31.44	Peak
7320.000	36.71	36.14	9.18	39.00	43.03	54.00	-10.97	Average
7320.000	42.44	36.14	9.18	39.00	48.76	74.00	-25.24	Peak
9760.000	37.41	38.06	10.27	39.73	46.01	54.00	-7.99	Average
9760.000	43.66	38.06	10.27	39.73	52.26	74.00	-21.74	Peak

Test channel:	Middle	Polarization:	Vertical
---------------	--------	---------------	----------

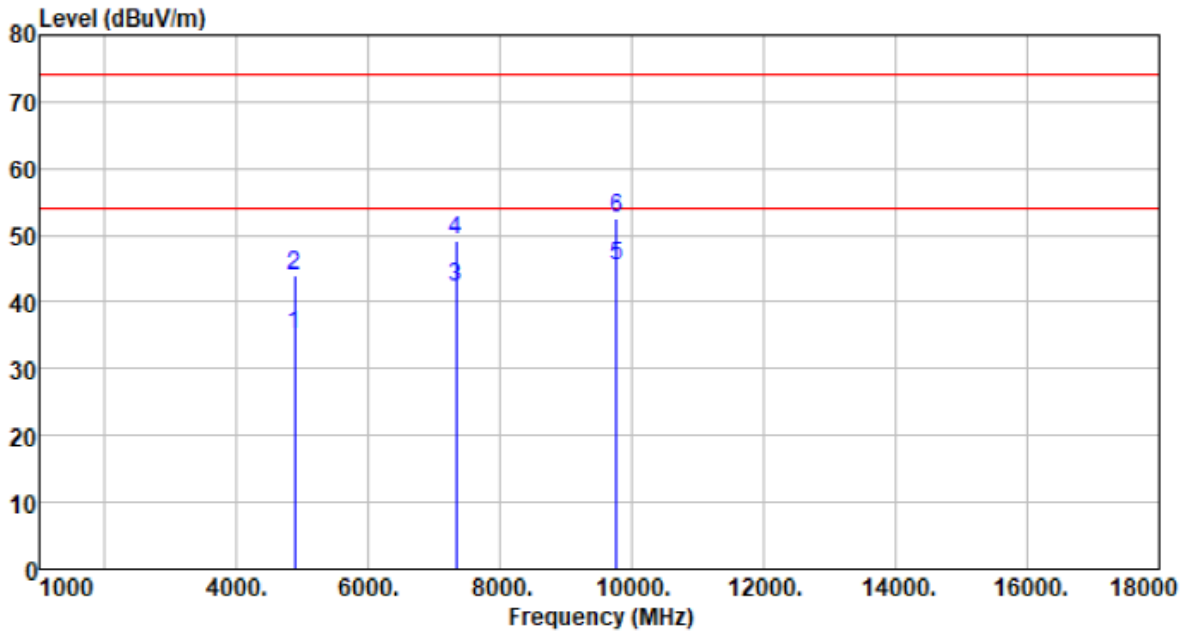

Freq MHz	Reading level dBuV	Antenna factor dB/m	Cable loss dB	Preamp factor dB	level dBuV/m	Limit level dBuV/m	Over limit dB	Remark
4880.000	35.27	31.26	7.04	38.38	35.19	54.00	-18.81	Average
4880.000	44.08	31.26	7.04	38.38	44.00	74.00	-30.00	Peak
7320.000	35.86	36.14	9.18	39.00	42.18	54.00	-11.82	Average
7320.000	42.96	36.14	9.18	39.00	49.28	74.00	-24.72	Peak
9760.000	36.73	38.06	10.27	39.73	45.33	54.00	-8.67	Average
9760.000	43.96	38.06	10.27	39.73	52.56	74.00	-21.44	Peak

Test channel:	Highest	Polarization:	Horizontal
---------------	---------	---------------	------------

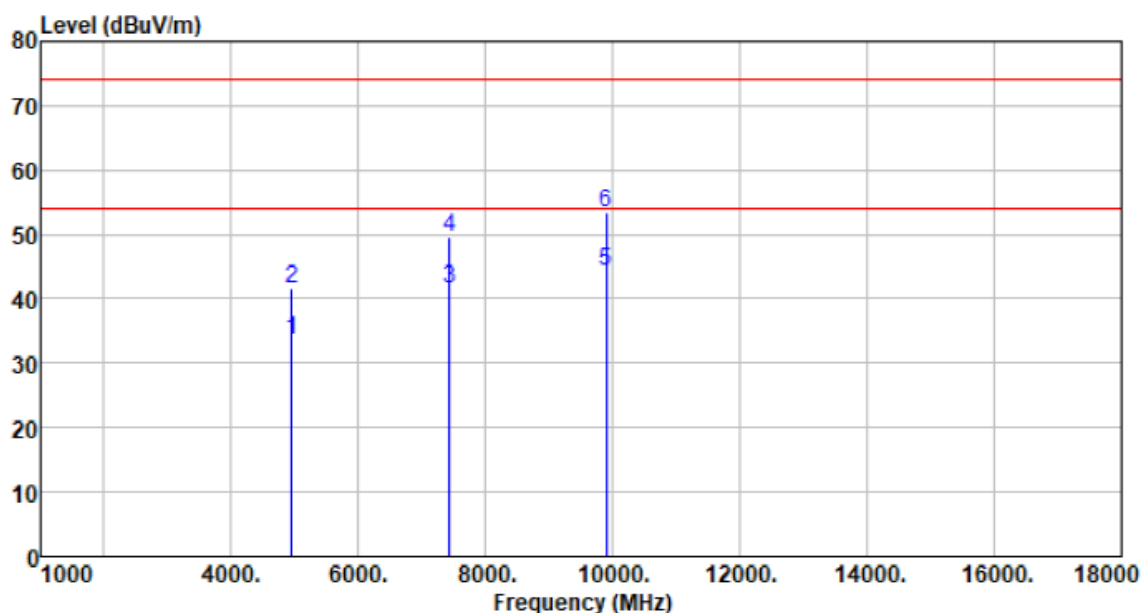

Freq MHz	Reading level dBuV	Antenna factor dB/m	Cable loss dB	Preamp factor dB	level dBuV/m	Limit level dBuV/m	Over limit dB	Remark
4950.000	33.82	31.46	6.75	38.39	33.64	54.00	-20.36	Average
4950.000	41.68	31.46	6.75	38.39	41.50	74.00	-32.50	Peak
7425.000	35.36	36.35	9.00	39.03	41.68	54.00	-12.32	Average
7425.000	43.19	36.35	9.00	39.03	49.51	74.00	-24.49	Peak
9900.000	35.63	38.20	10.12	39.77	44.18	54.00	-9.82	Average
9900.000	44.85	38.20	10.12	39.77	53.40	74.00	-20.60	Peak

Test channel:	Highest	Polarization:	Vertical
---------------	---------	---------------	----------

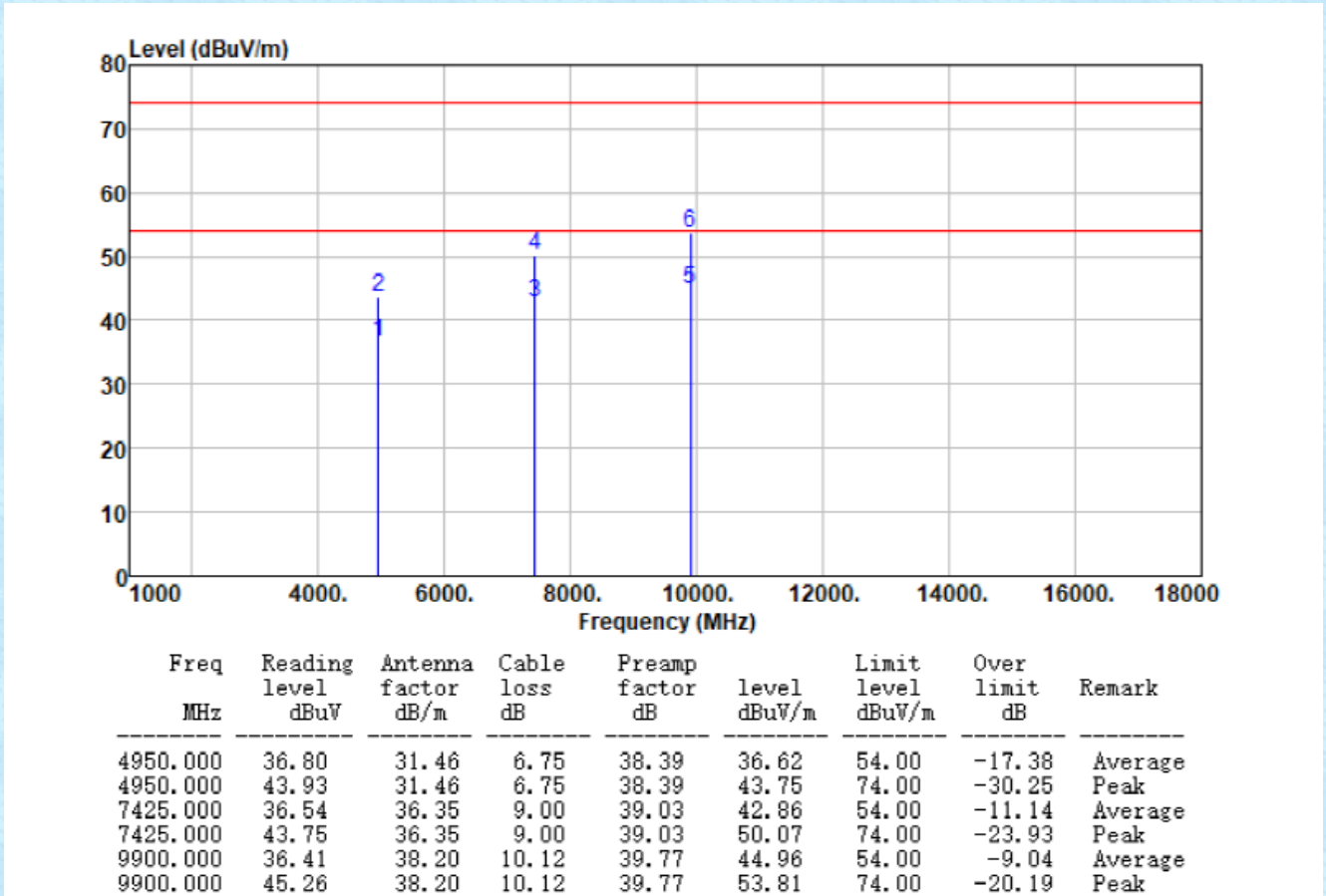

Remark:

1. Final Level = Receiver Read level + Antenna Factor + Cable Loss – Preamplifier Factor
2. The emission levels of other frequencies are very lower than the limit and not show in test report.
3. For above 18GHz, no emission found.

■ Unwanted Emissions in Restricted Frequency Bands

Test channel:	Lowest	Polarization:	Horizontal
---------------	--------	---------------	------------

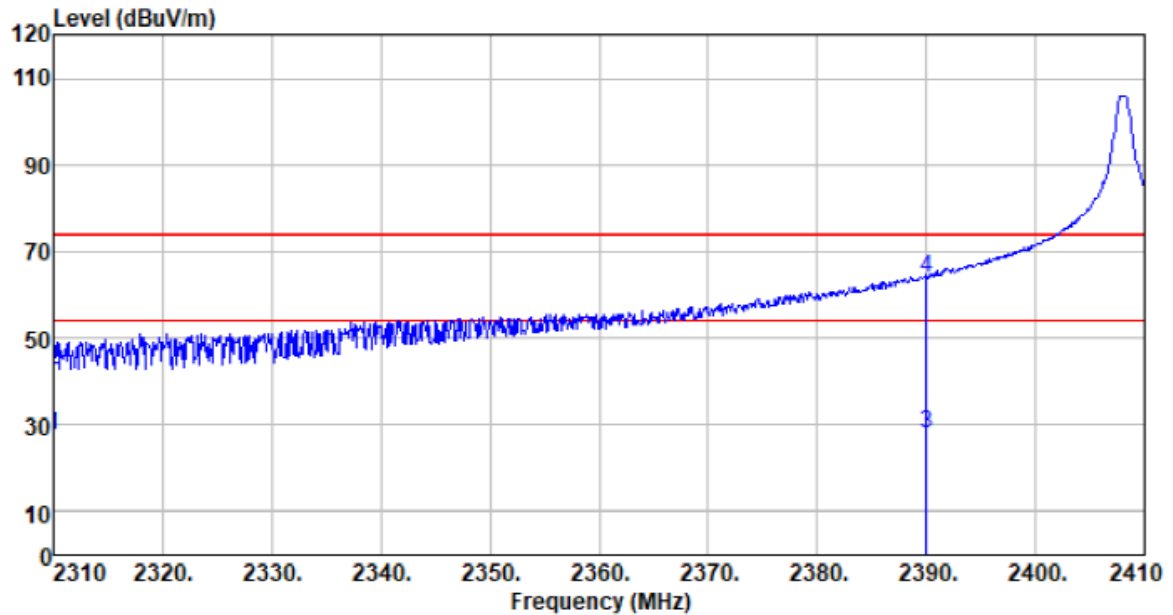

Freq MHz	Reading level dBuV	Antenna factor dB/m	Cable loss dB	Preamp factor dB	level dBuV/m	Limit level dBuV/m	Over limit dB	Remark
2310.000	34.41	27.17	4.60	38.52	27.66	54.00	-26.34	Average
2310.000	49.31	27.17	4.60	38.52	42.56	74.00	-31.44	Peak
2390.000	34.61	27.27	4.65	38.56	27.97	54.00	-26.03	Average
2390.000	70.41	27.27	4.65	38.56	63.77	74.00	-10.23	Peak

Test channel:	Lowest	Polarization:	Vertical
---------------	--------	---------------	----------

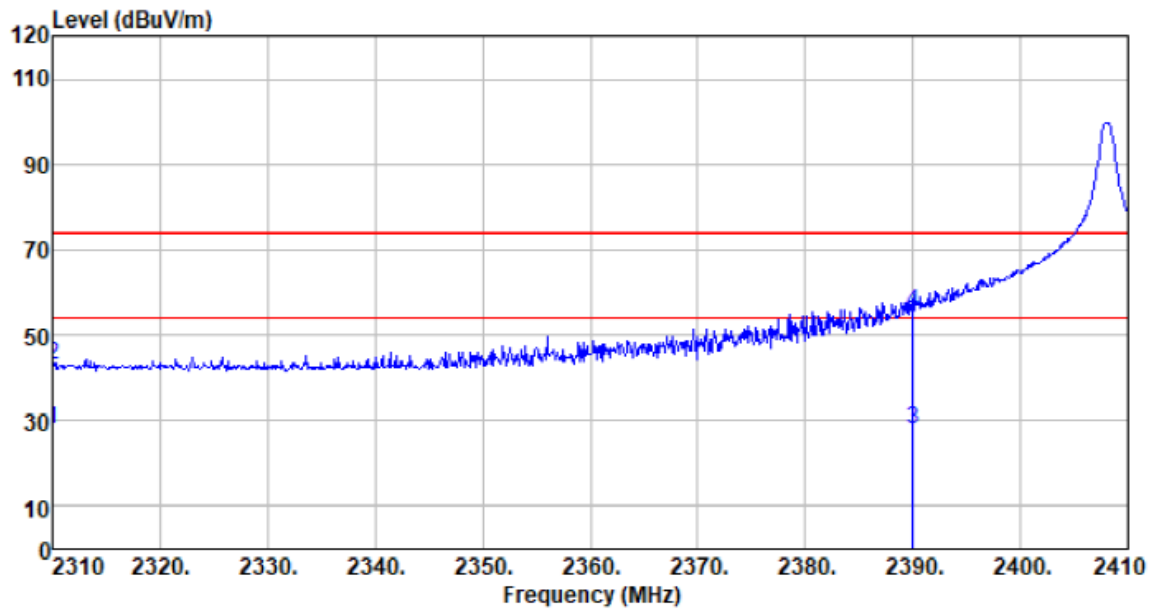

Freq MHz	Reading level dBuV	Antenna factor dB/m	Cable loss dB	Preamp factor dB	level dBuV/m	Limit level dBuV/m	Over limit dB	Remark
2310.000	34.48	27.17	4.60	38.52	27.73	54.00	-26.27	Average
2310.000	49.81	27.17	4.60	38.52	43.06	74.00	-30.94	Peak
2390.000	34.54	27.27	4.65	38.56	27.90	54.00	-26.10	Average
2390.000	61.88	27.27	4.65	38.56	55.24	74.00	-18.76	Peak

Test channel:	Highest	Polarization:	Horizontal
---------------	---------	---------------	------------

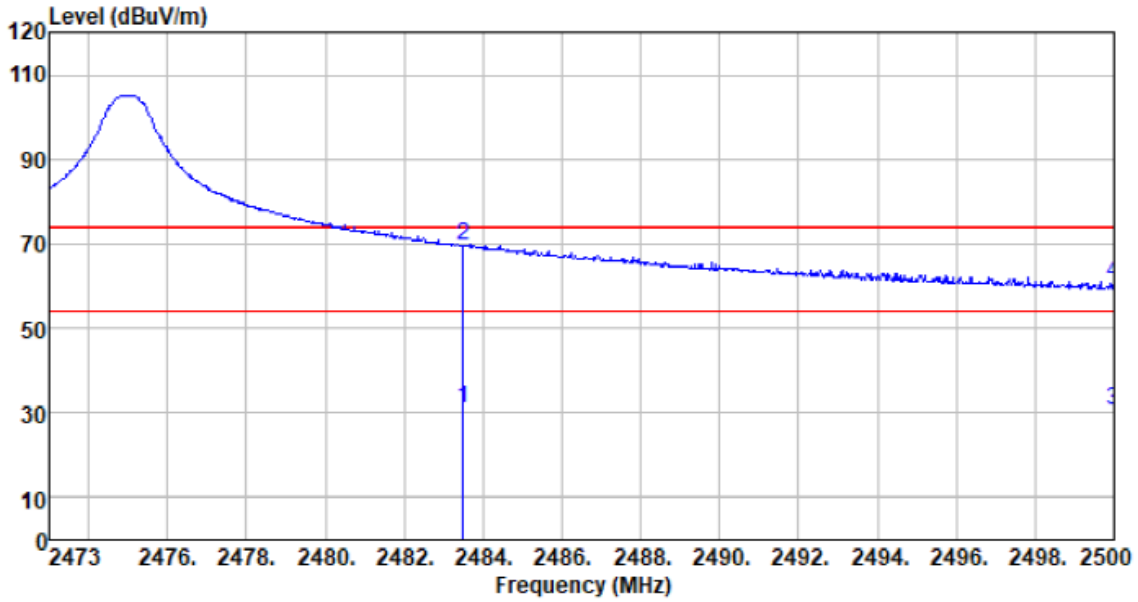

Freq MHz	Reading level dBuV	Antenna factor dB/m	Cable loss dB	Preamp factor dB	level dBuV/m	Limit level dBuV/m	Over limit dB	Remark
2483.500	37.63	27.38	4.52	38.59	30.94	54.00	-23.06	Average
2483.500	76.27	27.38	4.52	38.59	69.58	74.00	-4.42	Peak
2500.000	37.36	27.40	4.49	38.60	30.65	54.00	-23.35	Average
2500.000	67.41	27.40	4.49	38.60	60.70	74.00	-13.30	Peak

Test channel:	Highest	Polarization:	Vertical
---------------	---------	---------------	----------

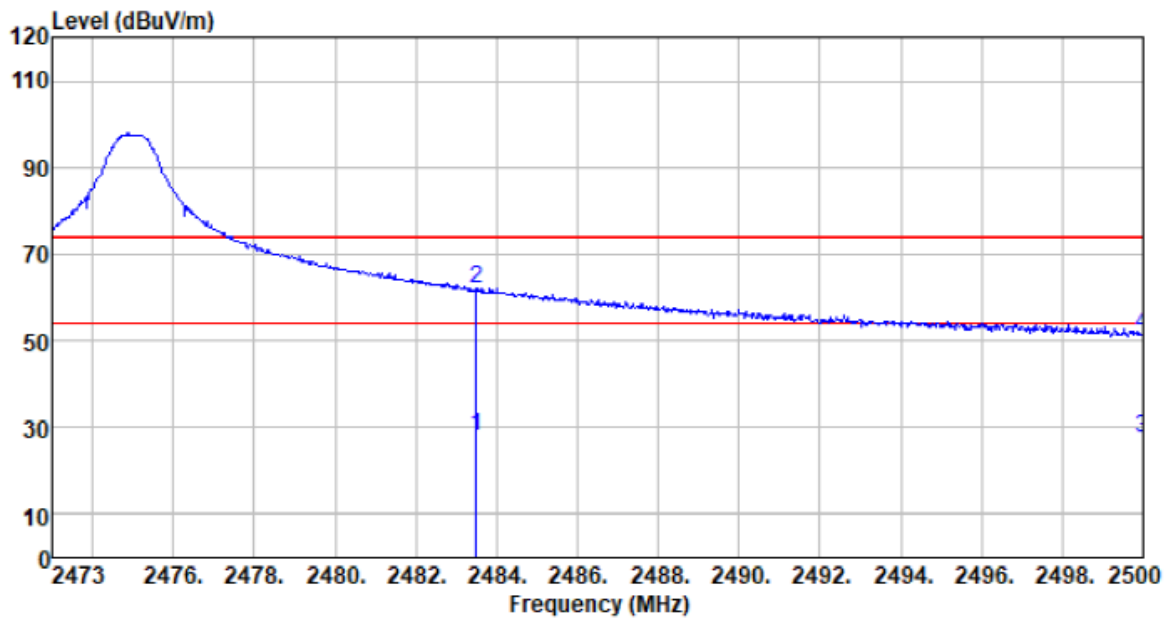

Freq MHz	Reading level dBuV	Antenna factor dB/m	Cable loss dB	Preamp factor dB	level dBuV/m	Limit level dBuV/m	Over limit dB	Remark
2483.500	34.77	27.38	4.52	38.59	28.08	54.00	-25.92	Average
2483.500	68.51	27.38	4.52	38.59	61.82	74.00	-12.18	Peak
2500.000	34.20	27.40	4.49	38.60	27.49	54.00	-26.51	Average
2500.000	58.24	27.40	4.49	38.60	51.53	74.00	-22.47	Peak

Remarks:

1. Final Level = Receiver Read level + Antenna Factor + Cable Loss – Preamplifier Factor
2. The emission levels of other frequencies are very lower than the limit and not show in test report.

8 Test Setup Photo

Reference to the **appendix I** for details.

9 EUT Constructional Details

Reference to the **appendix II** for details.

---End---