

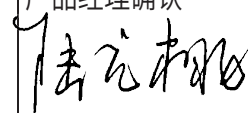

标记	处数	更改内容	签字	日期

产品经理确认

 日期

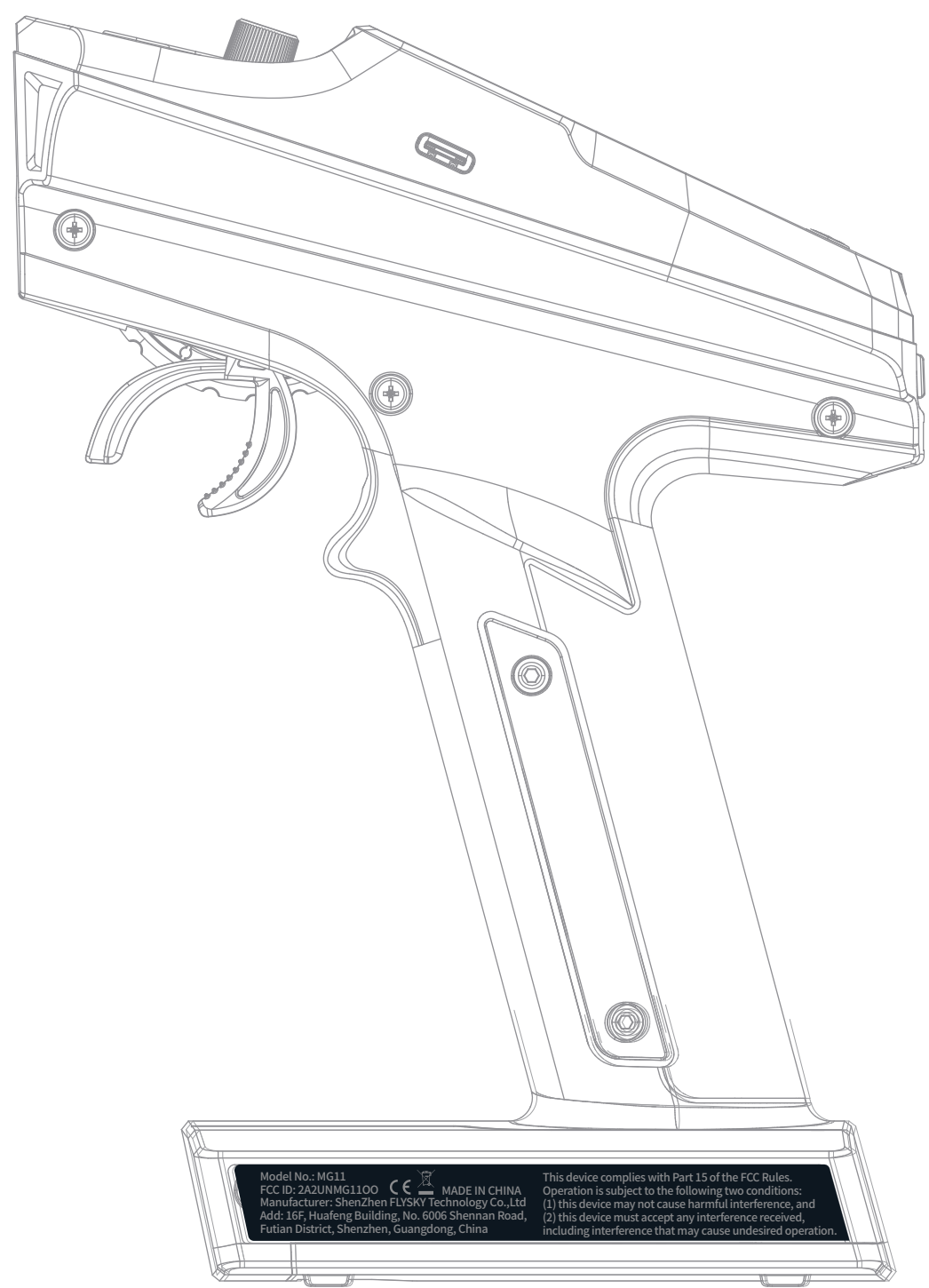





91.59mm

11.37mm

Model No.: MG11
 FCC ID: 2A2UNMG1100   MADE IN CHINA
 Manufacturer: ShenZhen FLYSKY Technology Co.,Ltd
 Add: 16F, Huafeng Building, No. 6006 Shennan Road,
 Futian District, Shenzhen, Guangdong, China

This device complies with Part 15 of the FCC Rules.
 Operation is subject to the following two conditions:
 (1) this device may not cause harmful interference, and
 (2) this device must accept any interference received,
 including interference that may cause undesired operation.

-  PANTONE 877C
-  PANTONE Black 6C

Model No.: MG11
 FCC ID: 2A2UNMG1100   MADE IN CHINA
 Manufacturer: ShenZhen FLYSKY Technology Co.,Ltd
 Add: 16F, Huafeng Building, No. 6006 Shennan Road,
 Futian District, Shenzhen, Guangdong, China

This device complies with Part 15 of the FCC Rules.
 Operation is subject to the following two conditions:
 (1) this device may not cause harmful interference, and
 (2) this device must accept any interference received,
 including interference that may cause undesired operation.

核准
日期
审查
日期
设计 古俞斌
日期 20231228

 **深圳市富斯科技有限公司**
 SHENZHEN FLYSKY TECHNOLOGY CO., LTD

注意：未注公差为正公差0.1，负公差0。

环保认证要求：(需要认证的请在方框内打勾)

- RoHS
- REACH
- PAHs
- Ca65
- WEEE

机 型	FS-MG11-BT-BS发射机	尺 寸	91.59*11.37mm	
名 称	FS-MG11-BT-BS 认证信息贴	材 质	0.175磨砂PC+513胶	
料 号	B-TFSGM11BTBS-03	色 相	彩色印刷	使用软件 Adobe Illustrator CC 2020
单 位	mm	比 例	1:1	版 次 01

