

# TEST REPORT

**Applicant:** ShenZhen FLYSKY Technology Co.,Ltd  
**Address of Applicant:** 16F, Huafeng Building, No. 6006 Shennan Road, Futian District, Shenzhen, Guangdong, China  
**Manufacturer:** ShenZhen FLYSKY Technology Co.,Ltd  
**Address of Manufacturer:** 16F, Huafeng Building, No. 6006 Shennan Road, Futian District, Shenzhen, Guangdong, China  
**Factory:** Dongguan Flysky RC Model technology Co.,Ltd  
**Address of Factory:** West building 3, HuangjinyuanInd Park, Qiaoli North Gate, Changping Town, Dongguan, China

### Equipment Under Test (EUT)

**Product Name:** 4-CHANNEL RECEIVER  
**Model No.:** FGr4D  
**Trade Mark:** FLYSKY  
**FCC ID:** 2A2UNFGR4D  
**Applicable standards:** FCC CFR Title 47 Part 15 Subpart C Section 15.247  
**Date of sample receipt:** May 31, 2023  
**Date of Test:** June 01, 2023-July 06, 2023  
**Date of report issued:** July 06, 2023  
**Test Result :** PASS \*

\* In the configuration tested, the EUT complied with the standards specified above.

Authorized Signature:



**Robinson Luo**  
**Laboratory Manager**

## 2 Version

Version No.	Date	Description
00	July 06, 2023	Original

**Prepared By:**

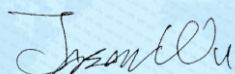

**Date:**

July 06, 2023

**Project Engineer**

**Check By:**

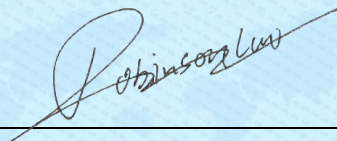

**Date:**

July 06, 2023

**Reviewer**

## 3 Contents

Page

1	COVER PAGE .....	1
2	VERSION .....	2
3	CONTENTS .....	3
4	TEST SUMMARY .....	4
4.1	MEASUREMENT UNCERTAINTY .....	4
5	GENERAL INFORMATION .....	5
5.1	GENERAL DESCRIPTION OF EUT .....	5
5.2	TEST MODE .....	7
5.3	TEST FACILITY.....	7
5.4	TEST LOCATION .....	7
5.5	DESCRIPTION OF SUPPORT UNITS .....	7
5.6	DEVIATION FROM STANDARDS.....	7
5.7	ABNORMALITIES FROM STANDARD CONDITIONS .....	7
5.8	ADDITIONAL INSTRUCTIONS.....	7
6	TEST INSTRUMENTS LIST .....	8
7	TEST RESULTS AND MEASUREMENT DATA.....	10
7.1	ANTENNA REQUIREMENT .....	10
7.2	CONDUCTED EMISSIONS .....	11
7.3	CONDUCTED PEAK OUTPUT POWER .....	14
7.4	20dB EMISSION BANDWIDTH .....	15
7.5	CARRIER FREQUENCIES SEPARATION.....	16
7.6	HOPPING CHANNEL NUMBER .....	17
7.7	DWELL TIME.....	18
7.8	SPURIOUS EMISSION IN NON-RESTRICTED & RESTRICTED BANDS .....	19
7.8.1	Conducted Emission Method.....	19
7.8.2	Radiated Emission Method.....	20
8	TEST SETUP PHOTO .....	42
9	EUT CONSTRUCTIONAL DETAILS .....	42



## 4 Test Summary

Test Item	Section	Result
Antenna Requirement	15.203/15.247 (c)	Pass
AC Power Line Conducted Emission	15.207	Pass
Conducted Peak Output Power	15.247 (b)(1)	Pass
20dB Occupied Bandwidth	15.247 (a)(1)	Pass
Carrier Frequencies Separation	15.247 (a)(1)	Pass
Hopping Channel Number	15.247 (a)(1)(iii)	Pass
Dwell Time	15.247 (a)(1)(iii)	Pass
Radiated Emission	15.205/15.209	Pass
Band Edge	15.247(d)	Pass

*Pass: The EUT complies with the essential requirements in the standard.*

*Remark : Test according to ANSI C63.10:2013 .*

### 4.1 Measurement Uncertainty

Test Item	Frequency Range	Measurement Uncertainty	Notes
Radiated Emission	9kHz-30MHz	3.1dB	(1)
Radiated Emission	30MHz-200MHz	3.8039dB	(1)
Radiated Emission	200MHz-1GHz	3.9679dB	(1)
Radiated Emission	1GHz-18GHz	4.29dB	(1)
Radiated Emission	18GHz-40GHz	3.30dB	(1)
AC Power Line Conducted Emission	0.15MHz ~ 30MHz	3.44dB	(1)

Note (1): The measurement uncertainty is for coverage factor of k=2 and a level of confidence of 95%.

## 5 General Information

### 5.1 General Description of EUT

Product Name:	4-CHANNEL RECEIVER
Model No.:	FGr4D
Serial No.:	RD1001472
Test sample(s) ID:	GTS2023050573-1
Sample(s) Status	Engineer sample
Operation Frequency:	2402.6MHz~2479.4MHz
Channel numbers:	43
Modulation method:	FHSS
Modulation technology:	GMSK
Antenna Type:	ANT 1&2: 2.4G black PCB built-in antenna
Antenna gain:	ANT 1&2: 2.87dBi
Power supply:	DC 3.5-9V

Remark: The system works in the frequency range of 2402.6MHz to 2479.4MHz. This band has been divided to 43 independent channels. Each radio system uses 32 different channels; the minimum channel separation is  $\geq 1.2$ MHz. By using various switch-on times, hopping scheme and channel frequencies, the system can guarantee a jamming free radio transmission. Pre-testing all radio systems, this radio system recorded in the report is the worst mode. The channel list is below.

The test frequencies are below:

Channel	Frequency
The lowest channel	2402.6MHz
The middle channel	2440.4MHz
The Highest channel	2479.4MHz

Operation Frequency each of channel							
Channel	Frequency (MHz)	Channel	Frequency (MHz)	Channel	Frequency (MHz)	Channel	Frequency (MHz)
1	2402.6	12	2422.4	23	2442.2	34	2463.2
2	2404.4	13	2424.2	24	2445.2	35	2465
3	2406.2	14	2426	25	2447	36	2466.8
4	2408	15	2427.8	26	2448.8	37	2468.6
5	2409.8	16	2429.6	27	2450.6	38	2470.4
6	2411.6	17	2431.4	28	2452.4	39	2472.2
7	2413.4	18	2433.2	29	2454.2	40	2474
8	2415.2	19	2435	30	2456	41	2475.8
9	2417	20	2436.8	31	2457.8	42	2477.6
10	2418.8	21	2438.6	32	2459.6	43	2479.4
11	2420.6	22	2440.4	33	2461.4		



## 5.2 Test mode

Transmitting mode	Keep the EUT in transmitting mode.
Remark: During the test, the duty cycle >98%, the test voltage is adjusted from DC3.5V to DC9.0V, and found that the worst case was DC9.0V. So the report just shows that condition's data.	

## 5.3 Test Facility

<p>The test facility is recognized, certified, or accredited by the following organizations:</p> <ul style="list-style-type: none"> <li>● <b>FCC —Registration No.: 381383</b> Designation Number: CN5029 Global United Technology Services Co., Ltd., Shenzhen EMC Laboratory has been registered and fully described in a report filed with the (FCC) Federal Communications Commission. The acceptance letter from the FCC is maintained in files.</li> <li>● <b>IC —Registration No.: 9079A</b> CAB identifier: CN0091 The 3m Semi-anechoic chamber of Global United Technology Services Co., Ltd. has been registered by Certification and Engineering Bureau of Industry Canada for radio equipment testing.</li> <li>● <b>NVLAP (LAB CODE:600179-0)</b> Global United Technology Services Co., Ltd., is accredited by the National Voluntary Laboratory Accreditation Program (NVLAP).</li> </ul>
--

## 5.4 Test Location

All other tests were performed at:
<p>Global United Technology Services Co., Ltd. Address: No. 123-128, Tower A, Jinyuan Business Building, No.2, Laodong Industrial Zone, Xixiang Road, Baoan District, Shenzhen, Guangdong, China 518102 Tel: 0755-27798480 Fax: 0755-27798960</p>

## 5.5 Description of Support Units

Manufacturer	Description	Model	Serial Number
ShenZhen FLYSKY Technology Co.,Ltd	Remote control	FG4	N/A
GW	DC POWER SUPPLY	GPR-6030D	EF924756

## 5.6 Deviation from Standards

None.
-------

## 5.7 Abnormalities from Standard Conditions

None.
-------

## 5.8 Additional Instructions

Software (Used for test) from client
Built-in by manufacturer, power set default.

## 6 Test Instruments list

Radiated Emission:						
Item	Test Equipment	Manufacturer	Model No.	Inventory No.	Cal.Date (mm-dd-yy)	Cal.Due date (mm-dd-yy)
1	3m Semi- Anechoic Chamber	ZhongYu Electron	9.2(L)*6.2(W)* 6.4(H)	GTS250	June 23, 2021	June 22, 2024
2	Control Room	ZhongYu Electron	6.2(L)*2.5(W)* 2.4(H)	GTS251	N/A	N/A
3	EMI Test Receiver	Rohde & Schwarz	ESU26	GTS203	April 14, 2023	April 13, 2024
4	BiConiLog Antenna	SCHWARZBECK MESS-ELEKTRONIK	VULB9168	GTS640	March 19, 2023	March 18, 2025
5	Double -ridged waveguide horn	SCHWARZBECK MESS-ELEKTRONIK	BBHA 9120 D	GTS208	April 17, 2023	April 16, 2025
6	EMI Test Software	AUDIX	E3	N/A	N/A	N/A
7	Coaxial Cable	GTS	N/A	GTS213	April 21, 2023	April 20, 2024
8	Coaxial Cable	GTS	N/A	GTS211	April 21, 2023	April 20, 2024
9	Coaxial cable	GTS	N/A	GTS210	April 21, 2023	April 20, 2024
10	Coaxial Cable	GTS	N/A	GTS212	April 21, 2023	April 20, 2024
11	Wideband Radio Communication Tester	Rohde & Schwarz	CMW500	GTS575	April 14, 2023	April 13, 2024
12	Loop Antenna	ZHINAN	ZN30900A	GTS534	Nov. 29, 2022	Nov. 28, 2023
13	Broadband Preamplifier	SCHWARZBECK	BBV9718	GTS535	April 14, 2023	April 13, 2024
14	Amplifier(1GHz-26.5GHz)	HP	8449B	GTS601	April 14, 2023	April 13, 2024
15	Horn Antenna (18-26.5GHz)	/	UG-598A/U	GTS664	Oct. 30, 2022	Oct. 29, 2023
16	Horn Antenna (26.5-40GHz)	A.H Systems	SAS-573	GTS665	Oct. 30, 2022	Oct. 29, 2023
17	FSV·Signal Analyzer (10Hz-40GHz)	Keysight	FSV-40-N	GTS666	March 13, 2023	March 12, 2024
18	Amplifier	/	LNA-1000-30S	GTS650	April 14, 2023	April 13, 2024
19	CDNE M2+M3-16A	HCT	30MHz-300MHz	GTS668	Dec. 20, 2022	Dec.19, 2023
20	Thermo meter	JINCHUANG	GSP-8A	GTS643	April 19, 2023	April 18, 2024



Conducted Emission						
Item	Test Equipment	Manufacturer	Model No.	Inventory No.	Cal.Date (mm-dd-yy)	Cal.Due date (mm-dd-yy)
1	Shielding Room	ZhongYu Electron	7.3(L)x3.1(W)x2.9(H)	GTS252	July 12, 2022	July 11, 2027
2	EMI Test Receiver	R&S	ESCI 7	GTS552	April 14, 2023	April 13, 2024
3	LISN	ROHDE & SCHWARZ	ENV216	GTS226	April 14, 2023	April 13, 2024
4	Coaxial Cable	GTS	N/A	GTS227	N/A	N/A
5	EMI Test Software	AUDIX	E3	N/A	N/A	N/A
6	Thermo meter	JINCHUANG	GSP-8A	GTS642	April 19, 2023	April 18, 2024
7	Absorbing clamp	Elektronik-Feinmechanik	MDS21	GTS229	April 14, 2023	April 13, 2024
8	ISN	SCHWARZBECK	NTFM 8158	GTS565	April 14, 2023	April 13, 2024
9	High voltage probe	SCHWARZBECK	TK9420	GTS537	April 14, 2023	April 13, 2024
10	Antenna end assembly	Weinschel	1870A	GTS560	April 14, 2023	April 13, 2024

RF Conducted Test:						
Item	Test Equipment	Manufacturer	Model No.	Serial No.	Cal.Date (mm-dd-yy)	Cal.Due date (mm-dd-yy)
1	MXA Signal Analyzer	Agilent	N9020A	GTS566	April 14, 2023	April 13, 2024
2	EMI Test Receiver	R&S	ESCI 7	GTS552	April 14, 2023	April 13, 2024
3	PSA Series Spectrum Analyzer	Agilent	E4440A	GTS536	April 14, 2023	April 13, 2024
4	MXG vector Signal Generator	Agilent	N5182A	GTS567	April 14, 2023	April 13, 2024
5	ESG Analog Signal Generator	Agilent	E4428C	GTS568	April 14, 2023	April 13, 2024
6	USB RF Power Sensor	DARE	RPR3006W	GTS569	April 14, 2023	April 13, 2024
7	RF Switch Box	Shongyi	RFSW3003328	GTS571	April 14, 2023	April 13, 2024
8	Programmable Constant Temp & Humi Test Chamber	WEWON	WHTH-150L-40-880	GTS572	April 14, 2023	April 13, 2024
9	Thermo meter	JINCHUANG	GSP-8A	GTS641	April 19, 2023	April 18, 2024
10	EXA Signal Analyzer	Keysight	N9010B	MY60241168	Nov. 04, 2022	Nov. 03, 2023

General used equipment:						
Item	Test Equipment	Manufacturer	Model No.	Inventory No.	Cal.Date (mm-dd-yy)	Cal.Due date (mm-dd-yy)
1	Barometer	KUMAO	SF132	GTS647	April 19, 2023	April 18, 2024

## 7 Test results and Measurement Data

### 7.1 Antenna requirement

<b>Standard requirement:</b>	FCC Part15 C Section 15.203 /247(c)
<p><b>15.203 requirement:</b></p> <p>An intentional radiator shall be designed to ensure that no antenna other than that furnished by the responsible party shall be used with the device. The use of a permanently attached antenna or of an antenna that uses a unique coupling to the intentional radiator, the manufacturer may design the unit so that a broken antenna can be replaced by the user, but the use of a standard antenna jack or electrical connector is prohibited.</p> <p><b>15.247(c) (1)(i) requirement:</b></p> <p>(i) Systems operating in the 2400-2483.5 MHz band that is used exclusively for fixed. Point-to-point operations may employ transmitting antennas with directional gain greater than 6dBi provided the maximum conducted output power of the intentional radiator is reduced by 1 dB for every 3 dB that the directional gain of the antenna exceeds 6dBi.</p>	
<b>EUT Antenna:</b>	
The antenna is 2.4G black PCB built-in antenna, reference to the appendix II for details.	

## 7.2 Conducted Emissions

Test Requirement:	FCC Part15 C Section 15.207					
Test Method:	ANSI C63.10:2013					
Test Frequency Range:	150KHz to 30MHz					
Receiver setup:	RBW=9KHz, VBW=30KHz, Sweep time=auto					
Limit:	Frequency range (MHz)		Limit (dBuV)			
			Quasi-peak		Average	
	0.15-0.5		66 to 56*		56 to 46*	
	0.5-5		56		46	
	5-30		60		50	
* Decreases with the logarithm of the frequency.						
Test setup:	<p><i>Remark:</i>                      E.U.T.: Equipment Under Test                      LISN: Line Impedance Stabilization Network                      Test table height=0.8m</p>					
Test procedure:	<ol style="list-style-type: none"> <li>1. The E.U.T and simulators are connected to the main power through a line impedance stabilization network (L.I.S.N.). This provides a 50ohm/50uH coupling impedance for the measuring equipment.</li> <li>2. The peripheral devices are also connected to the main power through a LISN that provides a 50ohm/50uH coupling impedance with 50ohm termination. (Please refer to the block diagram of the test setup and photographs).</li> <li>3. Both sides of A.C. line are checked for maximum conducted interference. In order to find the maximum emission, the relative positions of equipment and all of the interface cables must be changed according to ANSI C63.10:2013 :2009 on conducted measurement.</li> </ol>					
Test Instruments:	Refer to section 6.0 for details					
Test mode:	Refer to section 5.2 for details					
Test environment:	Temp.:	25 °C	Humid.:	52%	Press.:	1012mbar
Test results:	Pass					



## Measurement data

Pre-scan all test modes, found worst case at 2402.6MHz@Ant 1, and so only show the test result of it.

Line:

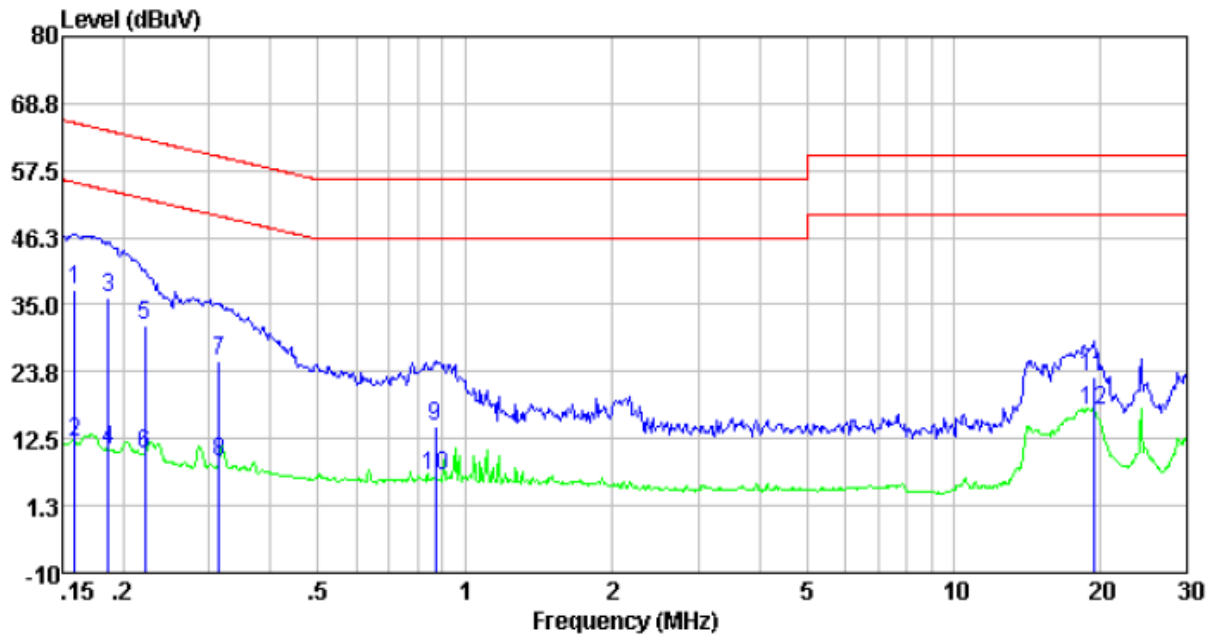

Freq	Reading level	LISN/ISN factor	Cable loss	Level	Limit level	Over limit	Remark
MHz	dBuV	dB	dB	dBuV	dBuV	dB	
0.16	27.40	10.11	0.01	37.52	65.52	-28.00	QP
0.16	1.67	10.11	0.01	11.79	55.52	-43.73	Average
0.19	26.16	10.07	0.01	36.24	64.20	-27.96	QP
0.19	0.56	10.07	0.01	10.64	54.20	-43.56	Average
0.22	21.52	10.03	0.01	31.56	62.79	-31.23	QP
0.22	-0.23	10.03	0.01	9.81	52.79	-42.98	Average
0.31	15.48	9.98	0.01	25.47	59.88	-34.41	QP
0.31	-1.48	9.98	0.01	8.51	49.88	-41.37	Average
0.87	4.60	9.96	0.03	14.59	56.00	-41.41	QP
0.87	-3.86	9.96	0.03	6.13	46.00	-39.87	Average
19.33	13.10	9.44	0.18	22.72	60.00	-37.28	QP
19.33	7.55	9.44	0.18	17.17	50.00	-32.83	Average

Neutral:

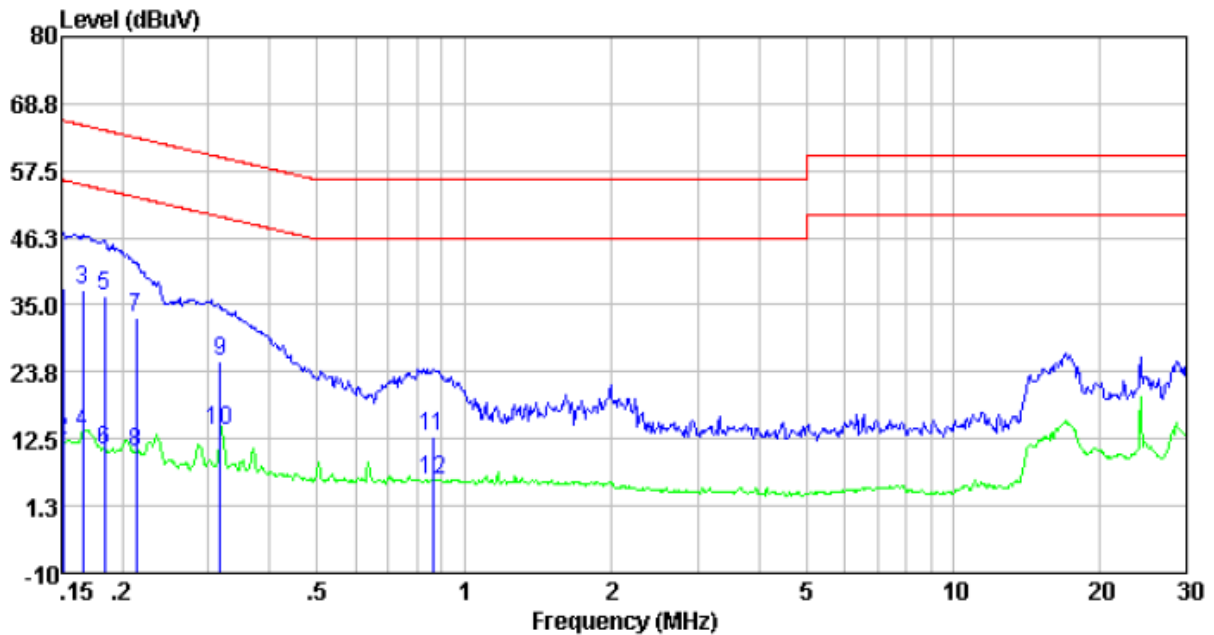

Freq	Reading level	LISN/ISN factor	Cable loss	Level	Limit level	Over limit	Remark
MHz	dBuV	dB	dB	dBuV	dBuV	dB	
0.15	27.61	10.16	0.01	37.78	65.96	-28.18	QP
0.15	1.95	10.16	0.01	12.12	55.96	-43.84	Average
0.17	27.29	10.13	0.01	37.43	65.16	-27.73	QP
0.17	3.33	10.13	0.01	13.47	55.16	-41.69	Average
0.18	26.26	10.09	0.01	36.36	64.33	-27.97	QP
0.18	0.57	10.09	0.01	10.67	54.33	-43.66	Average
0.21	22.63	10.05	0.01	32.69	63.10	-30.41	QP
0.21	0.22	10.05	0.01	10.28	53.10	-42.82	Average
0.32	15.53	9.97	0.01	25.51	59.80	-34.29	QP
0.32	4.09	9.97	0.01	14.07	49.80	-35.73	Average
0.86	3.08	9.96	0.03	13.07	56.00	-42.93	QP
0.86	-4.46	9.96	0.03	5.53	46.00	-40.47	Average

Notes:

1. An initial pre-scan was performed on the line and neutral lines with peak detector.
2. Quasi-Peak and Average measurement were performed at the frequencies with maximized peak emission.
3. Final Level = Receiver Read level + LISN Factor + Cable Loss
4. If the average limit is met when using a quasi-peak detector receiver, the EUT shall be deemed to meet both limits and measurement with the average detector receiver is unnecessary.

## 7.3 Conducted Peak Output Power

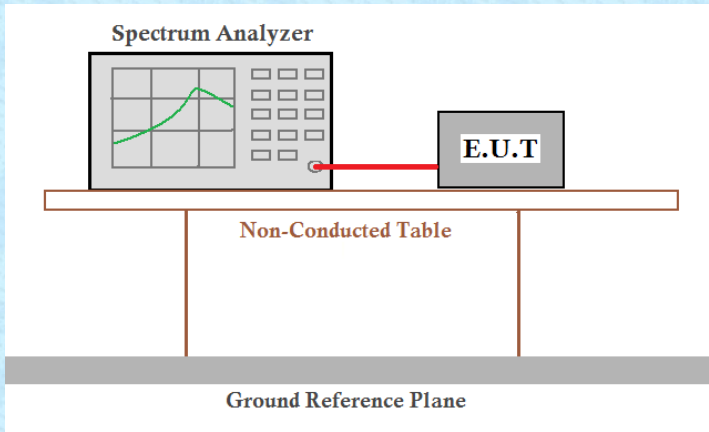
Test Requirement:	FCC Part15 C Section 15.247(a)(1)
Test Method:	ANSI C63.10:2013
Limit:	20.97dBm
Test setup:	 <p>The diagram illustrates the test setup. A Spectrum Analyzer is connected to an E.U.T. (Equipment Under Test) via a red cable. Both are placed on a Non-Conducted Table, which sits on a Ground Reference Plane.</p>
Test Instruments:	Refer to section 6.0 for details
Test mode:	Refer to section 5.2 for details
Test results:	Pass

**Measurement Data:** The detailed test data see Appendix for 2.4G.

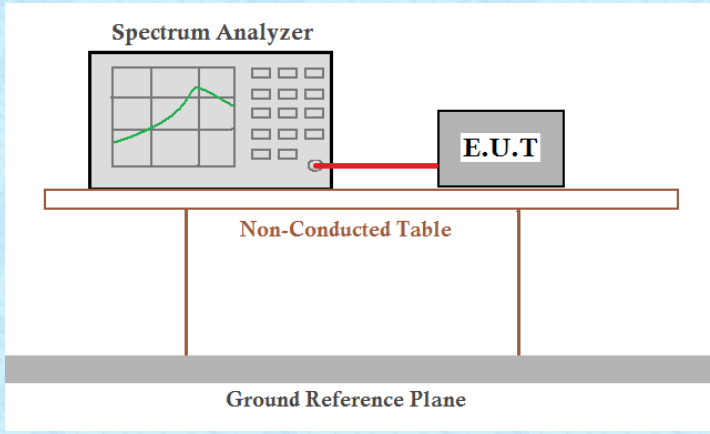

## 7.4 20dB Emission Bandwidth

Test Requirement:	FCC Part15 C Section 15.247 (a)(1)
Test Method:	ANSI C63.10:2013
Limit:	N/A
Test setup:	 <p>The diagram illustrates the test setup. A Spectrum Analyzer is connected to an E.U.T. (Equipment Under Test) via a red cable. Both are placed on a Non-Conducted Table, which is supported by a Ground Reference Plane.</p>
Test Instruments:	Refer to section 6.0 for details
Test mode:	Refer to section 5.2 for details
Test results:	Pass

**Measurement Data:** The detailed test data see Appendix for 2.4G.

## 7.5 Carrier Frequencies Separation

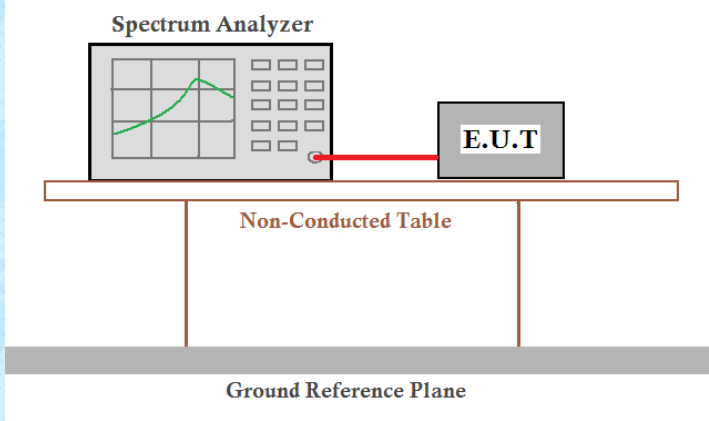
Test Requirement:	FCC Part15 C Section 15.247 (a)(1)
Test Method:	ANSI C63.10:2013
Receiver setup:	RBW=300KHz, VBW=300KHz, detector=Peak
Limit:	0.025MHz or 2/3 of the 20dB bandwidth (whichever is greater)
Test setup:	 <p>The diagram illustrates the test setup. A Spectrum Analyzer is connected to an E.U.T. (Equipment Under Test) via a red cable. Both are placed on a Non-Conducted Table, which is supported by a Ground Reference Plane.</p>
Test Instruments:	Refer to section 6.0 for details
Test mode:	Refer to section 5.2 for details
Test results:	Pass

**Measurement Data:** The detailed test data see Appendix for 2.4G.

## 7.6 Hopping Channel Number

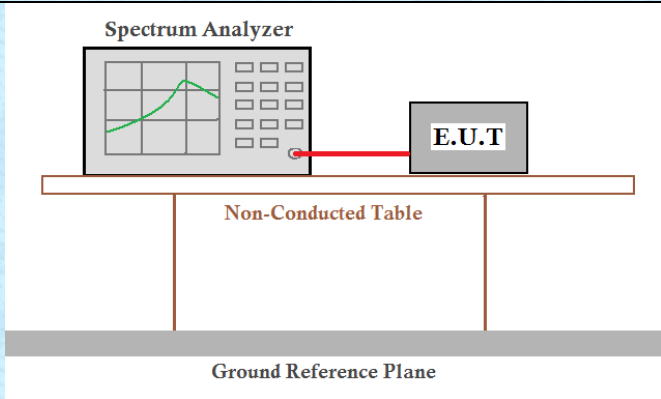
Test Requirement:	FCC Part15 C Section 15.247 (a)(1)(iii)
Test Method:	ANSI C63.10:2013
Receiver setup:	RBW=300kHz, VBW=300kHz, Frequency range=2400MHz-2483.5MHz, Detector=Peak
Limit:	15 channels
Test setup:	 <p>The diagram illustrates the test setup. A Spectrum Analyzer is connected to an E.U.T. (Equipment Under Test) via a red cable. Both are placed on a Non-Conducted Table, which sits on a Ground Reference Plane.</p>
Test Instruments:	Refer to section 6.0 for details
Test mode:	Refer to section 5.2 for details
Test results:	Pass

**Measurement Data:** The detailed test data see Appendix for 2.4G.

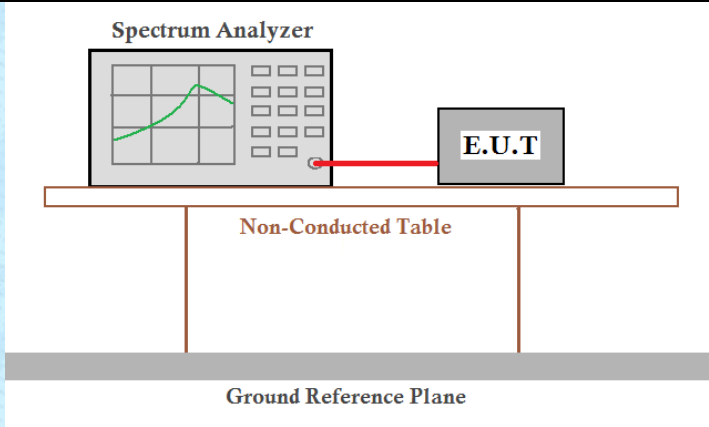

## 7.7 Dwell Time

Test Requirement:	FCC Part15 C Section 15.247 (a)(1)(iii)
Test Method:	ANSI C63.10:2013
Receiver setup:	RBW=300KHz, VBW=300KHz, Span=0Hz, Detector=Peak
Limit:	0.4 Second
Test setup:	 <p>The diagram illustrates the test setup. A Spectrum Analyzer is connected to an E.U.T. (Equipment Under Test) via a red cable. Both are placed on a Non-Conducted Table, which is supported by a Ground Reference Plane.</p>
Test Instruments:	Refer to section 6.0 for details
Test mode:	Refer to section 5.2 for details
Test results:	Pass

**Measurement Data:** The detailed test data see Appendix for 2.4G.

## 7.8 Spurious Emission in Non-restricted & restricted Bands

### 7.8.1 Conducted Emission Method

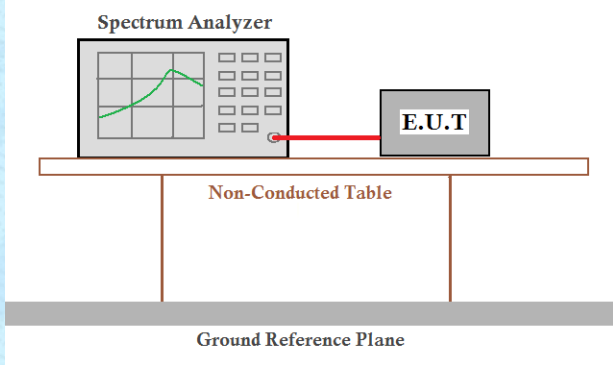
Test Requirement:	FCC Part15 C Section 15.247 (d)
Test Method:	ANSI C63.10:2013
Receiver setup:	RBW=100kHz, VBW=300kHz, Detector=Peak
Limit:	In any 100 kHz bandwidth outside the frequency band in which the spread spectrum intentional radiator is operating, the radio frequency power that is produced by the intentional radiator shall be at least 20 dB below that in the 100 kHz bandwidth within the band that contains the highest level of the desired power, based on either an RF conducted or a radiated measurement.
Test setup:	 <p>The diagram illustrates the test setup. A Spectrum Analyzer is connected to an E.U.T. (Equipment Under Test) via a red cable. Both are placed on a Non-Conducted Table, which sits on a Ground Reference Plane.</p>
Test Instruments:	Refer to section6.0 for details
Test mode:	Refer to section 5.2 for details
Test results:	Pass

**Measurement Data:** The detailed test data see Appendix for 2.4G.

## 7.8.2 Radiated Emission Method

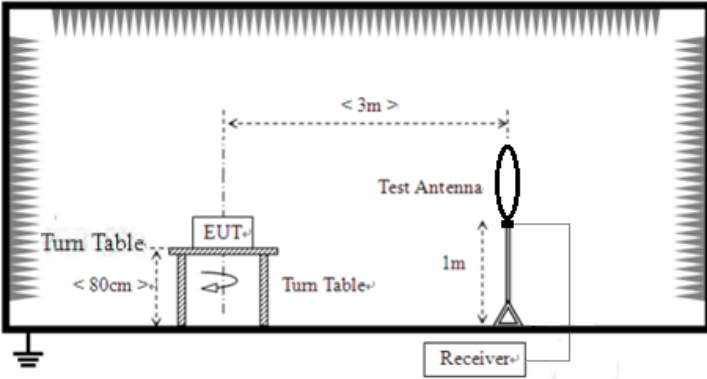
Test Requirement:	FCC Part15 C Section 15.209 and 15.205				
Test Method:	ANSI C63.10:2013				
Test Frequency Range:	9kHz to 25GHz				
Test site:	Measurement Distance: 3m				
Receiver setup:	Frequency	Detector	RBW	VBW	Value
	9KHz-150KHz	Quasi-peak	200Hz	600Hz	Quasi-peak
	150KHz-30MHz	Quasi-peak	9KHz	30KHz	Quasi-peak
	30MHz-1GHz	Quasi-peak	120KHz	300KHz	Quasi-peak
	Above 1GHz	Peak	1MHz	3MHz	Peak
Peak		1MHz	10Hz	Average	
Limit: (Spurious Emissions)	Frequency	Limit (uV/m)	Value	Measurement Distance	
	0.009MHz-0.490MHz	2400/F(KHz)	QP	300m	
	0.490MHz-1.705MHz	24000/F(KHz)	QP	300m	
	1.705MHz-30MHz	30	QP	30m	
	30MHz-88MHz	100	QP	3m	
	88MHz-216MHz	150	QP		
	216MHz-960MHz	200	QP		
	960MHz-1GHz	500	QP		
	Above 1GHz	500	Average		
5000		Peak			
Test setup:	Below 30MHz				
	 <p>Below 1GHz</p>				

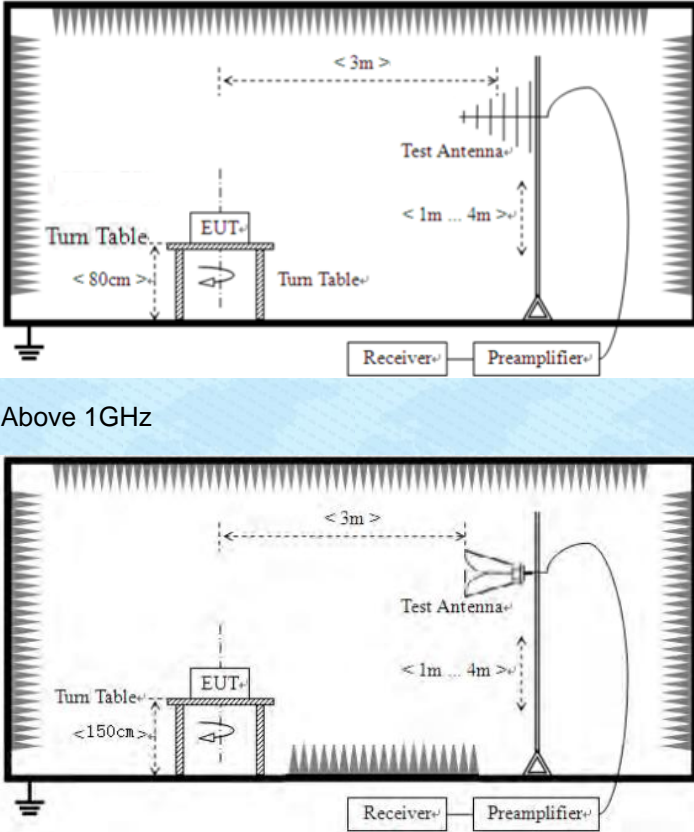

	 <p>Above 1GHz</p>						
<p>Test Procedure:</p>	<ol style="list-style-type: none"> <li>1. The EUT was placed on the top of a rotating table (0.8 meters for below 1GHz and 1.5meters for above 1GHz) above the ground at a 3 meter camber. The table was rotated 360 degrees to determine the position of the highest radiation.</li> <li>2. The EUT was set 3 meters away from the interference-receiving antenna, which was mounted on the top of a variable-height antenna tower.</li> <li>3. The antenna height is varied from one meter to four meters above the ground to determine the maximum value of the field strength. Both horizontal and vertical polarizations of the antenna are set to make the measurement.</li> <li>4. For each suspected emission, the EUT was arranged to its worst case and then the antenna was tuned to heights from 1 meter to 4 meters and the rota table was turned from 0 degrees to 360 degrees to find the maximum reading.</li> <li>5. The test-receiver system was set to Peak Detect Function and Specified Bandwidth with Maximum Hold Mode.</li> <li>6. If the emission level of the EUT in peak mode was 10dB lower than the limit specified, then testing could be stopped and the peak values of the EUT would be reported. Otherwise the emissions that did not have 10dB margin would be re-tested one by one using peak, quasi-peak or average method as specified and then reported in a data sheet.</li> </ol>						
<p>Test Instruments:</p>	<p>Refer to section 5.8 for details</p>						
<p>Test mode:</p>	<p>Refer to section 5.2 for details</p>						
<p>Temp. / Hum.</p>	<table border="1"> <tr> <td>Temp.:</td> <td>25 °C</td> <td>Humid.:</td> <td>52%</td> <td>Press.:</td> <td>1 012mbar</td> </tr> </table>	Temp.:	25 °C	Humid.:	52%	Press.:	1 012mbar
Temp.:	25 °C	Humid.:	52%	Press.:	1 012mbar		

Test results:	Pass
---------------	------

**Remark:**

1. Pre-scan all kind of the place mode (X-axis, Y-axis, Z-axis), and found the Y-axis which it is worse case.

**Measurement data:**

■ **Below 30MHz**

The low frequency, which started from 9 kHz to 30 MHz, was pre-scanned and the result which was 20 dB lower than the limit line per 15.31(o) was not reported.

**30MHz ~ 1GHz**

All antennas have test, only the worst case ANT 1 report.

Test channel:	Lowest	Polarization:	Horizontal
---------------	--------	---------------	------------

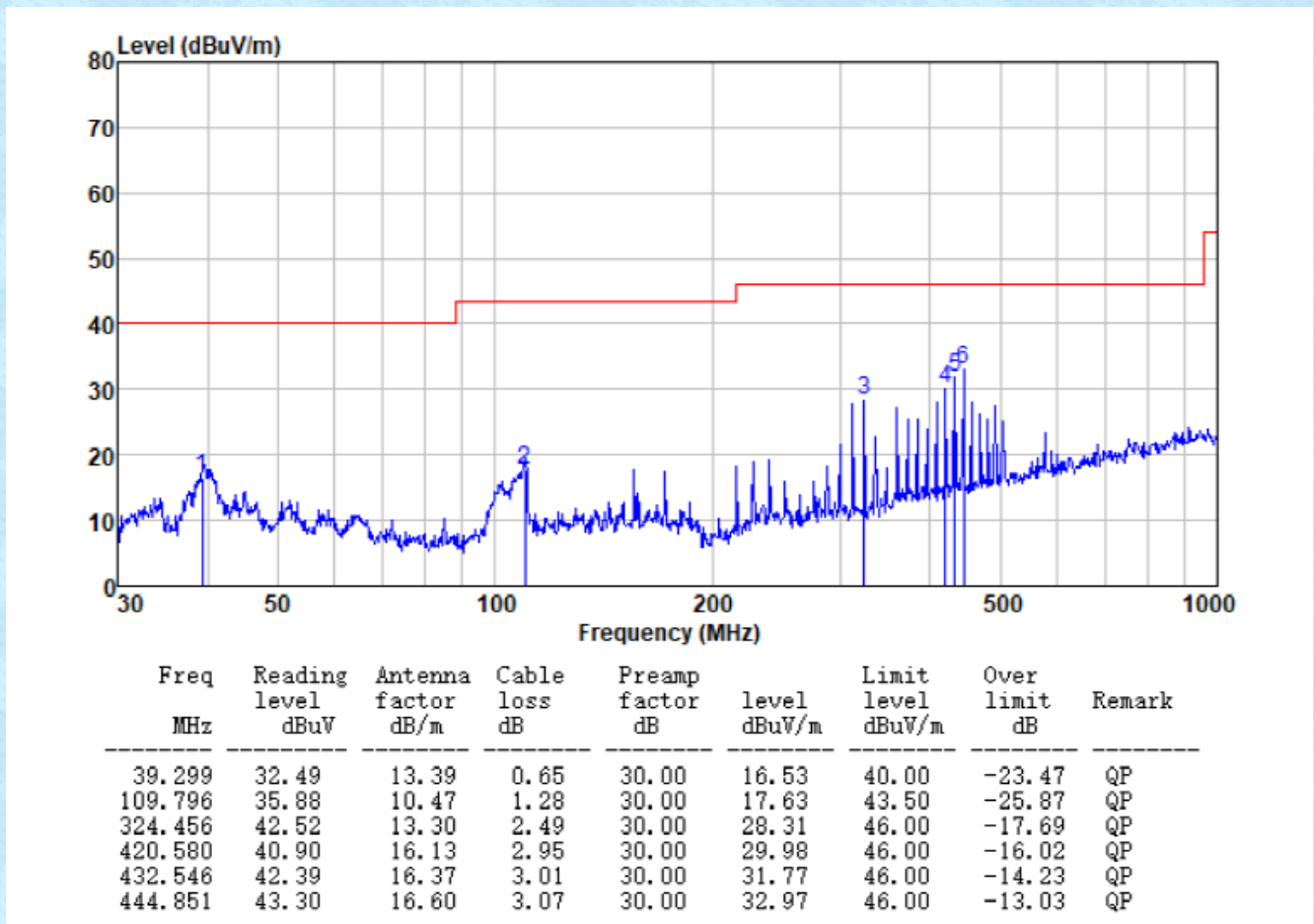

Test channel:	Lowest	Polarization:	Vertical
---------------	--------	---------------	----------

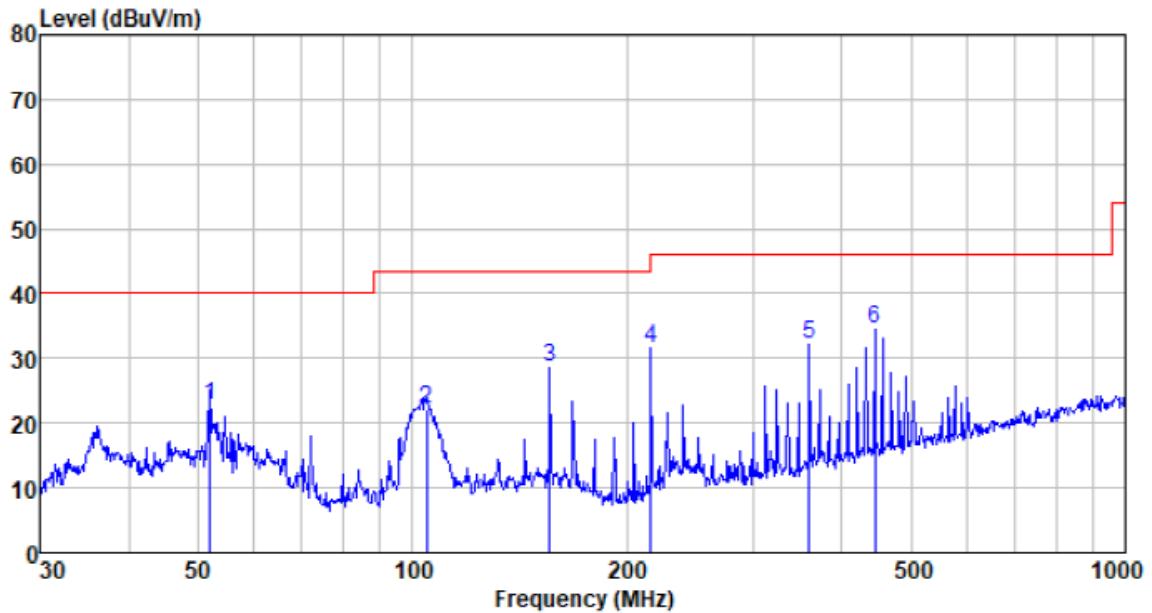

Freq MHz	Reading level dBuV	Antenna factor dB/m	Cable loss dB	Preamp factor dB	level dBuV/m	Limit level dBuV/m	Over limit dB	Remark
52.025	38.88	13.07	0.79	30.00	22.74	40.00	-17.26	QP
104.536	40.76	10.06	1.23	30.00	22.05	43.50	-21.45	QP
155.910	44.40	12.56	1.60	30.00	28.56	43.50	-14.94	QP
216.024	49.59	10.09	1.93	30.00	31.61	46.00	-14.39	QP
360.448	44.95	14.51	2.67	30.00	32.13	46.00	-13.87	QP
444.851	44.90	16.60	3.07	30.00	34.57	46.00	-11.43	QP



Test channel:	Middle	Polarization:	Horizontal
---------------	--------	---------------	------------

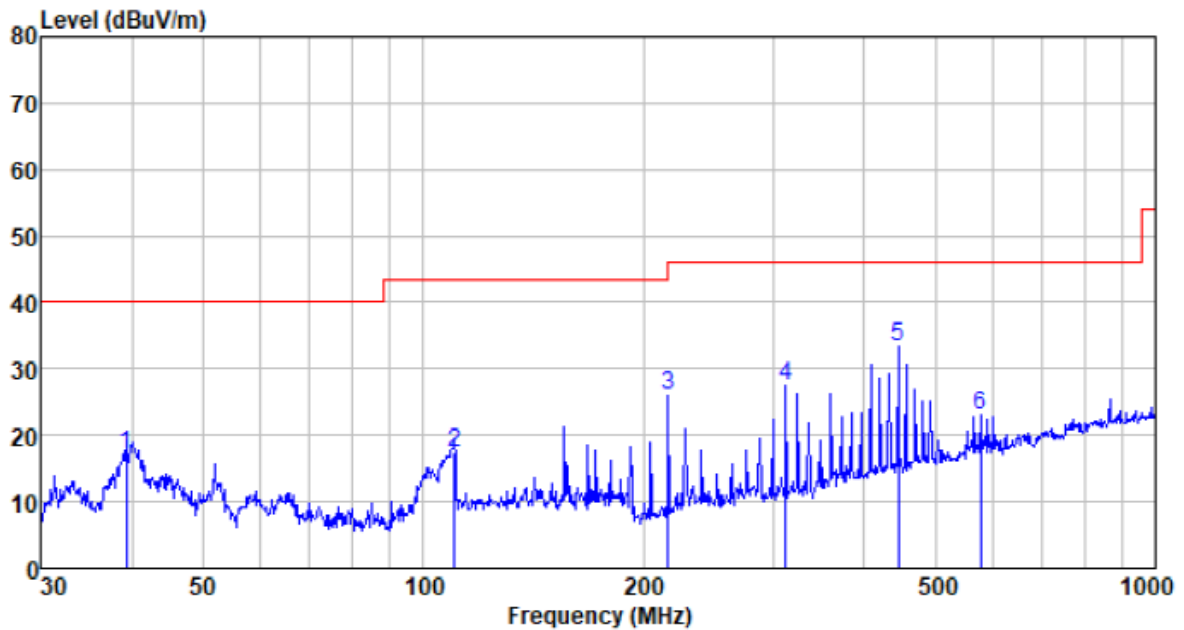

Freq MHz	Reading level dBuV	Antenna factor dB/m	Cable loss dB	Preamp factor dB	level dBuV/m	Limit level dBuV/m	Over limit dB	Remark
39.299	33.13	13.39	0.65	30.00	17.17	40.00	-22.83	QP
110.182	35.64	10.50	1.28	30.00	17.42	43.50	-26.08	QP
216.024	43.91	10.09	1.93	30.00	25.93	46.00	-20.07	QP
312.179	42.23	12.86	2.42	30.00	27.51	46.00	-18.49	QP
444.851	43.73	16.60	3.07	30.00	33.40	46.00	-12.60	QP
576.644	30.52	18.93	3.63	30.00	23.08	46.00	-22.92	QP

Test channel:	Middle	Polarization:	Vertical
---------------	--------	---------------	----------

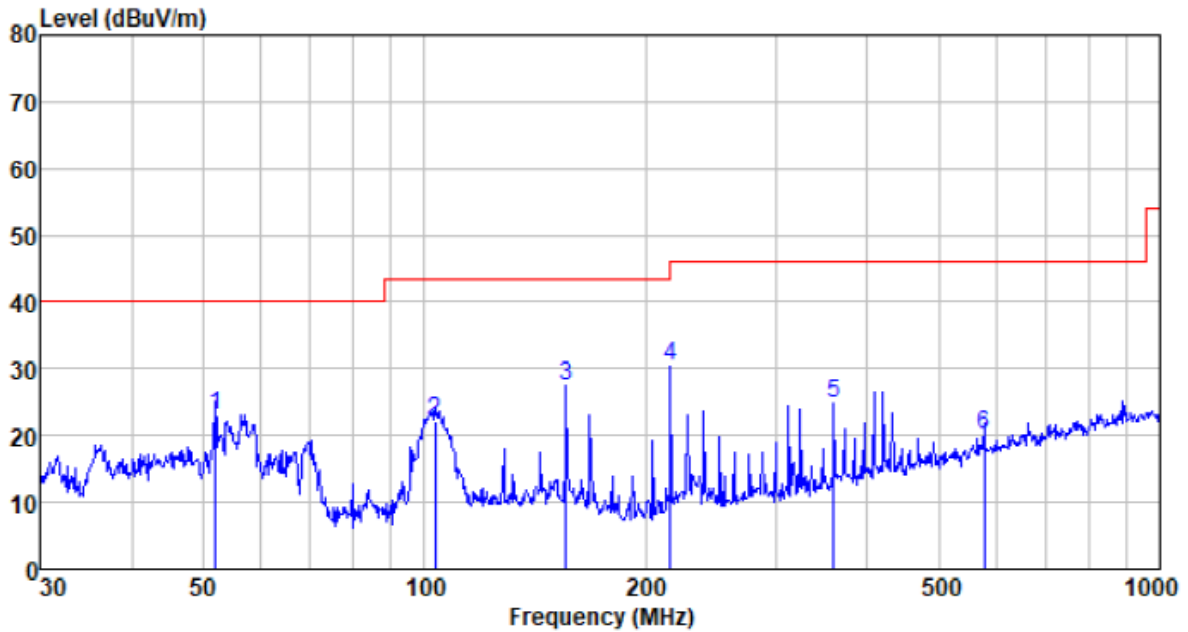

Freq MHz	Reading level dBuV	Antenna factor dB/m	Cable loss dB	Preamp factor dB	level dBuV/m	Limit level dBuV/m	Over limit dB	Remark
52.025	39.31	13.07	0.79	30.00	23.17	40.00	-16.83	QP
103.442	40.95	9.98	1.22	30.00	22.15	43.50	-21.35	QP
155.910	43.40	12.56	1.60	30.00	27.56	43.50	-15.94	QP
216.024	48.43	10.09	1.93	30.00	30.45	46.00	-15.55	QP
360.448	37.53	14.51	2.67	30.00	24.71	46.00	-21.29	QP
576.644	27.40	18.93	3.63	30.00	19.96	46.00	-26.04	QP

Test channel:	Highest	Polarization:	Horizontal
---------------	---------	---------------	------------

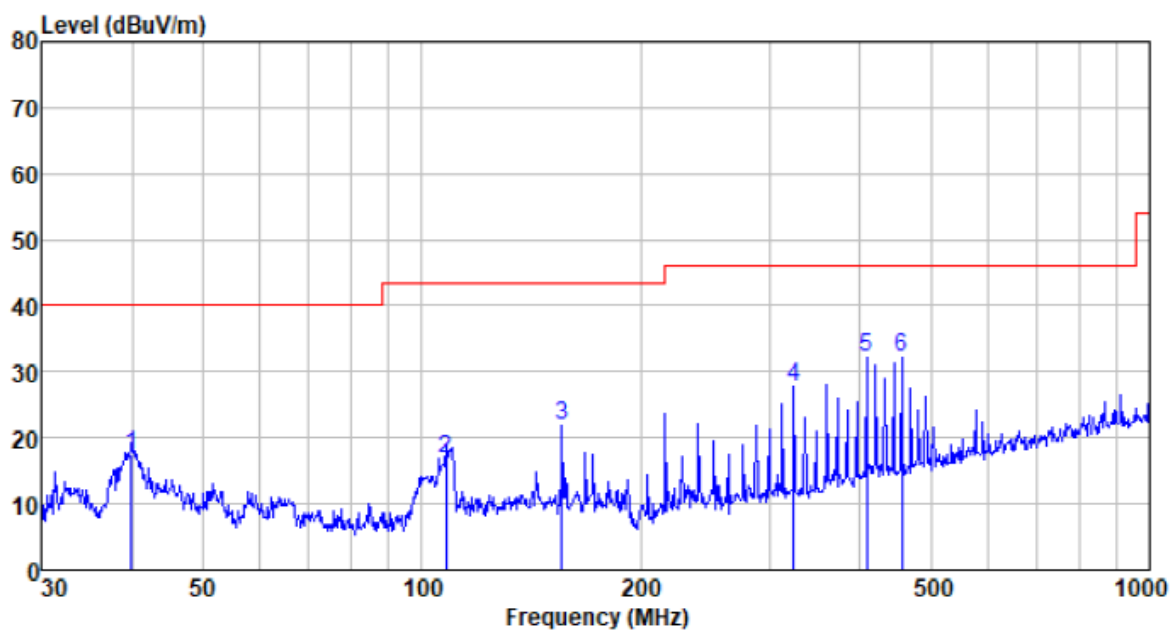

Freq MHz	Reading level dBuV	Antenna factor dB/m	Cable loss dB	Preamp factor dB	level dBuV/m	Limit level dBuV/m	Over limit dB	Remark
39.854	33.15	13.48	0.66	30.00	17.29	40.00	-22.71	QP
107.888	35.21	10.32	1.26	30.00	16.79	43.50	-26.71	QP
155.910	37.72	12.56	1.60	30.00	21.88	43.50	-21.62	QP
324.456	42.10	13.30	2.49	30.00	27.89	46.00	-18.11	QP
408.946	43.29	15.89	2.90	30.00	32.08	46.00	-13.92	QP
455.906	42.25	16.81	3.11	30.00	32.17	46.00	-13.83	QP



Test channel:	Highest	Polarization:	Vertical
---------------	---------	---------------	----------

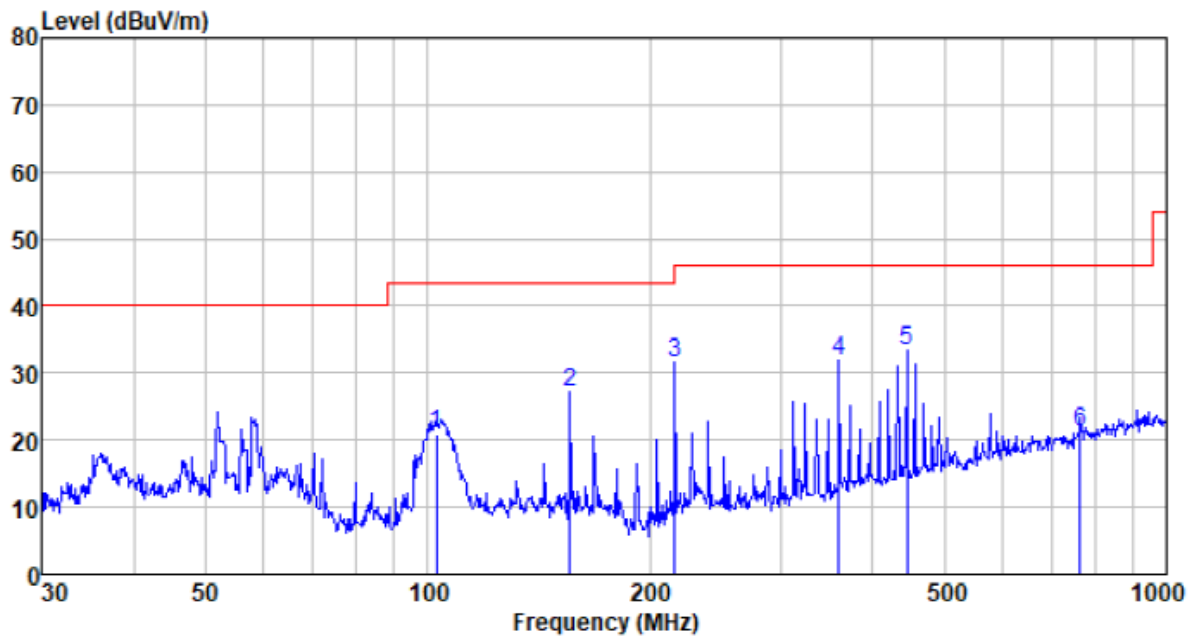

Freq MHz	Reading level dBuV	Antenna factor dB/m	Cable loss dB	Preamp factor dB	level dBuV/m	Limit level dBuV/m	Over limit dB	Remark
102.719	39.94	9.92	1.22	30.00	21.08	43.50	-22.42	QP
155.910	43.01	12.56	1.60	30.00	27.17	43.50	-16.33	QP
216.024	49.54	10.09	1.93	30.00	31.56	46.00	-14.44	QP
360.448	44.67	14.51	2.67	30.00	31.85	46.00	-14.15	QP
444.851	43.57	16.60	3.07	30.00	33.24	46.00	-12.76	QP
763.376	24.87	22.03	4.32	30.00	21.22	46.00	-24.78	QP

- Above 1GHz
- Unwanted Emissions in Non-restricted Frequency Bands
- All antennas have test, only the worst case ANT 1 report.

Test channel:	Lowest	Polarization:	Horizontal
---------------	--------	---------------	------------

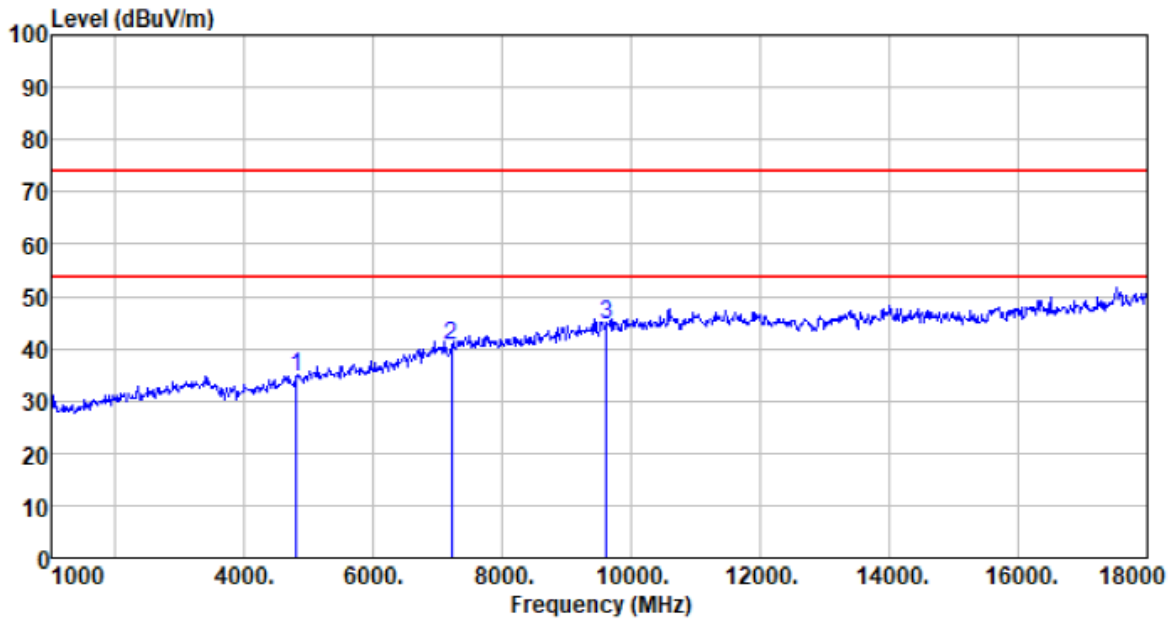

Freq MHz	Reading level dBuV	Antenna factor dB/m	Cable loss dB	Preamp factor dB	level dBuV/m	Limit level dBuV/m	Over limit dB	Remark
4805.200	37.38	31.05	4.61	38.36	34.68	74.00	-39.32	Peak
7207.800	37.25	35.92	6.48	38.96	40.69	74.00	-33.31	Peak
9610.400	38.27	37.91	7.97	39.68	44.47	74.00	-29.53	Peak

Test channel:	Lowest	Polarization:	Vertical
---------------	--------	---------------	----------

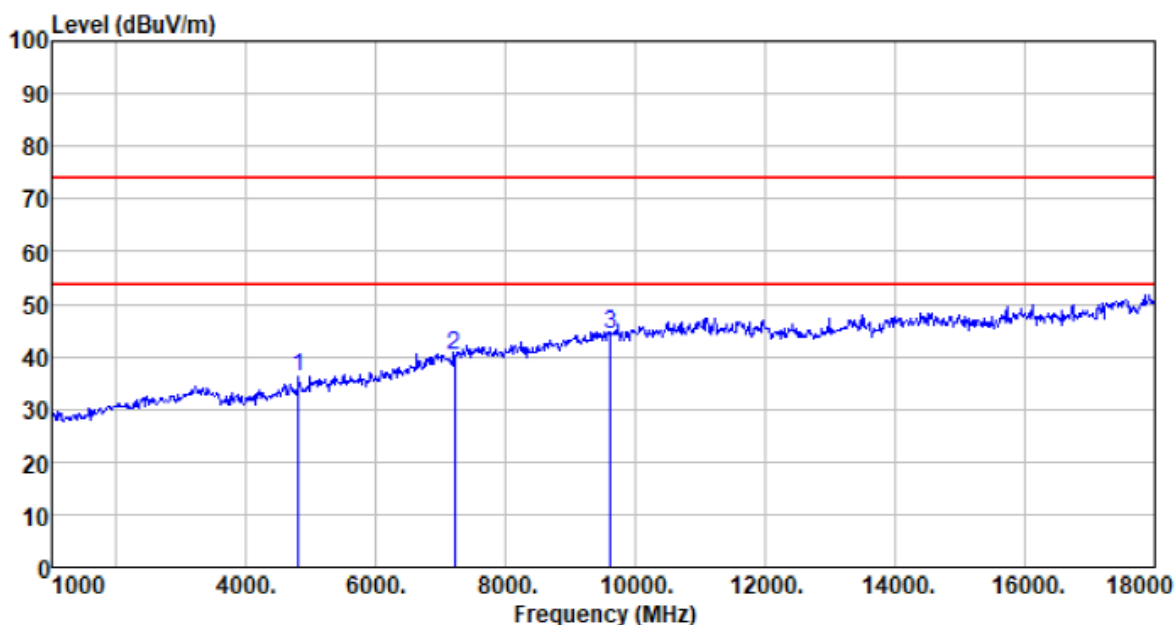

Freq MHz	Reading level dBuV	Antenna factor dB/m	Cable loss dB	Preamp factor dB	level dBuV/m	Limit level dBuV/m	Over limit dB	Remark
4805.200	38.73	31.05	4.61	38.36	36.03	74.00	-37.97	Peak
7207.800	36.66	35.92	6.48	38.96	40.10	74.00	-33.90	Peak
9610.400	37.90	37.91	7.97	39.68	44.10	74.00	-29.90	Peak



Test channel:	Middle	Polarization:	Horizontal
---------------	--------	---------------	------------

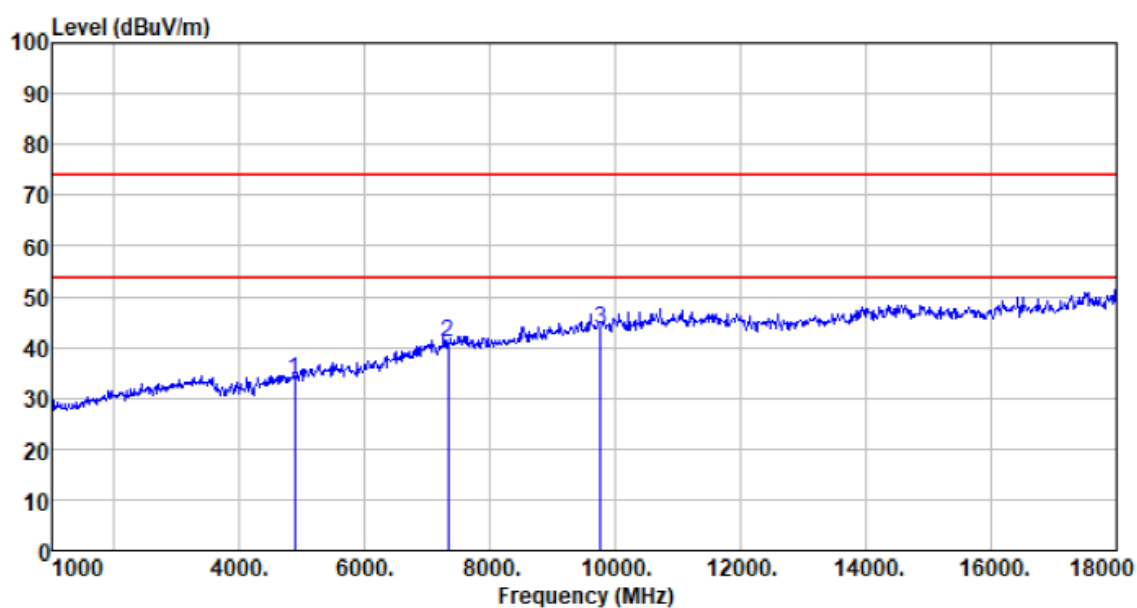

Freq MHz	Reading level dBuV	Antenna factor dB/m	Cable loss dB	Preamp factor dB	level dBuV/m	Limit level dBuV/m	Over limit dB	Remark
4880.800	35.98	31.27	4.69	38.38	33.56	74.00	-40.44	Peak
7321.200	37.11	36.14	6.63	39.00	40.88	74.00	-33.12	Peak
9762.400	37.29	38.06	8.03	39.73	43.65	74.00	-30.35	Peak

Test channel:	Middle	Polarization:	Vertical
---------------	--------	---------------	----------

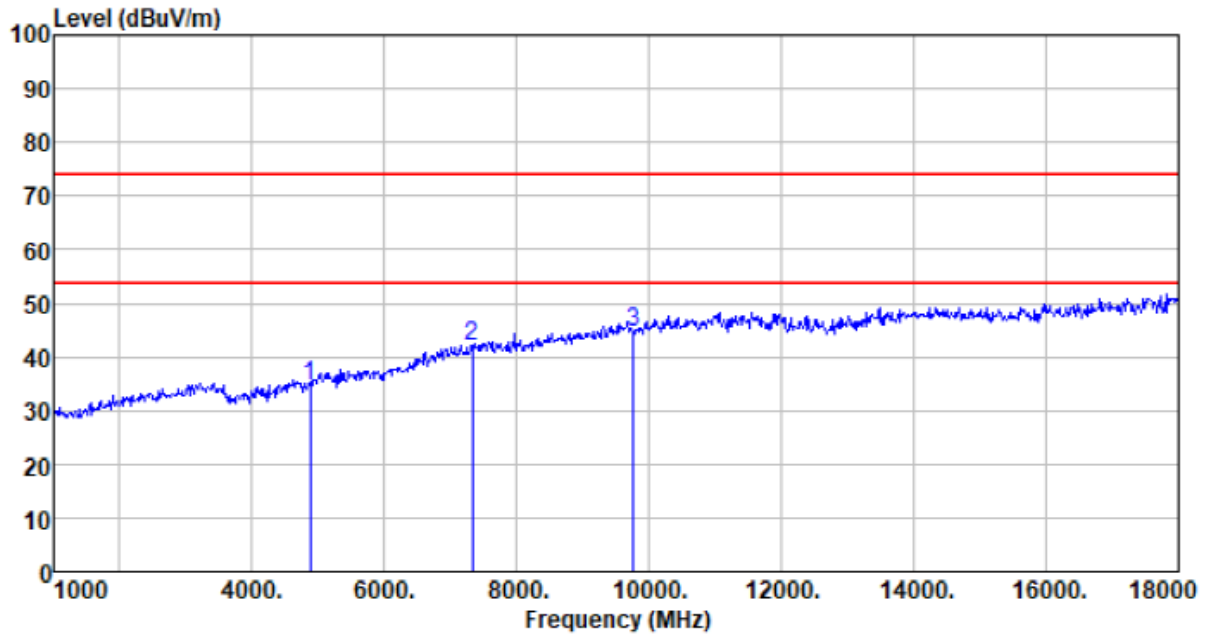

Freq MHz	Reading level dBuV	Antenna factor dB/m	Cable loss dB	Preamp factor dB	level dBuV/m	Limit level dBuV/m	Over limit dB	Remark
4880.800	37.23	31.27	4.69	38.38	34.81	74.00	-39.19	Peak
7321.200	38.30	36.14	6.63	39.00	42.07	74.00	-31.93	Peak
9762.400	38.14	38.06	8.03	39.73	44.50	74.00	-29.50	Peak

Test channel:	Highest	Polarization:	Horizontal
---------------	---------	---------------	------------

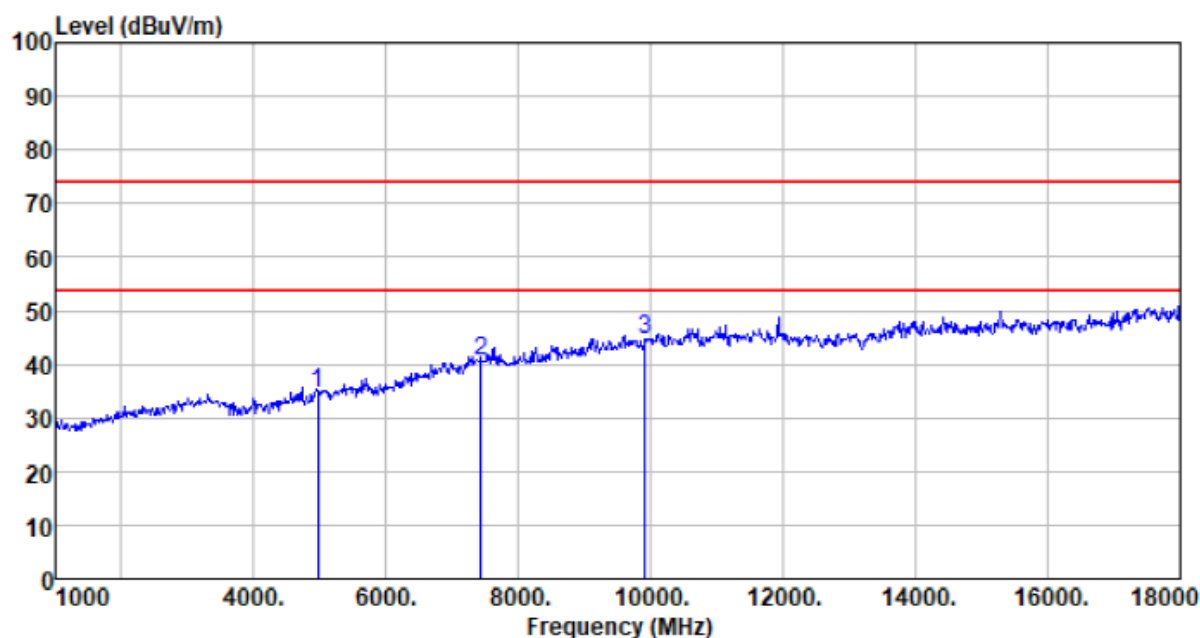

Freq MHz	Reading level dBuV	Antenna factor dB/m	Cable loss dB	Preamp factor dB	level dBuV/m	Limit level dBuV/m	Over limit dB	Remark
4958.800	36.77	31.48	4.79	38.39	34.65	74.00	-39.35	Peak
7438.200	36.53	36.38	6.77	39.03	40.65	74.00	-33.35	Peak
9917.600	38.28	38.22	8.09	39.78	44.81	74.00	-29.19	Peak

Test channel:	Highest	Polarization:	Vertical
---------------	---------	---------------	----------

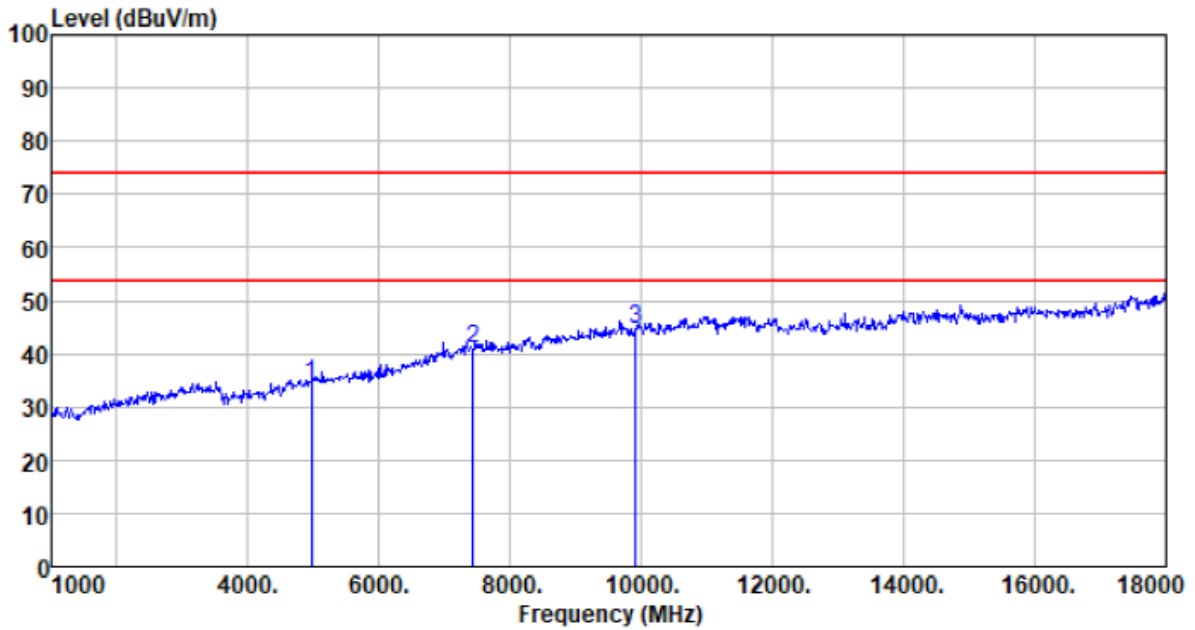

Freq MHz	Reading level dBuV	Antenna factor dB/m	Cable loss dB	Preamp factor dB	level dBuV/m	Limit level dBuV/m	Over limit dB	Remark
4958.800	36.54	31.48	4.79	38.39	34.42	74.00	-39.58	Peak
7438.200	36.95	36.38	6.77	39.03	41.07	74.00	-32.93	Peak
9917.600	38.10	38.22	8.09	39.78	44.63	74.00	-29.37	Peak

**Remark:**

1. Final Level = Receiver Read level + Antenna Factor + Cable Loss – Preamplifier Factor
2. “\*”, means this data is the too weak instrument of signal is unable to test.
3. The emission levels of other frequencies are very lower than the limit and not show in test report.
4. For above 18GHz, no emission found.



- Unwanted Emissions in Restricted Frequency Bands
- ANT 1

Test channel:	Lowest	Polarization:	Horizontal
---------------	--------	---------------	------------

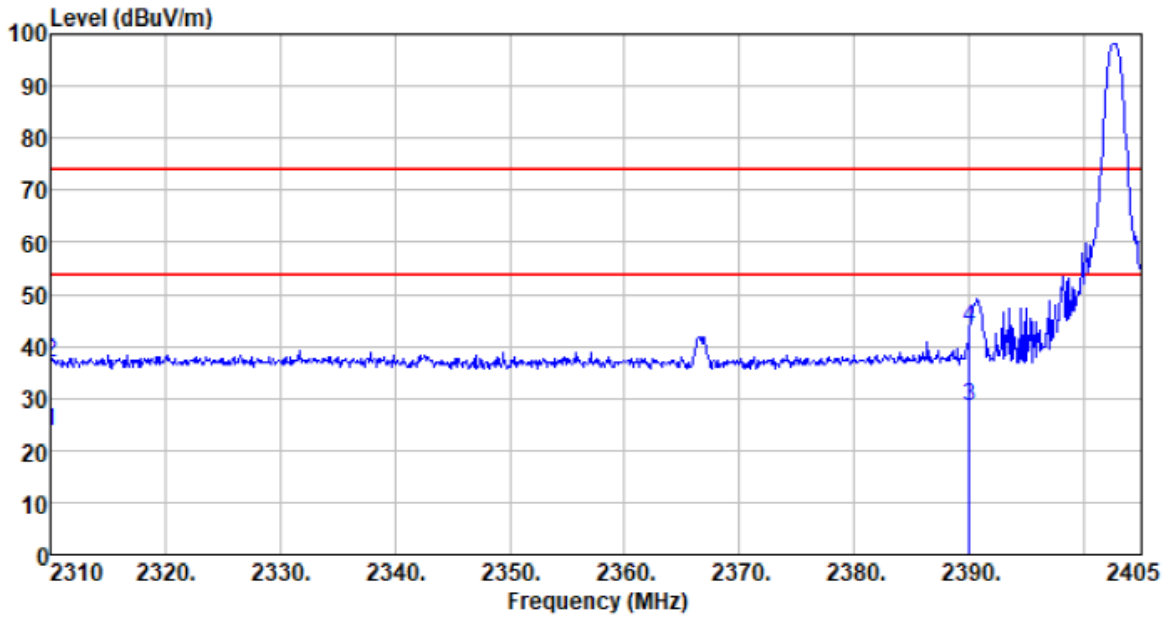

Freq MHz	Reading level dBuV	Antenna factor dB/m	Cable loss dB	Preamp factor dB	level dBuV/m	Limit level dBuV/m	Over limit dB	Remark
2310.000	32.26	27.17	2.81	38.52	23.72	54.00	-30.28	Average
2310.000	45.36	27.17	2.81	38.52	36.82	74.00	-37.18	Peak
2390.000	36.66	27.27	2.91	38.56	28.28	54.00	-25.72	Average
2390.000	51.84	27.27	2.91	38.56	43.46	74.00	-30.54	Peak

Test channel:	Lowest	Polarization:	Vertical
---------------	--------	---------------	----------

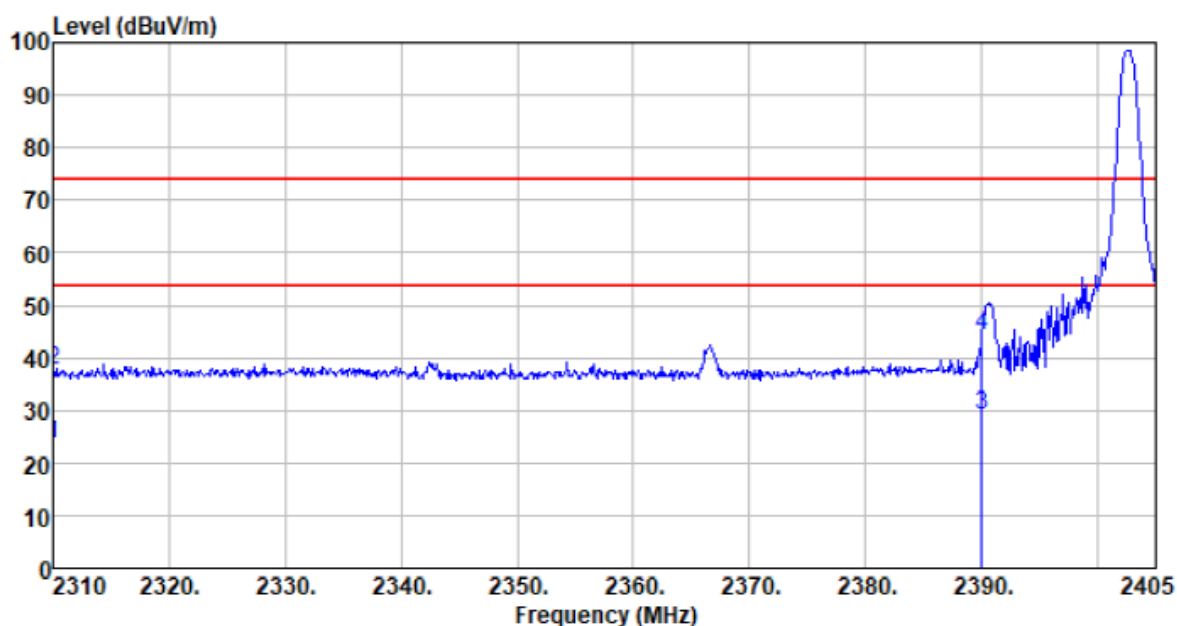

Freq MHz	Reading level dBuV	Antenna factor dB/m	Cable loss dB	Preamp factor dB	level dBuV/m	Limit level dBuV/m	Over limit dB	Remark
2310.000	32.34	27.17	2.81	38.52	23.80	54.00	-30.20	Average
2310.000	46.16	27.17	2.81	38.52	37.62	74.00	-36.38	Peak
2390.000	37.59	27.27	2.91	38.56	29.21	54.00	-24.79	Average
2390.000	52.80	27.27	2.91	38.56	44.42	74.00	-29.58	Peak

Test channel:	Highest	Polarization:	Horizontal
---------------	---------	---------------	------------

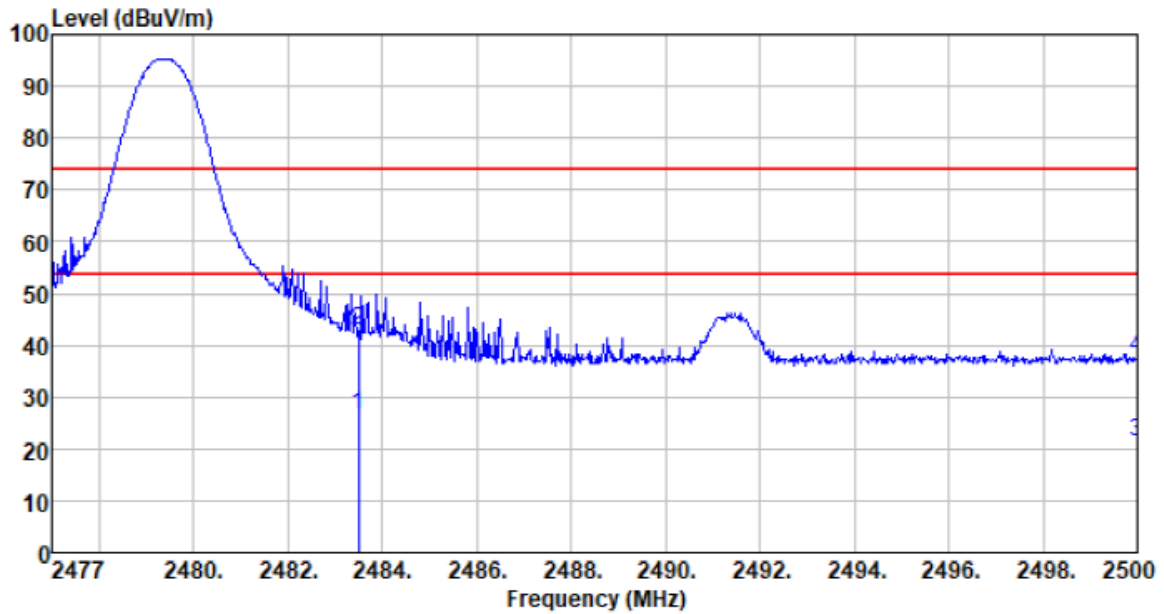

Freq MHz	Reading level dBuV	Antenna factor dB/m	Cable loss dB	Preamp factor dB	level dBuV/m	Limit level dBuV/m	Over limit dB	Remark
2483.500	34.62	27.38	2.99	38.59	26.40	54.00	-27.60	Average
2483.500	50.88	27.38	2.99	38.59	42.66	74.00	-31.34	Peak
2500.000	29.67	27.40	3.01	38.60	21.48	54.00	-32.52	Average
2500.000	45.73	27.40	3.01	38.60	37.54	74.00	-36.46	Peak

Test channel:	Highest	Polarization:	Vertical
---------------	---------	---------------	----------

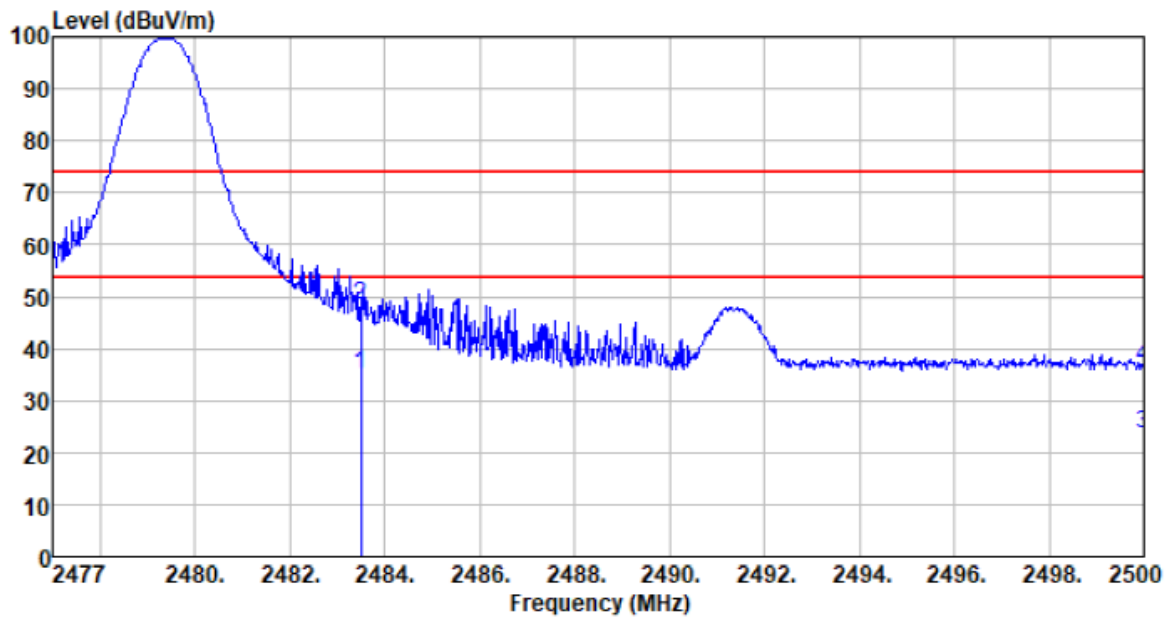

Freq MHz	Reading level dBuV	Antenna factor dB/m	Cable loss dB	Preamp factor dB	level dBuV/m	Limit level dBuV/m	Over limit dB	Remark
2483.500	43.32	27.38	2.99	38.59	35.10	54.00	-18.90	Average
2483.500	56.55	27.38	2.99	38.59	48.33	74.00	-25.67	Peak
2500.000	31.63	27.40	3.01	38.60	23.44	54.00	-30.56	Average
2500.000	44.87	27.40	3.01	38.60	36.68	74.00	-37.32	Peak



■ ANT 2

Test channel:	Lowest	Polarization:	Horizontal
---------------	--------	---------------	------------

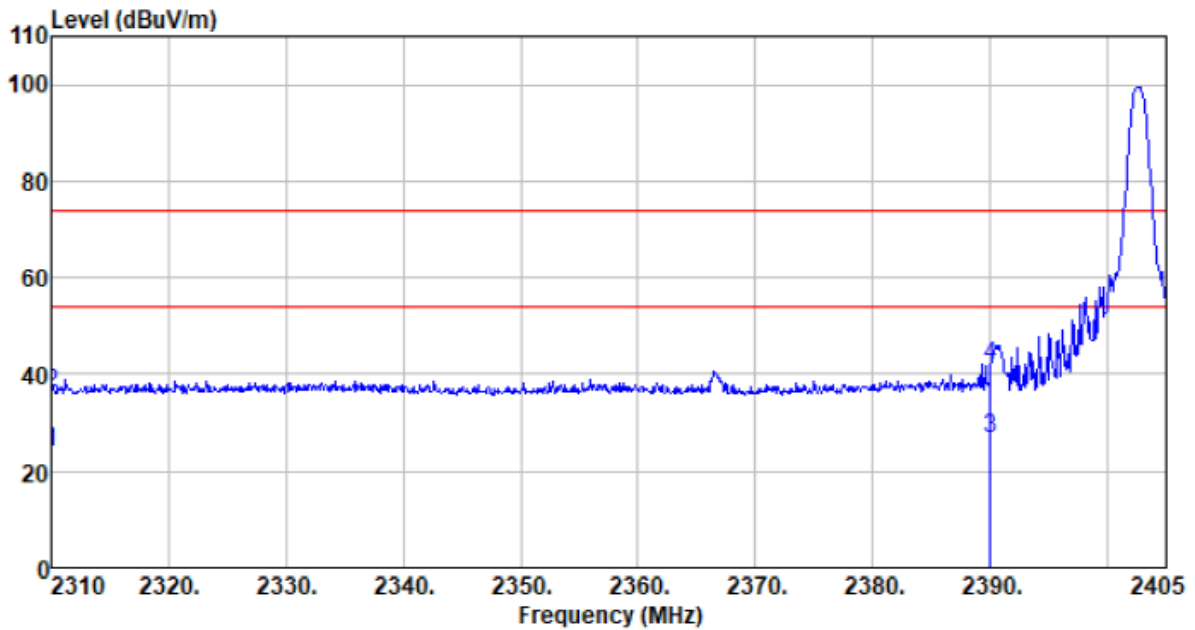

Freq MHz	Reading level dBuV	Antenna factor dB/m	Cable loss dB	Preamp factor dB	level dBuV/m	Limit level dBuV/m	Over limit dB	Remark
2310.000	32.40	27.17	2.81	38.52	23.86	54.00	-30.14	Average
2310.000	44.58	27.17	2.81	38.52	36.04	74.00	-37.96	Peak
2390.000	35.15	27.27	2.91	38.56	26.77	54.00	-27.23	Average
2390.000	50.36	27.27	2.91	38.56	41.98	74.00	-32.02	Peak

Test channel:	Lowest	Polarization:	Vertical
---------------	--------	---------------	----------

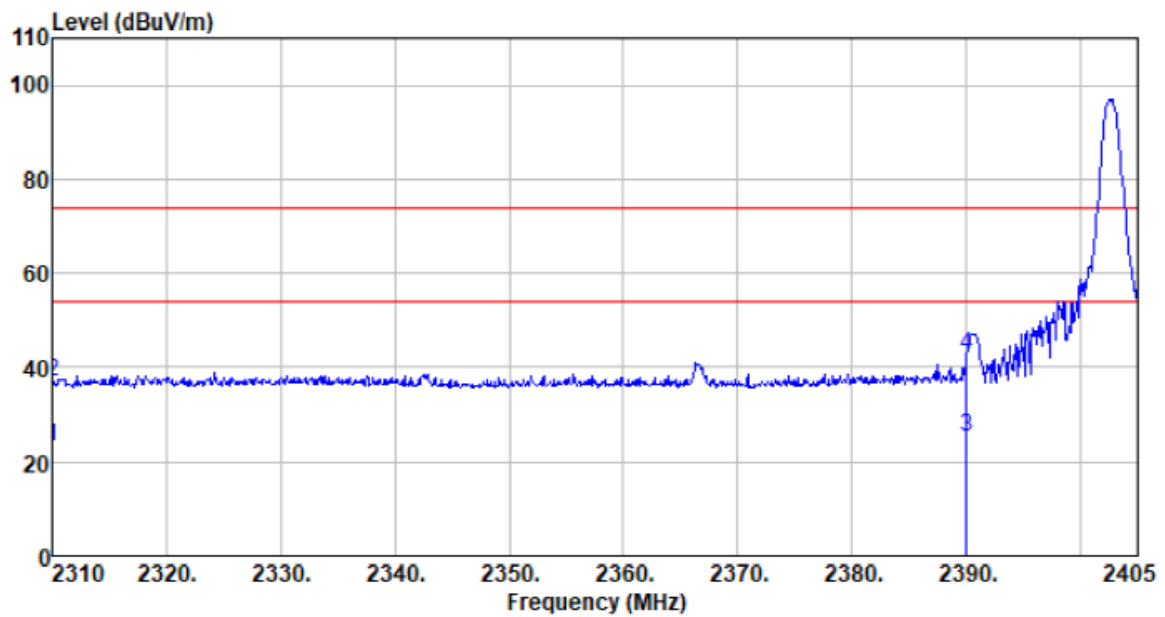

Freq MHz	Reading level dBuV	Antenna factor dB/m	Cable loss dB	Preamp factor dB	level dBuV/m	Limit level dBuV/m	Over limit dB	Remark
2310.000	31.49	27.17	2.81	38.52	22.95	54.00	-31.05	Average
2310.000	45.39	27.17	2.81	38.52	36.85	74.00	-37.15	Peak
2390.000	33.64	27.27	2.91	38.56	25.26	54.00	-28.74	Average
2390.000	50.88	27.27	2.91	38.56	42.50	74.00	-31.50	Peak

Test channel:	Highest	Polarization:	Horizontal
---------------	---------	---------------	------------

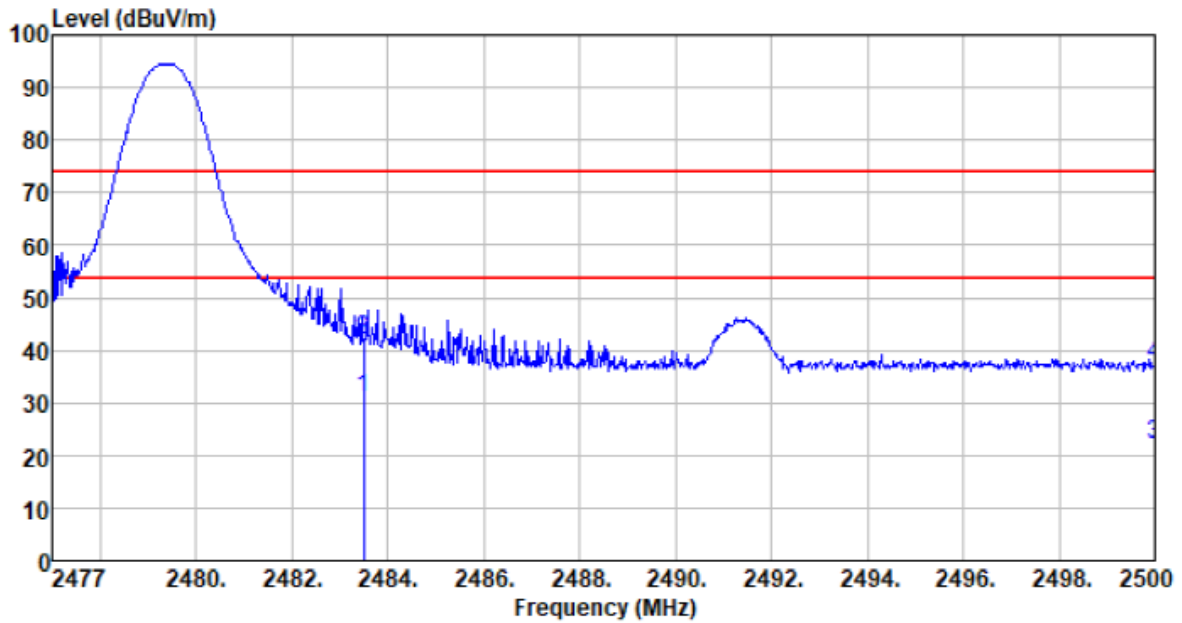

Freq MHz	Reading level dBuV	Antenna factor dB/m	Cable loss dB	Preamp factor dB	level dBuV/m	Limit level dBuV/m	Over limit dB	Remark
2483.500	39.21	27.38	2.99	38.59	30.99	54.00	-23.01	Average
2483.500	50.19	27.38	2.99	38.59	41.97	74.00	-32.03	Peak
2500.000	30.41	27.40	3.01	38.60	22.22	54.00	-31.78	Average
2500.000	45.58	27.40	3.01	38.60	37.39	74.00	-36.61	Peak

Test channel:	Highest	Polarization:	Vertical
---------------	---------	---------------	----------

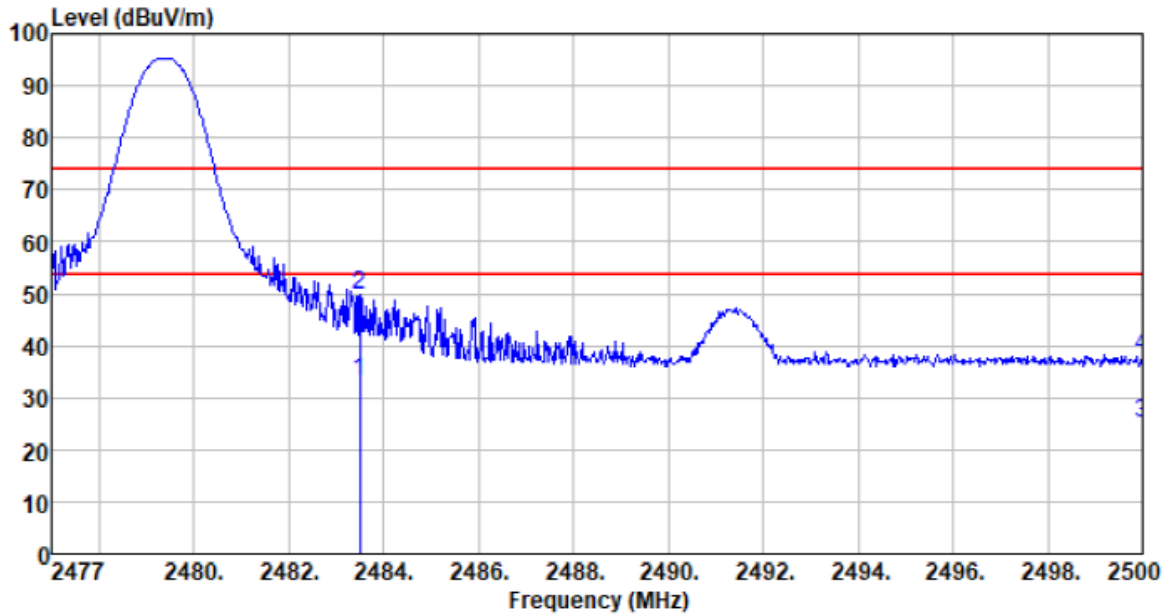

Freq MHz	Reading level dBuV	Antenna factor dB/m	Cable loss dB	Preamp factor dB	level dBuV/m	Limit level dBuV/m	Over limit dB	Remark
2483.500	41.34	27.38	2.99	38.59	33.12	54.00	-20.88	Average
2483.500	58.10	27.38	2.99	38.59	49.88	74.00	-24.12	Peak
2500.000	33.20	27.40	3.01	38.60	25.01	54.00	-28.99	Average
2500.000	46.08	27.40	3.01	38.60	37.89	74.00	-36.11	Peak

**Remarks:**

1. Final Level = Receiver Read level + Antenna Factor + Cable Loss – Pre-amplifier Factor
2. The emission levels of other frequencies are very lower than the limit and not show in test report.



## **8 Test Setup Photo**

Reference to the **appendix I** for details.

## **9 EUT Constructional Details**

Reference to the **appendix II** for details.

---End---