

TEST REPORT

FCC Rules Part 15.225

Report Reference No..... : MTEB24070286-R
FCC ID..... : 2A2RN-ACEVCEVL001
 Compiled by
 (position+printed name+signature): File administrators Alisa Luo



Supervised by
 (position+printed name+signature): Test Engineer Sunny Deng



Approved by
 (position+printed name+signature): Manager Yvette Zhou



Date of issue..... : **July 19,2024**

Representative Laboratory Name : **Shenzhen Most Technology Service Co., Ltd.**

Address : No.5, 2nd Langshan Road, North District, Hi-tech Industrial Park, Nanshan, Shenzhen, Guangdong, China.

Applicant's name : **Xiamen Joint Tech. Co., Ltd**

Address : Building #1, No.268 HouXiang Rd, Xinyang, Industrial Park, Haicang District, XIAMEN, Fujian, China.

Test specification/ Standard..... : **FCC Rules Part 15.225**

TRF Originator..... : Shenzhen Most Technology Service Co., Ltd.

Shenzhen Most Technology Service Co., Ltd. All rights reserved.

This publication may be reproduced in whole or in part for non-commercial purposes as long as the Shenzhen Most Technology Service Co., Ltd. is acknowledged as copyright owner and source of the material. Shenzhen Most Technology Service Co., Ltd. takes no responsibility for and will not assume liability for damages resulting from the reader's interpretation of the reproduced material due to its placement and context.

Test item description : Electric Vehicle AC Charger

Trade Mark : Joint

Model/Type reference..... : JNT-EVL001/48AC/01C/BK/RF/WF

Listed Models : JNT-EVL001/XXAC/01C/YY/RF/ZZ (XXstands for Electric current; YYstands for colour; ZZ stands for communication mode)

Modulation Type : ASK

Operation Frequency..... : 13.56MHz

Hardware Version..... : V1.0

Software Version : V00.01.01

Rating : AC 240V/60Hz

Result..... : PASS

TEST REPORT

Equipment under Test : Electric Vehicle AC Charger

Model /Type : JNT-EVL001/48AC/01C/BK/RF/WF

Listed Models : JNT-EVL001/XXAC/01C/YY/RF/ZZ (XXstands for Electric current,YYstands for colour,ZZ stands for communication mode)

Remark : Difference in Appearance colour and current.

Applicant : **Xiamen Joint Tech. Co., Ltd**

Address : Building #1, No.268 HouXiang Rd, Xinyang, Industrial Park, Haicang District, XIAMEN, Fujian, China.

Manufacturer : **Xiamen Joint Tech. Co., Ltd**

Address : Building #1, No.268 HouXiang Rd, Xinyang, Industrial Park, Haicang District, XIAMEN, Fujian, China.

Test Result:	PASS
---------------------	-------------

The test report merely corresponds to the test sample.
 It is not permitted to copy extracts of these test result without the written permission of the test laboratory.

Contents

1. REVISION HISTORY	4
2. TEST STANDARDS	5
3. SUMMARY	6
3.1. General Remarks	6
3.2. Product Description	6
3.3. Equipment Under Test	6
3.4. Short description of the Equipment under Test (EUT)	6
3.5. EUT operation mode	6
3.6. Block Diagram of Test Setup.....	6
3.7. Test Item (Equipment Under Test) Description*	7
3.8. Auxiliary Equipment (AE) Description	7
3.9 Antenna Information*	7
3.10. EUT configuration	7
3.11. Modifications	7
4. TEST ENVIRONMENT	8
4.1. Address of the test laboratory	8
4.2. Environmental conditions	8
4.3. Test Description	9
4.4. Statement of the measurement uncertainty	9
4.5. Equipments Used during the Test	10
5. TEST CONDITIONS AND RESULTS	11
5.1. AC Power Conducted Emission.....	11
5.2. Radiated Emission	14
5.3. 20dB Bandwidth	21
5.4. FREQUENCY TOLERANCE.....	22
5.5. Antenna Requirement	23
6. TEST SETUP PHOTOS OF THE EUT	24
7. EXTERNAL AND INTERNAL PHOTOS OF THE EUT	25

1. Revision History

Revision	Issue Date	Revisions	Revised By
00	2024-07-19	Initial Issue	Alisa Luo

2. TEST STANDARDS

The tests were performed according to following standards:

The tests were performed according to following standards:

[FCC Rules Part 15.225](#): Operation within the band 13.110-14.010 MHz.

[ANSI C63.10:2013](#) : American National Standard for Testing Unlicensed Wireless Devices

[ANSI C63.4: 2014](#): –American National Standard for Methods of Measurement of Radio-Noise Emissions from Low-Voltage Electrical and Electronic Equipment in the Range of 9 kHz to 40GHz
Range of 9 kHz to 40GHz

3. SUMMARY

3.1. General Remarks

Date of receipt of test sample	:	2024.07.14
Testing commenced on	:	2024.07.15
Testing concluded on	:	2024.07.19

3.2. Product Description

Product Name:	Electric Vehicle AC Charger
Model/Type reference:	JNT-EVL001/48AC/01C/BK/RF/WF
Power Supply:	AC 240V/60Hz
Testing sample ID:	MTYP06026
Modulation:	ASK
Operation frequency:	13.56MHZ
Channel number:	1 (declared by the client)

3.3. Equipment Under Test

Power supply system utilised

Power supply voltage	:	<input type="radio"/> 230V / 50 Hz	<input type="radio"/> 120V / 60Hz
		<input type="radio"/> 12 V DC	<input type="radio"/> 24 V DC
		<input checked="" type="radio"/> Other (specified in blank below)	

AC 240V/60Hz

3.4. Short description of the Equipment under Test (EUT)

This is a Electric Vehicle AC Charger For more details, refer to the user's manual of the EUT.

3.5. EUT operation mode

Channel	Freq.(MHz)	Note(Modulation Type)
1	13.56MHz	ASK

3.6. Block Diagram of Test Setup

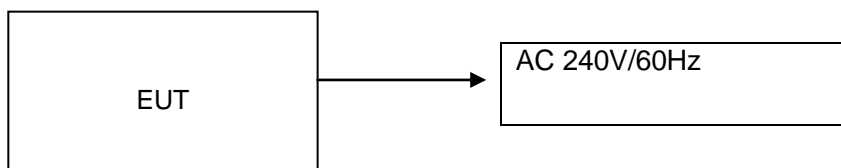

3.7. Test Item (Equipment Under Test) Description*

Short designation	EUT Name	EUT Description	Serial number	Hardware status	Software status
EUT A	/	/	/	/	/
EUT B	/	/	/	/	/
EUT C	/	/	/	/	/

*: declared by the applicant. According to customers information EUTs A and B are the same devices. Only the secondary screen size is different

3.8. Auxiliary Equipment (AE) Description

AE short designation	EUT Name (if available)	EUT Description	Serial number (if available)	Software (if used)
AE 1	/	/	/	/
AE 2	/	/	/	/

3.9 Antenna Information*

Short designation	Antenna Name	Antenna Type	Frequency Range	Serial number	Antenna Peak Gain
Antenna 1	---	/	PCB Antenna	13.56MHZ	3dBi
Antenna 2	/	/	/	/	/

*: declared by the applicant.

3.10. EUT configuration

The following peripheral devices and interface cables were connected during the measurement:

● - supplied by the manufacturer

○ - Supplied by the lab

●	ADAPTER 1	M/N:	/
		Manufacturer:	/

3.11. Modifications

No modifications were implemented to meet testing criteria.

4. TEST ENVIRONMENT

4.1. Address of the test laboratory

Shenzhen Most Technology Service Co., Ltd.

No.5, 2nd Langshan Road, North District, Hi-tech Industrial Park, Nanshan, Shenzhen, Guangdong, China.
The 3m-Semi anechoic test site fulfils CISPR 16-1-4 according to ANSI C63.4:2014 and CISPR 16-1-4:2010 SVSWR requirement for radiated emission above 1GHz.

Test Facility

The test facility is recognized, certified, or accredited by the following organizations:

FCC-Registration No.: 0031192610

Shenzhen Most Technology Service Co., Ltd. EMC Laboratory has been registered and fully described in a report filed with the (FCC) Federal Communications Commission. The acceptance letter from the FCC is maintained in our files.

A2LA-Lab Cert. No.: 6343.01

Shenzhen Most Technology Service Co., Ltd. EMC Laboratory has been accredited by A2LA for technical competence in the field of electrical testing, and proved to be in compliance with ISO/IEC 17025: 2005 General Requirements for the Competence of Testing and Calibration Laboratories and any additional program requirements in the identified field of testing.

4.2. Environmental conditions

Radiated Emission:

Temperature:	23 ° C
Humidity:	48 %
Atmospheric pressure:	950-1050mbar

Conducted testing:

Temperature:	24 ° C
Humidity:	45 %
Atmospheric pressure:	950-1050mbar

4.3. Test Description

FCC and IC Requirements		
FCC Part 15.203	Antenna Requirement	PASS
FCC Part 15.207	AC Power Conducted Emission	PASS
FCC Part 15.209&15.205 (a) &15.225(a,b,c,d)	Spurious Emissions	PASS
FCC Part 15.215 (c) &15.225	20dB Occupied Bandwidth	PASS
FCC Part 15.225(e)	Frequency Tolerance	PASS

Remark:

1. The measurement uncertainty is not included in the test result.
2. NA = Not Applicable; NP = Not Performed

4.4. Statement of the measurement uncertainty

The data and results referenced in this document are true and accurate. The reader is cautioned that there may be errors within the calibration limits of the equipment and facilities. The measurement uncertainty was calculated for all measurements listed in this test report acc. to CISPR 16 - 4 „Specification for radio disturbance and immunity measuring apparatus and methods – Part 4: Uncertainty in EMC Measurements“ and is documented in the Shenzhen Most Technology Service Co., Ltd. quality system acc. to DIN EN ISO/IEC 17025. Furthermore, component and process variability of devices similar to that tested may result in additional deviation. The manufacturer has the sole responsibility of continued compliance of the device.

Hereafter the best measurement capability for Shenzhen Most Technology Service Co., Ltd. is reported:

Test	Range	Measurement Uncertainty	Notes
Radiated Emission	30~1000MHz	4.10 dB	(1)
Radiated Emission	1~18GHz	4.32 dB	(1)
Radiated Emission	18-40GHz	5.54 dB	(1)
Conducted Disturbance	0.15~30MHz	3.12 dB	(1)
20dB Occupied Bandwidth	/	5%	(1)

- (1) This uncertainty represents an expanded uncertainty expressed at approximately the 95% confidence level using a coverage factor of k=2.

4.5. Equipments Used during the Test

5.

Item	Equipment	Manufacturer	Model No.	Serial No.	Firmware versions	Last Cal.	Cal. Interval
1.	L.I.S.N.	R&S	ENV216	100093	/	2024/03/15	1 Year
2	Three-phase artificial power network	Schwarzback Mess	NNLK8129	8129178	/	2024/03/15	1 Year
3.	Receiver	R&S	ESCI	100492	V3.0-10-2	2024/03/15	1 Year
4	Receiver	R&S	ESPI	101202	V3.0-10-2	2024/03/15	1 Year
5	Spectrum analyzer	Agilent	9020A	MT-E306	A14.16	2024/03/15	1 Year
6	Bilong Antenna	Sunol Sciences	JB3	A121206	/	2023/08/15	1 Year
7	Horn antenna	HF Antenna	HF Antenna	MT-E158	/	2024/03/15	1 Year
8	Loop antenna	Beijing Daze	ZN30900B	/	/	2024/03/15	1 Year
9	Horn antenna	R&S	OBH100400	26999002	/	2024/03/15	1 Year
10	Wireless Communication Test Set	R&S	CMW500	/	CMW-BASE-3.7.21	2024/03/15	1 Year
11	Spectrum analyzer	R&S	FSP	100019	V4.40 SP2	2024/03/15	1 Year
12	High gain antenna	Schwarzbeck	LB-180400KF	MT-E389	/	2024/03/15	1 Year
13	Preamplifier	Schwarzbeck	BBV 9743	MT-E390	/	2024/03/15	1 Year
14	Pre-amplifier	EMCI	EMC051845S E	MT-E391	/	2024/03/15	1 Year
15	Pre-amplifier	Agilent	83051A	MT-E392	/	2024/03/15	1 Year
16	High pass filter unit	Tonscend	JS0806-F	MT-E393	/	2024/03/15	1 Year
17	RF Cable(below1GHz)	Times	9kHz-1GHz	MT-E394	/	2024/03/15	1 Year
18	RF Cable(above 1GHz)	Times	1-40G	MT-E395	/	2024/03/15	1 Year
19	RF Cable (9KHz-40GHz)	Tonscend	170660	N/A	/	2024/03/15	1 Year

6. Note: The Cal.Interval was one year.

5. TEST CONDITIONS AND RESULTS

5.1. AC Power Conducted Emission

TEST CONFIGURATION

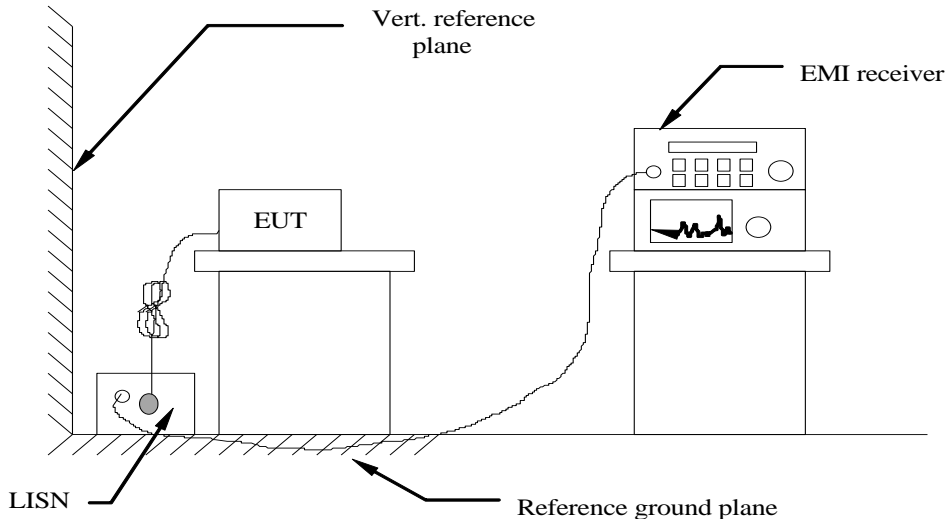

TEST PROCEDURE

- 1 The equipment was set up as per the test configuration to simulate typical actual usage per the user's manual. The EUT is a tabletop system, a wooden table with a height of 0.8 meters is used and is placed on the ground plane as per ANSI C63.10-2013.
- 2 Support equipment, if needed, was placed as per ANSI C63.10-2013
- 3 All I/O cables were positioned to simulate typical actual usage as per ANSI C63.10-2013
- 4 The EUT received DC5V power, the adapter received AC120V/60Hz power through a Line Impedance Stabilization Network (LISN) which supplied power source and was grounded to the ground plane.
- 5 All support equipments received AC power from a second LISN, if any.
- 6 The EUT test program was started. Emissions were measured on each current carrying line of the EUT using a spectrum Analyzer / Receiver connected to the LISN powering the EUT. The LISN has two monitoring points: Line 1 (Hot Side) and Line 2 (Neutral Side). Two scans were taken: one with Line 1 connected to Analyzer / Receiver and Line 2 connected to a 50 ohm load; the second scan had Line 1 connected to a 50 ohm load and Line 2 connected to the Analyzer / Receiver.
- 7 Analyzer / Receiver scanned from 150 KHz to 30MHz for emissions in each of the test modes.
- 8 During the above scans, the emissions were maximized by cable manipulation.

AC Power Conducted Emission Limit

For unintentional device, according to RSS Gen 8.8 and § 15.207(a) Line Conducted Emission Limits is as following:

Frequency (MHz)	Maximum RF Line Voltage	
	Quasi-Peak Level dB(μ V)	Average Level dB(μ V)
0.15 ~ 0.50	66 ~ 56*	56 ~ 46*
0.50 ~ 5.00	56	46
5.00 ~ 30.00	60	50

TEST RESULTS

Pass

Remark: only the worst test data is shown

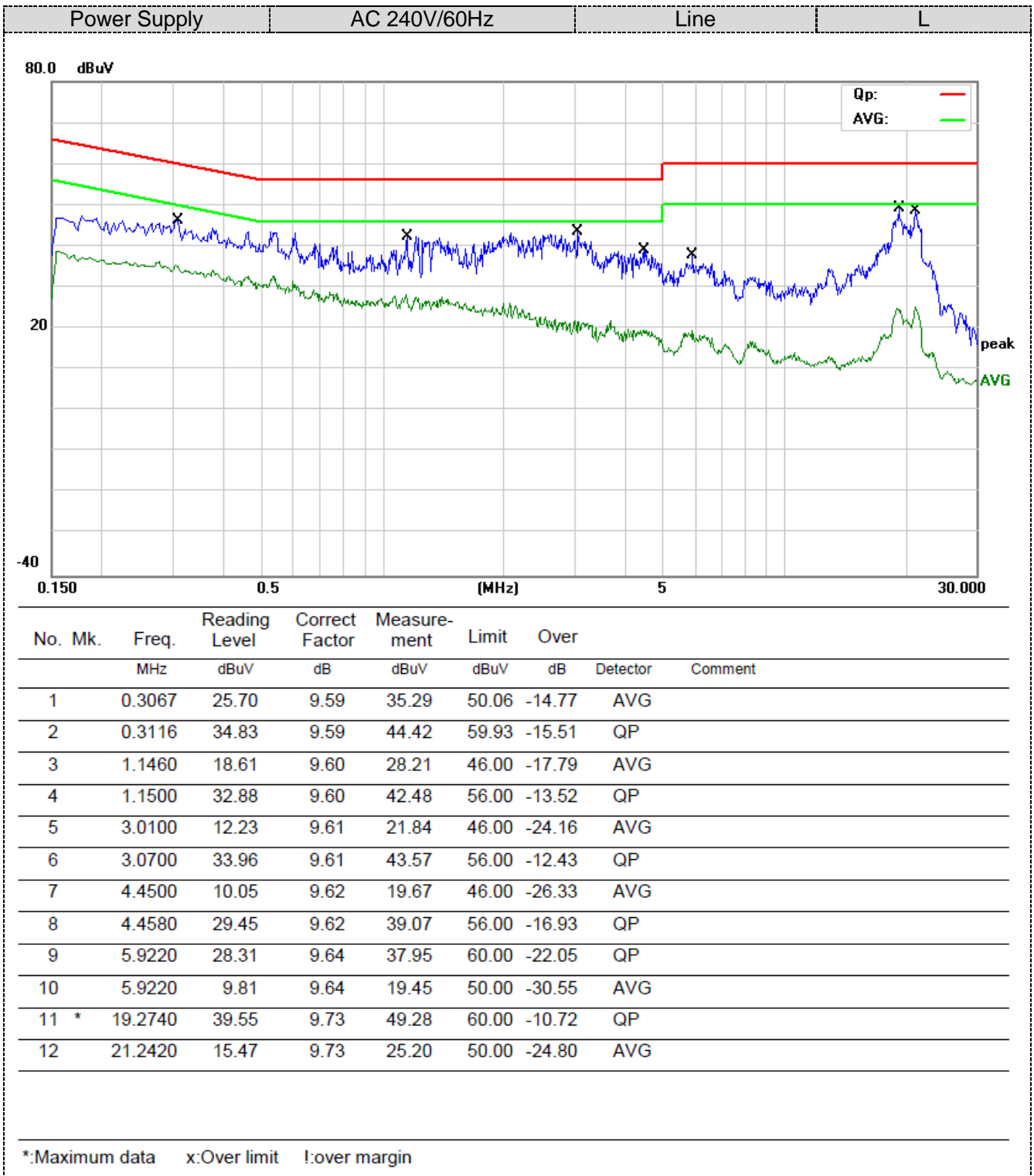

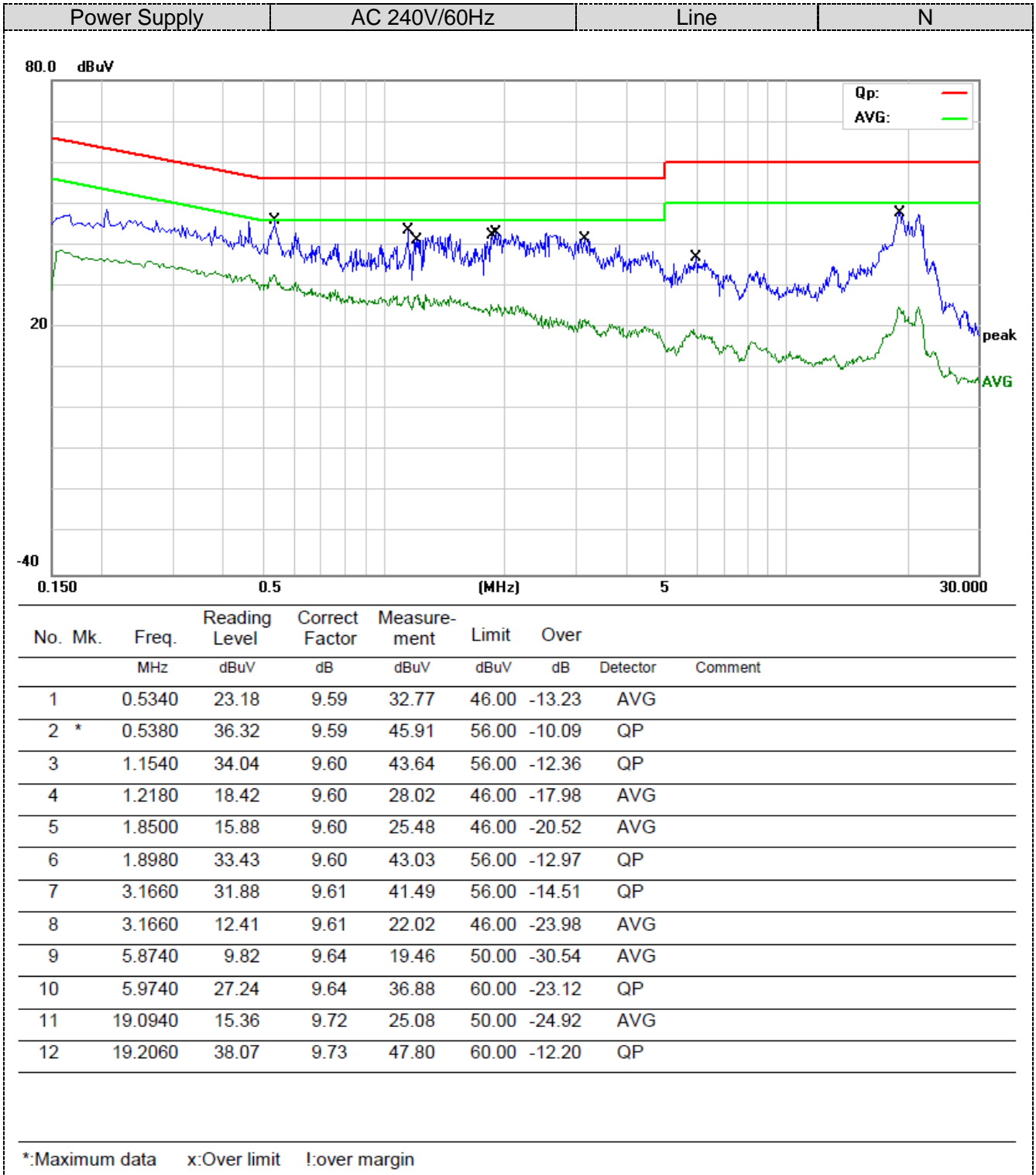

5.2. Radiated Emission

TEST CONFIGURATION

Frequency range 9 KHz – 30MHz

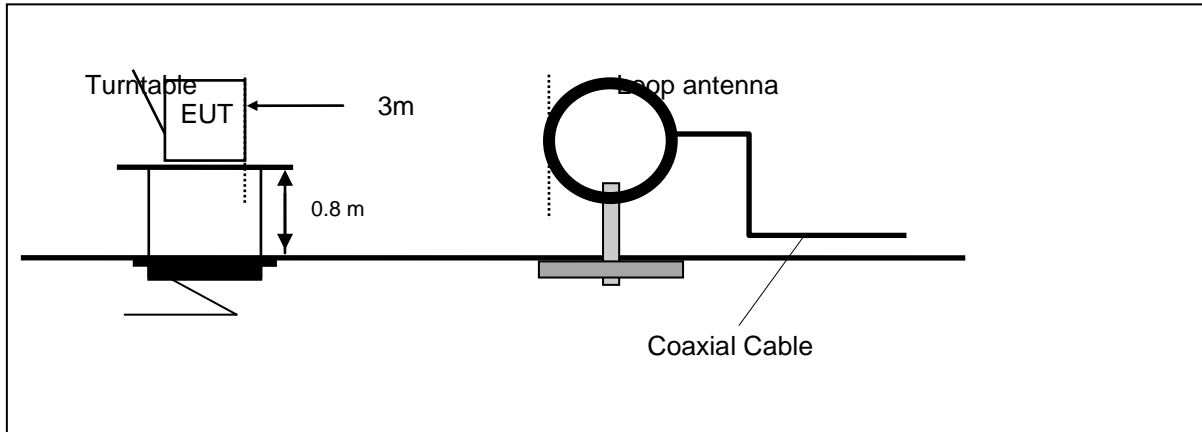

Frequency range 30MHz – 1000MHz

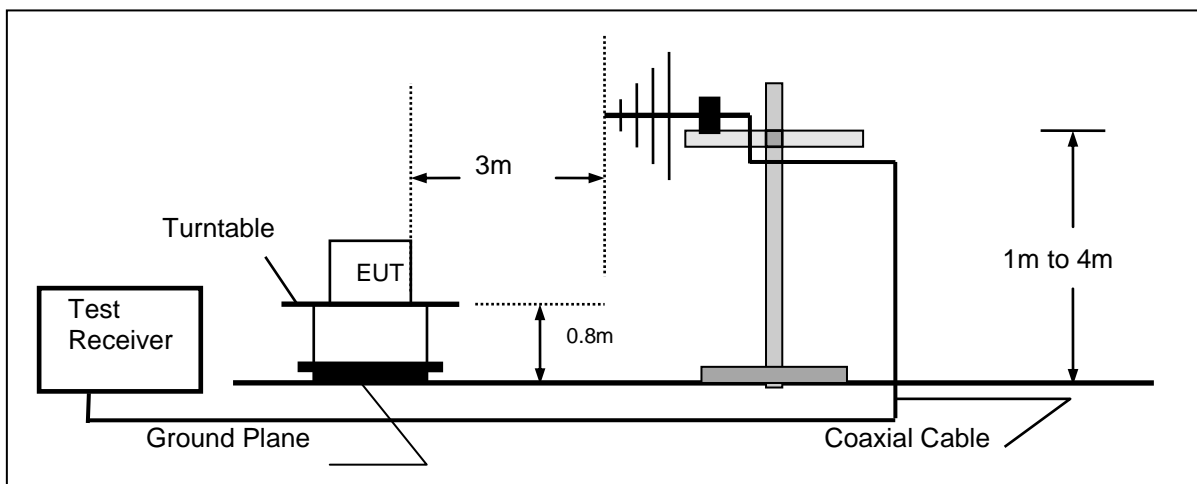

Frequency range above 1GHz-25GHz

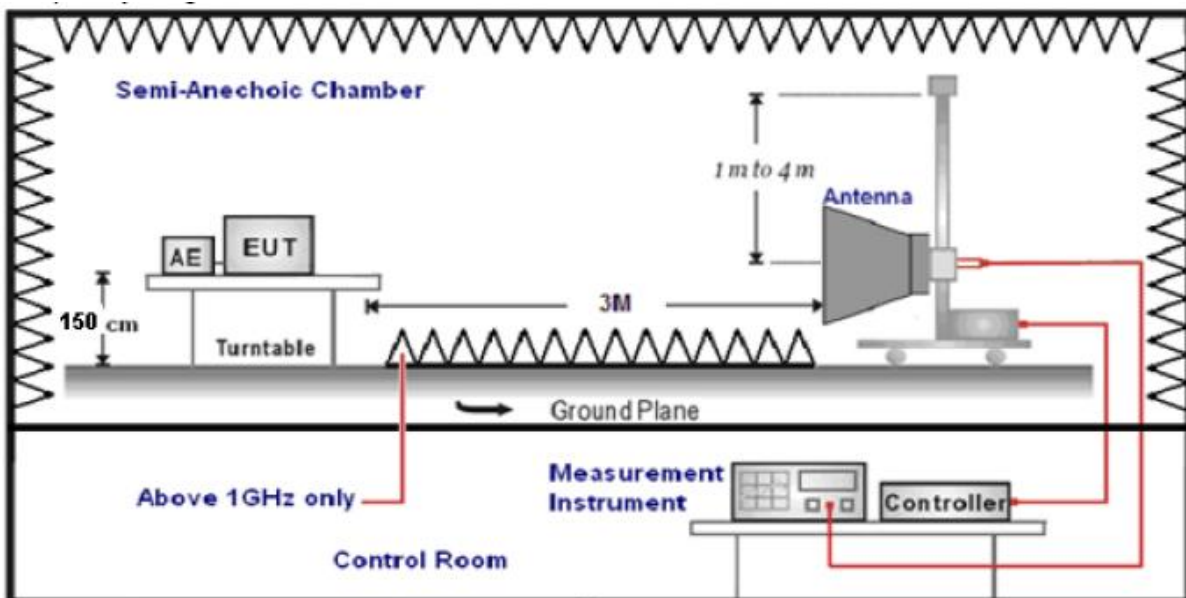

TEST PROCEDURE

1. The EUT was placed on a turn table which is 0.8m above ground plane when testing frequency range 9 KHz –1GHz;the EUT was placed on a turn table which is 1.5m above ground plane when testing frequency range 1GHz – 25GHz.
2. Maximum procedure was performed by raising the receiving antenna from 1m to 4m and rotating the turn table from 0°C to 360°C to acquire the highest emissions from EUT.
3. And also, each emission was to be maximized by changing the polarization of receiving antenna both horizontal and vertical.
4. Repeat above procedures until all frequency measurements have been completed.
5. The EUT minimum operation frequency was 32.768KHz and maximum operation frequency was 2480MHz.so radiated emission test frequency band from 9KHz to 25GHz.
6. The distance between test antenna and EUT as following table states:

Test Frequency range	Test Antenna Type	Test Distance
9KHz-30MHz	Active Loop Antenna	3
30MHz-1GHz	Ultra-Broadband Antenna	3
1GHz-18GHz	Double Ridged Horn Antenna	3
18GHz-25GHz	Horn Antenna	1

7. Setting test receiver/spectrum as following table states:

Test Frequency range	Test Receiver/Spectrum Setting	Detector
9KHz-150KHz	RBW=200Hz/VBW=3KHz, Sweep time=Auto	QP
150KHz-30MHz	RBW=9KHz/VBW=100KHz, Sweep time=Auto	QP
30MHz-1GHz	RBW=120KHz/VBW=1000KHz, Sweep time=Auto	QP
1GHz-40GHz	Peak Value: RBW=1MHz/VBW=3MHz, Sweep time=Auto Average Value: RBW=1MHz/VBW=10Hz, Sweep time=Auto	Peak

Field Strength Calculation

The field strength is calculated by adding the Antenna Factor and Cable Factor and subtracting the Amplifier Gain and Duty Cycle Correction Factor(if any) from the measured reading. The basic equation with a sample calculation is as follows:

FS = RA + AF + CL - AG

Where	FS = Field Strength	CL = Cable Attenuation Factor (Cable Loss)
	RA = Reading Amplitude	AG = Amplifier Gain
	AF = Antenna Factor	

Transd=AF +CL-AG

RADIATION LIMIT

For intentional device, according to § 15.209(a), the general requirement of field strength of radiated emission out of authorized band shall not exceed the following table at a 3 meters measurement distance.

In addition, radiated emissions which fall in the restricted bands, as defined in §15.205(a), must also comply with the radiated emission limits specified in §15.209(a)

Except when the requirements applicable to a given device state otherwise, emissions from licence - exempt transmitters shall comply with the field strength limits shown in table below. Additionally, the level of any transmitter emission shall not exceed the level of the transmitter’s fundamental emission

Unwanted emissions that fall into restricted bands shall comply with the limits specified in RSS-Gen; and Unwanted emissions that do not fall within the restricted frequency bands shall comply either with the limits specified in the applicable RSS or with those specified in this RSS-Gen.

Frequency (MHz)	Distance (Meters)	Radiated (dB μ V/m)	Radiated (μ V/m)
0.009-0.49	3	$20\log(2400/F(\text{KHz}))+40\log(300/3)$	$2400/F(\text{KHz})$
0.49-1.705	3	$20\log(24000/F(\text{KHz}))+40\log(30/3)$	$24000/F(\text{KHz})$
1.705-30	3	$20\log(30)+40\log(30/3)$	30
30-88	3	49.0	100
88-216	3	53.5	150
216-960	3	56.0	200
Above 960	3	64.0	500

According to FCC Part 15.205, Restricted bands

MHz	MHz	MHz	GHz
0.090-0.110	16.42-16.423	399.9-410	4.5-5.15
10.495-0.505	16.69475-16.69525	608-614	5.35-5.46
2.1735-2.1905	16.80425-16.80475	960-1240	7.25-7.75
4.125-4.128	25.5-25.67	1300-1427	8.025-8.5
4.17725-4.17775	37.5-38.25	1435-1626.5	9.0-9.2
4.20725-4.20775	73-74.6	1645.5-1646.5	9.3-9.5
6.215-6.218	74.8-75.2	1660-1710	10.6-12.7
6.26775-6.26825	123-138	2200-2300	14.47-14.5
8.291-8.294	149.9-150.05	2310-2390	15.35-16.2
8.362-8.366	156.52475-156.52525	2483.5-2500	17.7-21.4
8.37625-8.38675	156.7-156.9	2690-2900	22.01-23.12
8.41425-8.41475	162.0125-167.17	3260-3267	23.6-24.0
12.29-12.293	167.72-173.2	3332-3339	31.2-31.8
12.51975-12.52025	240-285	3345.8-3358	36.43-36.5
12.57675-12.57725	322-335.4	3600-4400	(2)
13.36-13.41			

LIMITS OF RADIATED EMISSION MEASUREMENT (FCC 15.225)

(a) The field strength of any emissions within the band 13.553-13.567 MHz shall not exceed 15,848 microvolts/meter at 30 meters, equal to 124dB μ V/m at 3 meters.

(b) Within the bands 13.410-13.553 MHz and 13.567-13.710 MHz, the field strength of any emissions shall not exceed 334 microvolts/meter at 30 meters, equal to 90.5dB μ V/m at 3 meters.

(c) Within the bands 13.110-13.410 MHz and 13.710-14.010 MHz the field strength of any emissions shall not exceed 106 microvolts/meter at 30 meters, equal to 80.5dB μ V/m at 3 meters..

(d) The field strength of any emissions appearing outside of the 13.110-14.010 MHz band shall not exceed the general radiated emission limits in § 15.209.

TEST RESULTS (BELOW 30MHz)

1: This test was performed with EUT in X, Y, Z position and the worse case was found when EUT in X position.

2: Radiated emission test from 9 KHz to 10th harmonic of fundamental was verified, and no emission found except system noise floor in 9 KHz to 30MHz and not recorded in this report.

X

Remark: only the worst test data is shown

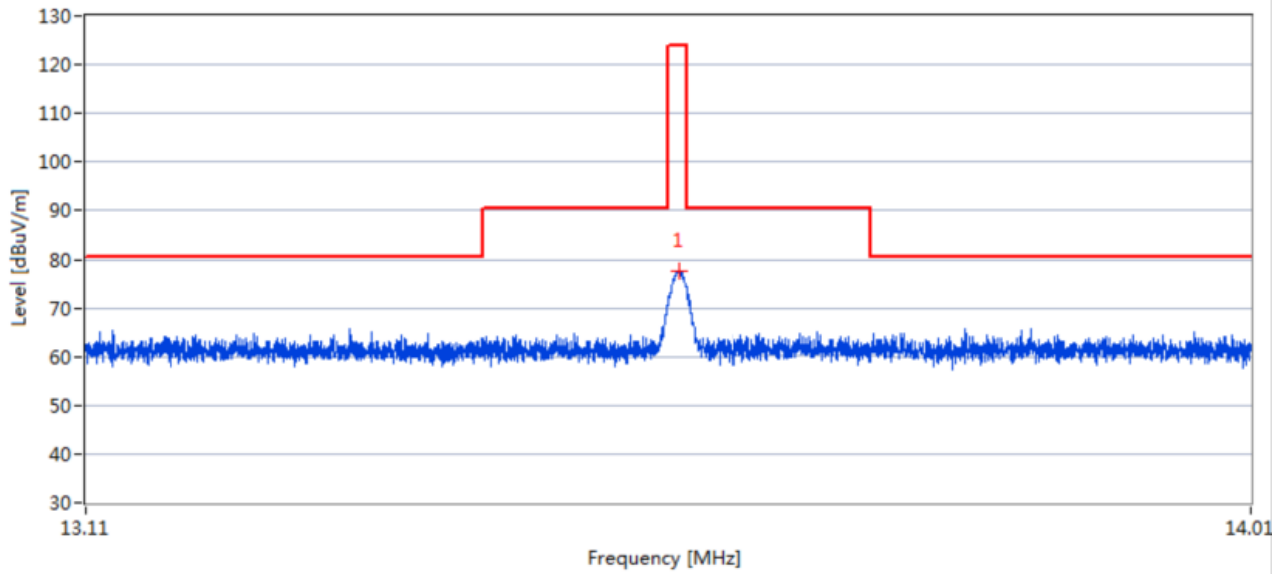

Frequency	Pre-scan Level MaxPeak	Final Test Level MaxPeak	Limit MaxPeak	Margin
MHz	dBuV/m	dBuV/m	dBuV/m	dB
13.56	77.9	77.9	124.0	45.8

Y

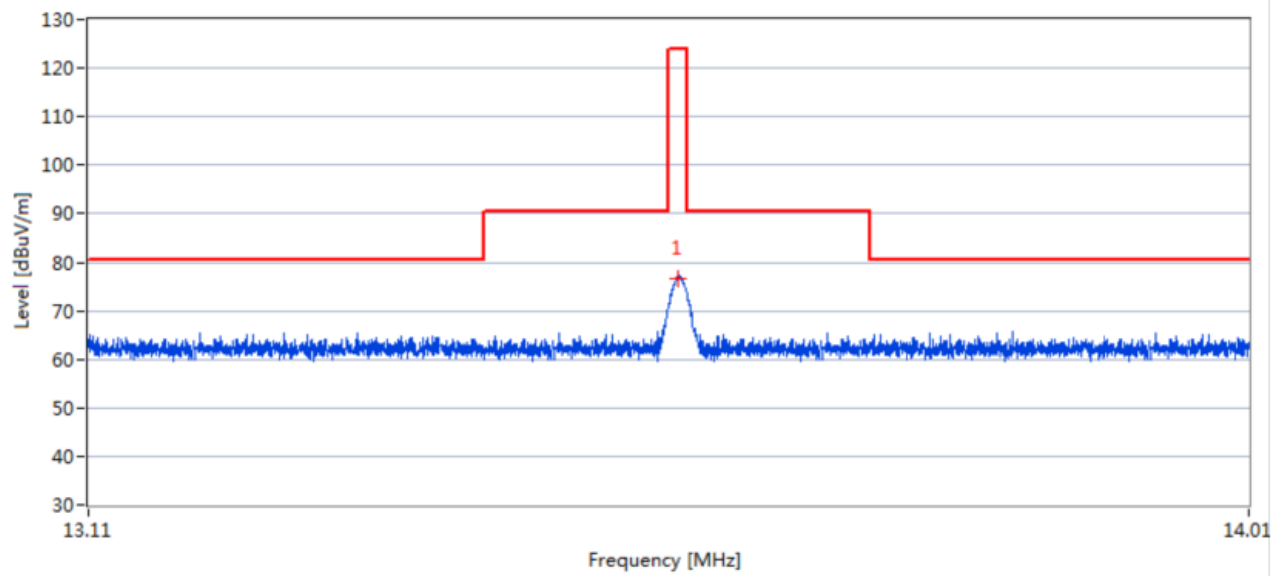

Frequency	Pre-scan Level MaxPeak	Final Test Level MaxPeak	Limit MaxPeak	Margin
MHz	dBuV/m	dBuV/m	dBuV/m	dB
13.56	78.9	78.9	124.0	46.5

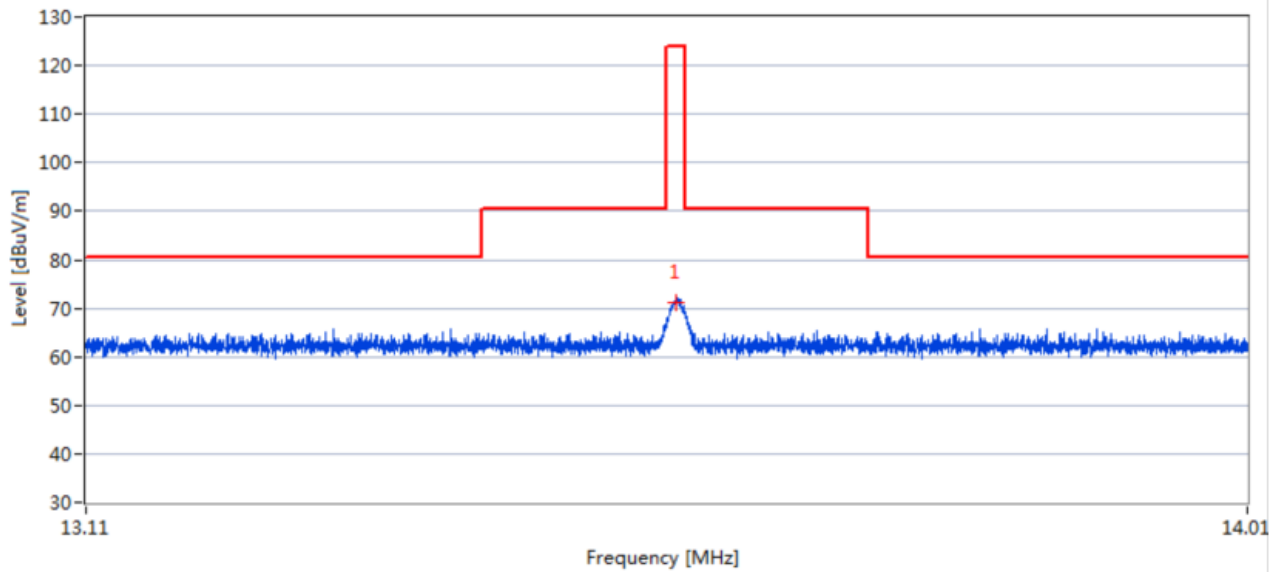

Frequency	Pre-scan Level MaxPeak	Final Test Level MaxPeak	Limit MaxPeak	Margin
MHz	dBuV/m	dBuV/m	dBuV/m	dB
13.56	74.1	74.1	124.0	51.5

For 30MHz-1GHz

Power Supply	AC 240V/60Hz	Polarization	Horizontal
--------------	--------------	--------------	------------

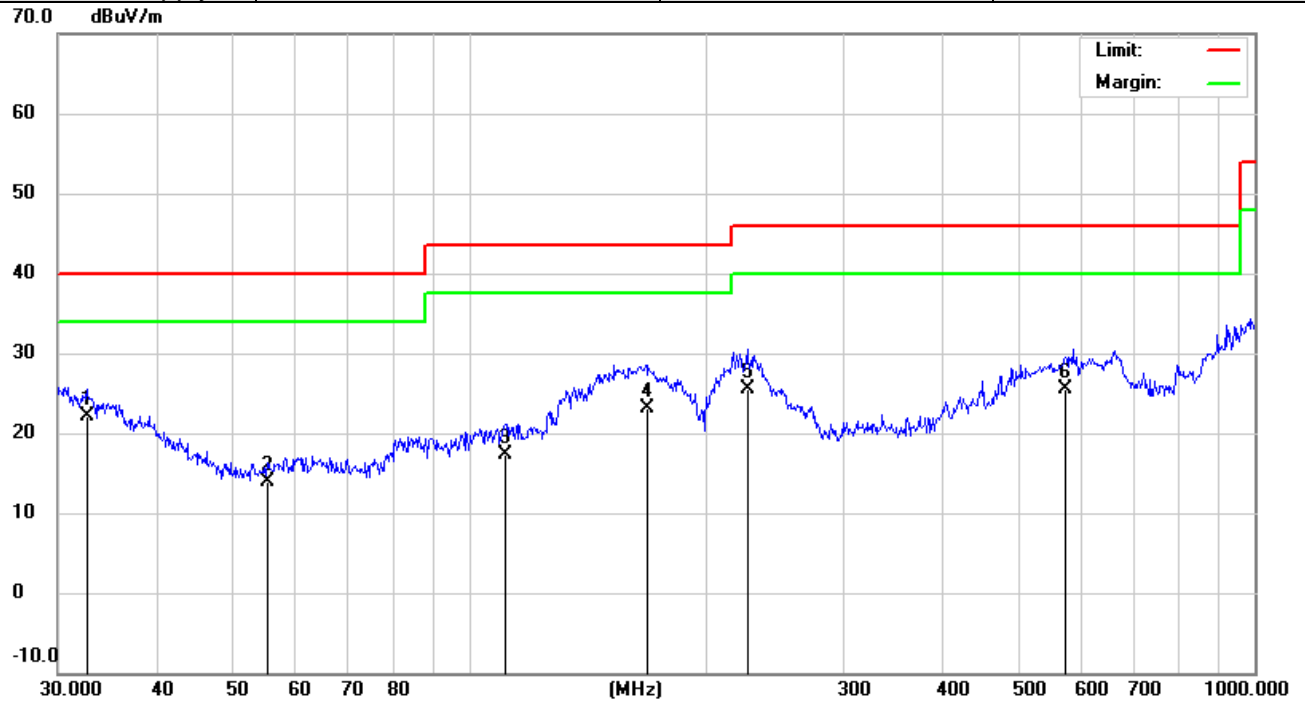

No.	Mk.	Freq. MHz	Reading Level dBuV	Correct Factor dB	Measure- ment dBuV/m	Limit dBuV/m	Over dB	Antenna Height cm	Table Degree degree	Comment
1	*	32.6340	3.00	19.11	22.11	40.00	-17.89	QP	200	23
2		55.4147	5.60	8.37	13.97	40.00	-26.03	QP	200	86
3		111.3468	2.50	14.85	17.35	43.50	-26.15	QP	200	143
4		168.4137	6.00	17.02	23.02	43.50	-20.48	QP	200	186
5		226.0994	11.00	14.47	25.47	46.00	-20.53	QP	200	249
6		574.6258	2.00	23.52	25.52	46.00	-20.48	QP	200	302

*:Maximum data x:Over limit !:over margin

Power Supply AC 240V/60Hz Polarization Vertical

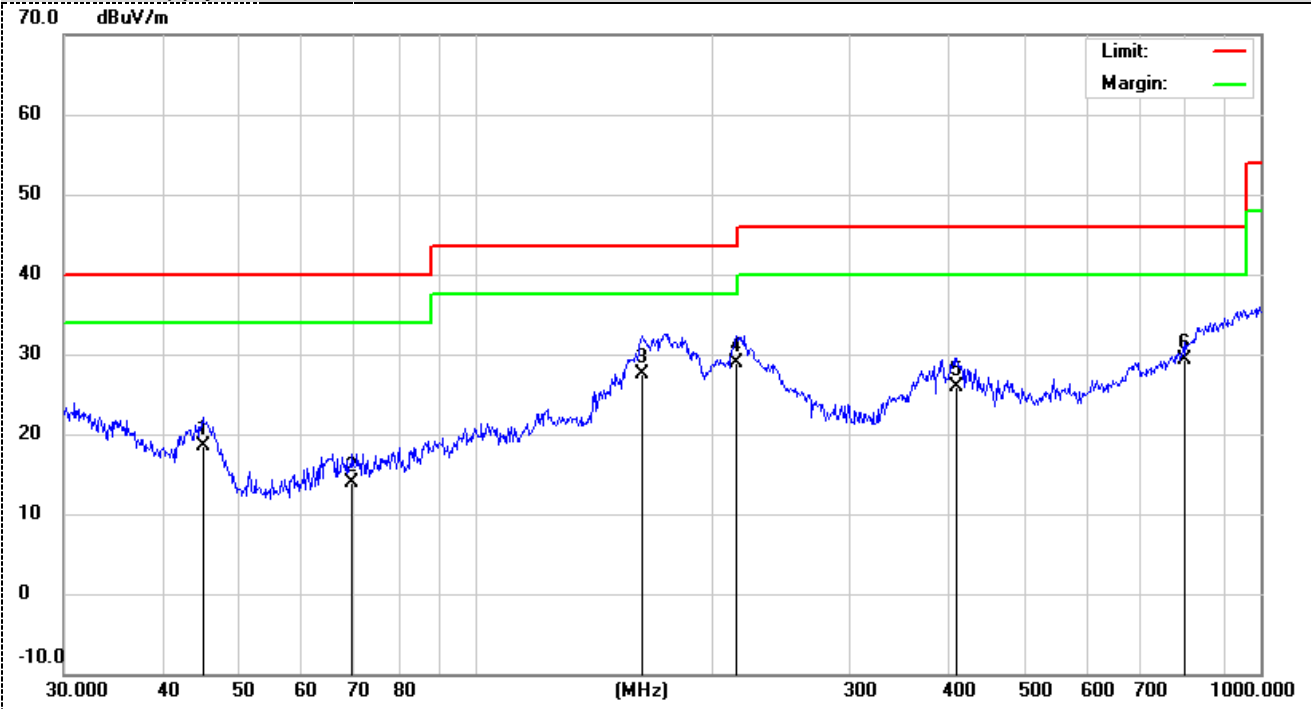

No.	Mk.	Freq.	Reading Level	Correct Factor	Measurement	Limit	Over	Antenna Height	Table Degree	Comment
		MHz	dBuV	dB	dBuV/m	dBuV/m	dB	cm	degree	
1		45.0583	8.00	10.47	18.47	40.00	-21.53	QP	100	32
2		69.8449	4.60	9.29	13.89	40.00	-26.11	QP	100	101
3		163.1817	10.30	17.19	27.49	43.50	-16.01	QP	100	188
4	*	215.2678	14.20	14.77	28.97	43.50	-14.53	QP	100	243
5		410.3824	8.00	17.95	25.95	46.00	-20.05	QP	100	289
6		798.9797	1.50	27.87	29.37	46.00	-16.63	QP	100	324

*:Maximum data x:Over limit !:over margin

5.3. 20dB Bandwidth

TEST CONFIGURATION

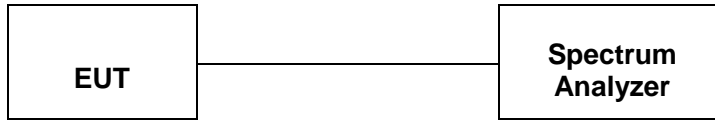

TEST PROCEDURE

The 20dB bandwidth and 99% bandwidth is measured with a spectrum analyzer connected via a receive antenna placed near the EUT while the EUT is operating in transmission mode.

The 20dB bandwidth is defined as the total spectrum the power of which is higher than peak power minus 20dB.

The occupied bandwidth (OBW), that is the frequency bandwidth such that, below its lower and above its upper frequency limits, the mean powers radiated are each equal to 0.5 percent of the total mean power radiated by a given emission

TEST RESULTS

Modulation	Channel Frequency (MHz)	20dB bandwidth (KHz)	Result
ASK	13.56	28.1	Pass

Test plot as follows:

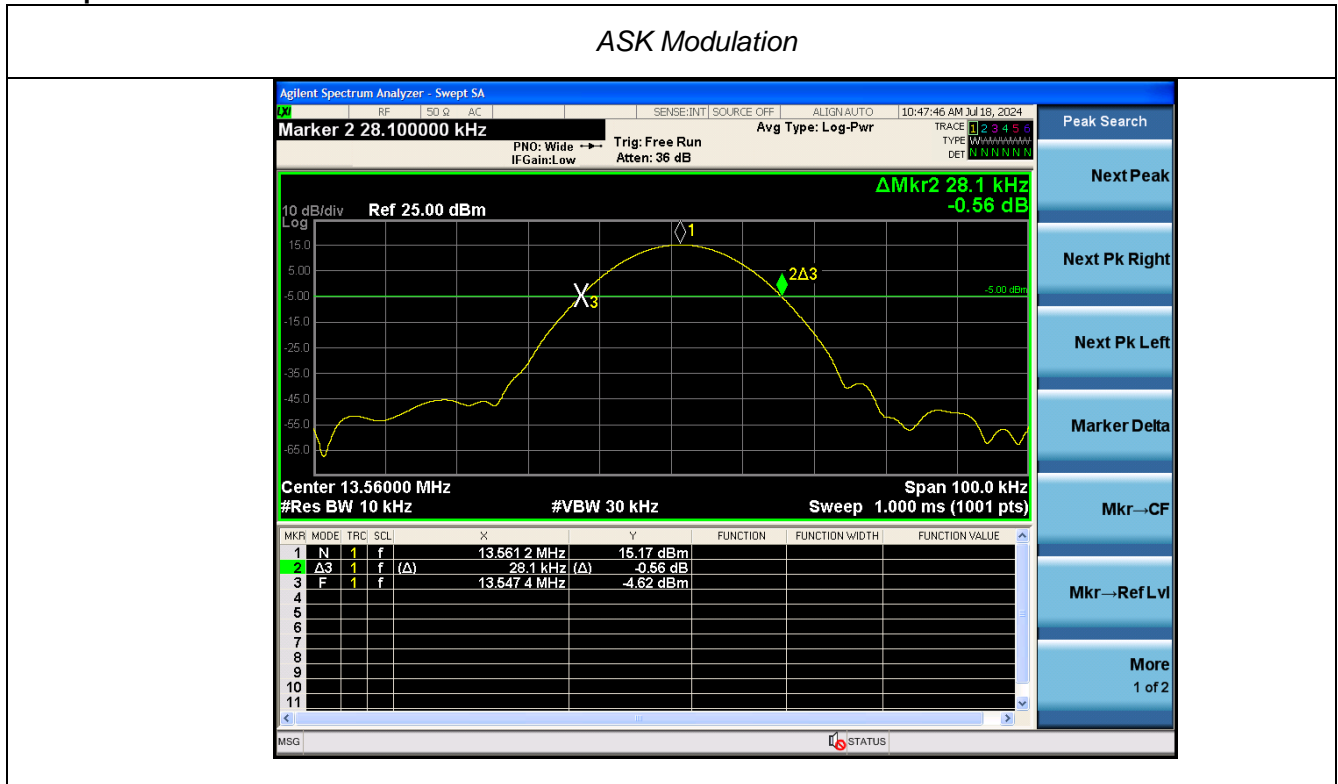

5.4. FREQUENCY TOLERANCE

TEST CONFIGURATION

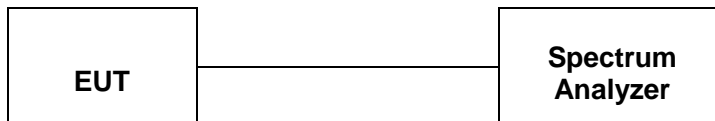

TEST PROCEDURE

The EUT was placed on a turn table which is 0.8m above ground plane.

Set EUT as normal operation

Set SPA Center Frequency = fundamental frequency, RBW, VBW= 10kHz, Span=100K

Set SPA Max hold. Mark peak.

TEST RESULTS

Power Supply	Temperature(°C)	Measured Frequency (MHz)	Frequency Error (MHz)	Result(ppm)	Part 15.225 Limit
DC 264V	-20	13.560036	0.000036	2.68	+/- 0.01%(100ppm)
	20	13.560075	0.000075	5.52	+/- 0.01%(100ppm)
	50	13.560039	0.000039	2.85	+/- 0.01%(100ppm)
DC 240V	-20	13.560068	0.000068	5.04	+/- 0.01%(100ppm)
	20	13.560080	0.000080	5.88	+/- 0.01%(100ppm)
	50	13.560025	0.000025	1.82	+/- 0.01%(100ppm)
DC 216V	-20	13.560031	0.000031	2.29	+/- 0.01%(100ppm)
	20	13.560056	0.000056	4.16	+/- 0.01%(100ppm)
	50	13.560060	0.000060	4.40	+/- 0.01%(100ppm)

5.5. Antenna Requirement

Standard Applicable

For intentional device, according to FCC 47 CFR Section 15.203:

An intentional radiator shall be designed to ensure that no antenna other than that furnished by the responsible party shall be used with the device. The use of a permanently attached antenna or of an antenna that uses a unique coupling to the intentional radiator, the manufacturer may design the unit so that a broken antenna can be replaced by the user, but the use of a standard antenna jack or electrical connector is prohibited

Test Result:

The EUT has a built in antenna which is integrated inside the enclosure, this is permanently attached antenna and meets the requirements of this section.

Results: Compliance.

6. Test Setup Photos of the EUT

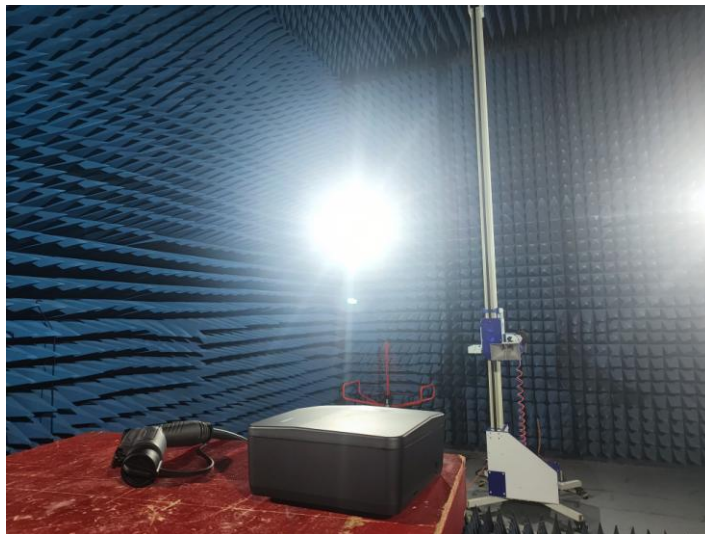
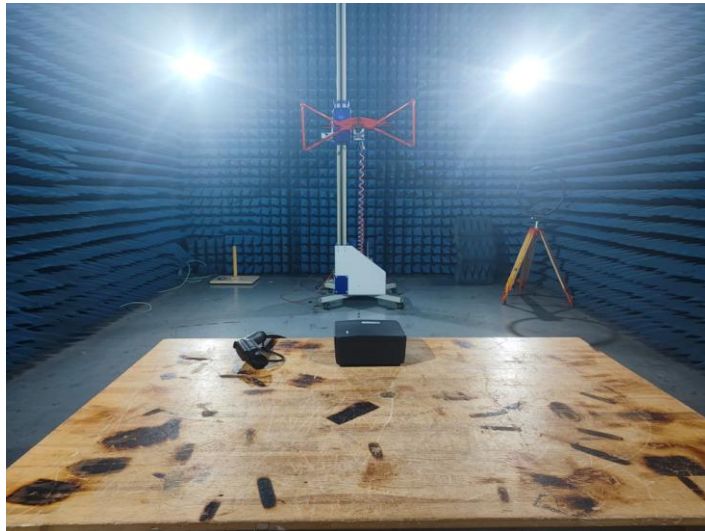

7. External and Internal Photos of the EUT

See related photo report.

.....**End of Report**.....