

FCC RADIO TEST REPORT

FCC ID: 2A2QEYJ-100

Sample : Power Supply/Controller

Trade Name :   
  
  
ATOMI SMART, Yunjin, Mlambert, Liquid leds, LITANG, Qllaa

Main Model : YJ-100

Additional Model : N/A

Report No. : UNIA22101710ER-61

Prepared for

Yuyao Yunjin Electrical Appliance Co., Ltd
No.5 Gongji Road ,Simen Town,Yuyao,Ningbo,Zhejiang,China

Prepared by

Shenzhen United Testing Technology Co., Ltd.
2F, Annex Bldg, Jiahuangyuan Tech Park, #365 Baotian 1 Rd, Tiegang
Community, Xixiang Str, Bao'an District, Shenzhen, China

TEST RESULT CERTIFICATION

Applicant : Yuyao Yunjin Electrical Appliance Co., Ltd
Address : No.5 Gongji Road ,Simen Town,Yuyao,Ningbo,Zhejiang,China
Manufacturer..... : Yuyao Yunjin Electrical Appliance Co., Ltd
Address : No.5 Gongji Road ,Simen Town,Yuyao,Ningbo,Zhejiang,China

Product description

Product..... : Power Supply/Controller

Trade Name..... :













ATOMI SMART, Yunjin, Mlambert, Liquid leds, LITANG, Qllaa

Model Name : YJ-100

Test Methods..... : FCC Rules and Regulations Part 15 Subpart C Section 15.247
 ANSI C63.10: 2013

This device described above has been tested by Shenzhen United Testing Technology Co., Ltd., and the test results show that the equipment under test (EUT) is in compliance with the FCC requirements. And it is applicable only to the tested sample identified in the report.

This report shall not be reproduced except in full, without the written approval of UNI, this document may be altered or revised by Shenzhen United Testing Technology Co., Ltd., personnel only, and shall be noted in the revision of the document.

Date of Test :
Date (s) of performance of tests..... : Oct. 17, 2022 ~ Oct. 26, 2022
Date of Issue..... : Nov. 04, 2022
Test Result..... : Pass

Prepared by: kahn.yang

 Kahn yang/Supervisor

Reviewer: *Kelly Cheng*

 Kelly Cheng/Supervisor

Approved & Authorized Signer: *Liuze*

 Liuze/Manager

Table of Contents

Page

1 TEST SUMMARY	5
1.1 TEST PROCEDURES AND RESULTS	5
1.2 TEST FACILITY	6
1.3 MEASUREMENT UNCERTAINTY	7
1.4 ENVIRONMENTAL CONDITIONS	7
2 GENERAL INFORMATION	8
2.1 GENERAL DESCRIPTION OF EUT	8
2.2 CARRIER FREQUENCY OF CHANNELS	9
2.3 TEST MODE	10
2.4 DESCRIPTION OF THE TEST MODES	10
2.5 TEST SETUP	11
2.6 DESCRIPTION TEST PERIPHERAL AND EUT PERIPHERAL	11
2.7 MEASUREMENT INSTRUMENTS LIST	12
3 CONDUCTED EMISSION	13
3.1 TESTLIMIT	13
3.2 TEST SETUP	13
3.3 TEST PROCEDURE	14
3.4 TEST RESULT	14
4 RADIATED EMISSION	17
4.1 TESTLIMIT	17
4.2 TEST SETUP	18
4.3 TEST PROCEDURE	19
4.4 TEST RESULT	19
5 OCCUPIED BANDWIDTH	42
5.1 TESTLIMIT	42
5.2 TEST PROCEDURE	42
5.3 EQUIPMENT USED	42
5.4 TEST RESULT	42
6 POWER SPECTRAL DENSITY	51
6.1 TESTLIMIT	51
6.2 TEST PROCEDURE	51
6.3EQUIPMENT USED	51
6.4 TESTRESULT	51
7 PEAK OUTPUT POWER	60
7.1 TESTLIMIT	60

Table of Contents	Page
7.2 TEST PROCEDURE	60
7.3 EQUIPMENT USED	60
7.4 TEST RESULT	60
8 OUT OF BAND EMISSIONS	61
8.1 TEST LIMIT	61
8.2 TEST SETUP	61
8.3 TEST PROCEDURE	61
8.4 TEST RESULT	61
9 ANTENNA REQUIREMENT	74
10 PHOTO OF TEST	75
10.1 RADIATED EMISSION	75
10.2 CONDUCTED EMISSION	76

1 TEST SUMMARY

1.1 TEST PROCEDURES AND RESULTS

Item	FCC Rules	Description Of Test	Result
1	FCC Part 15.207	Conducted Emission	Pass
2	FCC Part 15.209(a)	Radiated Emission	Pass
3	FCC Part 15.247(a)(2)	Occupied Bandwidth	Pass
4	FCC Part 15.247(e)	Power Spectral Density	Pass
5	FCC Part 15.247(b)	Peak Output Power	Pass
6	FCC Part 15.247(d)	Out Of Band Emissions	Pass
7	FCC Part 15.247(d)	Conducted Spurious Emission	Pass
8	FCC Part 15.203	Antenna Requirement	Pass

1.2 TEST FACILITY

Test Firm : Shenzhen United Testing Technology Co., Ltd.
Address : 2F, Annex Bldg, Jiahuangyuan Tech Park, #365 Baotian 1 Rd, Tiegang Community, Xixiang Str, Bao'an District, Shenzhen, China

The testing quality ability of our laboratory meet with "Quality Law of People's Republic of China" Clause 19. The testing quality system of our laboratory meets with ISO/IEC-17025 requirements. This approval result is accepted by MRA of APLAC.

Our test facility is recognized, certified, or accredited by the following organizations:

A2LA Certificate Number: 4747.01

The EMC Laboratory has been accredited by A2LA, and in compliance with ISO/IEC 17025:2017 General Requirements for testing Laboratories.

IC Registration Number: 21947

The EMC Laboratory has been registered and fully described in a report filed with the (IC) Industry Canada.

1.3 MEASUREMENT UNCERTAINTY

The reported uncertainty of measurement $y \pm U$, where expanded uncertainty U is based on a standard uncertainty multiplied by a coverage factor of $k=2$, providing a level of confidence of approximately 95 %.

A. Conducted Measurement:

Test Site	Method	Measurement Frequency Range	U, (dB)
UNI	ANSI	9kHz ~ 150kHz	2.96
		150kHz ~ 30MHz	2.44

B. Radiated Measurement:

Test Site	Method	Measurement Frequency Range	U, (dB)
UNI	ANSI	9kHz ~ 30MHz	2.50
		30MHz ~ 1000MHz	4.80
		1000MHz ~ 18000MHz	4.13

C. RF Conducted Method:

Item	Measurement Uncertainty
Uncertainty of total RF power, conducted	$U_c = \pm 0.8$ dB
Uncertainty of RF power density, conducted	$U_c = \pm 2.6$ dB
Uncertainty of spurious emissions, conducted	$U_c = \pm 2$ %
Uncertainty of Occupied Channel Bandwidth	$U_c = \pm 2$ %

1.4 ENVIRONMENTAL CONDITIONS

During the measurement the environmental conditions were within the listed ranges:

Temperature:	15~35 °C
Relative Humidity:	30~60 %
Air Pressure:	950~1050 hPa

2 GENERAL INFORMATION

2.1 GENERAL DESCRIPTION OF EUT

Product:	Power Supply/Controller
Trade Name:	 <small>ATOMI SMART, Yunjin, Mlambert, Liquid leds, LITANG, Qllaa</small>
Main Model:	YJ-100
Additional Model:	N/A
Model Difference:	N/A
FCC ID:	2A2QEYJ-100
Operation Frequency:	802.11b/g/n20:2412~2462MHz 802.11n40: 2422~2452MHz
Number of Channels:	802.11b/g/n20: 11CH 802.11n40: 7CH
Modulation Type:	CCK, OFDM, DBPSK, DAPSK
Antenna Type:	PCB Antenna
Antenna Gain:	2.21dBi
Battery:	N/A
Adapter:	N/A
Power Source:	AC 120(240)V/60Hz

2.2 CARRIER FREQUENCY OF CHANNELS

Channel List for 802.11b/g/n(HT20)							
Channel	Frequency (MHz)	Channel	Frequency (MHz)	Channel	Frequency (MHz)	Channel	Frequency (MHz)
01	2412	04	2427	07	2442	10	2457
02	2417	05	2432	08	2447	11	2462
03	2422	06	2437	09	2452		

Channel List for 802.11n(40MHz)							
Channel	Frequency (MHz)	Channel	Frequency (MHz)	Channel	Frequency (MHz)	Channel	Frequency (MHz)
03	2422	05	2432	07	2442	09	2452
04	2427	06	2437	08	2447		

2.3 TEST MODE

The EUT was programmed to be in continuously transmitting mode.

Channel List for 802.11b/g/n((HT20)		
Test Channel	EUT Channel	Test Frequency (MHz)
Low	CH01	2412
Middle	CH06	2437
High	CH11	2462

Channel List for 802.11n(40MHz)		
Test Channel	EUT Channel	Test Frequency (MHz)
Low	CH03	2422
Middle	CH06	2437
High	CH09	2452

2.4 DESCRIPTION OF THE TEST MODES

During the measurement the environmental conditions were within the listed ranges:

Voltage	Normal Voltage	AC 120V
	High Voltage	AC 132V
	Low Voltage	AC 108V
Other	Normal Temperature	24°C
	Relative Humidity	55 %
	Air Pressure	989 hPa

Note: All modes were test at Normal Voltage, High Voltage, and Low Voltage, only the worst results of Normal Voltage was reported in the test report.

2.5 TEST SETUP

Operation of EUT during Conducted and Radiation testing:

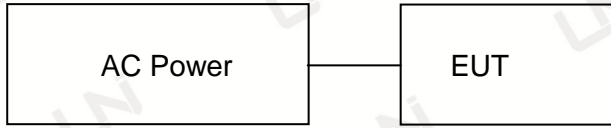

2.6 DESCRIPTION TEST PERIPHERAL AND EUT PERIPHERAL

The EUT has been tested as an independent unit together with other necessary accessories or support units. The following support units or accessories were used to form a representative test configuration during the tests.

Item	Equipment	Model No.	ID or Specification	Cable Length(cm)	Remark
1	Power Supply/Controller	YJ-100	2A2QEYJ-100	--	EUT

Note:

1. The support equipment was authorized by Declaration of Confirmation.
2. All the above equipment/cables were placed in worse case positions to maximize emission signals during emission test.

2.7 MEASUREMENT INSTRUMENTS LIST

Item	Equipment	Manufacturer	Model No.	Serial No.	Calibrated until
Conduction Emissions Measurement					
1	Conducted Emission Test Software	EZ-EMC	Ver.CCS-3A1-C E	N/A	N/A
2	AMN	Schwarzbeck	NNLK8121	8121370	2023.09.22
3	AAN	TESEQ	T8-Cat6	38888	2023.09.22
4	Pulse Limiter	CYBRTEK	EM5010	E115010056	2023.05.17
5	EMI Test Receiver	Rohde&Schwarz	ESCI	101210	2023.09.22
Radiated Emissions Measurement					
1	Radiated Emission Test Software	EZ-EMC	Ver.CCS-03A1	N/A	N/A
2	Horn Antenna	Sunol	DRH-118	A101415	2023.09.27
3	Broadband Hybrid Antenna	Sunol	JB1	A090215	2024.02.26
4	PREAMP	HP	8449B	3008A00160	2023.09.22
5	PREAMP	HP	8447D	2944A07999	2023.05.17
6	EMI TEST RECEIVER	Rohde&Schwarz	ESR3	101891	2023.09.22
7	VECTOR Signal Generator	Rohde&Schwarz	SMU200A	101521	2023.09.22
8	Signal Generator	Agilent	E4421B	MY4335105	2023.09.22
9	MXA Signal Analyzer	Agilent	N9020A	MY50510140	2023.09.22
10	MXA Signal Analyzer	Keysight	N9020A	MY51110104	2023.09.22
11	RF Power sensor	DARE	RPR3006W	15I00041SNO88	2023.05.17
12	RF Power sensor	DARE	RPR3006W	15I00041SNO89	2023.05.17
13	RF power divider	Anritsu	K241B	992289	2023.09.22
14	Wideband radio communication tester	Rohde&Schwarz	CMW500	154987	2023.09.22
15	Active Loop Antenna	Com-Power	AL-130R	10160009	2023.07.25
16	Broadband Hybrid Antennas	Schwarzbeck	VULB9163	VULB9163#958	2023.09.22
17	Horn Antenna	Schwarzbeck	BBHA9120D	9120D-1680	2023.05.23
18	Horn Antenna	A-INFOMW	LB-180400-KF	J211060660	2023.09.27
19	Microwave Broadband Preamplifier	Schwarzbeck	BBV 9721	100472	2023.09.22
20	Signal Generator	Agilent	N5183A	MY47420153	2023.09.22
21	Spectrum Analyzer	Rohde&Schwarz	FSP 40	100501	2023.09.22
22	Power Meter	KEYSIGHT	N1911A	MY50520168	2023.09.22
23	Frequency Meter	VICTOR	VC2000	997406086	2023.09.22
24	DC Power Source	HYELEC	HY5020E	055161818	2023.09.22

3 CONDUCTED EMISSION

3.1 TESTLIMIT

For unintentional device, according to § 15.207(a) Line Conducted Emission Limits is as following

Frequency (MHz)	Maximum RF Line Voltage (dB μ V)			
	CLASS A		CLASS B	
	Q.P.	Ave.	Q.P.	Ave.
0.15~0.50	79	66	66~56*	56~46*
0.50~5.00	73	60	56	46
5.00~30.0	73	60	60	50

* Decreasing linearly with the logarithm of the frequency.

For intentional device, according to §15.207(a) Line Conducted Emission Limit is same as above table.

3.2 TEST SETUP

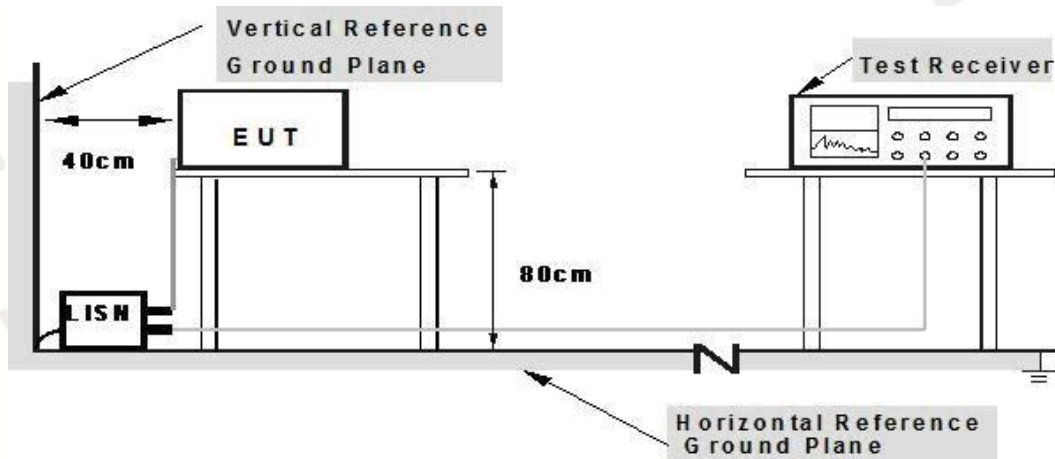

- Note: 1.Support units were connected to second LISN.**
2.Both of LISNs (A&N) are 80 cm from EUT and at least 80 from other units and other metal planes

3.3 TEST PROCEDURE

1. The equipment was set up as per the test configuration to simulate typical actual usage per the user's manual. The EUT is placed on a wooden table with a height of 0.8 meters is used and is placed on the ground plane as per ANSI C63.10.
2. Support equipment, if needed, was placed as per ANSI C63.10.
3. All I/O cables were positioned to simulate typical actual usage as per ANSI C63.10.
4. If a EUT received DC power from the USB Port of Notebook PC, the PC's adapter received AC120V/60Hzpower through a Line Impedance Stabilization Network (LISN) which supplied power source and was grounded to the ground plane.
5. All support equipments received AC power from a second LISN, if any.
6. The EUT test program was started. Emissions were measured on each current carrying line of the EUT using a spectrum Analyzer / Receiver connected to the LISN powering the EUT. The LISN has two monitoring points: Line 1 (Hot Side) and Line 2 (Neutral Side). Two scans were taken: one with Line 1connected to Analyzer / Receiver and Line 2 connected to a 50 ohm load; the second scan had Line 1connected to a 50 ohm load and Line 2 connected to the Analyzer / Receiver.
7. Analyzer / Receiver scanned from 150 kHz to 30MHz for emissions in each of the test modes.

3.4 TEST RESULT

PASS

Remark:

1. All modes were tested at AC 120V and 240V, only the worst result of AC 120V was reported.
2. All modes were test at Low, Middle, and High channel, only the worst result of 802.11g Low Channel was reported.

Temperature:	24°C	Relative Humidity:	48%
Test Date:	Oct. 17, 2022	Pressure:	1010hPa
Test Voltage:	AC 120V, 60Hz	Phase:	Line
Test Mode:	Transmitting mode of 802.11g 2412MHz		

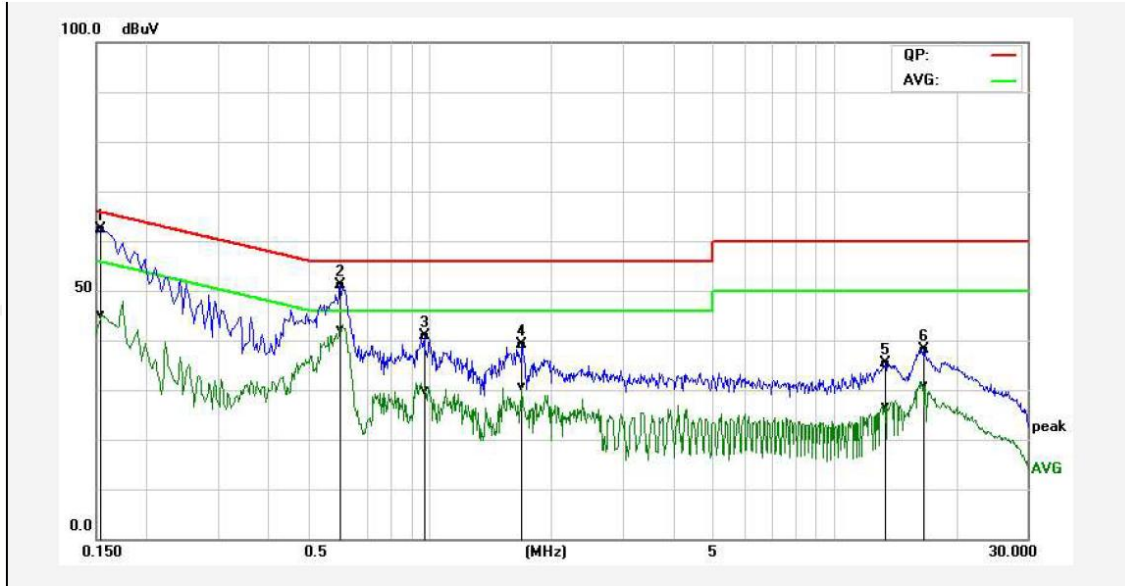

No.	Frequency (MHz)	QuasiPeak reading (dBuV)	Average reading (dBuV)	Correction factor (dB)	QuasiPeak result (dBuV)	Average result (dBuV)	QuasiPeak limit (dBuV)	Average limit (dBuV)	QuasiPeak margin (dB)	Average margin (dB)	Remark
1*	0.1540	52.22	34.94	10.12	62.34	45.06	65.78	55.78	-3.44	-10.72	Pass
2P	0.6020	41.07	31.95	10.08	51.15	42.03	56.00	46.00	-4.85	-3.97	Pass
3P	0.9700	30.79	19.86	10.12	40.91	29.98	56.00	46.00	-15.09	-16.02	Pass
4P	1.6900	28.94	20.44	10.11	39.05	30.55	56.00	46.00	-16.95	-15.45	Pass
5P	13.3420	25.12	16.46	10.21	35.33	26.67	60.00	50.00	-24.67	-23.33	Pass
6P	16.5900	27.80	20.51	10.34	38.14	30.85	60.00	50.00	-21.86	-19.15	Pass

Remark: Factor = Insertion Loss + Cable Loss, Result = Reading + Factor, Margin = Result – Limit.

Temperature:	24°C	Relative Humidity:	48%
Test Date:	Oct. 17, 2022	Pressure:	1010hPa
Test Voltage:	AC 120V, 60Hz	Phase:	Neutral
Test Mode:	Transmitting mode of 802.11g 2412MHz		

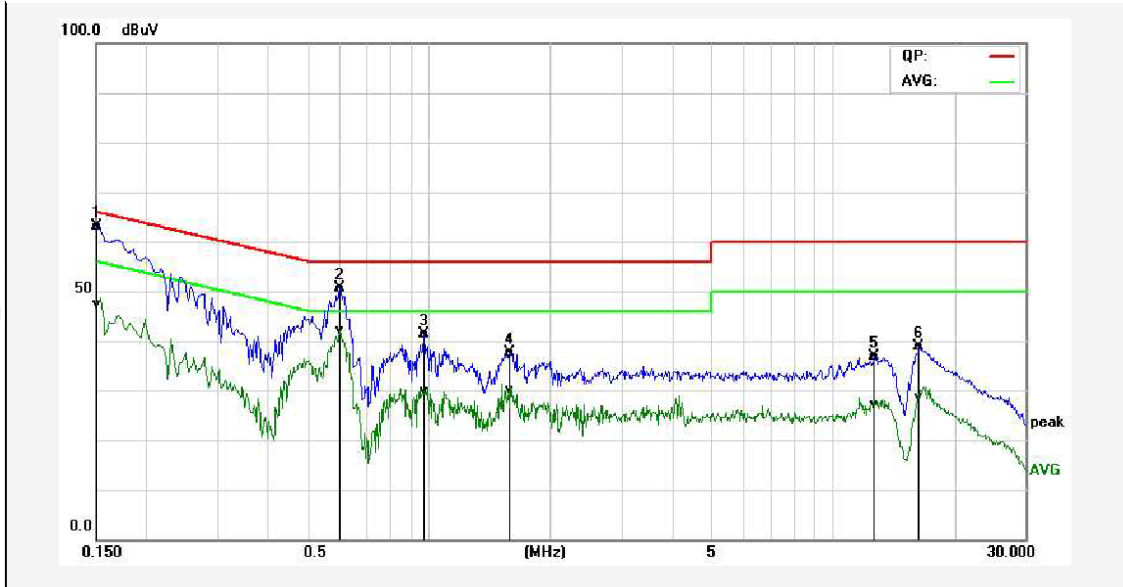

No.	Frequency (MHz)	QuasiPeak reading (dBuV)	Average reading (dBuV)	Correction factor (dB)	QuasiPeak result (dBuV)	Average result (dBuV)	QuasiPeak limit (dBuV)	Average limit (dBuV)	QuasiPeak margin (dB)	Average margin (dB)	Remark
1*	0.1500	52.97	37.25	10.12	63.09	47.37	66.00	56.00	-2.91	-8.63	Pass
2P	0.6020	40.65	32.12	10.08	50.73	42.20	56.00	46.00	-5.27	-3.80	Pass
3P	0.9740	31.25	19.85	10.12	41.37	29.97	56.00	46.00	-14.63	-16.03	Pass
4P	1.5780	27.51	20.04	10.12	37.63	30.16	56.00	46.00	-18.37	-15.84	Pass
5P	12.6820	26.74	16.81	10.20	36.94	27.01	60.00	50.00	-23.06	-22.99	Pass
6P	16.3660	28.45	18.24	10.32	38.77	28.56	60.00	50.00	-21.23	-21.44	Pass

Remark: Factor = Insertion Loss + Cable Loss, Result = Reading + Factor, Margin = Result – Limit.

4 RADIATED EMISSION

4.1 TESTLIMIT

For unintentional device, according to §15.209(a), except for Class A digital devices, the field strength of radiated emissions from unintentional radiators at a distance of 3 meters shall not exceed the following values:

Frequency	Field strength (microvolt/meter)	Limit (dBuV/m)	Remark	Measurement distance (m)
0.009MHz-0.490MHz	2400/F (kHz)	-	Quasi-peak	300
0.490MHz-1.705MHz	24000/F (kHz)	-	Quasi-peak	30
1.705MHz-30MHz	30	-	Quasi-peak	30
30MHz-88MHz	100	40.0	Quasi-peak	3
88MHz-216MHz	150	43.5	Quasi-peak	3
216MHz-960MHz	200	46.0	Quasi-peak	3
960MHz-1GHz	500	54.0	Quasi-peak	3
Above 1GHz	500	54.0	Average	3
		74.0	Peak	3

Limit calculation and transfer to 3m distance as showed in the following table:

Frequency (MHz)	Limit (dBuV/m)	Distance (m)
0.009-0.490	$20\log(2400/F(KHz))+40\log(300/3)$	3
0.490-1.705	$20\log(24000/F(KHz))+40\log(30/3)$	3
1.705-30.0	69.5	3
30-88	40.0	3
88-216	43.5	3
216-960	46.0	3
Above 960	54.0	3

For intentional device, according to §15.209(a), the general requirement of field strength of radiated emissions from intentional radiators at a distance of 3 meters shall not exceed the above table.

4.2 TEST SETUP

1. Radiated Emission Test-Up Frequency Below 30MHz

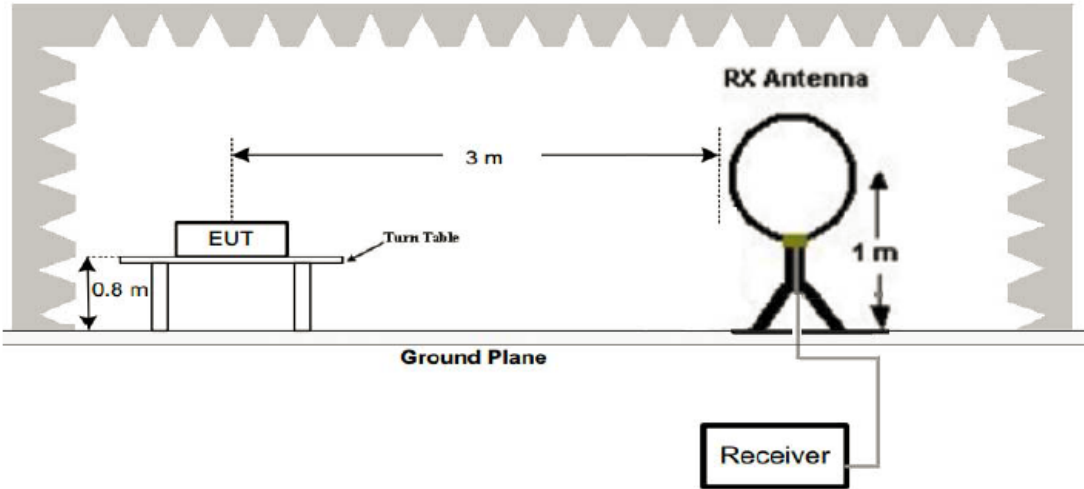

2. Radiated Emission Test-Up Frequency 30MHz~1GHz

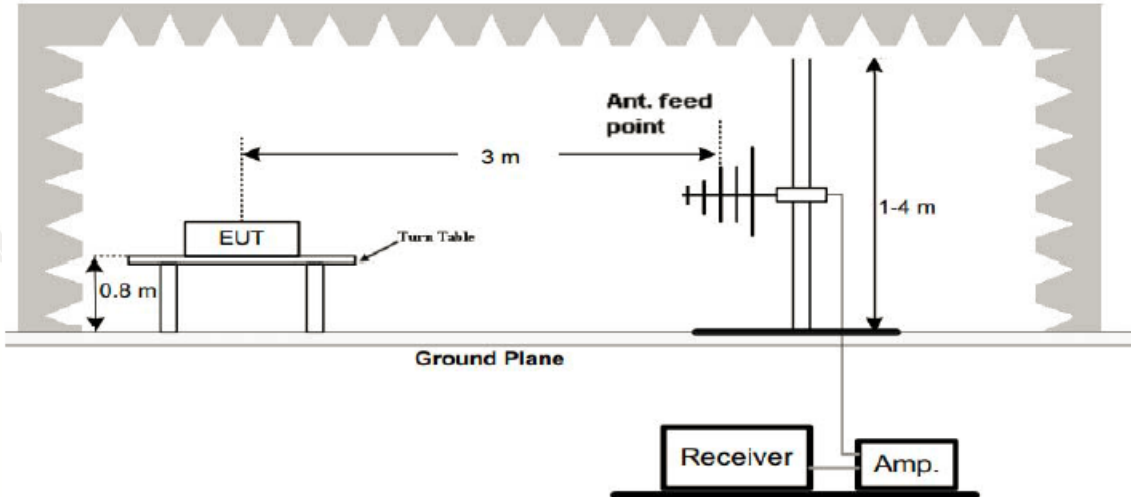

3. Radiated Emission Test-Up Frequency Above 1GHz

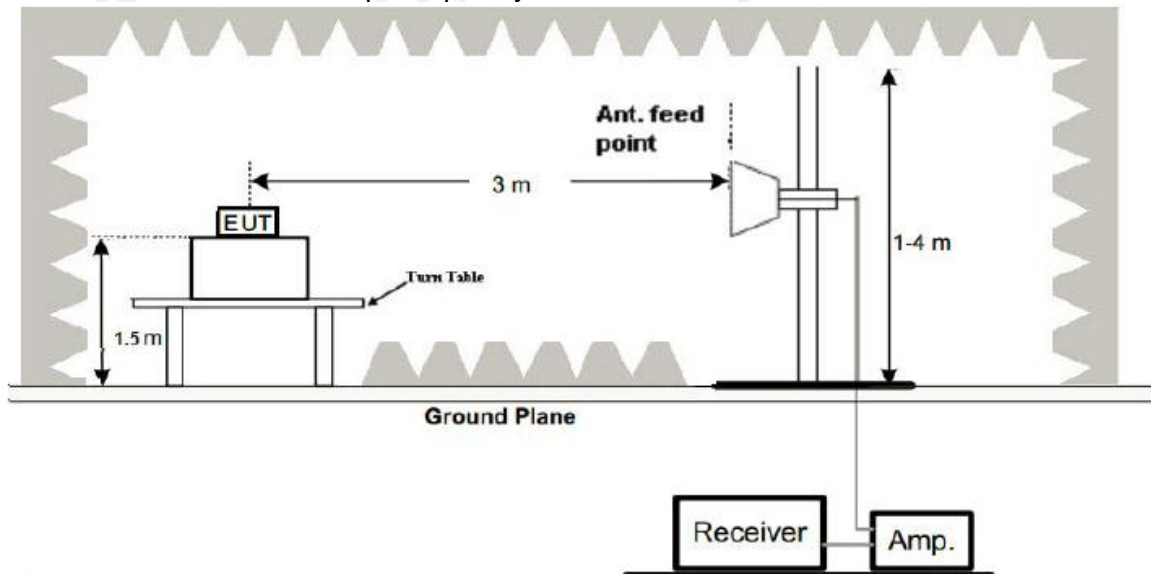

4.3 TEST PROCEDURE

1. Below 1GHz measurement the EUT is placed on turntable which is 0.8m above ground plane. And above 1GHz measurement EUT was placed on low permittivity and low tangent turn table which is 1.5m above ground plane.
2. The turntable shall be rotated for 360 degrees to determine the position of maximum emission level.
3. EUT is set 3m away from the receiving antenna, which is varied from 1m to 4m to find out the highest emissions.
4. Maximum procedure was performed on the six highest emissions to ensure EUT compliance.
5. And also, each emission was to be maximized by changing the polarization of receiving antenna both horizontal and vertical.
6. Repeat above procedures until the measurements for all frequencies are complete.
7. The test frequency range from 9kHz to 25GHz per FCC PART 15.33(a).

Note: For battery operated equipment, the equipment tests shall be performed using a new battery.

4.4 TEST RESULT

PASS

Remark:

1. All modes were test at Low, Middle, and High channel, only the worst result of 802.11g Low Channel was reported for below 1GHz test.
2. By preliminary testing and verifying three axis (X, Y and Z) position of EUT transmitted status, it was found that "X axis" position was the worst, and test data recorded in this report.

Below 1GHz Test Results:

Temperature:	24°C	Relative Humidity:	48%
Test Date:	Oct. 17, 2022	Pressure:	1010hPa
Test Voltage:	AC 120V, 60Hz	Phase:	Horizontal
Test Mode:	Transmitting mode of 802.11g 2412MHz		

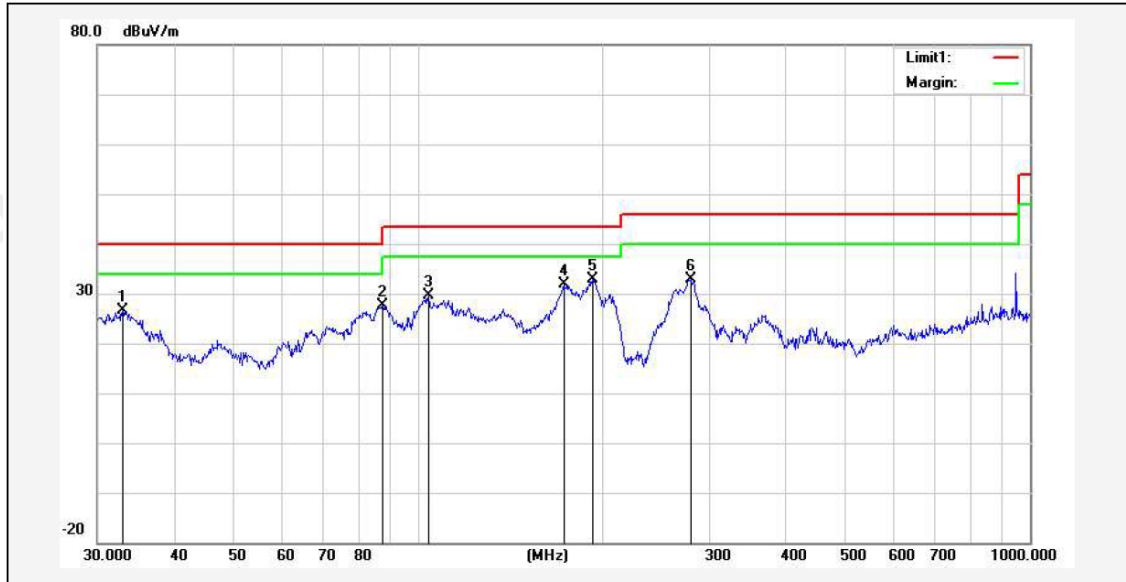

No.	Frequency (MHz)	Reading (dBuV)	Correction factor(dB/m)	Result (dBuV/m)	Limit (dBuV/m)	Margin (dB)	Degree (deg.)	Height (cm)	Remark
1	32.9791	35.89	-9.34	26.55	40.00	-13.45	60	100	peak
2	87.7248	48.41	-20.77	27.64	40.00	-12.36	70	100	peak
3	104.1701	47.92	-18.37	29.55	43.50	-13.95	80	100	peak
4	173.2051	48.92	-17.15	31.77	43.50	-11.73	120	100	peak
5*	193.0945	50.15	-17.27	32.88	43.50	-10.62	150	100	peak
6	280.0237	47.63	-14.75	32.88	46.00	-13.12	180	100	peak

Remark: Absolute Level= Reading Level+ Factor, Margin= Absolute Level – Limit
 Factor=Ant. Factor + Cable Loss – Pre-amplifier

Temperature:	24°C	Relative Humidity:	48%
Test Date:	Oct. 17, 2022	Pressure:	1010hPa
Test Voltage:	AC 120V, 60Hz	Phase:	Vertical
Test Mode:	Transmitting mode of 802.11g 2412MHz		

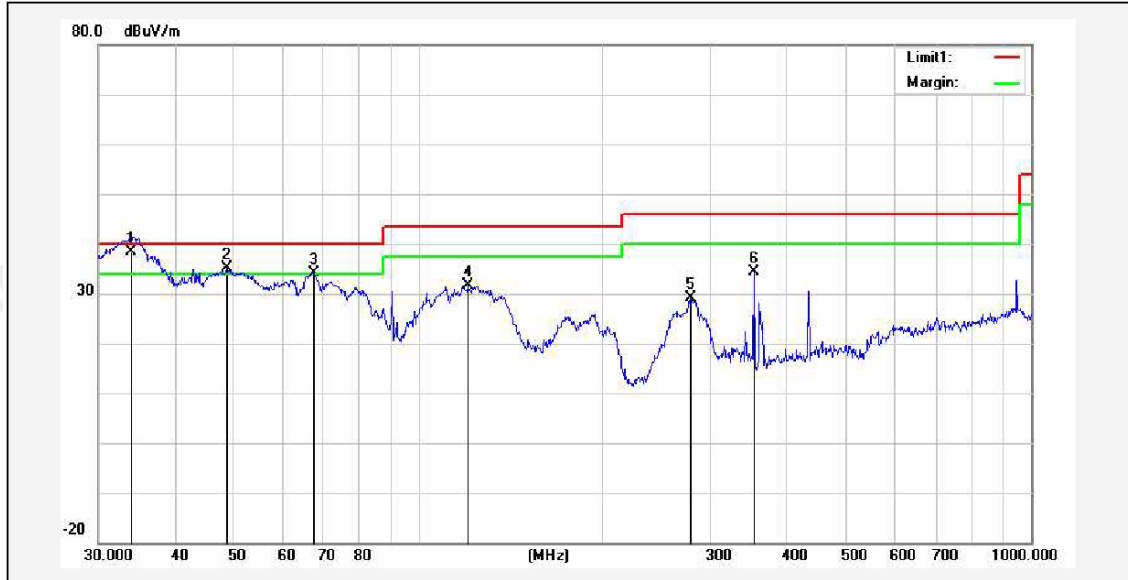

No.	Frequency (MHz)	Reading (dBuV)	Correction factor(dB/m)	Result (dBuV/m)	Limit (dBuV/m)	Margin (dB)	Degree (deg.)	Height (cm)	Remark
1*	33.9174	48.48	-10.06	38.42	40.00	-1.58	80	100	QP
2!	48.6720	54.89	-19.71	35.18	40.00	-4.82	100	100	peak
3!	67.4382	55.22	-20.99	34.23	40.00	-5.77	120	100	peak
4	120.2766	47.99	-16.31	31.68	43.50	-11.82	160	100	peak
5	278.0668	43.83	-14.76	29.07	46.00	-16.93	180	100	peak
6	352.9433	48.38	-13.94	34.44	46.00	-11.56	200	100	peak

Remark: Absolute Level= Reading Level+ Factor, Margin= Absolute Level – Limit
 Factor=Ant. Factor + Cable Loss – Pre-amplifier

Remark:

1. Radiated emission test from 9KHz to 10th harmonic of fundamental was verified, emission from 9kHz to 30MHz are more than 20dB below the limit, so it was not recorded in this report.
2. * denotes emission frequency which appearing within the Restricted Bands specified in provision of 15.205, then the general radiated emission limits in 15.209 apply.
3. The IF bandwidth of EMI Test Receiver between 30MHz to 1GHz was 120kHz, 1 MHz for measuring above 1 GHz, below 30MHz was 10kHz.

Above 1 GHz Test Results:

CH01 of 802.11b Mode (2412MHz):

Horizontal:

Frequency (MHz)	Reading Result (dBμV)	Factor (dB)	Emission Level (dBμV/m)	Limits (dBμV/m)	Margin (dB)	Detector Type
4824	60.94	-3.64	57.30	74	-16.70	PK
4824	50.18	-3.64	46.54	54	-7.46	AV
7236	57.51	-0.95	56.56	74	-17.44	PK
7236	47.26	-0.95	46.31	54	-7.69	AV

Remark: Factor = Antenna Factor + Cable Loss – Pre-amplifier. Margin = Absolute Level – Limit

Vertical:

Frequency (MHz)	Reading Result (dBμV)	Factor (dB)	Emission Level (dBμV/m)	Limits (dBμV/m)	Margin (dB)	Detector Type
4824	61.03	-3.64	57.39	74	-16.61	PK
4824	50.34	-3.64	46.70	54	-7.30	AV
7236	57.49	-0.95	56.54	74	-17.46	PK
7236	47.20	-0.95	46.25	54	-7.75	AV

Remark: Factor = Antenna Factor + Cable Loss – Pre-amplifier. Margin = Absolute Level – Limit

CH06 of 802.11b Mode (2437MHz):

Horizontal:

Frequency (MHz)	Reading Result (dBμV)	Factor (dB)	Emission Level (dBμV/m)	Limits (dBμV/m)	Margin (dB)	Detector Type
4874	60.75	-3.51	57.24	74	-16.76	PK
4874	50.12	-3.51	46.61	54	-7.39	AV
7311	57.36	-0.82	56.54	74	-17.46	PK
7311	47.00	-0.82	46.18	54	-7.82	AV

Remark: Factor = Antenna Factor + Cable Loss – Pre-amplifier. Margin = Absolute Level – Limit

Vertical:

Frequency (MHz)	Reading Result (dBμV)	Factor (dB)	Emission Level (dBμV/m)	Limits (dBμV/m)	Margin (dB)	Detector Type
4874	60.73	-3.51	57.22	74	-16.78	PK
4874	50.13	-3.51	46.62	54	-7.38	AV
7311	57.25	-0.82	56.43	74	-17.57	PK
7311	47.06	-0.82	46.24	54	-7.76	AV

Remark: Factor = Antenna Factor + Cable Loss – Pre-amplifier. Margin = Absolute Level – Limit

CH11 of 802.11b Mode (2462MHz):

Horizontal:

Frequency (MHz)	Reading Result (dBμV)	Factor (dB)	Emission Level (dBμV/m)	Limits (dBμV/m)	Margin (dB)	Detector Type
4924	60.57	-3.43	57.14	74	-16.86	PK
4924	50.12	-3.43	46.69	54	-7.31	AV
7386	57.33	-0.75	56.58	74	-17.42	PK
7386	47.10	-0.75	46.35	54	-7.65	AV

Remark: Factor = Antenna Factor + Cable Loss – Pre-amplifier. Margin = Absolute Level – Limit

Vertical:

Frequency (MHz)	Reading Result (dBμV)	Factor (dB)	Emission Level (dBμV/m)	Limits (dBμV/m)	Margin (dB)	Detector Type
4924	60.65	-3.43	57.22	74	-16.78	PK
4924	49.93	-3.43	46.50	54	-7.50	AV
7386	57.25	-0.75	56.50	74	-17.50	PK
7386	46.88	-0.75	46.13	54	-7.87	AV

Remark: Factor = Antenna Factor + Cable Loss – Pre-amplifier. Margin = Absolute Level – Limit

CH01 of 802.11g Mode (2412MHz):

Horizontal:

Frequency (MHz)	Reading Result (dBμV)	Factor (dB)	Emission Level (dBμV/m)	Limits (dBμV/m)	Margin (dB)	Detector Type
4824	60.20	-3.64	56.56	74	-17.44	PK
4824	50.14	-3.64	46.50	54	-7.50	AV
7236	56.78	-0.95	55.83	74	-18.17	PK
7236	46.93	-0.95	45.98	54	-8.02	AV

Remark: Factor = Antenna Factor + Cable Loss – Pre-amplifier. Margin = Absolute Level – Limit

Vertical:

Frequency (MHz)	Reading Result (dBμV)	Factor (dB)	Emission Level (dBμV/m)	Limits (dBμV/m)	Margin (dB)	Detector Type
4824	60.14	-3.64	56.50	74	-17.50	PK
4824	50.20	-3.64	46.56	54	-7.44	AV
7236	56.79	-0.95	55.84	74	-18.16	PK
7236	46.85	-0.95	45.90	54	-8.10	AV

Remark: Factor = Antenna Factor + Cable Loss – Pre-amplifier. Margin = Absolute Level – Limit

CH06 of 802.11g Mode (2437MHz):

Horizontal:

Frequency (MHz)	Reading Result (dBμV)	Factor (dB)	Emission Level (dBμV/m)	Limits (dBμV/m)	Margin (dB)	Detector Type
4874	60.12	-3.51	56.61	74	-17.39	PK
4874	49.85	-3.51	46.34	54	-7.66	AV
7311	56.68	-0.82	55.86	74	-18.14	PK
7311	46.70	-0.82	45.88	54	-8.12	AV

Remark: Factor = Antenna Factor + Cable Loss – Pre-amplifier. Margin = Absolute Level – Limit

Vertical:

Frequency (MHz)	Reading Result (dBμV)	Factor (dB)	Emission Level (dBμV/m)	Limits (dBμV/m)	Margin (dB)	Detector Type
4874	60.06	-3.51	56.55	74	-17.45	PK
4874	49.94	-3.51	46.43	54	-7.57	AV
7311	56.74	-0.82	55.92	74	-18.08	PK
7311	46.73	-0.82	45.91	54	-8.09	AV

Remark: Factor = Antenna Factor + Cable Loss – Pre-amplifier. Margin = Absolute Level – Limit

CH11 of 802.11g Mode (2462MHz):

Horizontal:

Frequency (MHz)	Reading Result (dBμV)	Factor (dB)	Emission Level (dBμV/m)	Limits (dBμV/m)	Margin (dB)	Detector Type
4924	60.06	-3.43	56.63	74	-17.37	PK
4924	49.81	-3.43	46.38	54	-7.62	AV
7386	56.55	-0.75	55.80	74	-18.20	PK
7386	46.60	-0.75	45.85	54	-8.15	AV

Remark: Factor = Antenna Factor + Cable Loss – Pre-amplifier. Margin = Absolute Level – Limit

Vertical:

Frequency (MHz)	Reading Result (dBμV)	Factor (dB)	Emission Level (dBμV/m)	Limits (dBμV/m)	Margin (dB)	Detector Type
4924	60.11	-3.43	56.68	74	-17.32	PK
4924	49.80	-3.43	46.37	54	-7.63	AV
7386	56.57	-0.75	55.82	74	-18.18	PK
7386	46.63	-0.75	45.88	54	-8.12	AV

Remark: Factor = Antenna Factor + Cable Loss – Pre-amplifier. Margin = Absolute Level – Limit

CH01 of 802.11n/HT20 Mode (2412MHz):

Horizontal:

Frequency (MHz)	Reading Result (dB μ V)	Factor (dB)	Emission Level (dB μ V/m)	Limits (dB μ V/m)	Margin (dB)	Detector Type
4824	60.14	-3.64	56.50	74	-17.50	PK
4824	49.79	-3.64	46.15	54	-7.85	AV
7236	56.51	-0.95	55.56	74	-18.44	PK
7236	46.57	-0.95	45.62	54	-8.38	AV

Remark: Factor = Antenna Factor + Cable Loss – Pre-amplifier. Margin = Absolute Level – Limit

Vertical:

Frequency (MHz)	Reading Result (dB μ V)	Factor (dB)	Emission Level (dB μ V/m)	Limits (dB μ V/m)	Margin (dB)	Detector Type
4824	60.09	-3.64	56.45	74	-17.55	PK
4824	49.82	-3.64	46.18	54	-7.82	AV
7236	56.62	-0.95	55.67	74	-18.33	PK
7236	46.47	-0.95	45.52	54	-8.48	AV

Remark: Factor = Antenna Factor + Cable Loss – Pre-amplifier. Margin = Absolute Level – Limit

CH06 of 802.11n/HT20 Mode (2437MHz):

Horizontal:

Frequency (MHz)	Reading Result (dBμV)	Factor (dB)	Emission Level (dBμV/m)	Limits (dBμV/m)	Margin (dB)	Detector Type
4874	59.89	-3.51	56.38	74	-17.62	PK
4874	49.75	-3.51	46.24	54	-7.76	AV
7311	56.36	-0.82	55.54	74	-18.46	PK
7311	46.32	-0.82	45.50	54	-8.50	AV

Remark: Factor = Antenna Factor + Cable Loss – Pre-amplifier. Margin = Absolute Level – Limit

Vertical:

Frequency (MHz)	Reading Result (dBμV)	Factor (dB)	Emission Level (dBμV/m)	Limits (dBμV/m)	Margin (dB)	Detector Type
4874	59.95	-3.51	56.44	74	-17.56	PK
4874	49.77	-3.51	46.26	54	-7.74	AV
7311	56.27	-0.82	55.45	74	-18.55	PK
7311	46.25	-0.82	45.43	54	-8.57	AV

Remark: Factor = Antenna Factor + Cable Loss – Pre-amplifier. Margin = Absolute Level – Limit

CH11of 802.11n/HT20 Mode (2462MHz):

Horizontal:

Frequency (MHz)	Reading Result (dB μ V)	Factor (dB)	Emission Level (dB μ V/m)	Limits (dB μ V/m)	Margin (dB)	Detector Type
4924	59.85	-3.43	56.42	74	-17.58	PK
4924	49.78	-3.43	46.35	54	-7.65	AV
7386	56.30	-0.75	55.55	74	-18.45	PK
7386	46.19	-0.75	45.44	54	-8.56	AV

Remark: Factor = Antenna Factor + Cable Loss – Pre-amplifier. Margin = Absolute Level – Limit

Vertical:

Frequency (MHz)	Reading Result (dB μ V)	Factor (dB)	Emission Level (dB μ V/m)	Limits (dB μ V/m)	Margin (dB)	Detector Type
4924	59.91	-3.43	56.48	74	-17.52	PK
4924	49.68	-3.43	46.25	54	-7.75	AV
7386	56.19	-0.75	55.44	74	-18.56	PK
7386	46.23	-0.75	45.48	54	-8.52	AV

Remark: Factor = Antenna Factor + Cable Loss – Pre-amplifier. Margin = Absolute Level – Limit

CH03 of 802.11n/H40 Mode (2422MHz):

Horizontal:

Frequency (MHz)	Reading Result (dBμV)	Factor (dB)	Emission Level (dBμV/m)	Limits (dBμV/m)	Margin (dB)	Detector Type
4844	59.82	-3.63	56.19	74	-17.81	PK
4844	49.73	-3.63	46.10	54	-7.90	AV
7266	56.25	-0.94	55.31	74	-18.69	PK
7266	46.18	-0.94	45.24	54	-8.76	AV

Remark: Factor = Antenna Factor + Cable Loss – Pre-amplifier. Margin = Absolute Level – Limit

Vertical:

Frequency (MHz)	Reading Result (dBμV)	Factor (dB)	Emission Level (dBμV/m)	Limits (dBμV/m)	Margin (dB)	Detector Type
4844	59.91	-3.63	56.28	74	-17.72	PK
4844	49.75	-3.63	46.12	54	-7.88	AV
7266	56.18	-0.94	55.24	74	-18.76	PK
7266	46.33	-0.94	45.39	54	-8.61	AV

Remark: Factor = Antenna Factor + Cable Loss – Pre-amplifier. Margin = Absolute Level – Limit

CH06 of 802.11n/H40 Mode (2437MHz):

Horizontal:

Frequency (MHz)	Reading Result (dB μ V)	Factor (dB)	Emission Level (dB μ V/m)	Limits (dB μ V/m)	Margin (dB)	Detector Type
4874	59.76	-3.51	56.25	74	-17.75	PK
4874	49.62	-3.51	46.11	54	-7.89	AV
7311	56.05	-0.82	55.23	74	-18.77	PK
7311	46.15	-0.82	45.33	54	-8.67	AV

Remark: Factor = Antenna Factor + Cable Loss – Pre-amplifier. Margin = Absolute Level – Limit

Vertical:

Frequency (MHz)	Reading Result (dB μ V)	Factor (dB)	Emission Level (dB μ V/m)	Limits (dB μ V/m)	Margin (dB)	Detector Type
4874	59.81	-3.51	56.30	74	-17.70	PK
4874	49.56	-3.51	46.05	54	-7.95	AV
7311	56.10	-0.82	55.28	74	-18.72	PK
7311	46.10	-0.82	45.28	54	-8.72	AV

Remark: Factor = Antenna Factor + Cable Loss – Pre-amplifier. Margin = Absolute Level – Limit

CH09 of 802.11n/H40 Mode (2452MHz):

Horizontal:

Frequency (MHz)	Reading Result (dBμV)	Factor (dB)	Emission Level (dBμV/m)	Limits (dBμV/m)	Margin (dB)	Detector Type
4904	59.63	-3.43	56.20	74	-17.80	PK
4904	49.51	-3.43	46.08	54	-7.92	AV
7356	56.05	-0.75	55.30	74	-18.70	PK
7356	46.07	-0.75	45.32	54	-8.68	AV

Remark: Factor = Antenna Factor + Cable Loss – Pre-amplifier. Margin = Absolute Level – Limit

Vertical:

Frequency (MHz)	Reading Result (dBμV)	Factor (dB)	Emission Level (dBμV/m)	Limits (dBμV/m)	Margin (dB)	Detector Type
4904	59.57	-3.43	56.14	74	-17.86	PK
4904	49.47	-3.43	46.04	54	-7.96	AV
7356	55.93	-0.75	55.18	74	-18.82	PK
7356	45.95	-0.75	45.20	54	-8.80	AV

Remark: Factor = Antenna Factor + Cable Loss – Pre-amplifier. Margin = Absolute Level – Limit

Remark:

1. Measuring frequencies from 1 GHz to the 25 GHz.
2. “F” denotes fundamental frequency; “H” denotes spurious frequency. “E” denotes band edge frequency.
3. * denotes emission frequency which appearing within the Restricted Bands specified in provision of 15.205, then the general radiated emission limits in 15.209 apply.
4. The emissions are attenuated more than 20dB below the permissible limits are not recorded in the report.
5. The IF bandwidth of EMI Test Receiver between 30MHz to 1GHz was 120kHz, 1 MHz for measuring above 1 GHz, below 30MHz was 10kHz. The resolution bandwidth of test receiver/spectrum analyzer is 1MHz and video bandwidth is 3MHz for peak measurement with peak detector at frequency above 1GHz. The resolution bandwidth of test receiver/spectrum analyzer is 1MHz and video bandwidth is 10Hz for Average measurement with peak detection at frequency above 1GHz.
6. When the test results of Peak Detected below the limits of Average Detected, the Average Detected is not need completed. For example: Top Channel at Fundamental 73.16dBuV/m(PK Value) <93.98(AV Limit), at harmonic 53.20 dBuV/m(PK Value) <54 dBuV/m(AV Limit), the Average Detected not need to completed.
7. All modes of operation were investigated and the worst-case emissions are reported.

Operation Mode: CH01 of 802.11b Mode (2412MHz)

Horizontal:

Frequency (MHz)	Reading Result (dBμV)	Factor (dB)	Emission Level (dBμV/m)	Limits (dBμV/m)	Margin (dB)	Detector Type
2310	57.09	-5.81	51.28	74	-22.72	PK
2310	/	-5.81	/	54	/	AV
2390	65.70	-5.84	59.86	74	-14.14	PK
2390	47.69	-5.84	41.85	54	-12.15	AV

Remark: Factor = Antenna Factor + Cable Loss – Pre-amplifier. Margin = Absolute Level – Limit

Vertical:

Frequency (MHz)	Reading Result (dBμV)	Factor (dB)	Emission Level (dBμV/m)	Limits (dBμV/m)	Margin (dB)	Detector Type
2310	57.44	-5.81	51.63	74	-22.37	PK
2310	/	-5.81	/	54	/	AV
2390	65.75	-5.84	59.91	74	-14.09	PK
2390	47.76	-5.84	41.92	54	-12.08	AV

Remark: Factor = Antenna Factor + Cable Loss – Pre-amplifier. Margin = Absolute Level – Limit

Operation Mode: CH11 of 802.11b Mode (2462MHz)

Horizontal:

Frequency (MHz)	Reading Result (dB μ V)	Factor (dB)	Emission Level (dB μ V/m)	Limits (dB μ V/m)	Margin (dB)	Detector Type
2483.5	57.13	-5.65	51.48	74	-22.52	PK
2483.5	/	-5.65	/	54	/	AV
2500	57.36	-5.72	51.64	74	-22.36	PK
2500	/	-5.72	/	54	/	AV

Remark: Factor = Antenna Factor + Cable Loss – Pre-amplifier. Margin = Absolute Level – Limit

Vertical:

Frequency (MHz)	Reading Result (dB μ V)	Factor (dB)	Emission Level (dB μ V/m)	Limits (dB μ V/m)	Margin (dB)	Detector Type
2483.5	57.29	-5.65	51.64	74	-22.36	PK
2483.5	/	-5.65	/	54	/	AV
2500	57.32	-5.72	51.60	74	-22.40	PK
2500	/	-5.72	/	54	/	AV

Remark: Factor = Antenna Factor + Cable Loss – Pre-amplifier. Margin = Absolute Level – Limit

Operation Mode: CH01 of 802.11g Mode (2412MHz)

Horizontal:

Frequency (MHz)	Reading Result (dB μ V)	Factor (dB)	Emission Level (dB μ V/m)	Limits (dB μ V/m)	Margin (dB)	Detector Type
2310	57.31	-5.81	51.50	74	-22.50	PK
2310	/	-5.81	/	54	/	AV
2390	65.74	-5.84	59.90	74	-14.10	PK
2390	47.68	-5.84	41.84	54	-12.16	AV

Remark: Factor = Antenna Factor + Cable Loss – Pre-amplifier. Margin = Absolute Level – Limit

Vertical:

Frequency (MHz)	Reading Result (dB μ V)	Factor (dB)	Emission Level (dB μ V/m)	Limits (dB μ V/m)	Margin (dB)	Detector Type
2310	57.37	-5.81	51.56	74	-22.44	PK
2310	/	-5.81	/	54	/	AV
2390	65.76	-5.84	59.92	74	-14.08	PK
2390	47.57	-5.84	41.73	54	-12.27	AV

Remark: Factor = Antenna Factor + Cable Loss – Pre-amplifier. Margin = Absolute Level – Limit

Operation Mode: CH11 of 802.11g Mode (2462MHz)

Horizontal:

Frequency (MHz)	Reading Result (dB μ V)	Factor (dB)	Emission Level (dB μ V/m)	Limits (dB μ V/m)	Margin (dB)	Detector Type
2483.5	57.13	-5.65	51.48	74	-22.52	PK
2483.5	/	-5.65	/	54	/	AV
2500	57.26	-5.72	51.54	74	-22.46	PK
2500	/	-5.72	/	54	/	AV

Remark: Factor = Antenna Factor + Cable Loss – Pre-amplifier. Margin = Absolute Level – Limit

Vertical:

Frequency (MHz)	Reading Result (dB μ V)	Factor (dB)	Emission Level (dB μ V/m)	Limits (dB μ V/m)	Margin (dB)	Detector Type
2483.5	57.08	-5.65	51.43	74	-22.57	PK
2483.5	/	-5.65	/	54	/	AV
2500	57.12	-5.72	51.40	74	-22.60	PK
2500	/	-5.72	/	54	/	AV

Remark: Factor = Antenna Factor + Cable Loss – Pre-amplifier. Margin = Absolute Level – Limit

Operation Mode: CH01 of 802.11n/HT20 Mode (2412MHz)

Horizontal:

Frequency (MHz)	Reading Result (dB μ V)	Factor (dB)	Emission Level (dB μ V/m)	Limits (dB μ V/m)	Margin (dB)	Detector Type
2310	57.25	-5.81	51.44	74	-22.56	PK
2310	/	-5.81	/	54	/	AV
2390	65.77	-5.84	59.93	74	-14.07	PK
2390	47.68	-5.84	41.84	54	-12.16	AV

Remark: Factor = Antenna Factor + Cable Loss – Pre-amplifier. Margin = Absolute Level – Limit

Vertical:

Frequency (MHz)	Reading Result (dB μ V)	Factor (dB)	Emission Level (dB μ V/m)	Limits (dB μ V/m)	Margin (dB)	Detector Type
2310	57.43	-5.81	51.62	74	-22.38	PK
2310	/	-5.81	/	54	/	AV
2390	65.76	-5.84	59.92	74	-14.08	PK
2390	47.75	-5.84	41.91	54	-12.09	AV

Remark: Factor = Antenna Factor + Cable Loss – Pre-amplifier. Margin = Absolute Level – Limit

Operation Mode: CH11 of 802.11n/HT20 Mode (2462MHz)

Horizontal:

Frequency (MHz)	Reading Result (dB μ V)	Factor (dB)	Emission Level (dB μ V/m)	Limits (dB μ V/m)	Margin (dB)	Detector Type
2483.5	57.13	-5.65	51.48	74	-22.52	PK
2483.5	/	-5.65	/	54	/	AV
2500	57.36	-5.72	51.64	74	-22.36	PK
2500	/	-5.72	/	54	/	AV

Remark: Factor = Antenna Factor + Cable Loss – Pre-amplifier. Margin = Absolute Level – Limit

Vertical:

Frequency (MHz)	Reading Result (dB μ V)	Factor (dB)	Emission Level (dB μ V/m)	Limits (dB μ V/m)	Margin (dB)	Detector Type
2483.5	57.25	-5.65	51.60	74	-22.40	PK
2483.5	/	-5.65	/	54	/	AV
2500	57.45	-5.72	51.73	74	-22.27	PK
2500	/	-5.72	/	54	/	AV

Remark: Factor = Antenna Factor + Cable Loss – Pre-amplifier. Margin = Absolute Level – Limit

CH03 of 802.11n/H40 Mode (2422MHz)

Horizontal:

Frequency (MHz)	Reading Result (dBμV)	Factor (dB)	Emission Level (dBμV/m)	Limits (dBμV/m)	Margin (dB)	Detector Type
2310	57.33	-5.81	51.52	74	-22.48	PK
2310	/	-5.81	/	54	/	AV
2390	65.72	-5.84	59.88	74	-14.12	PK
2390	47.69	-5.84	41.85	54	-12.15	AV

Remark: Factor = Antenna Factor + Cable Loss – Pre-amplifier. Margin = Absolute Level – Limit

Vertical:

Frequency (MHz)	Reading Result (dBμV)	Factor (dB)	Emission Level (dBμV/m)	Limits (dBμV/m)	Margin (dB)	Detector Type
2310	57.29	-5.81	51.48	74	-22.52	PK
2310	/	-5.81	/	54	/	AV
2390	65.67	-5.84	59.83	74	-14.17	PK
2390	47.72	-5.84	41.88	54	-12.12	AV

Remark: Factor = Antenna Factor + Cable Loss – Pre-amplifier. Margin = Absolute Level – Limit

CH09 of 802.11n/H40 Mode (2452MHz)

Horizontal:

Frequency (MHz)	Reading Result (dBμV)	Factor (dB)	Emission Level (dBμV/m)	Limits (dBμV/m)	Margin (dB)	Detector Type
2483.5	57.08	-5.65	51.43	74	-22.57	PK
2483.5	/	-5.65	/	54	/	AV
2500	57.39	-5.72	51.67	74	-22.33	PK
2500	/	-5.72	/	54	/	AV

Remark: Factor = Antenna Factor + Cable Loss – Pre-amplifier. Margin = Absolute Level – Limit

Vertical:

Frequency (MHz)	Reading Result (dBμV)	Factor (dB)	Emission Level (dBμV/m)	Limits (dBμV/m)	Margin (dB)	Detector Type
2483.5	57.45	-5.65	51.80	74	-22.20	PK
2483.5	/	-5.65	/	54	/	AV
2500	57.12	-5.72	51.40	74	-22.60	PK
2500	/	-5.72	/	54	/	AV

Remark: Factor = Antenna Factor + Cable Loss – Pre-amplifier. Margin = Absolute Level – Limit

5 OCCUPIED BANDWIDTH

5.1 TESTLIMIT

FCC Part15(15.247), Subpart C				
Section	Test Item	Limit	Frequency Range (MHz)	Result
15.247(a)(2)	Bandwidth	$\geq 500\text{KHz}$ (6dB bandwidth)	2400-2483.5	PASS

5.2 TEST PROCEDURE

1. The EUT was placed on a turn table which is 0.8m above ground plane.
2. Set EUT as normal operation.
3. Based on FCC Part15 C Section 15.247: RBW=100kHz, VBW=300kHz.
4. The useful radiated emission from the EUT was detected by the spectrum analyzer with peak detector.

5.3 EQUIPMENT USED

Same as Radiated Emission Measurement.

5.4 TEST RESULT

PASS

TX 802.11b Mode			
Frequency (MHz)	6dB Bandwidth (MHz)	Channel Separation (kHz)	Result
2412	9.994	>=500	PASS
2437	10.99	>=500	PASS
2462	11.08	>=500	PASS

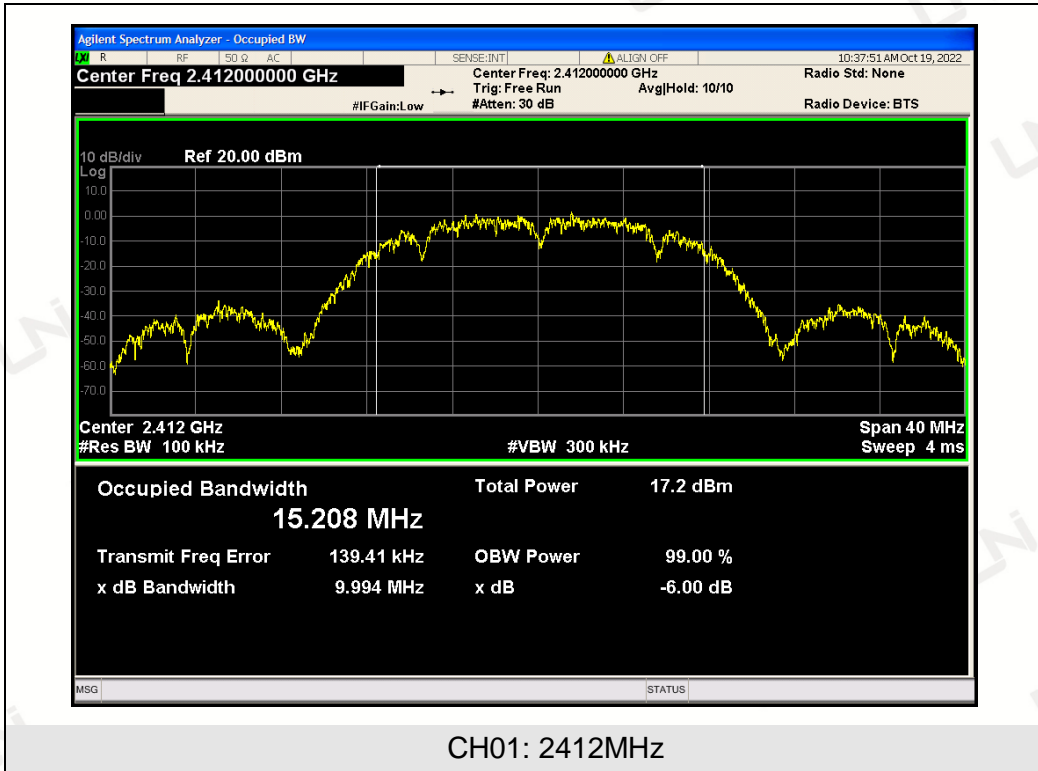

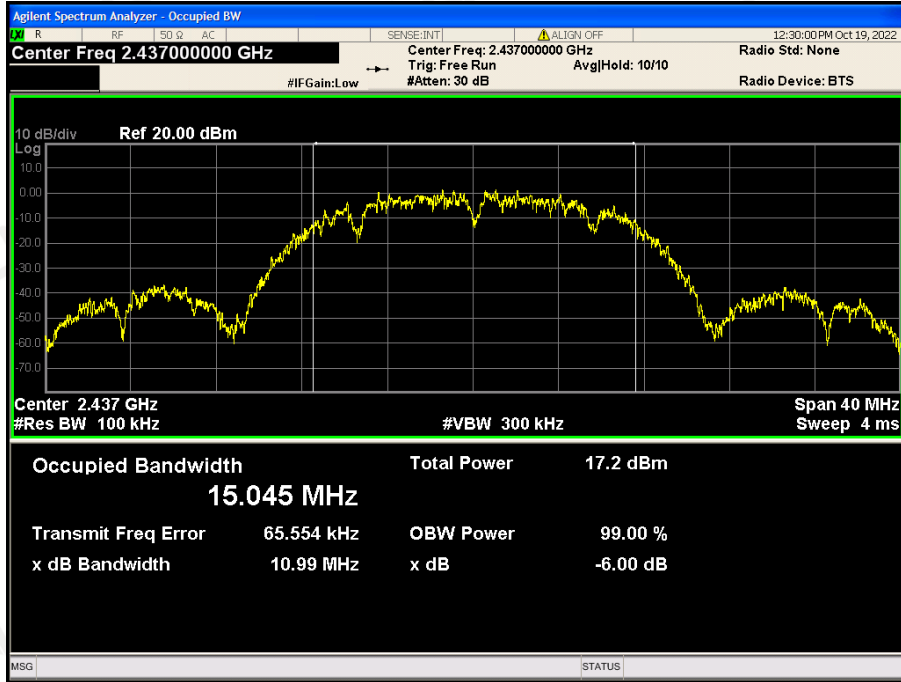

CH06: 2437MHz

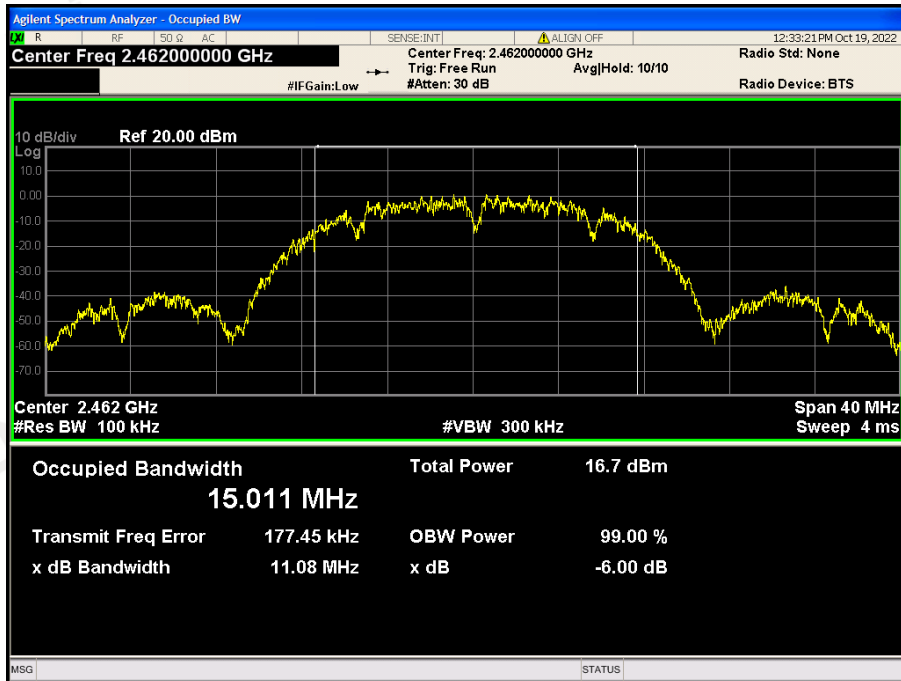

CH11: 2462MHz

TX 802.11g Mode			
Frequency (MHz)	6dB Bandwidth (MHz)	Channel Separation (kHz)	Result
2412	14.05	>=500	PASS
2437	15.34	>=500	PASS
2462	13.75	>=500	PASS

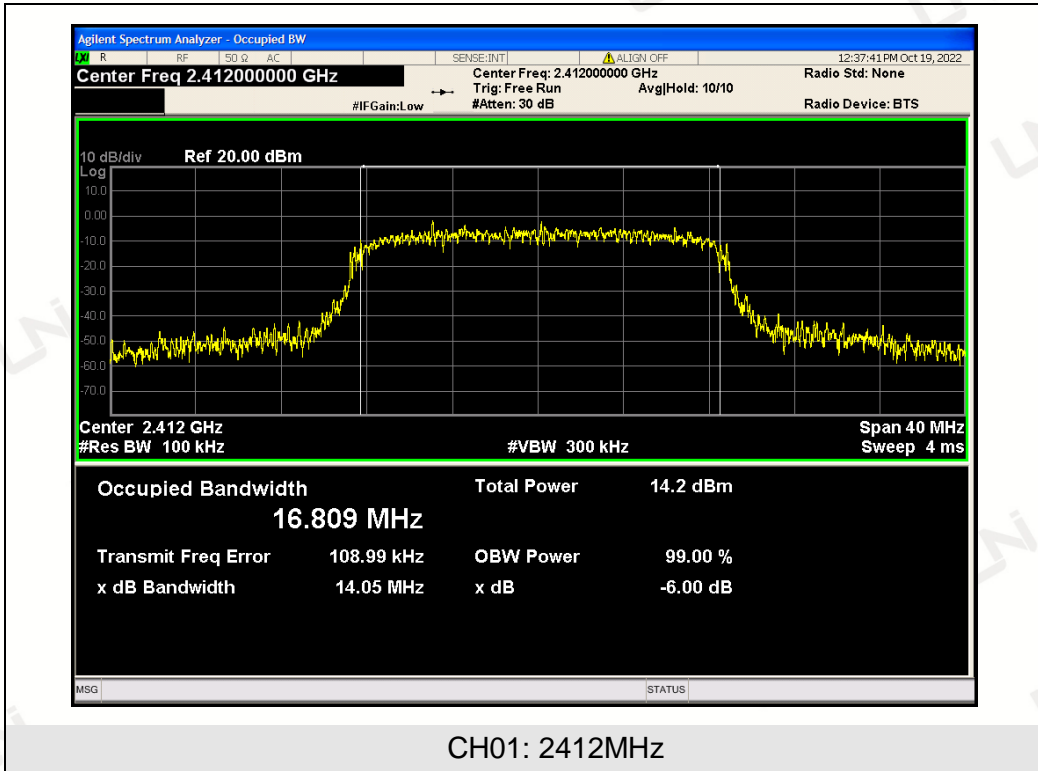

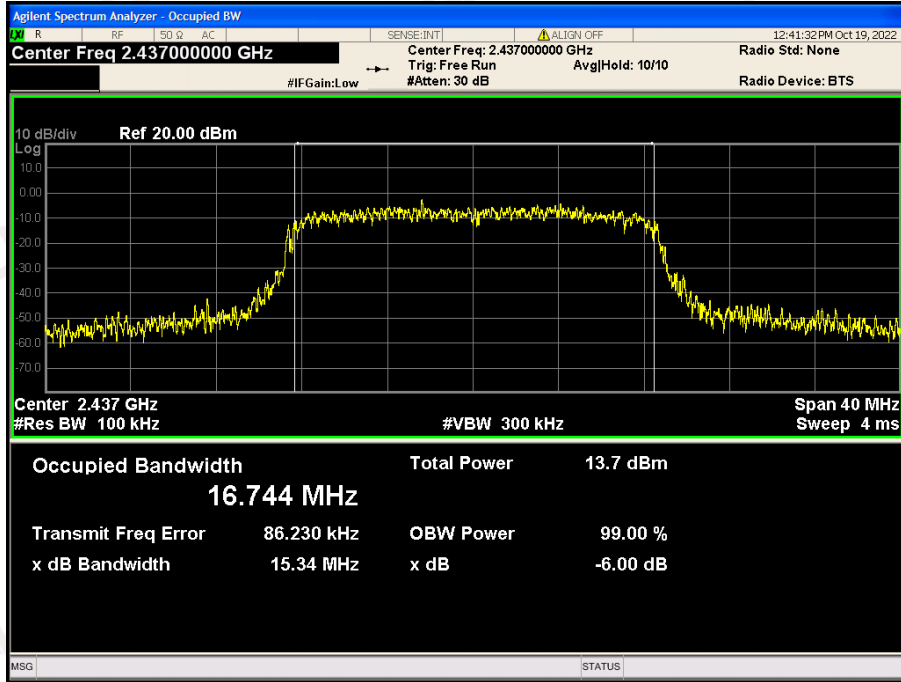

CH06: 2437MHz

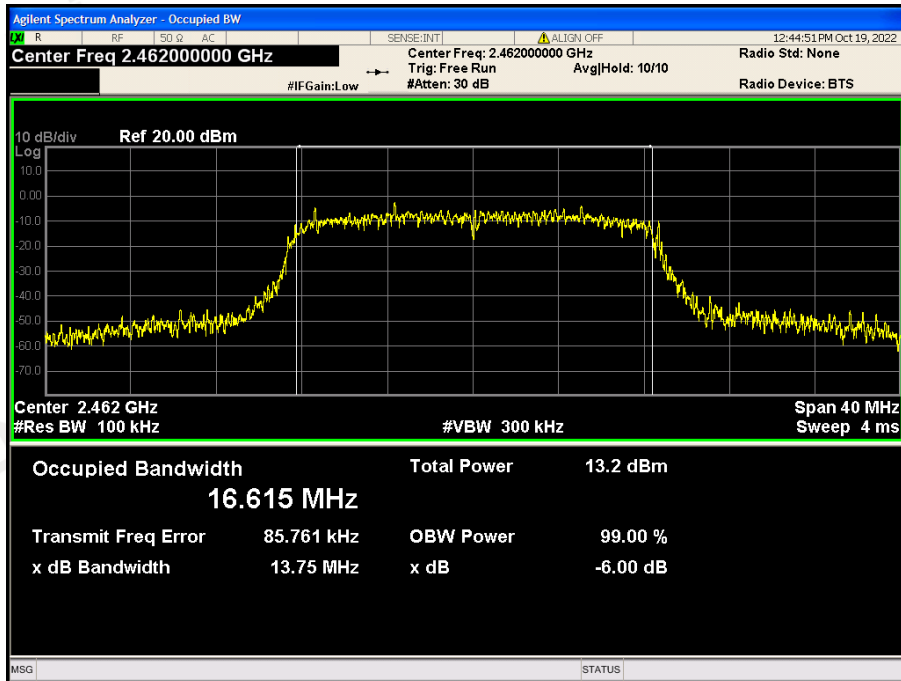

CH11: 2462MHz

TX 802.11n/HT20 Mode			
Frequency (MHz)	6dB Bandwidth (MHz)	Channel Separation (kHz)	Result
2412	15.09	>=500	PASS
2437	16.56	>=500	PASS
2462	15.04	>=500	PASS

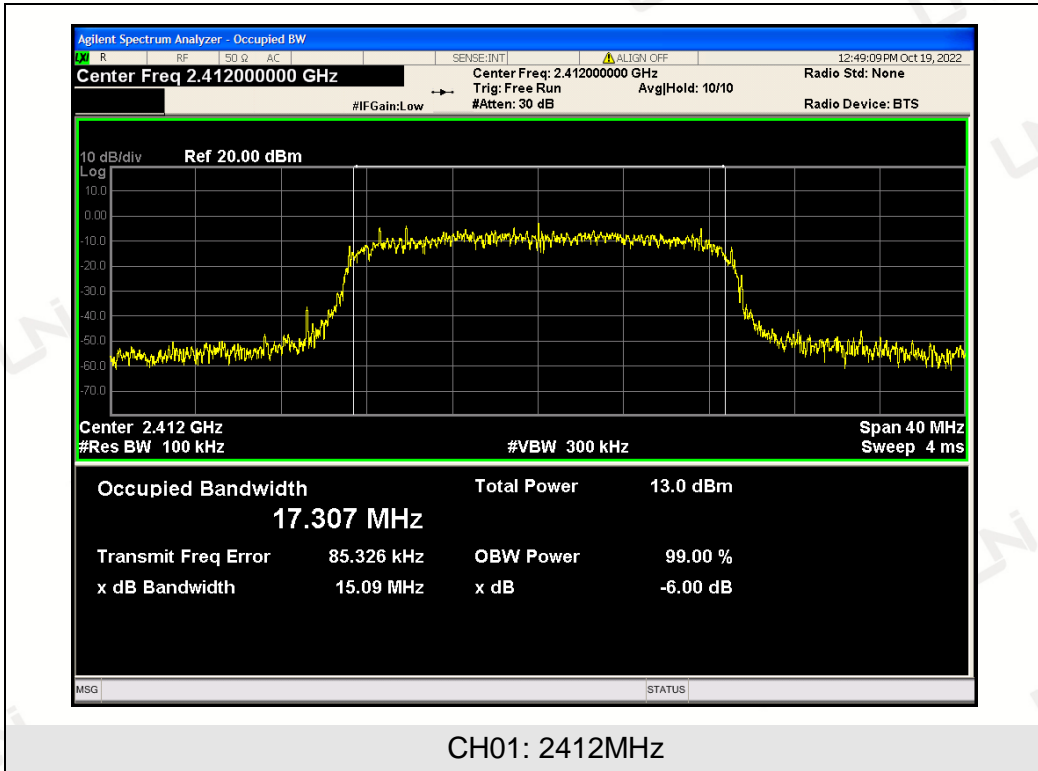

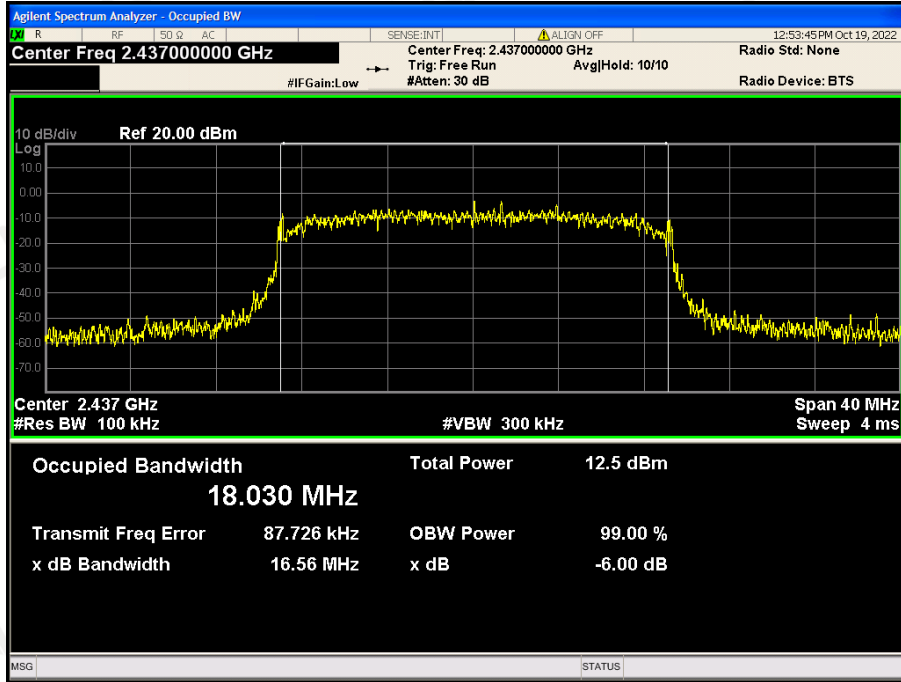

CH06: 2437MHz

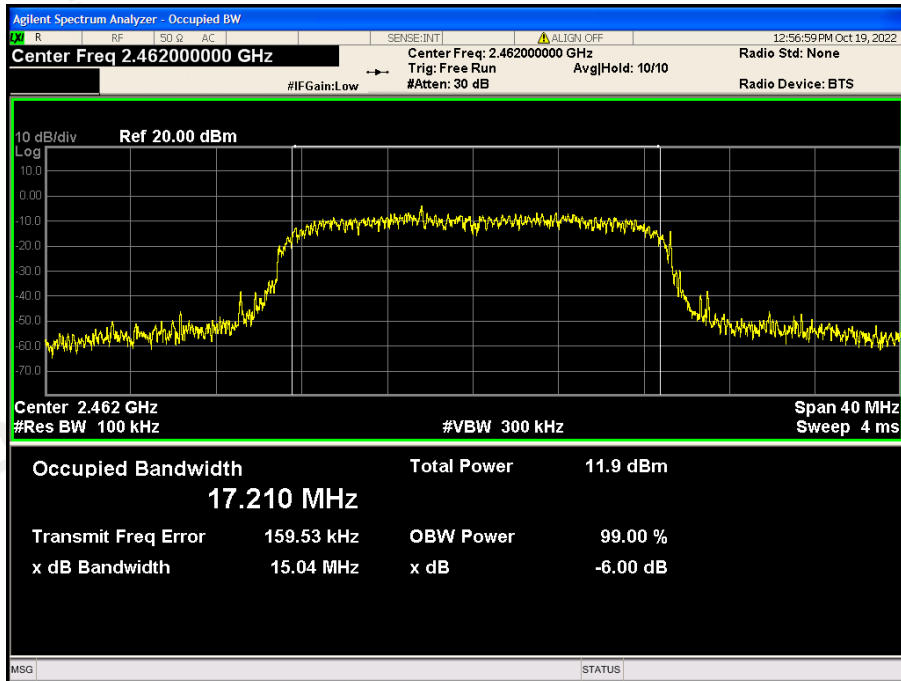

CH11: 2462MHz

TX 802.11n/HT40 Mode			
Frequency (MHz)	6dB Bandwidth (MHz)	Channel Separation (kHz)	Result
2422	26.65	>=500	PASS
2437	27.55	>=500	PASS
2452	29.22	>=500	PASS

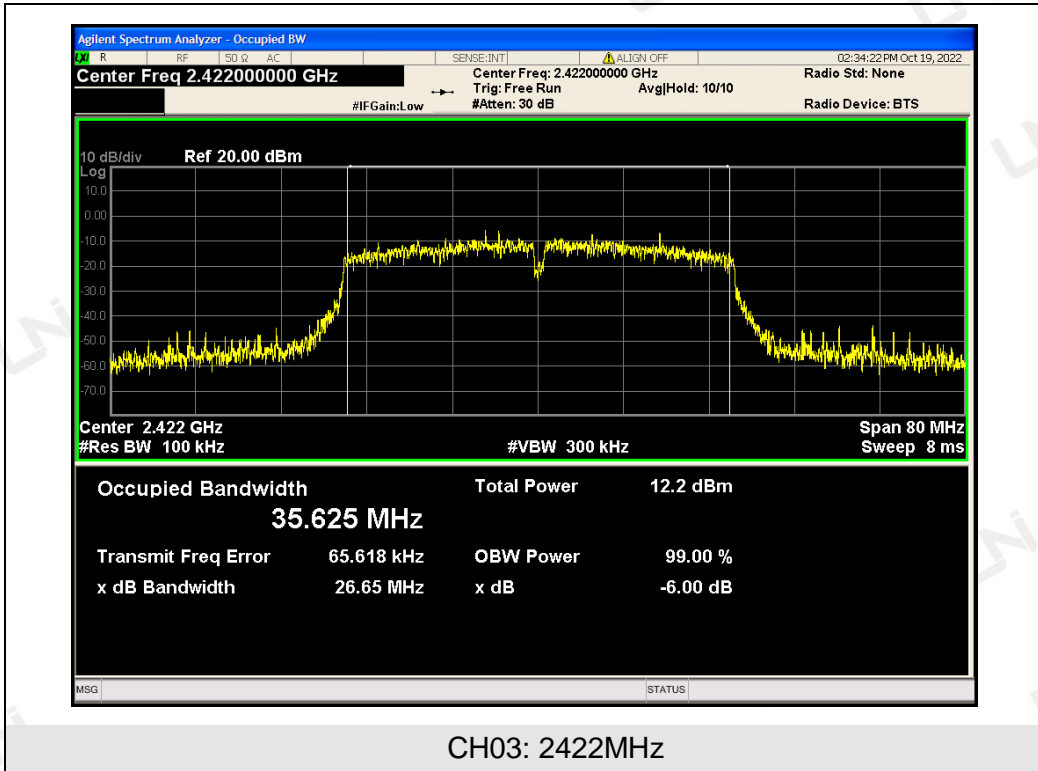

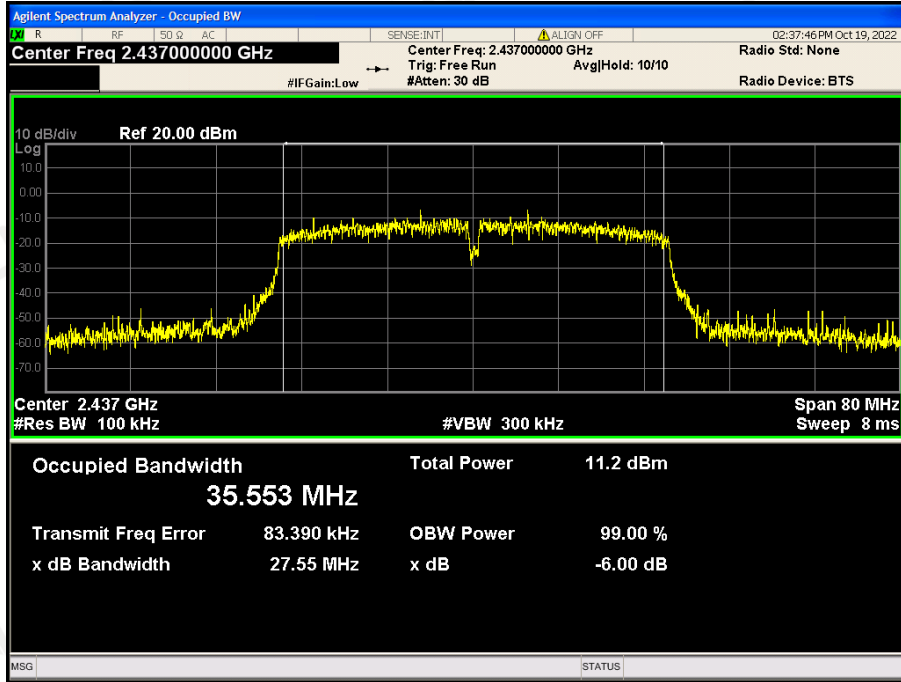

CH06: 2437MHz

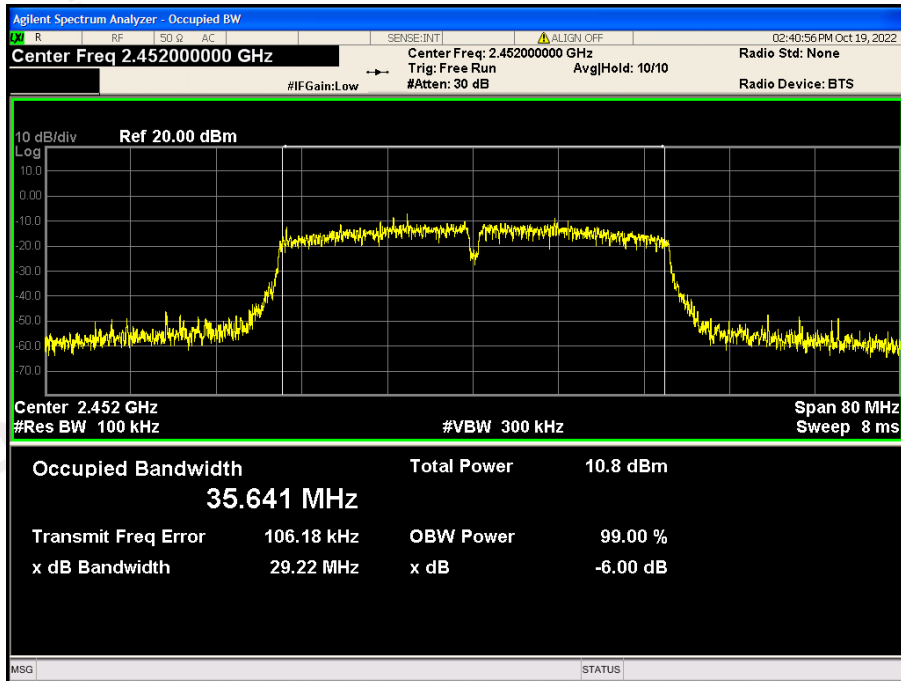

CH09: 2452MHz

6 POWER SPECTRAL DENSITY

6.1 TESTLIMIT

FCC Part15(15.247), Subpart C				
Section	Test Item	Limit	Frequency Range (MHz)	Result
15.247	Power Spectral Density	8 dBm (in any 3kHz)	2400-2483.5	PASS

6.2 TEST PROCEDURE

1. The EUT was placed on a turn table which is 0.8m above ground plane.
2. Set EUT as normal operation.
3. Based on FCC Part15 C Section 15.247: RBW=3kHz, VBW=10kHz.
4. The useful radiated emission from the EUT was detected by the spectrum analyzer with peak detector.

6.3 EQUIPMENT USED

Same as Radiated Emission Measurement.

6.4 TESTRESULT

PASS

TX 802.11b Mode			
Frequency (MHz)	Power Density (dBm/3kHz)	Limit (dBm/3kHz)	Result
2412	-12.075	8	PASS
2437	-7.748	8	PASS
2462	-7.928	8	PASS

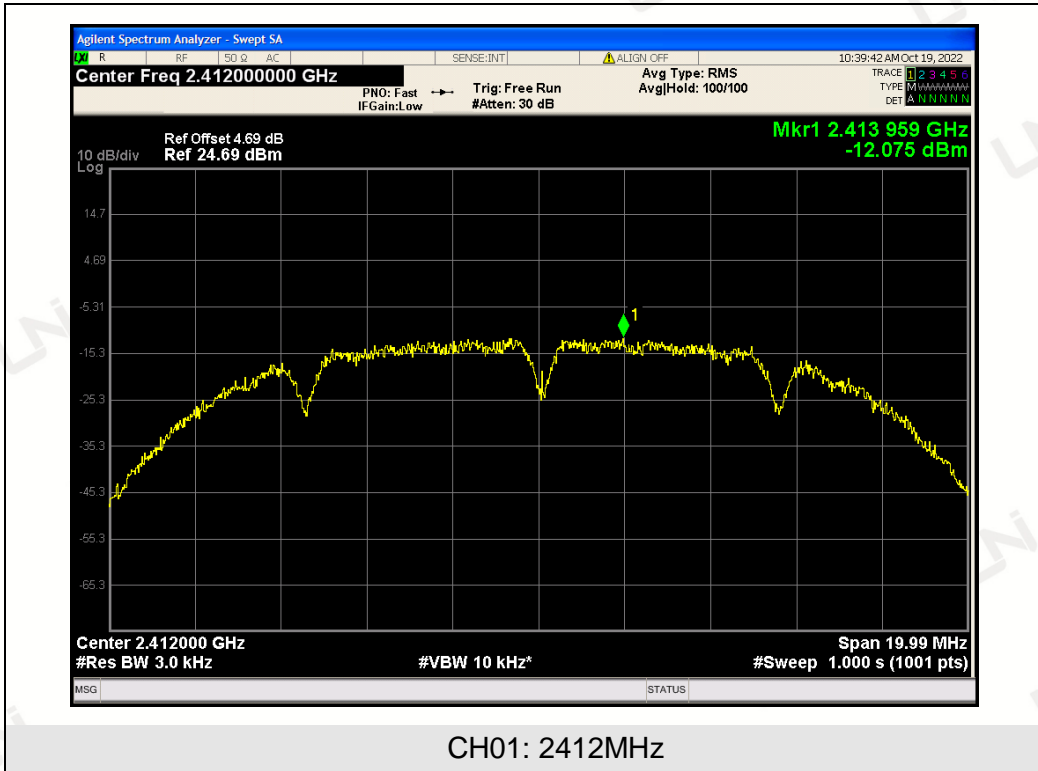

CH01: 2412MHz

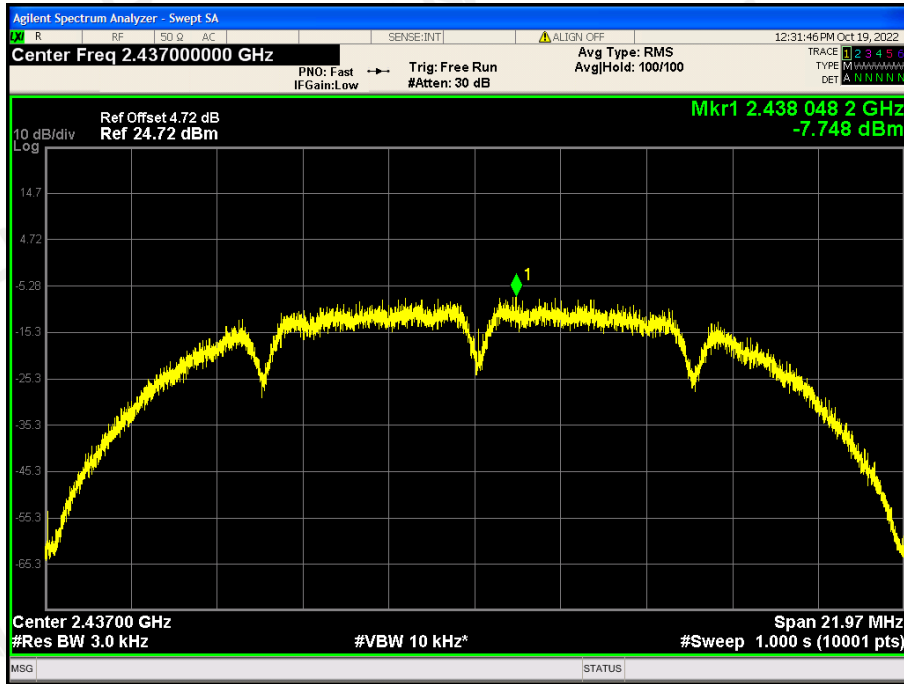

CH06: 2437MHz

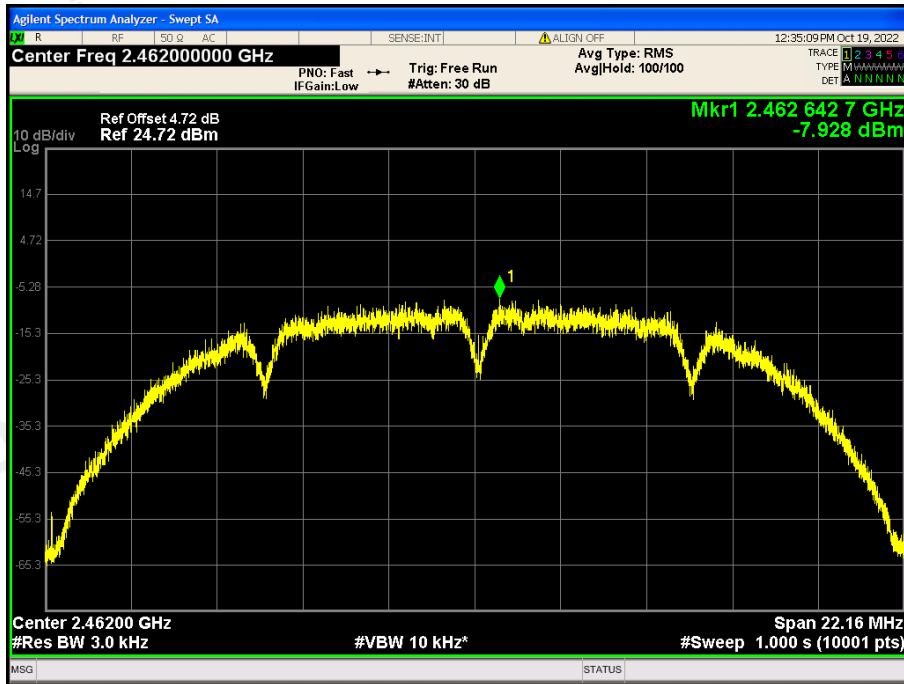

CH11: 2462MHz

TX 802.11g Mode			
Frequency (MHz)	Power Density (dBm/3kHz)	Limit (dBm/3kHz)	Result
2412	-11.174	8	PASS
2437	-11.448	8	PASS
2462	-12.121	8	PASS

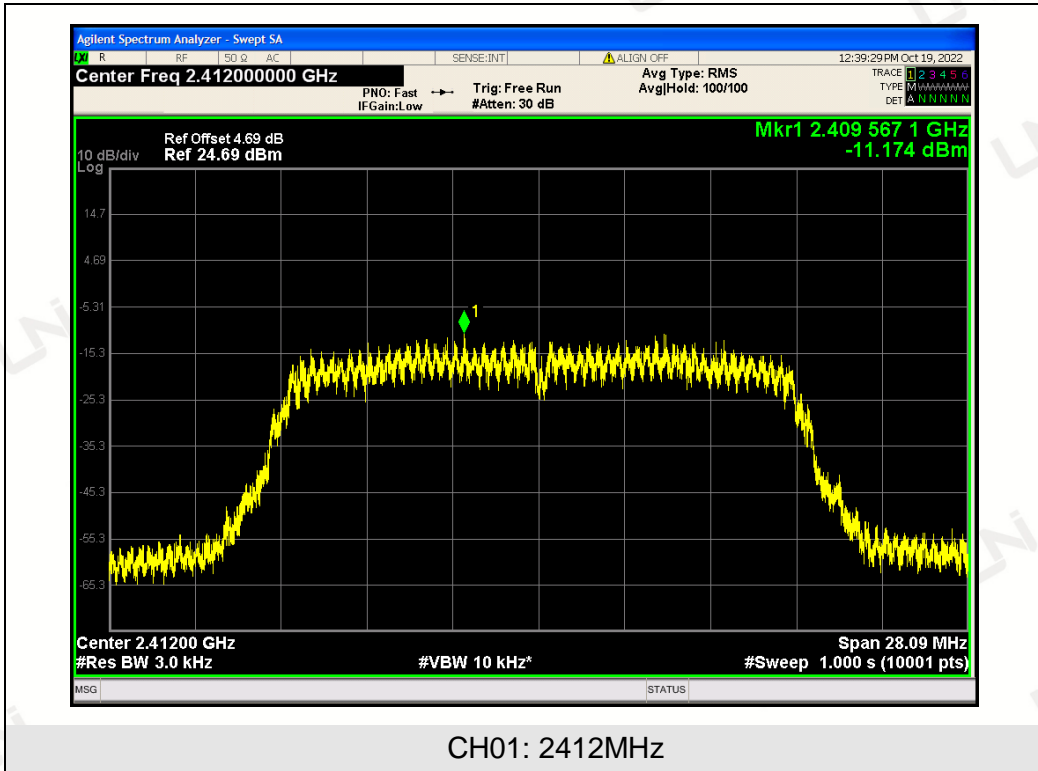

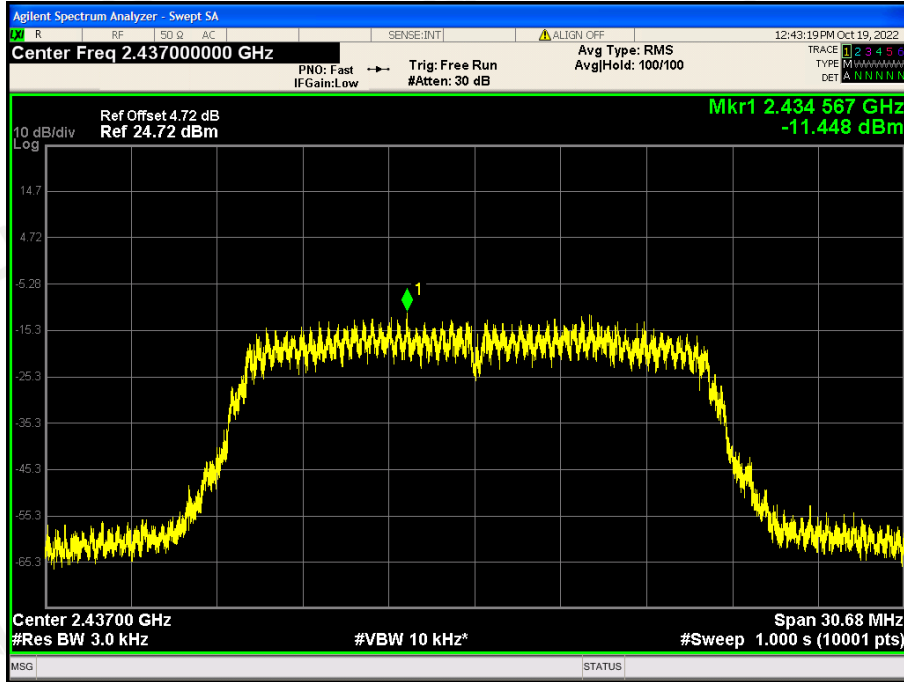

CH06: 2437MHz

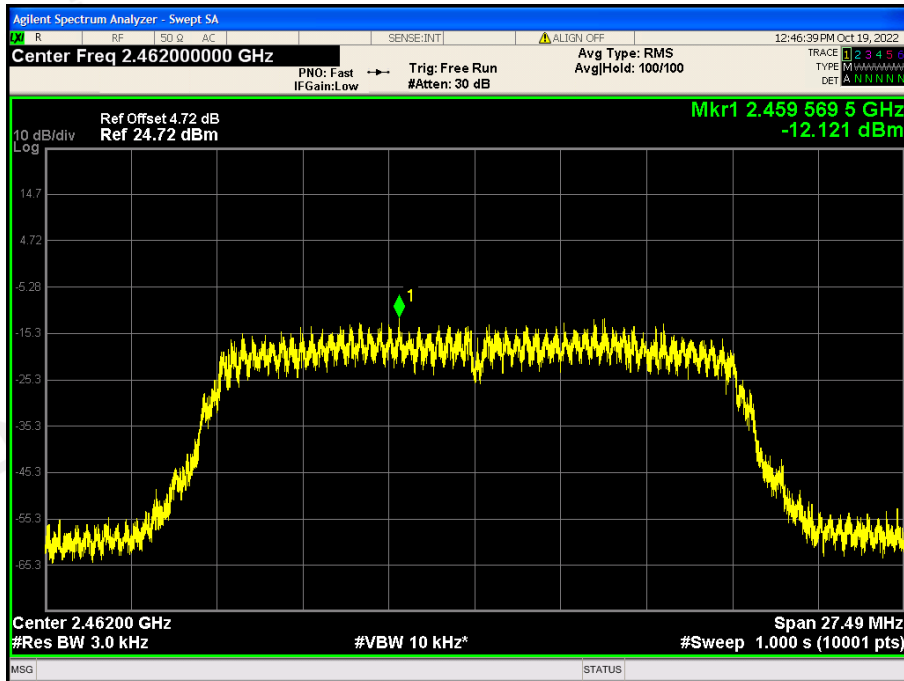

CH11: 2462MHz

TX 802.11n/HT20 Mode			
Frequency (MHz)	Power Density (dBm/3kHz)	Limit (dBm/3kHz)	Result
2412	-12.408	8	PASS
2437	-12.990	8	PASS
2462	-13.335	8	PASS

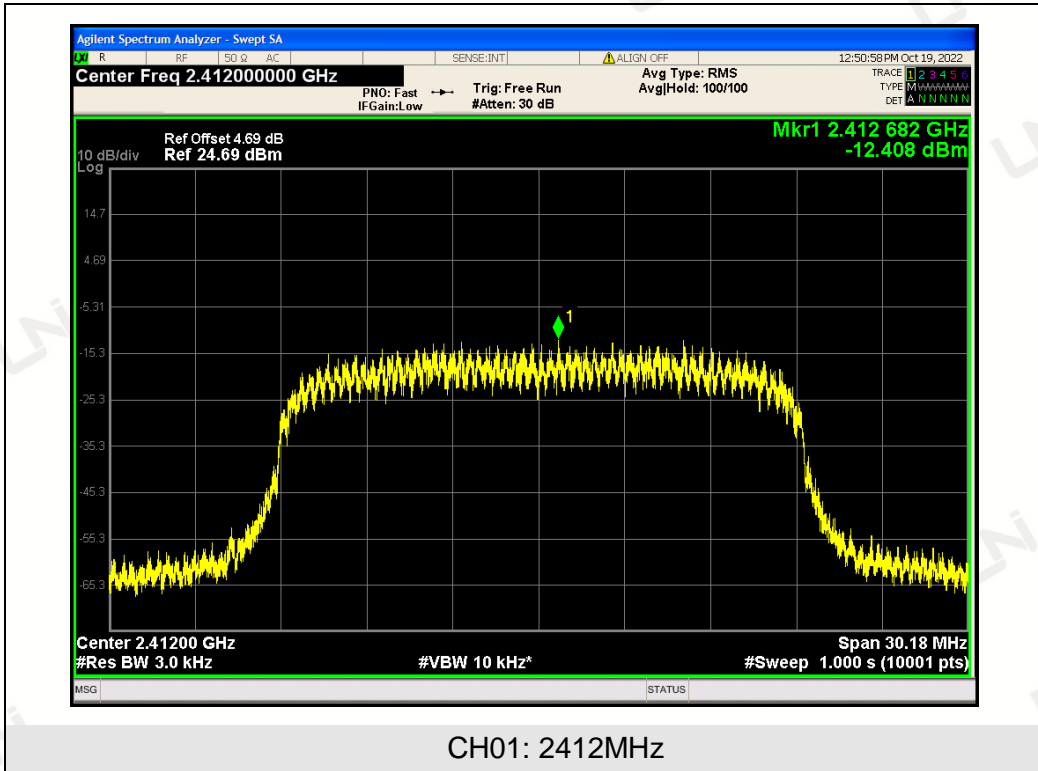

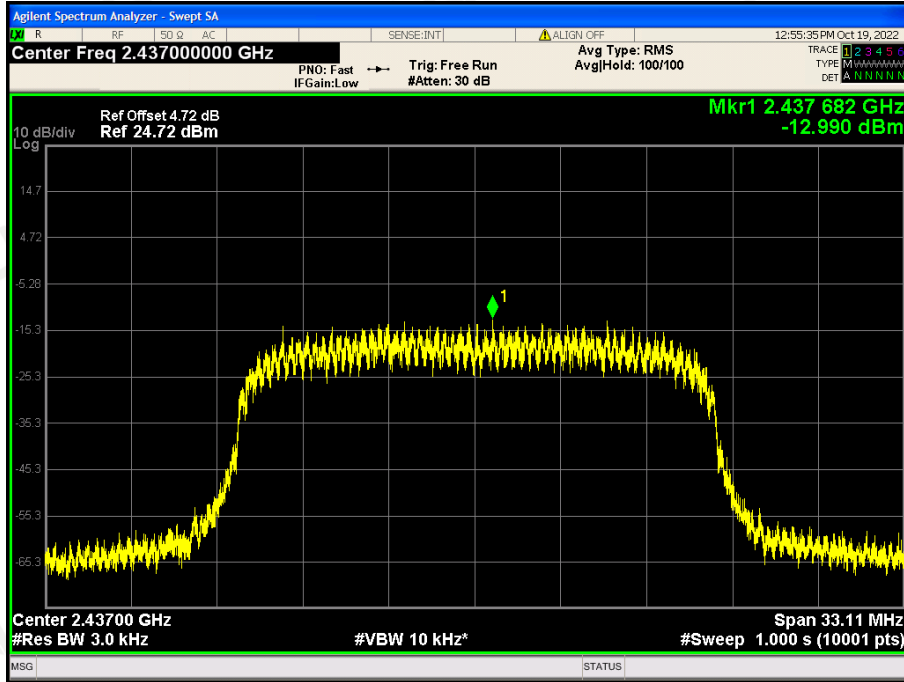

CH06: 2437MHz

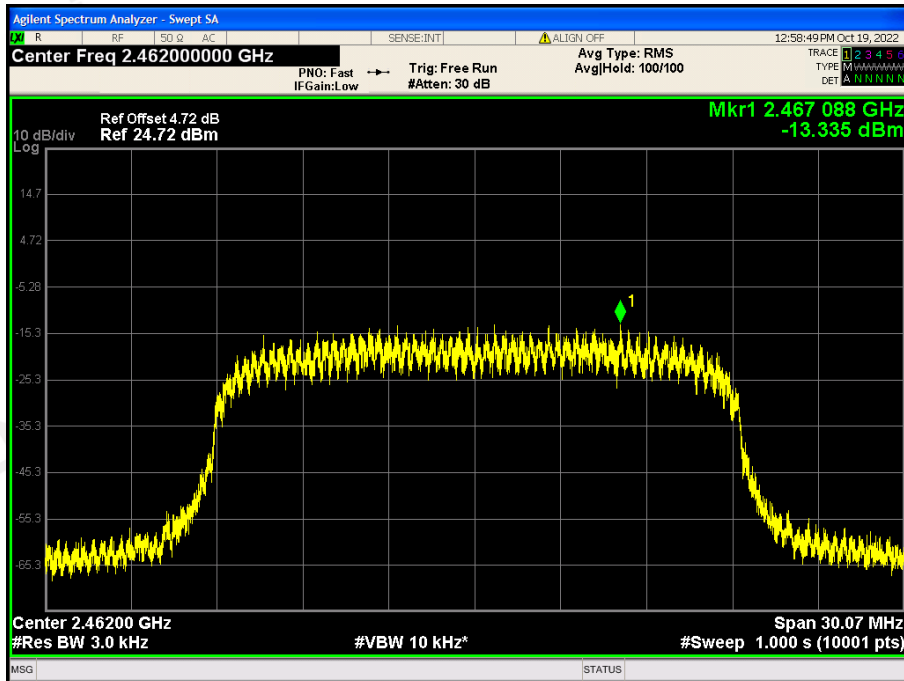

CH11: 2462MHz

TX 802.11n/HT40 Mode			
Frequency (MHz)	Power Density (dBm/3kHz)	Limit (dBm/3kHz)	Result
2422	-16.383	8	PASS
2437	-17.500	8	PASS
2452	-17.779	8	PASS

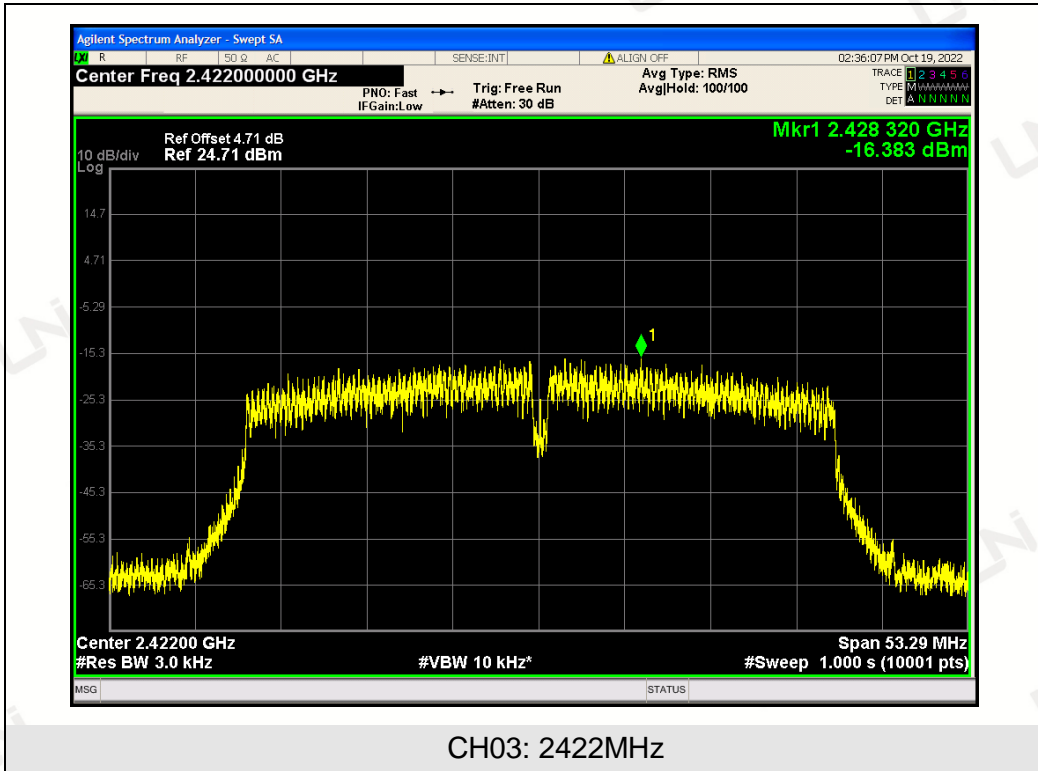

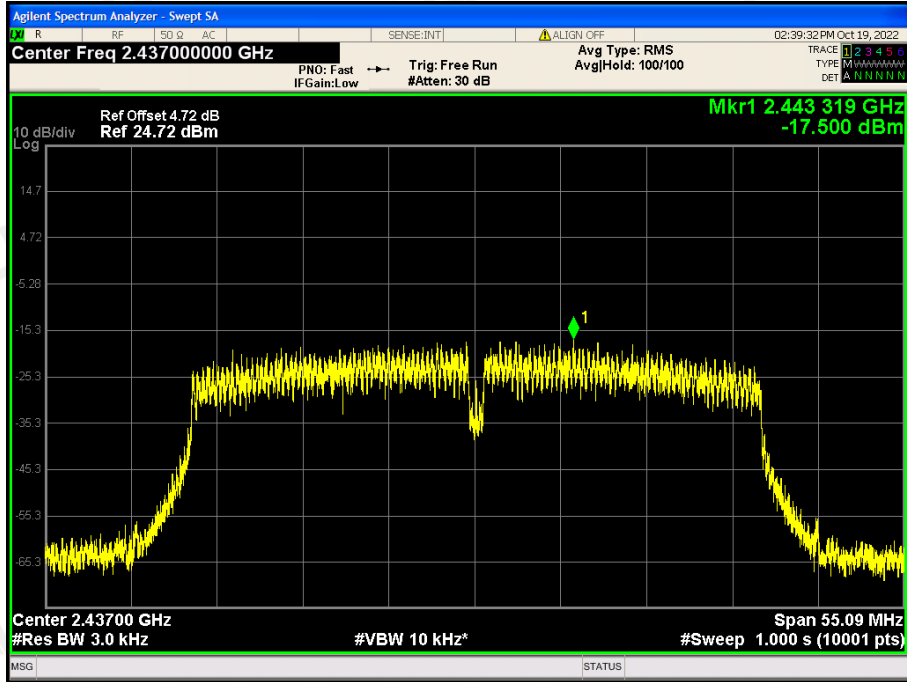

CH06: 2437MHz

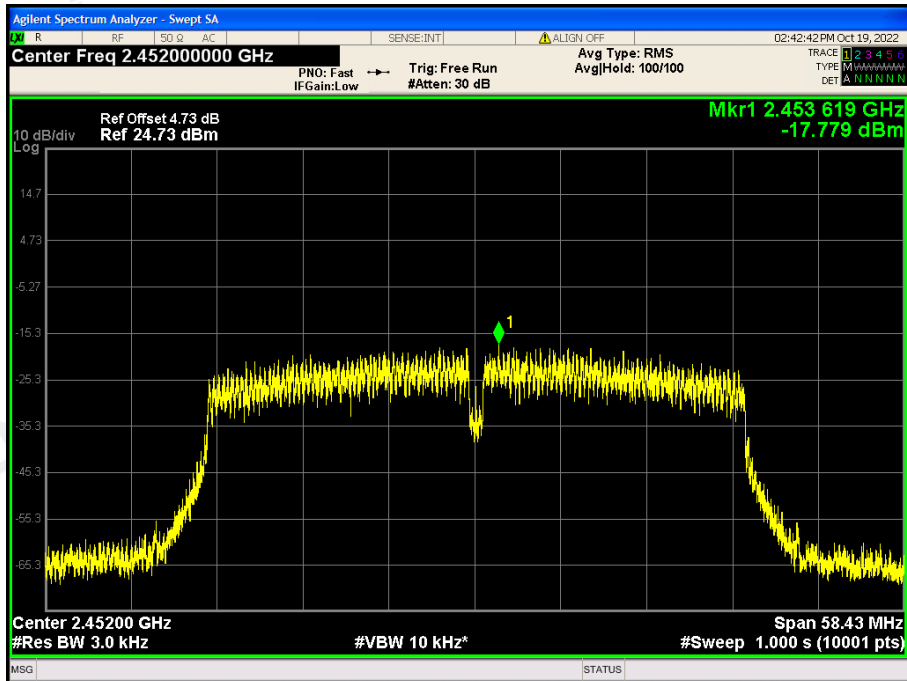

CH09: 2452MHz

7 PEAK OUTPUT POWER

7.1 TESTLIMIT

FCC Part15(15.247), Subpart C				
Section	Test Item	Limit	Frequency Range (MHz)	Result
15.247(b)(3)	Peak Output Power	1 watt or 30dBm	2400-2483.5	PASS

7.2 TEST PROCEDURE

1. The EUT was placed on a turn table which is 0.8m above ground plane.
2. The EUT was directly connected to the Power meter.

7.3 EQUIPMENT USED

Same as Radiated Emission Measurement.

7.4 TEST RESULT

PASS

Test Mode	Frequency (MHz)	Maximum Peak Conducted Output Power(dBm)	Limit (dBm)
802.11b	2412	18.81	30
	2437	18.45	30
	2462	18.12	30
802.11g	2412	19.25	30
	2437	18.68	30
	2462	18.22	30
802.11n/HT20	2412	18.11	30
	2437	17.62	30
	2462	17.27	30
802.11n/HT40	2422	17.14	30
	2437	16.12	30
	2452	15.58	30

8 OUT OF BAND EMISSIONS

8.1 TEST LIMIT

In any 100 kHz bandwidth outside the frequency band in which the spread spectrum or digitally modulated intentional radiator is operating, the radio frequency power that is produced by the intentional radiator shall be at least 20 dB below that in the 100 kHz bandwidth within the band that contains the highest level of the desired power, based on either an RF conducted or a radiated measurement, provided the transmitter demonstrates compliance with the peak conducted power limits. If the transmitter complies with the conducted power limits based on the use of RMS averaging over a time interval, as permitted under paragraph (b)(3) of this section, the attenuation required under this paragraph shall be 30 dB instead of 20 dB.

8.2 TEST SETUP

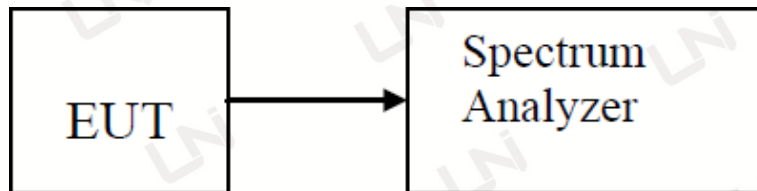

8.3 TEST PROCEDURE

1. The EUT was placed on a turn table which is 0.8m above ground plane.
2. Set EUT as TX operation and connect directly to the spectrum analyzer.
3. Based on FCC Part15 C Section 15.247: RBW=100kHz, VBW=300kHz.
4. Set detected by the spectrum analyzer with peak detector.

8.4 TEST RESULT

PASS

TX 802.11b Mode: CH01: 2412MHz

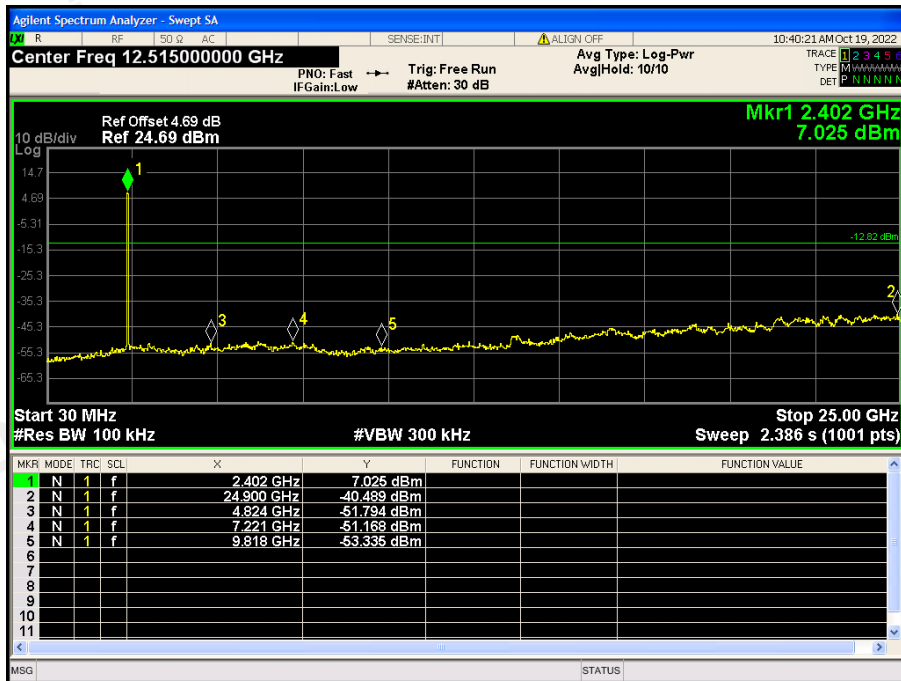
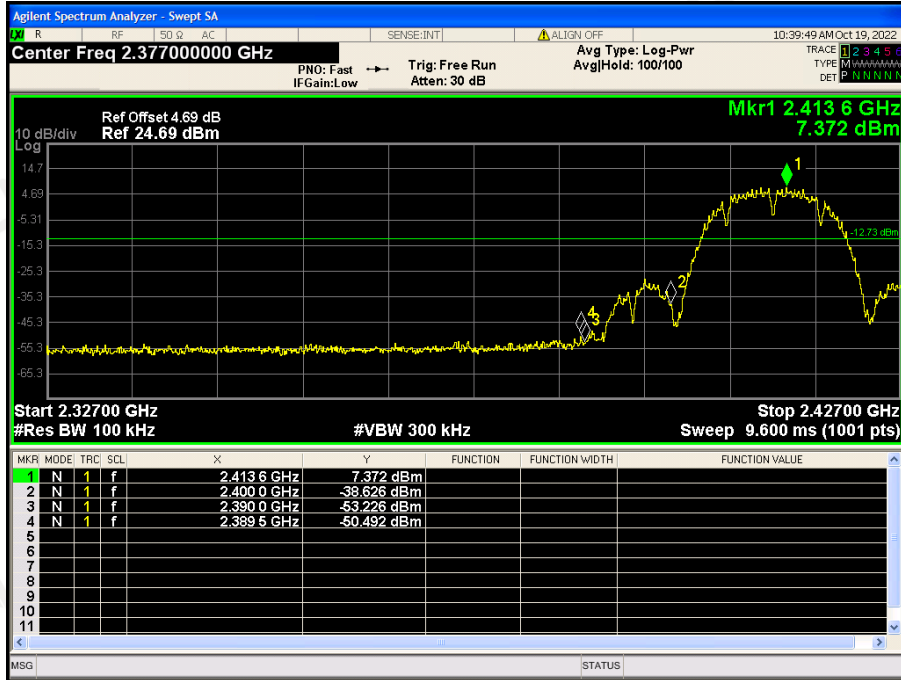

TX 802.11b Mode: CH06: 2437MHz

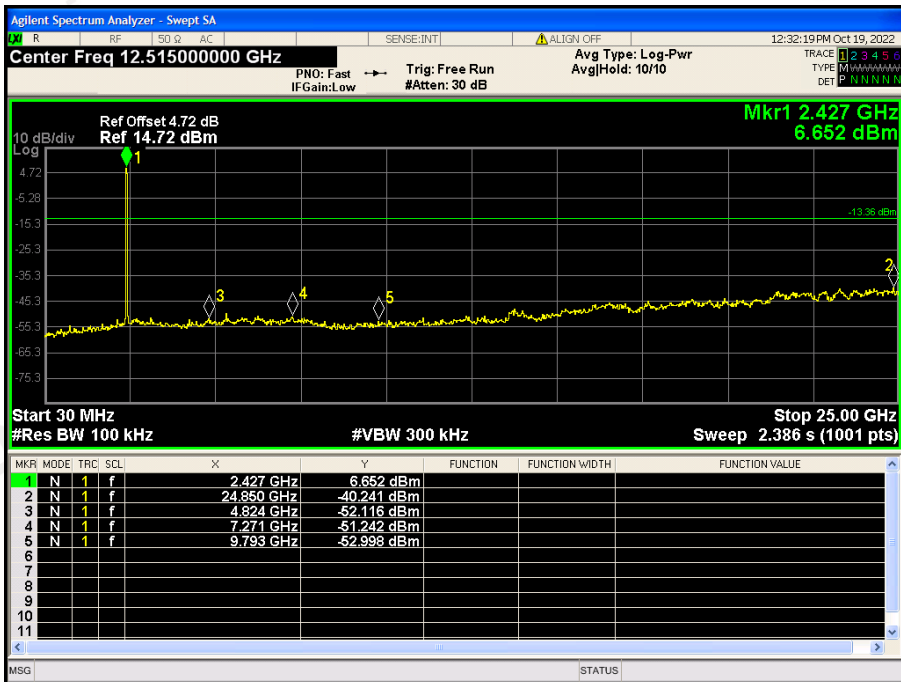
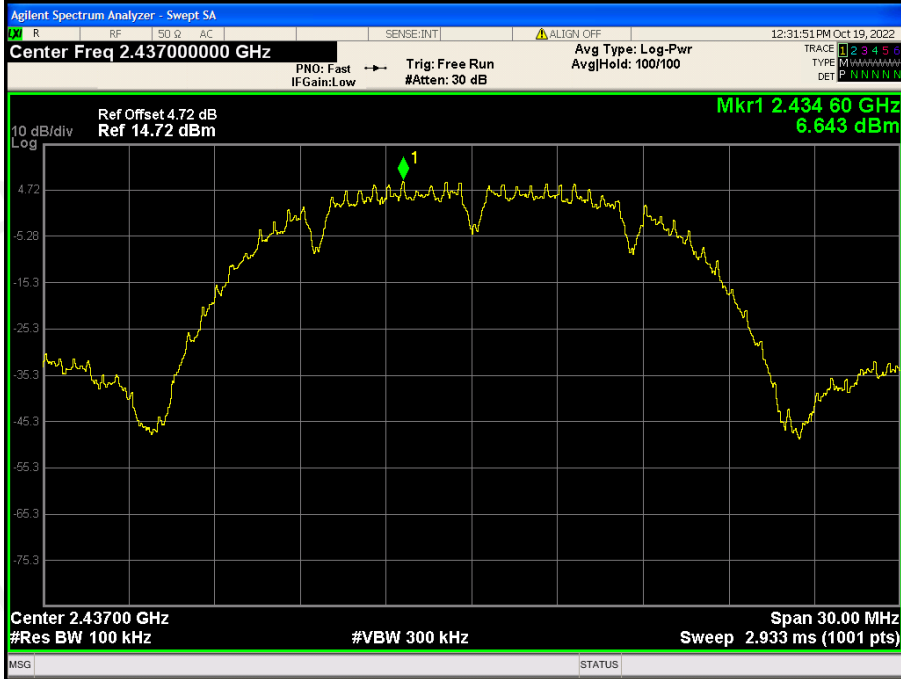

TX 802.11b Mode: CH11: 2462MHz

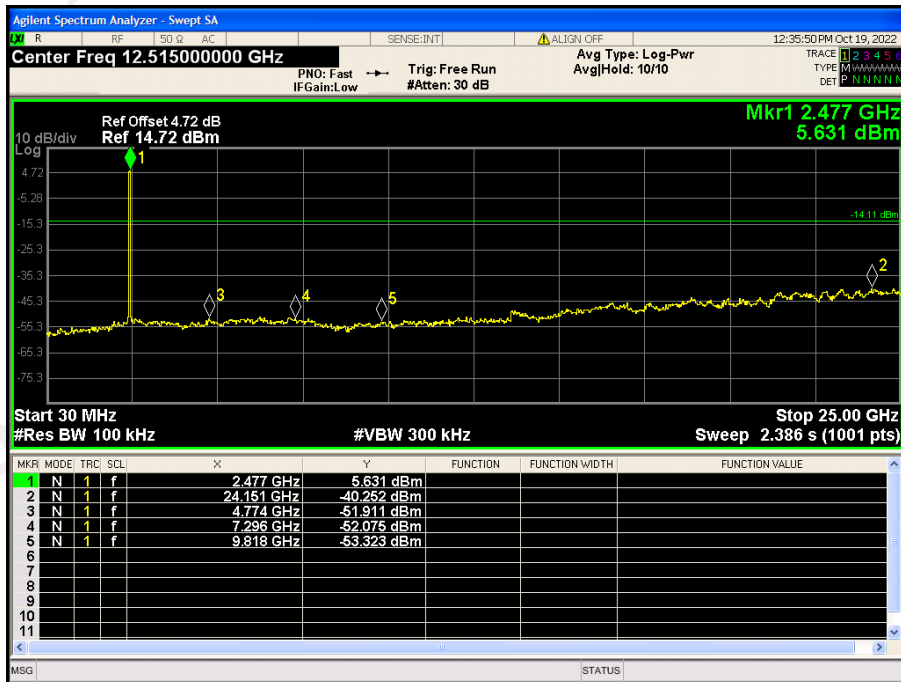
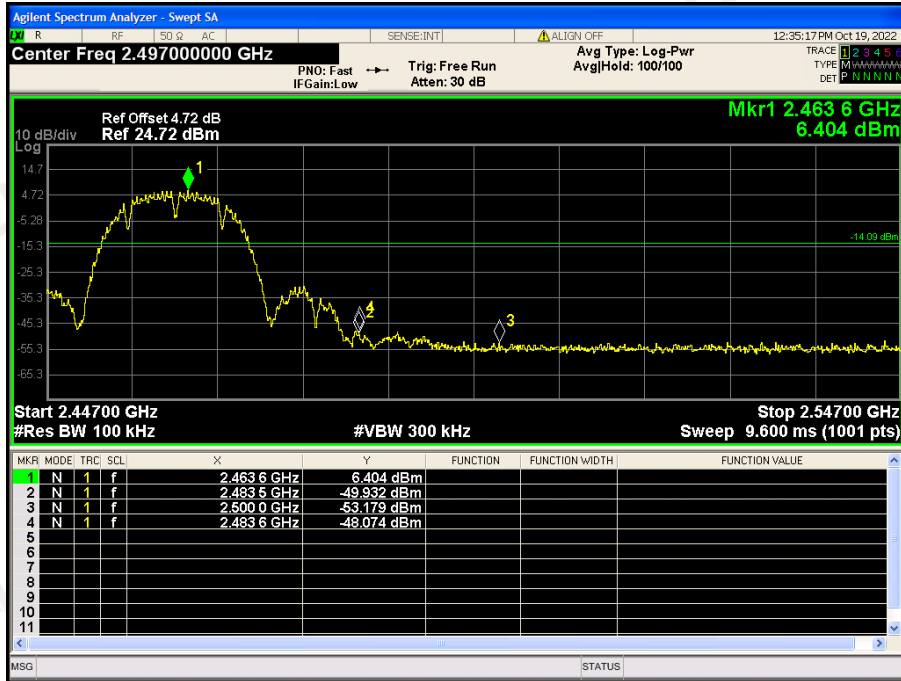

TX 802.11g Mode: CH01: 2412MHz

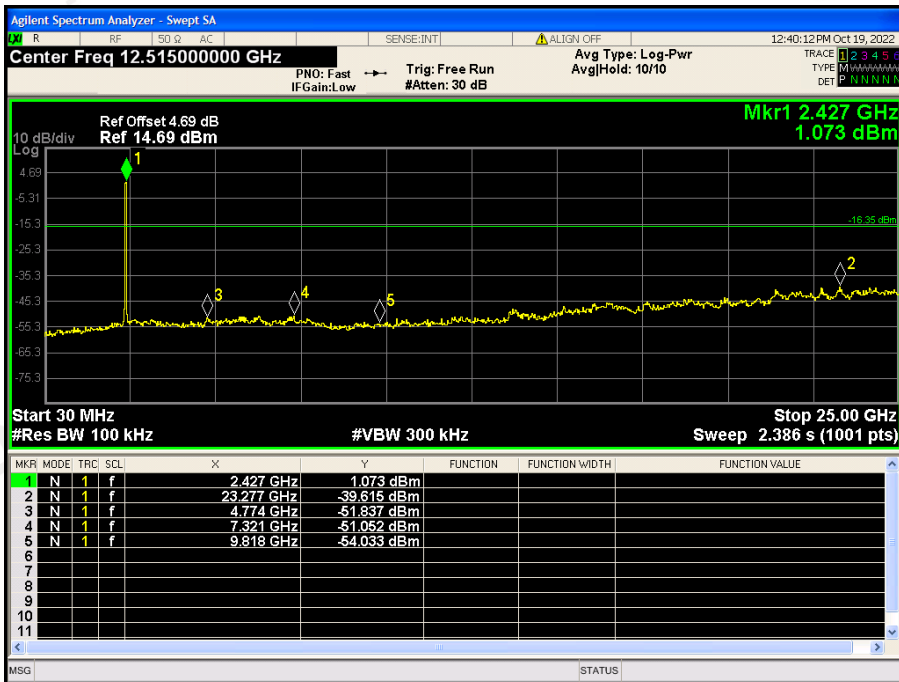
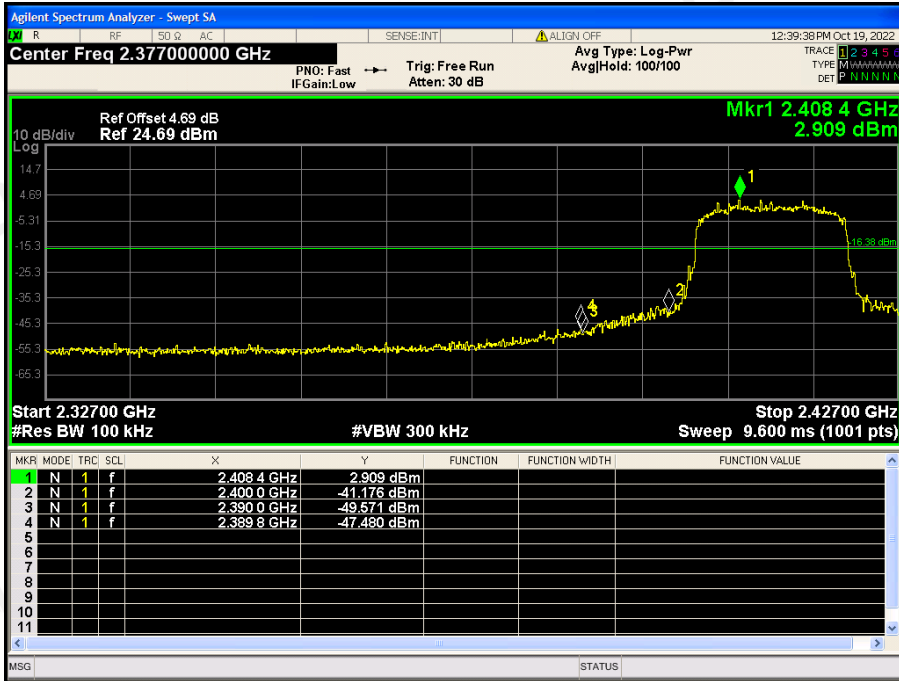



TX 802.11g Mode: CH11: 2462MHz

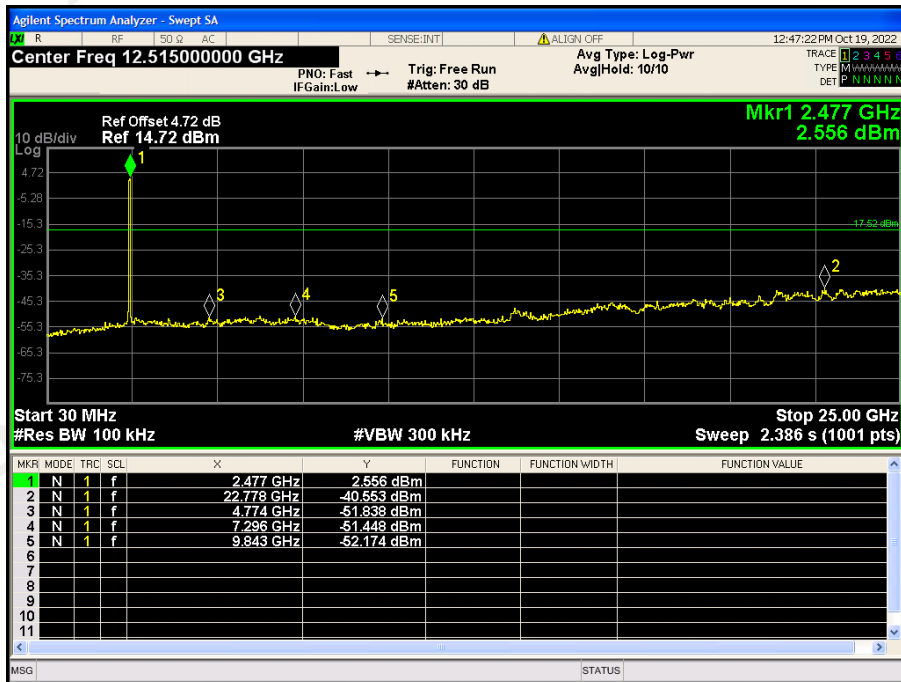
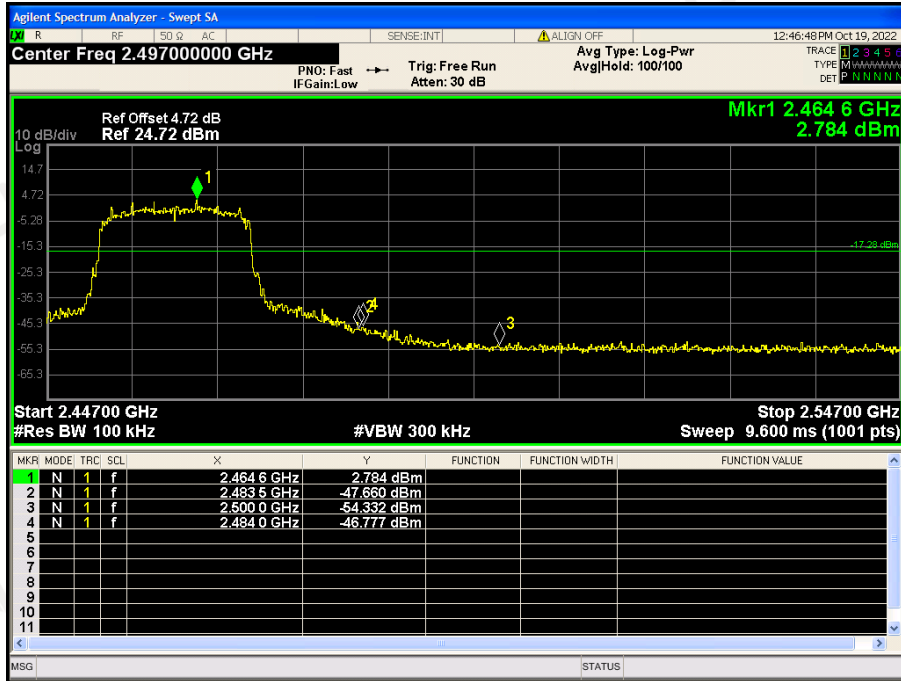

TX 802.11n/HT20 Mode: CH01: 2412MHz

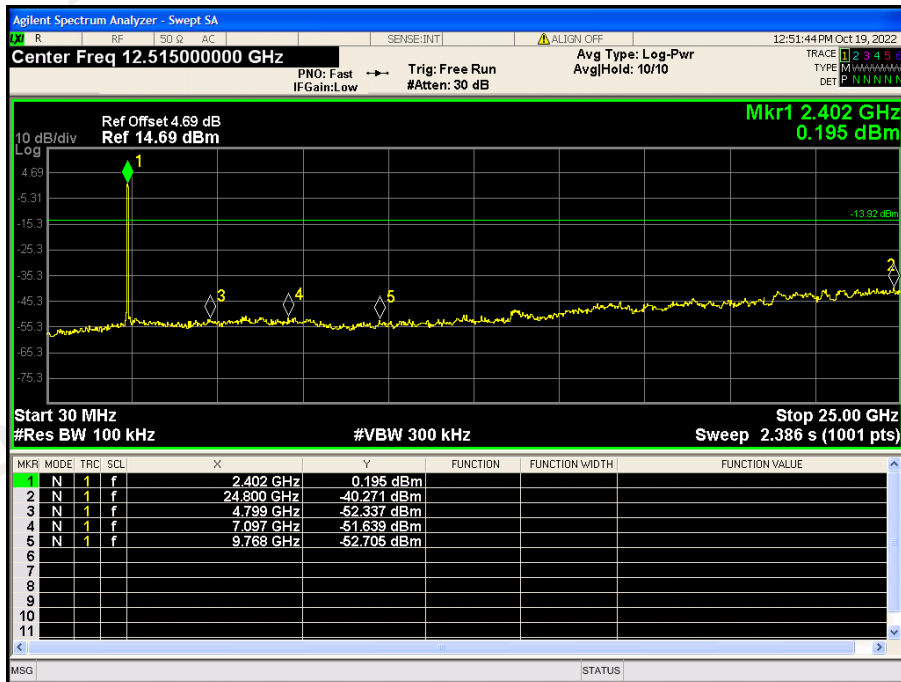
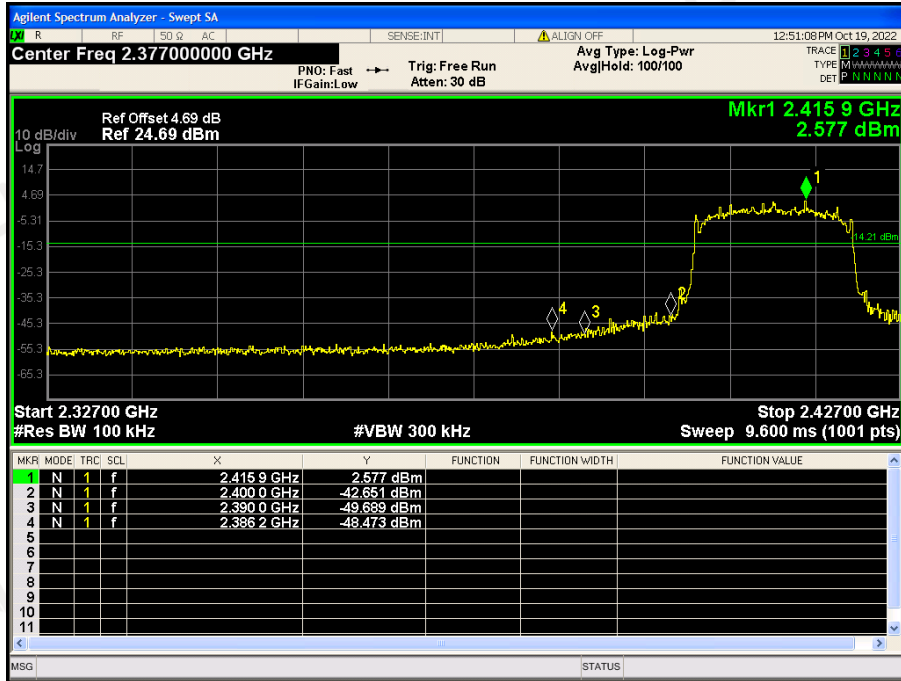

TX 802.11n/HT20 Mode: CH06: 2437MHz

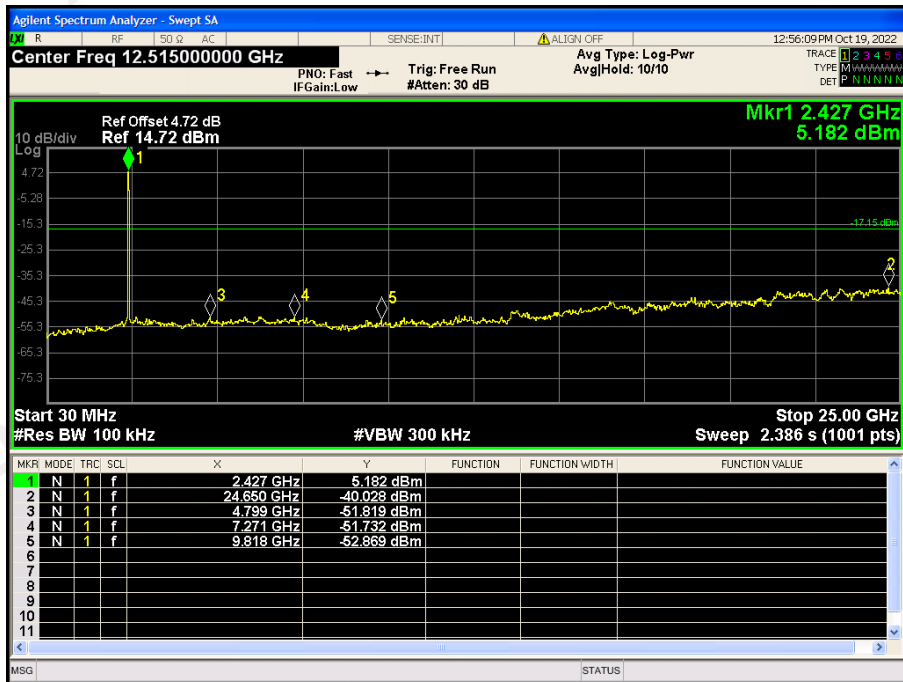
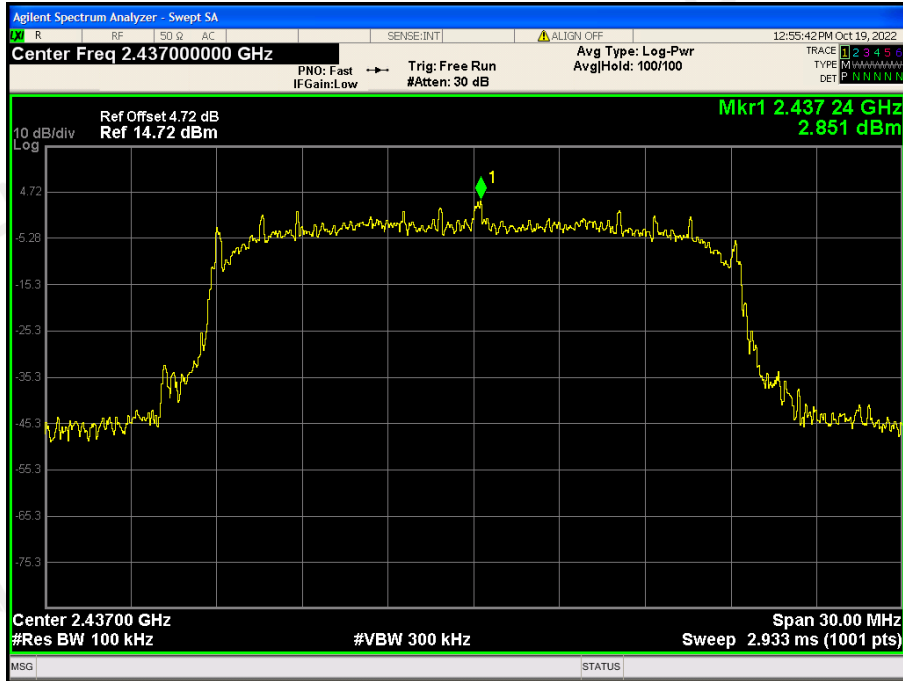

TX 802.11n/HT20 Mode: CH11: 2462MHz

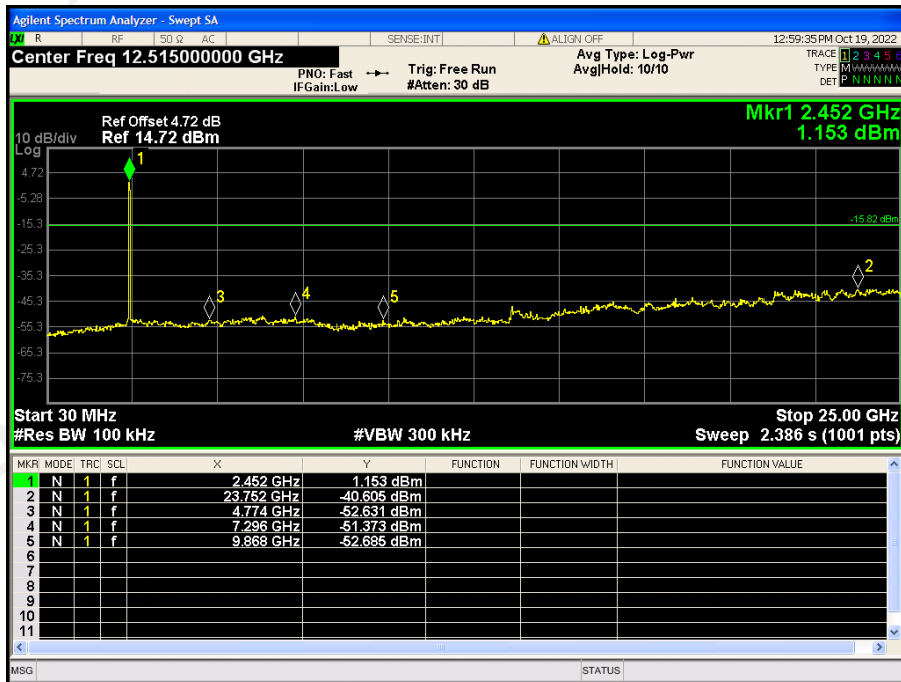
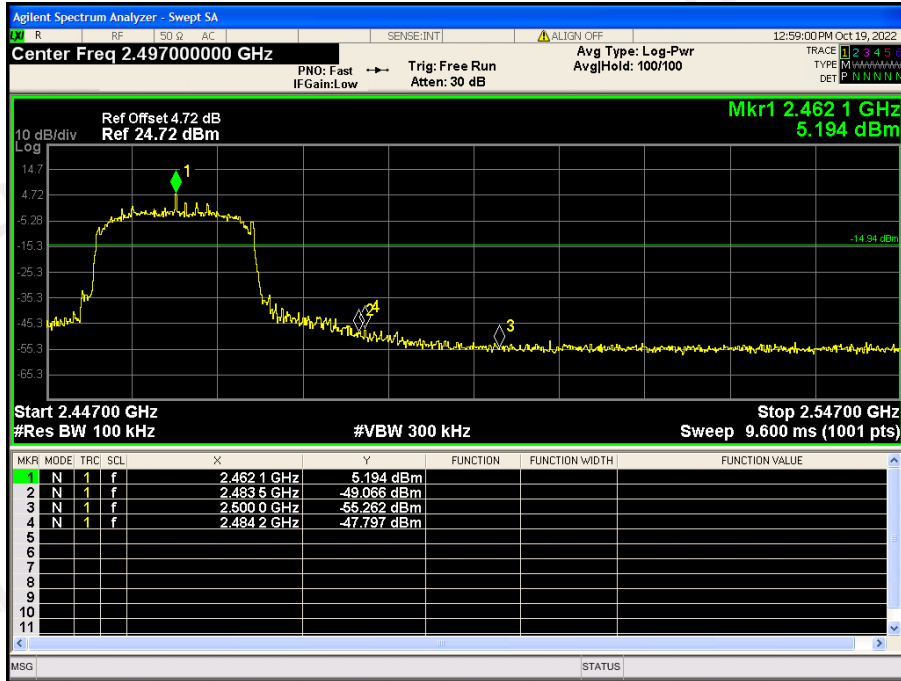

TX 802.11n/HT40 Mode: CH03: 2422MHz

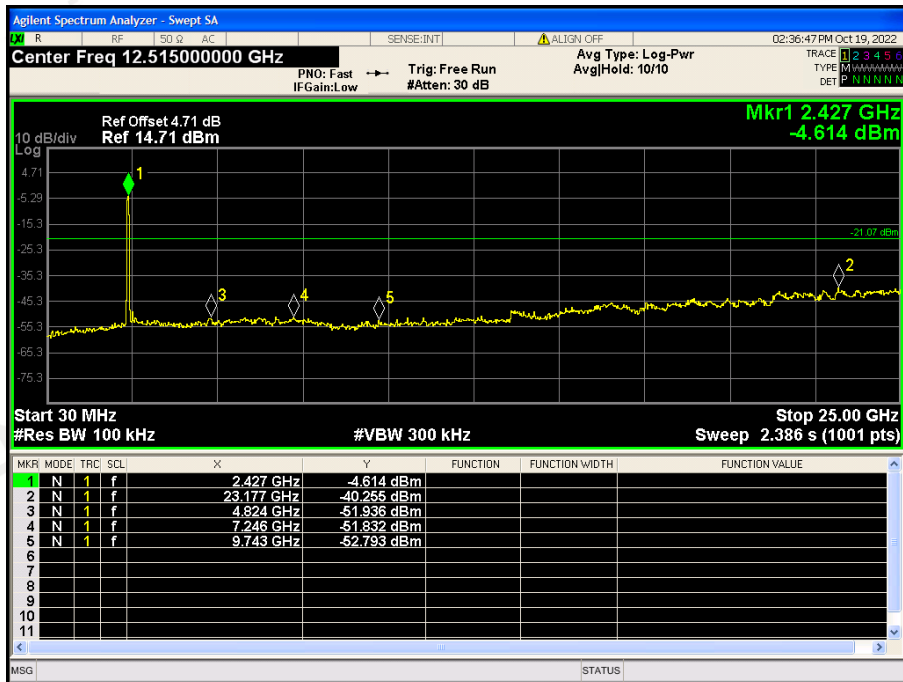
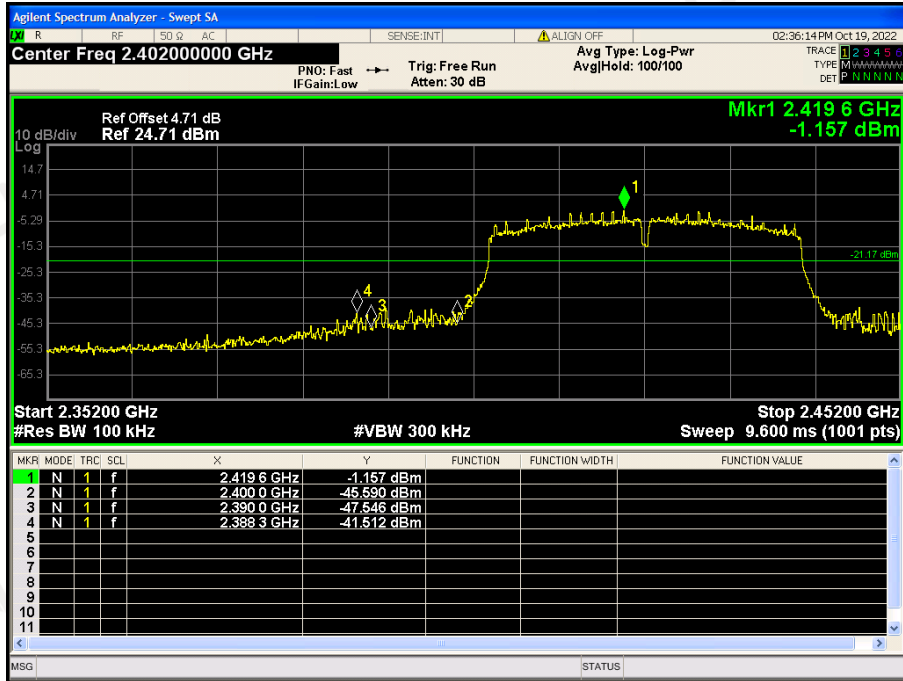

TX 802.11n/HT40 Mode: CH06: 2437MHz

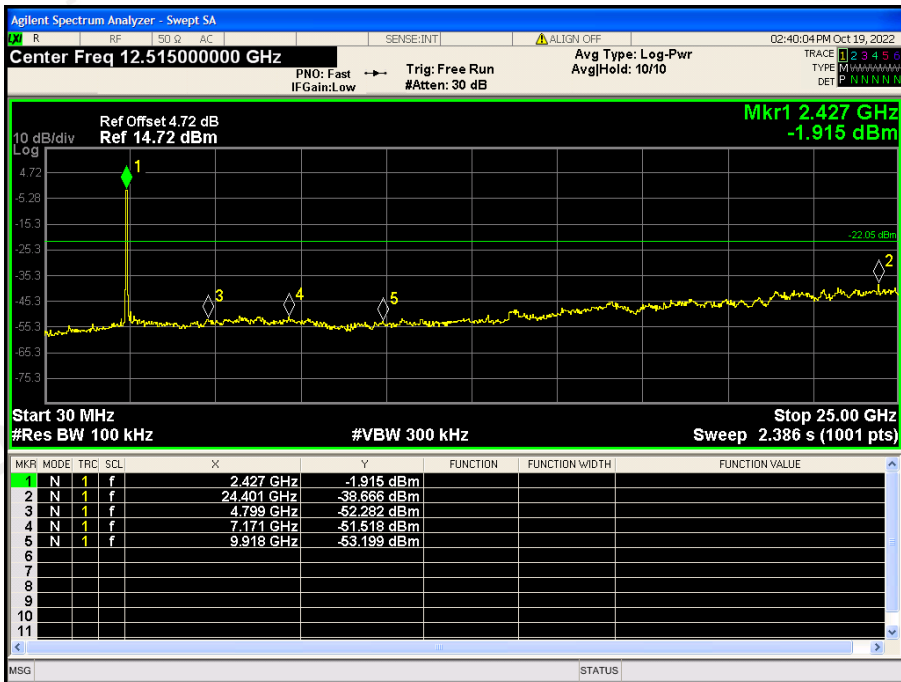
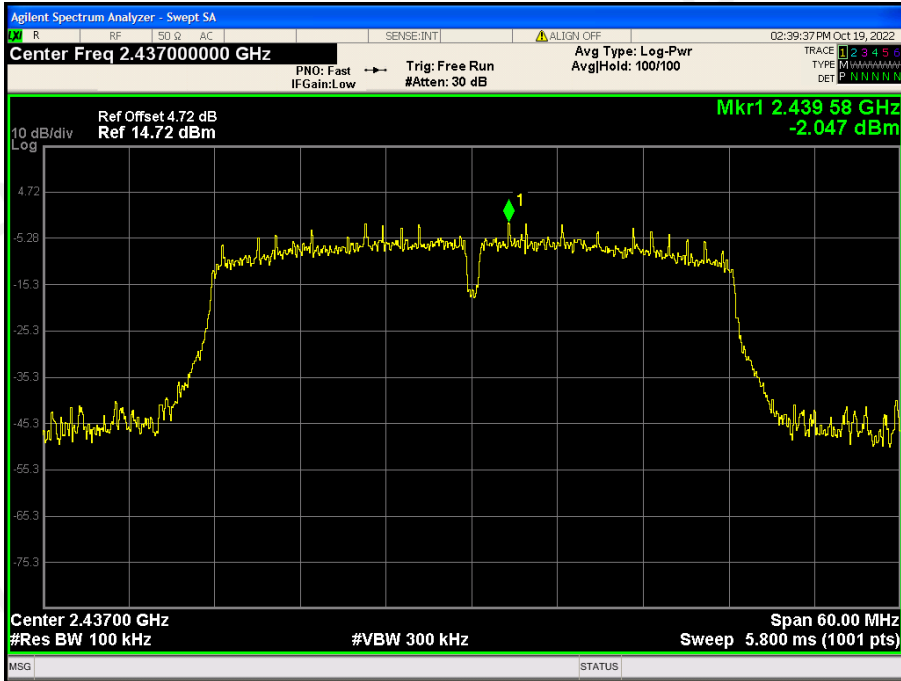

TX 802.11n/HT40 Mode: CH09: 2452MHz

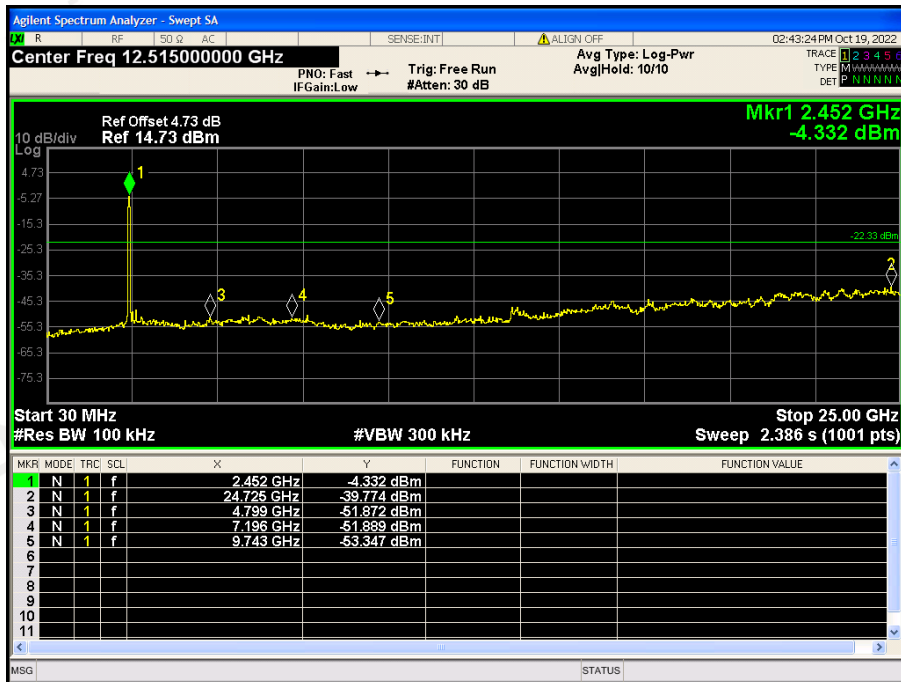
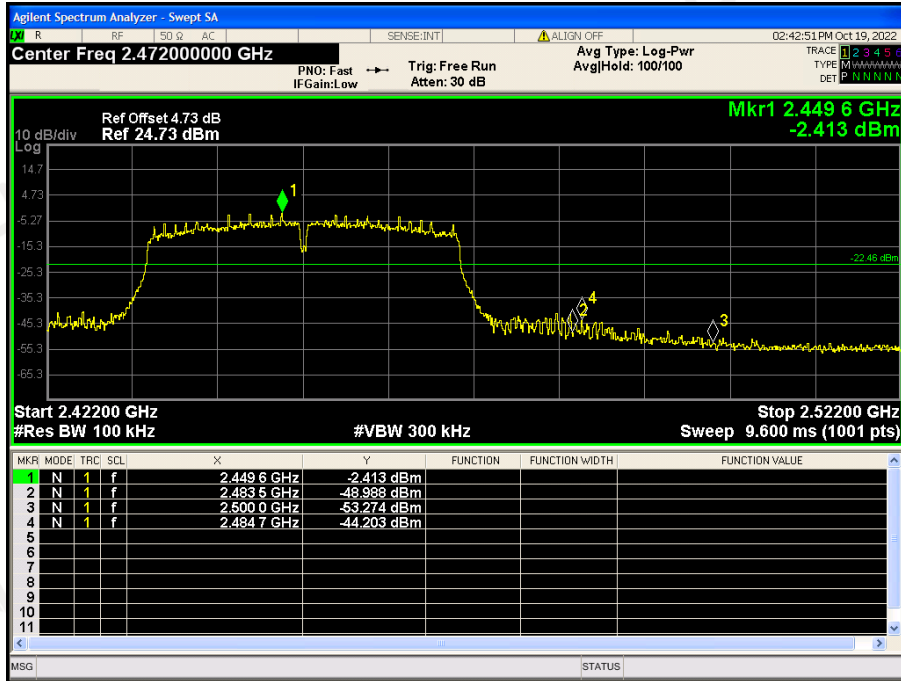

9 ANTENNA REQUIREMENT

Standard Applicable:

For intentional device, according to FCC 47 CFR Section 15.203, an intentional radiator shall be designed to ensure that no antenna other than that furnished by the responsible party shall be used with the device.

Antenna Connected Construction

The antenna used in this product is a PCB Antenna, The directional gains of antenna used for transmitting is 2.21dBi.

ANTENNA:

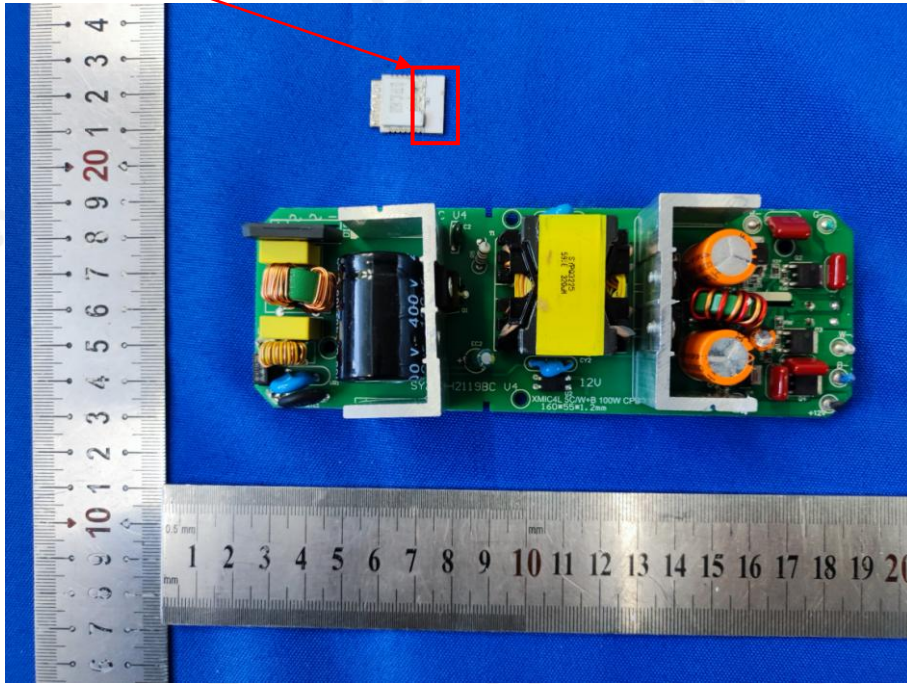

10 PHOTO OF TEST

10.1 RADIATED EMISSION



10.2 CONDUCTED EMISSION



End of Report