

**CFR 47 FCC PART 15 SUBPART E  
ISED RSS-247 ISSUE 3 (U-NII)**

**TEST REPORT**

*For*

**Indoor Access Point**

**MODEL NUMBER: AP-N515**

**REPORT NUMBER: E04A23010057F02003**

**ISSUE DATE: February 20, 2024**

**FCC ID: 2A2PW162394**

**IC: 29598-162394**

**Brand:  FS**

*Prepared for*

**FS.COM Inc.**

**380 Centerpoint Blvd, New Castle, DE 19720, United States**

*Prepared by*

**Guangdong Global Testing Technology Co., Ltd.**

**Room 101-105, 203-210, Building 1, No.2, Keji 8 Road, Songshan Lake Park,  
Dongguan city, Guangdong, People's Republic of China, 523808**

**This report is based on a single evaluation of the submitted sample(s) of the above mentioned  
Product, it does not imply an assessment of the production of the products.**

**This report shall not be reproduced, except in full, without the written approval of Guangdong  
Global Testing Technology Co., Ltd.**

Revision History

<u>Rev.</u>	<u>Issue Date</u>	<u>Revisions</u>	<u>Revised By</u>
<u>V0</u>	<u>February 20, 2024</u>	<u>Initial Issue</u>	<u>Jok Yang</u>

### Summary of Test Results

Test Item	Clause	Limit/Requirement	Result
ON TIME AND DUTY CYCLE	ANSI C63.10-2013, Clause 12.2	None; for reporting purposes only.	Pass
6dB AND 26dB EMISSION BANDWIDTH AND 99% OCCUPIED BANDWIDTH	KDB 789033 D02 v02r01 Section C.1	FCC Part 15.407 (a)(2)(5), RSS-247 ISSUE 3, Clause 6.2.1.2 ,RSS-Gen Clause 6.6	Pass
CONDUCTED OUTPUT POWER	KDB 789033 D02 v02r01 Section E.3.a (Method PM)	FCC 15.407 (a) ,RSS-247 Clause 6.2	Pass
POWER SPECTRAL DENSITY	KDB 789033 D02 v02r01 Section F	FCC 15.407 (a), RSS-247 Clause 6.2	Pass
AC Power Line Conducted Emission	ANSI C63.10-2013, Clause 6.2.	FCC 15.207, RSS-GEN Clause 8.8	Pass
Radiated Emissions and Band Edge Measurement	KDB 789033 D02 v02r01 Section G.3, G.4, G.5, and G.6	FCC 15.407 (b) FCC 15.209 FCC 15.205, RSS-247 Clause 6.2 RSS-GEN Clause 8.9	Pass
FREQUENCY STABILITY	N/A	FCC 15.407 (g),RSS-247 ISSUE 3 Clause6	Pass
Dynamic Frequency Selection (Master)	KDB 905462 D02 UNII DFS Compliance Procedures New Rules v02	FCC Part 15.407 (h), RSS-247 ISSUE 3 Clause6.3	Pass
Antenna Requirement	N/A	FCC 47 CFR Part 15.203/ 15.407(a)(1) (2), RSS-Gen Issue 5, Clause 6.8	Pass

\*This test report is only published to and used by the applicant, and it is not for evidence purpose in China.

\*The measurement result for the sample received is <Pass> according to <CFR 47 FCC PART 15 SUBPART E, ISED RSS-247 ISSUE 3 (U-NII)> when <Accuracy Method> decision rule is applied.

## CONTENTS

<b>1.</b>	<b>ATTESTATION OF TEST RESULTS</b> .....	<b>5</b>
<b>2.</b>	<b>TEST METHODOLOGY</b> .....	<b>6</b>
<b>3.</b>	<b>FACILITIES AND ACCREDITATION</b> .....	<b>6</b>
<b>4.</b>	<b>CALIBRATION AND UNCERTAINTY</b> .....	<b>7</b>
4.1.	<i>MEASURING INSTRUMENT CALIBRATION</i> .....	7
4.2.	<i>MEASUREMENT UNCERTAINTY</i> .....	7
<b>5.</b>	<b>EQUIPMENT UNDER TEST</b> .....	<b>8</b>
5.1.	<i>DESCRIPTION OF EUT</i> .....	8
5.2.	<i>CHANNEL LIST</i> .....	10
5.3.	<i>MAXIMUM AVERAGE EIRP</i> .....	10
5.4.	<i>THE WORSE CASE POWER SETTING PARAMETER</i> .....	11
5.5.	<i>DESCRIPTION OF AVAILABLE ANTENNAS</i> .....	14
5.6.	<i>SUPPORT UNITS FOR SYSTEM TEST</i> .....	15
5.7.	<i>SETUP DIAGRAM</i> .....	15
<b>6.</b>	<b>MEASURING EQUIPMENT AND SOFTWARE USED</b> .....	<b>17</b>
<b>7.</b>	<b>ANTENNA PORT TEST RESULTS</b> .....	<b>19</b>
7.1.	<i>ON TIME AND DUTY CYCLE</i> .....	19
7.2.	<i>6dB AND 26dB EMISSION BANDWIDTH AND 99% OCCUPIED BANDWIDTH</i> .....	20
7.3.	<i>CONDUCTED OUTPUT POWER</i> .....	22
7.4.	<i>POWER SPECTRAL DENSITY</i> .....	25
7.5.	<i>FREQUENCY STABILITY</i> .....	27
7.6.	<i>Dynamic Frequency Selection (Master)</i> .....	29
<b>8.</b>	<b>RADIATED TEST RESULTS</b> .....	<b>33</b>
8.1.	<i>Radiated Emissions and Band Edge Measurement</i> .....	41
<b>9.</b>	<b>AC POWER LINE CONDUCTED EMISSION</b> .....	<b>69</b>
<b>10.</b>	<b>ANTENNA REQUIREMENT</b> .....	<b>72</b>
<b>APPENDIX: PHOTOGRAPHS OF TEST CONFIGURATION</b> .....		<b>74</b>

# 1. ATTESTATION OF TEST RESULTS

## Applicant Information

Company Name: FS.COM Inc.  
 Address: 380 Centerpoint Blvd, New Castle,DE 19720, United States

## Manufacturer Information

Company Name: FS.COM Inc.  
 Address: 380 Centerpoint Blvd, New Castle,DE 19720, United States

## EUT Information

Product Description: Indoor Access Point  
 Model: AP-N515  
 Brand:   
 Sample Received Date: March 21, 2023  
 Sample Status: Normal  
 Sample ID: A23010057 003  
 Date of Tested: May 10, 2023 to February 19, 2024

APPLICABLE STANDARDS	
STANDARD	TEST RESULTS
CFR 47 FCC PART 15 SUBPART E ISED RSS-247 ISSUE 3 (U-NII)	Pass

Prepared By:



Jack Yang  
 Project Engineer

Approved By:



Shawn Wen  
 Laboratory Manager

Checked By:



Alan He  
 Laboratory Leader



## 2. TEST METHODOLOGY

All tests were performed in accordance with the standard CFR 47 FCC PART 15 SUBPART E ISED RSS-247 ISSUE 3 (U-NII)

## 3. FACILITIES AND ACCREDITATION

Accreditation Certificate	<p><b>A2LA (Certificate No.: 6947.01)</b> Guangdong Global Testing Technology Co., Ltd. has been assessed and proved to be in compliance with A2LA.</p> <p><b>FCC (FCC Designation No.: CN1343)</b> Guangdong Global Testing Technology Co., Ltd. has been recognized to perform compliance testing on equipment subject to Supplier's Declaration of Conformity (SDoC) and Certification rules</p> <p><b>ISED (Company No.: 30714)</b> Guangdong Global Testing Technology Co., Ltd. has been registered and fully described in a report filed with ISED. The Company Number is 30714 and the test lab Conformity Assessment Body Identifier (CABID) is CN0148.</p>
---------------------------	--

Note: All tests measurement facilities use to collect the measurement data are located at Room 101-105, 203-210, Building 1, No.2, Keji 8 Road, Songshan Lake Park, Dongguan city, Guangdong, People's Republic of China, 523808

## 4. CALIBRATION AND UNCERTAINTY

### 4.1. MEASURING INSTRUMENT CALIBRATION

The measuring equipment utilized to perform the tests documented in this report has been calibrated in accordance with the manufacturer's recommendations and is traceable to recognized national standards.

### 4.2. MEASUREMENT UNCERTAINTY

Where relevant, the following measurement uncertainty levels have been estimated for tests performed on the apparatus:

Test Items	k	Uncertainty
Emission Bandwidth	1.96	±9.0 PPM
Conduct Output Power	1.96	± 1.12 dB
Power Spectral Density	1.96	± 2.1 dB
Conducted Spurious Emission	1.96	9 kHz-30 MHz: ± 0.95 dB 30 MHz-1 GHz: ± 1.5 dB 1GHz-12.75GHz: ± 1.8 dB 12.75 GHz-26.5 GHz: ± 2.1dB 26.5 GHz-40 GHz: ± 2.6 dB
Frequency Stability	1.96	±9.0 PPM
Note: This uncertainty represents an expanded uncertainty expressed at approximately the 95% confidence level using a coverage factor of k=1.96.		

Test Item	Frequency Range	k	U(dB)
Conducted emissions from the AC mains power ports (AMN)	150 kHz ~ 30 MHz	2	3.37
Radiated emissions	9 kHz ~ 30 MHz	2	4.16
Radiated emissions	30 MHz ~ 1 GHz	2	3.79
Radiated emissions	1 GHz ~ 18 GHz	2	5.62
Radiated emissions	18 GHz ~ 40 GHz	2	5.54
Note: This uncertainty represents an expanded uncertainty expressed at approximately the 95% confidence level using a coverage factor of k=2.			

## 5. EQUIPMENT UNDER TEST

### 5.1. DESCRIPTION OF EUT

EUT Name		Indoor Access Point
Model		AP-N515
Hardware Version		V1.0
Software Version		V1.0
Ratings		DC 54V / POE 54V
Power Supply	DC	54V

Frequency Band:	5150 MHz to 5250 MHz (U-NII-1) 5250 MHz to 5350 MHz (U-NII-2A) 5725 MHz to 5850 MHz (U-NII-3)
Frequency Range:	5180 MHz to 5240 MHz 5260 MHz to 5320 MHz 5745 MHz to 5825 MHz
Support Standards:	IEEE 802.11a/n/ac/ax
TPC Function:	Support
DFS Operational mode:	Master
Type of Modulation:	IEEE 802.11a: OFDM(64QAM, 16QAM, QPSK, BPSK) IEEE 802.11n: OFDM(64QAM, 16QAM, QPSK, BPSK) IEEE 802.11ac: OFDM(256QAM, 64QAM, 16QAM, QPSK, BPSK) IEEE 802.11ax: OFDMA (1024QAM, 256QAM, 64QAM, 16QAM, QPSK, BPSK)
Channel Spacing:	IEEE 802.11a/n HT20/ac VHT20/ax HE20: 20 MHz IEEE 802.11n HT40/ac VHT40/ax HE40: 40 MHz IEEE 802.11ac VHT80/ax HE80: 80 MHz IEEE 802.11ac VHT160/ax HE160: 160 MHz
Data Rate:	IEEE 802.11a: Up to 54 Mbps IEEE 802.11n HT20: Up to MCS31 IEEE 802.11n HT40: Up to MCS31 IEEE 802.11ac VHT20: Up to MCS9 IEEE 802.11ac VHT40: Up to MCS9 IEEE 802.11ac VHT80: Up to MCS9 IEEE 802.11ac VHT160: Up to MCS9 IEEE 802.11ax HE20: Up to MCS11 IEEE 802.11ax HE40: Up to MCS11 IEEE 802.11ax HE80: Up to MCS11 IEEE 802.11ax HE160: Up to MCS11
Number of Channels:	5150 MHz to 5250 MHz: 4 for IEEE 802.11a/n HT20/ac VHT20/ax HE20 2 for IEEE 802.11n HT40/ac VHT40/ax HE40 1 for IEEE 802.11ac VHT80/ax HE80 5150 MHz to 5350 MHz: 1 for IEEE 802.11ac VHT160/ax HE160 5250 MHz to 5350 MHz: 4 for IEEE 802.11a/n HT20/ac VHT20/ax HE20 2 for IEEE 802.11n HT40/ac VHT40/ax HE40 1 for IEEE 802.11acVHT80/ax HE80



	<p>5725 MHz to 5850 MHz:                      5 for IEEE 802.11a/n HT20/ac VHT20/ax HE20                      2 for IEEE 802.11n HT40/ac VHT40/ax HE40                      1 for IEEE 802.11ac VHT80/ax HE80</p>
Maximum conducted output power:	<p>U-NII-1                      IEEE 802.11a: 11.9 dBm                      IEEE 802.11n HT20: 14.53 dBm                      IEEE 802.11n HT40: 10.12 dBm                      IEEE 802.11ac VHT20: 14.4 dBm                      IEEE 802.11ac VHT40: 10.06 dBm                      IEEE 802.11ac VHT80: 9.96 dBm                      IEEE 802.11ax HE20: 14.75 dBm                      IEEE 802.11ax HE40: 10.25 dBm                      IEEE 802.11ax HE80: 10.07 dBm                      U-NII-1 &amp; U-NII-2A                      IEEE 802.11ac VHT160: 9.27 dBm                      IEEE 802.11ax VHT160: 9.63 dBm                      U-NII-2A                      IEEE 802.11a: 11.73 dBm                      IEEE 802.11n HT20: 14.99 dBm                      IEEE 802.11n HT40: 9.21 dBm                      IEEE 802.11ac VHT20: 14.9 dBm                      IEEE 802.11ac VHT40: 9.13 dBm                      IEEE 802.11ac VHT80: 9.45 dBm                      IEEE 802.11ax HE20: 15.15 dBm                      IEEE 802.11ax HE40: 9.72 dBm                      IEEE 802.11ax HE80: 9.86 dBm                      U-NII-3                      IEEE 802.11a: 11.62 dBm                      IEEE 802.11n HT20: 17.1 dBm                      IEEE 802.11n HT40: 16.91 dBm                      IEEE 802.11ac VHT20: 17.1 dBm                      IEEE 802.11ac VHT40: 16.96 dBm                      IEEE 802.11ac VHT80: 8.6 dBm                      IEEE 802.11ax HE20: 17.39 dBm                      IEEE 802.11ax HE40: 17.26 dBm                      IEEE 802.11ax HE80: 8.87 dBm</p>
Antenna Type:	Internal Antenna
Antenna Gain:	<p>4.17 dBi for antenna 1                      4.17 dBi for antenna 2                      4.17 dBi for antenna 3                      4.17 dBi for antenna 4</p>
EUT Test software:	accessMtool

**5.2. CHANNEL LIST**

UNII-1 (For Bandwidth = 20 MHz)		UNII-1 (For Bandwidth = 40 MHz)		UNII-1 (For Bandwidth = 80 MHz)		UNII-1 & UNII-2A (For Bandwidth = 160 MHz)	
Channel	Frequency (MHz)	Channel	Frequency (MHz)	Channel	Frequency (MHz)	Channel	Frequency (MHz)
36	5180	38	5190	42	5210	50	5250
40	5200	46	5230				
44	5220						
48	5240						

UNII-2A (For Bandwidth = 20 MHz)		UNII-2A (For Bandwidth = 40 MHz)		UNII-2A (For Bandwidth = 80 MHz)	
Channel	Frequency (MHz)	Channel	Frequency (MHz)	Channel	Frequency (MHz)
52	5260	54	5270	58	5290
56	5280	62	5310		
60	5300				
64	5320				

UNII-3 (For Bandwidth=20MHz)		UNII-3 (For Bandwidth=40MHz)		UNII-3 (For Bandwidth=80MHz)	
Channel	Frequency (MHz)	Channel	Frequency (MHz)	Channel	Frequency (MHz)
149	5745	151	5755	155	5775
153	5765	159	5795		
157	5785				
161	5805				
165	5825				

**5.3. MAXIMUM AVERAGE EIRP**

**UNII-1 BAND(FCC&ISED)**

IEEE Std. 802.11	Frequency (MHz)	Maximum Average Conducted Power (dBm)	Max Average EIRP (dBm)
a	5150 ~ 5250	11.9	16.07
n HT20		14.53	18.7
n HT40		10.12	14.29
ac VHT20		14.4	18.57
ac VHT40		10.06	14.23
ac VHT80		9.96	14.13
ax HE20		14.75	18.92
ax HE40		10.25	14.42
ax HE80		10.07	14.24

**UNII-1 & UNII-2A BAND(FCC&ISED)**

IEEE Std. 802.11	Frequency (MHz)	Maximum Average Conducted Power (dBm)	Max Average EIRP (dBm)
ac VHT160	5150 ~ 5350	9.27	13.44
ax HE160		9.63	13.8

**UNII-2A BAND(FCC&ISED)**

IEEE Std. 802.11	Frequency (MHz)	Maximum Average Conducted Power(dBm)	Max Average EIRP (dBm)
a	5250 ~ 5350	11.73	15.9
n HT20		14.99	19.16
n HT40		9.21	13.38
ac VHT20		14.9	19.07
ac VHT40		9.13	13.3
ac VHT80		9.45	13.62
ax HE20		15.15	19.32
ax HE40		9.72	13.89
ax HE80		9.86	14.03

**UNII-3 BAND(FCC&ISED)**

IEEE Std. 802.11	Frequency (MHz)	Maximum Average Conducted Power(dBm)	Max Average EIRP (dBm)
a	5725 ~ 5850	11.62	15.79
n HT20		17.1	21.27
n HT40		16.91	21.08
ac VHT20		17.1	21.27
ac VHT40		16.96	21.13
ac VHT80		8.6	12.77
ax HE20		17.39	21.56
ax HE40		17.26	21.43
ax HE80		8.87	13.04

**5.4. THE WORSE CASE POWER SETTING PARAMETER**

The Worse Case Power Setting Parameter	
Test Software	accessMtool

**UNII-1**

Mode	Rate	Channel	Soft set value			
			ANT 1	ANT 2	ANT 3	ANT 4
11a	6M	36	55	55	55	55
		40	55	55	55	55
		48	55	55	55	55
11n HT20	MCS24	36	45	45	45	45
		40	45	45	45	45
		48	45	45	45	45
11n HT40	MCS24	38	23	23	23	23

		46	23	23	23	23
11ac VHT20	MCS0	36	45	45	45	45
		40	45	45	45	45
		48	45	45	45	45
11ac VHT40	MCS0	38	23	23	23	23
		46	23	23	23	23
11ac VHT80	MCS0	42	23	23	23	23
11ax HE20	MCS0	36	45	45	45	45
		40	45	45	45	45
		48	45	45	45	45
11ax HE40	MCS0	38	25	25	25	25
		46	25	25	25	25
11ax HE80	MCS0	42	25	25	25	25

UNII-1 & UNII-2A

Mode	Rate	Channel	Soft set value			
			ANT 1	ANT 2	ANT 3	ANT 4
11ac VHT160	MCS0	50	23	23	23	23
11ax HE160	MCS0	50	25	25	25	25

UNII-2A

Mode	Rate	Channel	Soft set value			
			ANT 1	ANT 2	ANT 3	ANT 4
11a	6M	52	53	53	53	53
		56	53	53	53	53
		64	50	50	50	50
11n HT20	MCS24	52	45	45	45	45
		56	45	45	45	45
		64	45	45	45	45
11n HT40	MCS24	54	21	21	21	21
		62	21	21	21	21
11ac VHT20	MCS0	52	45	45	45	45
		56	45	45	45	45
		64	45	45	45	45
11ac VHT40	MCS0	54	21	21	21	21
		62	21	21	21	21
11ac VHT80	MCS0	58	23	23	23	23
11ax HE20	MCS0	52	45	45	45	45
		56	45	45	45	45
		64	45	45	45	45
11ax HE40	MCS0	54	22	22	22	22
		62	22	22	22	22
11ax HE80	MCS0	58	25	25	25	25

UNII-3

Mode	Rate	Channel	Soft set value			
			ANT1	ANT 2	ANT3	ANT 4
11a	6M	149	50	50	50	50
		157	50	50	50	50
		165	50	50	50	50
11n HT20	MCS24	149	50	50	50	50

		157	50	50	50	50
		165	50	50	50	50
11n HT40	MCS24	151	58	58	58	58
		159	58	58	58	58
11ac VHT20	MCS0	149	50	50	50	50
		157	50	50	50	50
		165	50	50	50	50
11ac VHT40	MCS0	151	58	58	58	58
		159	58	58	58	58
11ac VHT80	MCS0	155	23	23	23	23
11ax HE20	MCS0	149	50	50	50	50
		157	50	50	50	50
		165	50	50	50	50
11ax HE40	MCS0	151	58	58	58	58
		159	58	58	58	58
11ax HE80	MCS0	155	25	25	25	25

## THE WORSE CASE CONFIGURATIONS

The EUT was tested in the following configuration(s):

Controlled in test mode using a software application on the EUT supplied by customer. The application was used to enable a continuous transmission and to select the mode, test channels, bandwidth, data rates as required.

Test channels referring to section 5.4.

Maximum power setting referring to section 5.4.

Worst case Data Rates declared by the customer:

802.11a 20 mode: 6 Mbps  
 802.11n HT20 mode: MCS24  
 802.11n HT40 mode: MCS24  
 802.11ac VHT20 mode: MCS0  
 802.11ac VHT40 mode: MCS0  
 802.11ac VHT80 mode: MCS0  
 802.11ac VHT160 mode: MCS0  
 802.11ax HE20 mode: MCS0  
 802.11ax HE40 mode: MCS0  
 802.11ax HE80 mode: MCS0  
 802.11ax HE160 mode: MCS0

### 5.5. DESCRIPTION OF AVAILABLE ANTENNAS

Antenna No.	Frequency Band	Antenna Type	Max Antenna Gain (dBi)
1	5150-5350	Internal Antenna	4.17
1	5725-5850	Internal Antenna	4.17
2	5150-5350	Internal Antenna	4.17
2	5725-5850	Internal Antenna	4.17
3	5150-5350	Internal Antenna	4.17
3	5725-5850	Internal Antenna	4.17
4	5150-5350	Internal Antenna	4.17
4	5725-5850	Internal Antenna	4.17

MIMO output power port and MIMO PSD port summing were performed in accordance with KDB 662911 D01. For the MIMO results the Directional Gain was calculated in accordance with the following method.

For output power measurements:

$$\text{Directional gain} = G_{\text{ANT}} + \text{Array Gain} = (4.17 + 0) \text{ dBi} = 4.17 \text{ dBi}$$

Note:

$G_{\text{ANT}}$ : Antenna gain.

Array Gain = 0 dB for  $N_{\text{ANT}} \leq 4$  when all antennas have the same gain.

$N_{\text{ANT}}$ : the total number of antennas.

For power spectral density (PSD) measurements:

Directional gain =  $G_{ANT} + \text{Array Gain} = (4.17 + 6.02) \text{ dBi} = 10.19\text{dBi}$

Note:

$G_{ANT}$ : Antenna gain.

Array Gain =  $10\log(N_{ANT}/N_{SS}) \text{ dB} = 10\log(4/1) \text{ dB} = 6.02\text{dB}$  .

IEE Std. 802.11	Transmit and Receive Mode	Description
802.11a	☒4TX, 4RX	Antenna 1, Antenna 2, Antenna 3 and Antenna 4 can be used as transmitting/receiving antenna.
802.11n HT20	☒4TX, 4RX	Antenna 1, Antenna 2, Antenna 3 and Antenna 4 can be used as transmitting/receiving antenna.
802.11n HT40	☒4TX, 4RX	Antenna 1, Antenna 2, Antenna 3 and Antenna 4 can be used as transmitting/receiving antenna.
802.11ac VHT20	☒4TX, 4RX	Antenna 1, Antenna 2, Antenna 3 and Antenna 4 can be used as transmitting/receiving antenna.
802.11ac VHT40	☒4TX, 4RX	Antenna 1, Antenna 2, Antenna 3 and Antenna 4 can be used as transmitting/receiving antenna.
802.11ac VHT80	☒4TX, 4RX	Antenna 1, Antenna 2, Antenna 3 and Antenna 4 can be used as transmitting/receiving antenna.
802.11ac VHT160	☒4TX, 4RX	Antenna 1, Antenna 2, Antenna 3 and Antenna 4 can be used as transmitting/receiving antenna.
802.11ax HE20	☒4TX, 4RX	Antenna 1, Antenna 2, Antenna 3 and Antenna 4 can be used as transmitting/receiving antenna.
802.11ax HE40	☒4TX, 4RX	Antenna 1, Antenna 2, Antenna 3 and Antenna 4 can be used as transmitting/receiving antenna.
802.11ax HE80	☒4TX, 4RX	Antenna 1, Antenna 2, Antenna 3 and Antenna 4 can be used as transmitting/receiving antenna.
802.11ax HE160	☒4TX, 4RX	Antenna 1, Antenna 2, Antenna 3 and Antenna 4 can be used as transmitting/receiving antenna.

### 5.6. SUPPORT UNITS FOR SYSTEM TEST

Equipment	Manufacturer	Model No.
Adapter	Lulian	CD170
PC	Lenovo	T14

### 5.7. SETUP DIAGRAM

AC conducted emission :

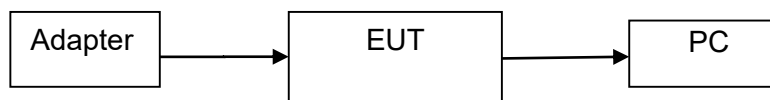

Radiated Emission:



RF conducted:

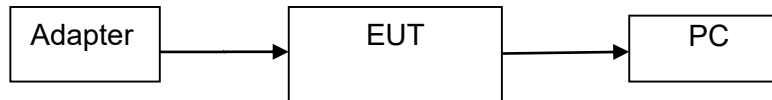



## 6. MEASURING EQUIPMENT AND SOFTWARE USED

Test Equipment of Conducted RF					
Equipment	Manufacturer	Model No.	Serial No.	Last Cal.	Due Date
Spectrum Analyzer	Rohde & Schwarz	FSV40	102257	2023/09/18	2024/09/17
Spectrum Analyzer	KEYSIGHT	N9020A	MY51285127	2023/09/18	2024/09/17
EXG Analog Signal Generator	KEYSIGHT	N5173B	MY61253075	2023/09/18	2024/09/17
Vector Signal Generator	Rohde & Schwarz	SMM100A	101899	2023/09/18	2024/09/17
RF Control box	MWRF-test	MW100-RFCB	MW220926GTG	2023/09/18	2024/09/17
Wideband Radio Communication Tester	Rohde & Schwarz	CMW270	102792	2023/09/18	2024/09/17
Wideband Radio Communication Tester	Rohde & Schwarz	CMW500	103235	2023/09/18	2024/09/17
temperature humidity chamber	Espec	SH-241	SH-241-2014	2023/09/18	2024/09/17
RF Test Software	MWRF-test	MTS8310E (Ver. V2/0)	N/A	N/A	N/A

Test Equipment of Radiated emissions below 1GHz					
Equipment	Manufacturer	Model No.	Serial No.	Last Cal.	Due Date
3m Semi-anechoic Chamber	ETS	9m*6m*6m	Q2146	2022/08/30	2025/08/29
EMI Test Receiver	Rohde & Schwarz	ESCI3	101409	2023/09/18	2024/09/17
Spectrum Analyzer	KEYSIGHT	N9020A	MY51283932	2023/09/18	2024/09/17
Pre-Amplifier	HZEMC	HPA-9K0130	HYP A21001	2023/09/18	2024/09/17
Biconilog Antenna	Schwarzbeck	VULB 9168	01315	2022/10/10	2025/10/09
Biconilog Antenna	ETS	3142E	00243646	2022/03/23	2025/03/22
Loop Antenna	ETS	6502	243668	2022/03/30	2025/03/29
Test Software	Farad	EZ-EMC (Ver.FA-03A2 RE)	N/A	N/A	N/A

Test Equipment of Radiated emissions above 1GHz					
Equipment	Manufacturer	Model No.	Serial No.	Last Cal.	Due Date
3m Semi-anechoic Chamber	ETS	9m*6m*6m	Q2149	2022/08/30	2025/08/29
Spectrum Analyzer	Rohde & Schwarz	FSV40	101413	2023/09/18	2024/09/17
Spectrum Analyzer	KEYSIGHT	N9020A	MY51283932	2023/09/18	2024/09/17
Pre-Amplifier	A-INFO	HPA-1G1850	HYP A21003	2023/09/18	2024/09/17
Horn antenna	A-INFO	3117	246069	2022/03/11	2025/03/10
Pre-Amplifier	ZKJC	HPA-184057	HYP A21004	2023/09/18	2024/09/17

Horn antenna	ZKJC	3116C	246265	2022/03/29	2025/03/28
Test Software	Farad	EZ-EMC (Ver.FA-03A2 RE+)	N/A	N/A	N/A

<b>Test Equipment of Conducted emissions</b>					
<b>Equipment</b>	<b>Manufacturer</b>	<b>Model No.</b>	<b>Serial No.</b>	<b>Last Cal.</b>	<b>Due Date</b>
Shielded Room	CHENG YU	8m*5m*4m	N/A	2022/10/29	2025/10/28
EMI Test Receiver	Rohde & Schwarz	ESR3	102647	2023/09/18	2024/09/17
LISN/AMN	Rohde & Schwarz	ENV216	102843	2023/09/18	2024/09/17
NNLK 8129 RC	Schwarzbeck	NNLK 8129 RC	5046	2023/09/18	2024/09/17
Test Software	Farad	EZ-EMC (Ver. EMC-con-3A1 1+)	N/A	N/A	N/A

## 7. ANTENNA PORT TEST RESULTS

### 7.1. ON TIME AND DUTY CYCLE

#### LIMITS

None; for reporting purposes only.

#### TEST PROCEDURE

Refer to KDB 789033 D02 General U-NII Test Procedures New Rules v02r01 section II.B.

The zero-span mode on a spectrum analyzer or EMI receiver, if the response time and spacing between bins on the sweep are sufficient to permit accurate measurements of the on and off times of the transmitted signal. Set the center frequency of the instrument to the center frequency of the transmission. Set  $RBW \geq EBW$  if possible; otherwise, set RBW to the largest available value. Set  $VBW \geq RBW$ . Set detector = peak or average. The zero-span measurement method shall not be used unless both RBW and VBW are  $> 50/T$ , where T is defined in II.B.1.a), and the number of sweep points across duration T exceeds 100. (For example, if VBW and/or RBW are limited to 3 MHz, then the zero-span method of measuring duty cycle shall not be used if  $T \leq 16.7$  microseconds.)

#### TEST SETUP

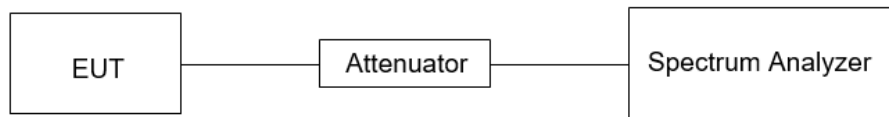

#### TEST ENVIRONMENT

Temperature	24.3°C	Relative Humidity	54%
Atmosphere Pressure	101kPa		

#### TEST RESULTS

Please refer to section "Test Data" - Appendix A

## 7.2. 6DB AND 26DB EMISSION BANDWIDTH AND 99% OCCUPIED BANDWIDTH

### LIMITS

CFR 47 FCC Part15, Subpart E ISED RSS-247 ISSUE 3		
Test Item	Limit	Frequency Range (MHz)
26 dB Emission Bandwidth	For reporting purposes only.	5150 ~ 5250
26 dB Emission Bandwidth	For reporting purposes only.	5250 ~ 5350
26 dB Emission Bandwidth	For reporting purposes only.	5470 ~ 5725 (For FCC) 5470 ~ 5600 (For ISED) 5650 ~ 5725 (For ISED)
6 dB Emission Bandwidth	The minimum 6 dB emission bandwidth shall be 500 kHz.	5725 ~ 5850
99 % Occupied Bandwidth	For reporting purposes only.	5150 ~ 5850 (For ISED)

### TEST PROCEDURE

Refer to KDB 789033 D02 General U-NII Test Procedures New Rules v02r01 section II.C1. for 26 dB Emission Bandwidth; section II.C2. for 6 dB Emission Bandwidth; section II.D. for 99 % Occupied Bandwidth.

Connect the EUT to the spectrum analyser and use the following settings:

Center Frequency	The center frequency of the channel under test
Detector	Peak
RBW	For 6 dB Emission Bandwidth: RBW=100 kHz For 26 dB Emission bandwidth: approximately 1 % of the EBW. For 99 % Occupied Bandwidth: approximately 1 % ~ 5 % of the OBW.
VBW	For 6 dB Bandwidth: $\geq 3 \cdot \text{RBW}$ For 26 dB Bandwidth: $> 3 \cdot \text{RBW}$ For 99 % Bandwidth: $> 3 \cdot \text{RBW}$
Trace	Max hold
Sweep	Auto couple

- a) Use the 99 % power bandwidth function of the instrument, allow the trace to stabilize and report the measured bandwidth.
- b) Allow the trace to stabilize and measure the maximum width of the emission that is constrained by the frequencies associated with the two outermost amplitude points (upper and lower frequencies) that are attenuated by 6/26 dB relative to the maximum level measured in the fundamental emission.

**TEST SETUP**

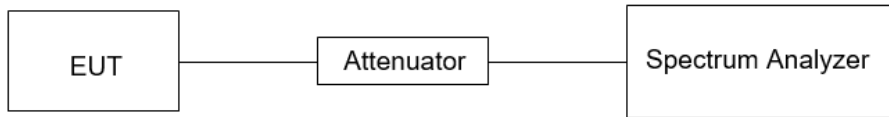

**TEST ENVIRONMENT**

Temperature	24.3°C	Relative Humidity	54%
Atmosphere Pressure	101kPa		

**TEST RESULTS**

Please refer to section "Test Data" - Appendix A

### 7.3. CONDUCTED OUTPUT POWER

#### LIMITS

CFR 47 FCC Part15, Subpart E		
Test Item	Limit	Frequency Range (MHz)
Conducted Output Power	<input type="checkbox"/> Outdoor Access Point: 1 W (30 dBm) <input checked="" type="checkbox"/> Indoor Access Point: 1 W (30 dBm) <input type="checkbox"/> Fixed Point-To-Point Access Points: 1 W (30 dBm) <input type="checkbox"/> Client Devices: 250 mW (24 dBm)	5150 ~ 5250
	Shall not exceed the lesser of 250 mW (24dBm) or 11 dBm + 10 log B, where B is the 26 dB emission bandwidth in megahertz.	5250 ~ 5350 5470 ~ 5725
	Shall not exceed 1 Watt (30 dBm).	5725 ~ 5850

ISED RSS-247 ISSUE 3		
Test Item	Limit	Frequency Range (MHz)
Conducted Output Power or e.i.r.p.	The maximum e.i.r.p. shall not exceed 200 mW (23 dBm) or 10 + 10 log <sub>10</sub> B, dBm, whichever power is less. B is the 99 % emission bandwidth in megahertz.	5150 ~ 5250
	a. The maximum conducted output power shall not exceed 250 mW (24 dBm) or 11 + 10 log <sub>10</sub> B dBm, whichever is less.  b. The maximum e.i.r.p. shall not exceed 1.0 W (30 dBm) or 17 + 10 log <sub>10</sub> B dBm, whichever is less. B is the 99 % emission bandwidth in megahertz. Note that devices with a maximum e.i.r.p. greater than 500 mW shall implement TPC in order to have the capability to operate at least 6 dB below the maximum permitted e.i.r.p. of 1 W.	5250 ~ 5350 5470 ~ 5600 5650 ~ 5725
	Shall not exceed 1 Watt (30 dBm).	5725 ~ 5850

**Note:**

The above limits are based upon the maximum antenna gain does not exceed 6 dBi. If transmitting antennas of directional gain greater than 6 dBi are used, the maximum conducted output power shall be reduced by the amount in dB that the directional gain of the antenna exceeds 6 dBi.

#### TEST PROCEDURE

Refer to KDB 789033 D02 General U-NII Test Procedures New Rules v02r01 section II.E.

**Method SA-1 (trace averaging with the EUT transmitting at full power throughout each sweep):**

- (i) Set span to encompass the entire emission bandwidth (EBW) (or, alternatively, the entire 99% occupied bandwidth) of the signal.
- (ii) Set RBW = 1 MHz.
- (iii) Set VBW ≥ 3 MHz.

- (iv) Number of points in sweep  $\geq 2 \times \text{span} / \text{RBW}$ . (This ensures that bin-to-bin spacing is  $\leq \text{RBW}/2$ , so that narrowband signals are not lost between frequency bins.)
- (v) Sweep time = auto.
- (vi) Detector = power averaging (rms), if available. Otherwise, use sample detector mode.
- (vii) If transmit duty cycle  $< 98\%$ , use a video trigger with the trigger level set to enable triggering only on full power pulses. Transmitter must operate at maximum power control level for the entire duration of every sweep. If the EUT transmits continuously (i.e., with no off intervals) or at duty cycle  $\geq 98\%$ , and if each transmission is entirely at the maximum power control level, then the trigger shall be set to “free run.”
- (viii) Trace average at least 100 traces in power averaging (rms) mode.
- (ix) Compute power by integrating the spectrum across the EBW (or, alternatively, the entire 99% occupied bandwidth) of the signal using the instrument’s band power measurement function with band limits set equal to the EBW (or occupied bandwidth) band edges. If the instrument does not have a band power function, sum the spectrum levels (in power units) at 1 MHz intervals extending across the EBW (or, alternatively, the entire 99% occupied bandwidth) of the spectrum.

**Method PM (Measurement using an RF average power meter):**

- (i) Measurements may be performed using a wideband RF power meter with a thermocouple detector or equivalent if all of the following conditions are satisfied:
  - a. The EUT is configured to transmit continuously or to transmit with a constant duty cycle.
  - b. At all times when the EUT is transmitting, it must be transmitting at its maximum power control level.
  - c. The integration period of the power meter exceeds the repetition period of the transmitted signal by at least a factor of five.
- (ii) If the transmitter does not transmit continuously, measure the duty cycle, x, of the transmitter output signal as described in II.B.
- (iii) Measure the average power of the transmitter. This measurement is an average over both the on and off periods of the transmitter.
- (iv) Adjust the measurement in dBm by adding  $10 \log (1/x)$  where x is the duty cycle (e.g.,  $10 \log (1/0.25)$  if the duty cycle is 25 %).

**Method PM-G (Measurement using a gated RF average power meter):**

Measurements may be performed using a wideband gated RF power meter provided that the gate parameters are adjusted such that the power is measured only when the EUT is transmitting at its maximum power control level. Since the measurement is made only during the ON time of the transmitter, no duty cycle correction factor is required.

Straddle channel power was measured using spectrum analyzer.

**TEST SETUP**

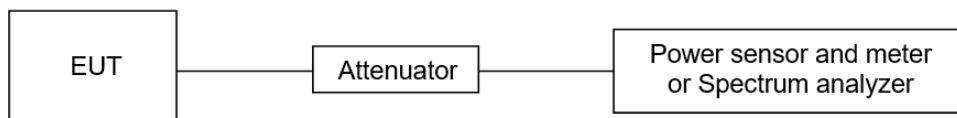

**TEST ENVIRONMENT**

Temperature	24.3°C	Relative Humidity	54%
Atmosphere Pressure	101kPa		

**TEST RESULTS**

Please refer to section "Test Data" - Appendix A



### 7.4. POWER SPECTRAL DENSITY

**LIMITS**

CFR 47 FCC Part15, Subpart E		
Test Item	Limit	Frequency Range (MHz)
Power Spectral Density	<input type="checkbox"/> Outdoor Access Point: 17 dBm/MHz <input checked="" type="checkbox"/> Indoor Access Point: 17 dBm/MHz <input type="checkbox"/> Fixed Point-To-Point Access Points: 17 dBm/MHz <input type="checkbox"/> Client Devices: 11 dBm/MHz	5150 ~ 5250
	11 dBm/MHz	5250 ~ 5350 5470 ~ 5725
	30 dBm/500kHz	5725 ~ 5850

ISED RSS-247 ISSUE 3		
Test Item	Limit	Frequency Range (MHz)
Power Spectral Density	The e.i.r.p. spectral density shall not exceed 10 dBm in any 1.0 MHz band.	5150 ~ 5250
	The power spectral density shall not exceed 11 dBm in any 1.0 MHz band.	5250 ~ 5350 5470 ~ 5600 5650 ~ 5725
	30 dBm / 500 kHz	5725 ~ 5850

Note:

The above limits are based upon the maximum antenna gain does not exceed 6 dBi. If transmitting antennas of directional gain greater than 6 dBi are used, maximum power spectral density shall be reduced by the amount in dB that the directional gain of the antenna exceeds 6 dBi.

**TEST PROCEDURE**

Refer to KDB 789033 D02 General U-NII Test Procedures New Rules v02r01 section II.F.

Connect the EUT to the spectrum analyser and use the following settings:

For U-NII-1, U-NII-2A and U-NII-2C band:

Center Frequency	The center frequency of the channel under test
Detector	RMS
RBW	1 MHz
VBW	$\geq 3 \times \text{RBW}$
Span	Encompass the entire emissions bandwidth (EBW) of the signal
Trace	Max hold
Sweep time	Auto

For U-NII-3:

Center Frequency	The center frequency of the channel under test
Detector	RMS
RBW	500 kHz
VBW	$\geq 3 \times \text{RBW}$
Span	Encompass the entire emissions bandwidth (EBW) of the signal
Trace	Max hold
Sweep time	Auto

Allow trace to fully stabilize and Use the peak search function on the instrument to find the peak of the spectrum and record its value.

Add  $10 \log (1/x)$ , where x is the duty cycle, to the peak of the spectrum, the result is the Maximum PSD over 1 MHz / 500 kHz reference bandwidth.

**TEST SETUP**

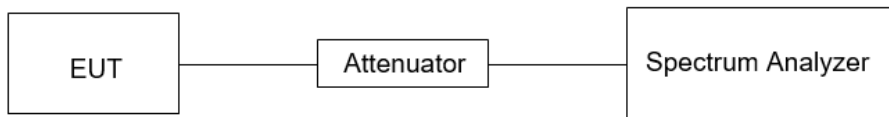

**TEST ENVIRONMENT**

Temperature	24.3°C	Relative Humidity	54%
Atmosphere Pressure	101kPa		

**TEST RESULTS**

Please refer to section "Test Data" - Appendix A

## 7.5. FREQUENCY STABILITY

### LIMITS

The frequency of the carrier signal shall be maintained within band of operation.

### TEST PROCEDURE

1. The EUT was placed inside an environmental chamber as the temperature in the chamber was varied between -10 °C ~ 50 °C (declared by customer).
2. The temperature was incremented by 10 °C intervals and the unit allowed to stabilize at each temperature before each measurement. The center frequency of the transmitting channel was evaluated at each temperature and the frequency deviation from the channel's center frequency was recorded.
3. The primary supply voltage is varied from 85 % to 115 % of the nominal value for non hand-carried battery and AC powered equipment. For hand-carried, battery-powered equipment, primary supply voltage is reduced to the battery operating end point which shall be specified by the manufacturer.

Connect the EUT to the spectrum analyser and use the following settings:

Center Frequency	The center frequency of the channel under test
Detector	Peak
RBW	10 kHz
VBW	$\geq 3 \times \text{RBW}$
Span	Encompass the entire emissions bandwidth (EBW) of the signal
Trace	Max hold
Sweep time	Auto

4. While maintaining a constant temperature inside the environmental chamber, turn the EUT on and record the operating frequency at startup, and at 2 minutes, 5minutes, and 10 minutes after the EUT is energized.
5. Allow the trace to stabilize, find the peak value of the power envelope and record the frequency, then calculated the frequency drift.

### TEST SETUP

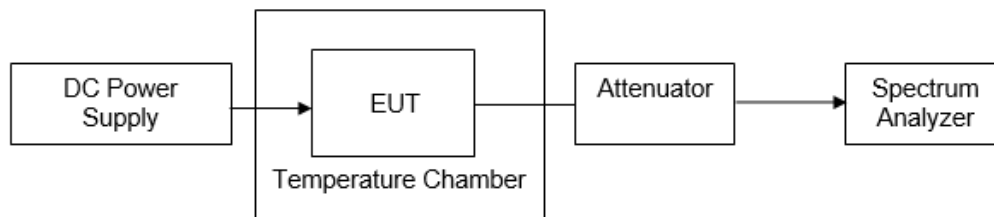

### TEST ENVIRONMENT

Temperature	20°C	Relative Humidity	53%
Atmosphere Pressure	101kPa		

**TEST RESULTS**

Please refer to section "Test Data" - Appendix A

## 7.6. DYNAMIC FREQUENCY SELECTION (MASTER)

### LIMITS

#### (1) DFS Detection Thresholds

Table 3: DFS Detection Thresholds for Master Devices and Client Devices With Radar Detection

Maximum Transmit Power	Value (See Notes 1, 2, and 3)
EIRP ≥ 200 milliwatt	-64 dBm
EIRP < 200 milliwatt and power spectral density < 10 dBm/MHz	-62 dBm
EIRP < 200 milliwatt that do not meet the power spectral density requirement	-64 dBm

Note 1: This is the level at the input of the receiver assuming a 0 dBi receive antenna.  
 Note 2: Throughout these test procedures an additional 1 dB has been added to the amplitude of the test transmission waveforms to account for variations in measurement equipment. This will ensure that the test signal is at or above the detection threshold level to trigger a DFS response.  
 Note3: EIRP is based on the highest antenna gain. For MIMO devices refer to KDB Publication 662911 D01.

#### (2) DFS Response Requirements

Table 4: DFS Response Requirement Values

Parameter	Value
Non-occupancy period	Minimum 30 minutes
Channel Availability Check Time	60 seconds
Channel Move Time	10 seconds See Note 1.
Channel Closing Transmission Time	200 milliseconds + an aggregate of 60 milliseconds over remaining 10 second period. See Notes 1 and 2.
U-NII Detection Bandwidth	Minimum 100% of the U-NII 99% transmission power bandwidth. See Note 3.

Note 1: Channel Move Time and the Channel Closing Transmission Time should be performed with Radar Type 0. The measurement timing begins at the end of the Radar Type 0 burst.  
 Note 2: The Channel Closing Transmission Time is comprised of 200 milliseconds starting at the beginning of the Channel Move Time plus any additional intermittent control signals required facilitating a Channel move (an aggregate of 60 milliseconds) during the remainder of the 10 second period. The aggregate duration of control signals will not count quiet periods in between transmissions.  
 Note 3: During the U-NII Detection Bandwidth detection test, radar type 0 should be used. For each frequency step the minimum percentage of detection is 90 percent. Measurements are performed with no data traffic.

**APPLICABILITY OF DFS REQUIREMENTS**

A U-NII network will employ a DFS function to detect signals from radar systems and to avoid co-channel operation with these systems. This applies to the 5250-5350 MHz and/or 5470-5725 MHz bands.

Within the context of the operation of the DFS function, a U-NII device will operate in either Master Mode or Client Mode. U-NII devices operating in Client Mode can only operate in a network controlled by a U-NII device operating in Master Mode.

Table 1: Applicability of DFS Requirements Prior to Use of a Channel

Requirement	Operational Mode		
	<input checked="" type="checkbox"/> Master	<input type="checkbox"/> Client Without Radar Detection	<input type="checkbox"/> Client With Radar Detection
Non-Occupancy Period	Yes	Not required	Yes
DFS Detection Threshold	Yes	Not required	Yes
Channel Availability Check Time	Yes	Not required	Not required
U-NII Detection Bandwidth	Yes	Not required	Yes

Table 2: Applicability of DFS requirements during normal operation

Requirement	Operational Mode	
	<input checked="" type="checkbox"/> Master Device or Client with Radar Detection	<input type="checkbox"/> Client Without Radar Detection
DFS Detection Threshold	Yes	Not required
Channel Closing Transmission Time	Yes	Yes
Channel Move Time	Yes	Yes
U-NII Detection Bandwidth	Yes	Not required

Additional requirements for devices with multiple bandwidth modes	<input checked="" type="checkbox"/> Master Device or Client with Radar Detection	<input type="checkbox"/> Client Without Radar Detection
U-NII Detection Bandwidth and Statistical Performance Check	All BW modes must be tested	Not required
Channel Move Time and Channel Closing Transmission Time	Test using widest BW mode available	Test using the widest BW mode available for the link
All other tests	Any single BW mode	Not required

Note: Frequencies selected for statistical performance check should include several frequencies within the radar detection bandwidth and frequencies near the edge of the radar detection bandwidth. For 802.11 devices it is suggested to select frequencies in each of the bonded 20 MHz channels and the channel center frequency.

**PARAMETERS OF RADAR TEST WAVEFORMS**

This section provides the parameters for required test waveforms, minimum percentage of successful detections, and the minimum number of trials that must be used for determining DFS conformance. Step intervals of 0.1 microsecond for Pulse Width, 1 microsecond for PRI, 1 MHz for chirp width and 1 for the number of pulses will be utilized for the random determination of specific test waveforms.

Table 5 Short Pulse Radar Test Waveforms

Radar Type	Pulse Width (µsec)	PRI (µsec)	Number of Pulses	Minimum Percentage of Successful Detection	Minimum Number of Trials
0	1	1428	18	See Note 1	See Note 1
1	1	Test A	Roundup $\left\{ \begin{matrix} \frac{1}{360} \\ \frac{19 \cdot 10^6}{PRI_{\mu sec}} \end{matrix} \right\}$	60%	30
		Test B			
2	1-5	150-230	23-29	60%	30
3	6-10	200-500	16-18	60%	30
4	11-20	200-500	12-16	60%	30
Aggregate (Radar Types 1-4)				80%	120
Note 1: Short Pulse Radar Type 0 should be used for the detection bandwidth test, channel move time, and channel closing time tests. Test A: 15 unique PRI values randomly selected from the list of 23 PRI values in Table 5a Test B: 15 unique PRI values randomly selected within the range of 518-3066 µsec, with a minimum increment of 1 µsec, excluding PRI values selected in Test A					

A minimum of 30 unique waveforms are required for each of the Short Pulse Radar Types 2 through 4. If more than 30 waveforms are used for Short Pulse Radar Types 2 through 4, then each additional waveform must also be unique and not repeated from the previous waveforms. If more than 30 waveforms are used for Short Pulse Radar Type 1, then each additional waveform is generated with Test B and must also be unique and not repeated from the previous waveforms in Tests A or B. Test aggregate is average of the percentage of successful detections of short pulse radar types 1-4.

**TEST SETUP**

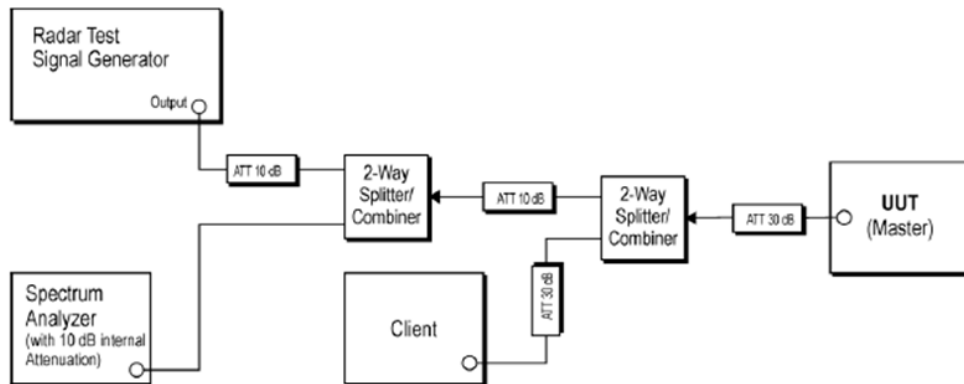

**TEST ENVIRONMENT**

Temperature	24.3°C	Relative Humidity	54%
Atmosphere Pressure	101kPa		

**TEST RESULTS**

Please refer to section "Test Data" - Appendix A



## 8. RADIATED TEST RESULTS

### LIMITS

Refer to CFR 47 FCC §15.205, §15.209 and §15.407 (b).

Refer to ISED RSS-GEN Clause 8.9, Clause 8.10 and ISED RSS-247 6.2.

Radiation Disturbance Test Limit for FCC (Class B) (9 kHz ~ 1 GHz)

Emissions radiated outside of the specified frequency bands above 30 MHz			
Frequency Range (MHz)	Field Strength Limit (uV/m) at 3 m	Field Strength Limit (dBuV/m) at 3 m	
		Quasi-Peak	
30 - 88	100	40	
88 - 216	150	43.5	
216 - 960	200	46	
Above 960	500	54	
Above 1000	500	Peak	Average
		74	54

FCC Emissions radiated outside of the specified frequency bands below 30 MHz		
Frequency (MHz)	Field strength (microvolts/meter)	Measurement distance (meters)
0.009-0.490	2400/F(kHz)	300
0.490-1.705	24000/F(kHz)	30
1.705-30.0	30	30

ISED General field strength limits at frequencies below 30 MHz

Table 6 – General field strength limits at frequencies below 30 MHz		
Frequency	Magnetic field strength (H-Field) (µA/m)	Measurement distance (m)
9 - 490 kHz <sup>Note 1</sup>	6.37/F (F in kHz)	300
490 - 1705 kHz	63.7/F (F in kHz)	30
1.705 - 30 MHz	0.08	30

**Note 1:** The emission limits for the ranges 9-90 kHz and 110-490 kHz are based on measurements employing a linear average detector.

ISED Restricted bands refer to ISED RSS-GEN Clause 8.10

Table 7 – Restricted frequency bands <sup>Note 1</sup>		
MHz	MHz	GHz
0.090 - 0.110	149.9 - 150.05	9.0 - 9.2
0.495 - 0.505	156.52475 - 156.52525	9.3 - 9.5
2.1735 - 2.1905	156.7 - 156.9	10.6 - 12.7
3.020 - 3.026	162.0125 - 167.17	13.25 - 13.4
4.125 - 4.128	167.72 - 173.2	14.47 - 14.5
4.17725 - 4.17775	240 - 285	15.35 - 16.2
4.20725 - 4.20775	322 - 335.4	17.7 - 21.4
5.677 - 5.683	399.9 - 410	22.01 - 23.12
6.215 - 6.218	608 - 614	23.6 - 24.0
6.26775 - 6.26825	960 - 1427	31.2 - 31.8
6.31175 - 6.31225	1435 - 1626.5	36.43 - 36.5
8.291 - 8.294	1645.5 - 1646.5	Above 38.6
8.362 - 8.366	1660 - 1710	
8.37625 - 8.38675	1718.8 - 1722.2	
8.41425 - 8.41475	2200 - 2300	
12.29 - 12.293	2310 - 2390	
12.51975 - 12.52025	2483.5 - 2500	
12.57675 - 12.57725	2655 - 2900	
13.36 - 13.41	3260 - 3267	
16.42 - 16.423	3332 - 3339	
16.69475 - 16.69525	3345.8 - 3358	
16.80425 - 16.80475	3500 - 4400	
25.5 - 25.67	4500 - 5150	
37.5 - 38.25	5350 - 5480	
73 - 74.6	7250 - 7750	
74.8 - 75.2	8025 - 8500	
108 - 138		

**Note 1:** Certain frequency bands listed in table 7 and in bands above 38.6 GHz are designated for licence-exempt applications. These frequency bands and the requirements that apply to related devices are set out in the 200 and 300 series of RSSs.

FCC Restricted bands of operation refer to FCC §15.205 (a):

MHz	MHz	MHz	GHz
0.090-0.110	16.42-16.423	399.9-410	4.5-5.15
<sup>1</sup> 0.495-0.505	16.69475-16.69525	608-614	5.35-5.46
2.1735-2.1905	16.80425-16.80475	960-1240	7.25-7.75
4.125-4.128	25.5-25.67	1300-1427	8.025-8.5
4.17725-4.17775	37.5-38.25	1435-1626.5	9.0-9.2
4.20725-4.20775	73-74.6	1645.5-1646.5	9.3-9.5
6.215-6.218	74.8-75.2	1660-1710	10.6-12.7
6.26775-6.26825	108-121.94	1718.8-1722.2	13.25-13.4
6.31175-6.31225	123-138	2200-2300	14.47-14.5
8.291-8.294	149.9-150.05	2310-2390	15.35-16.2
8.362-8.366	156.52475-156.52525	2483.5-2500	17.7-21.4
8.37625-8.38675	156.7-156.9	2690-2900	22.01-23.12
8.41425-8.41475	162.0125-167.17	3260-3267	23.6-24.0
12.29-12.293	167.72-173.2	3332-3339	31.2-31.8
12.51975-12.52025	240-285	3345.8-3358	36.43-36.5
12.57675-12.57725	322-335.4	3600-4400	( <sup>2</sup> )
13.36-13.41			

Note: <sup>1</sup>Until February 1, 1999, this restricted band shall be 0.490-0.510 MHz.

<sup>2</sup>Above 38.6c

Limits of unwanted/undesirable emission out of the restricted bands refer to CFR 47 FCC §15.407 (b) and ISED RSS-247 6.2.

LIMITS OF RADIATED EMISSION MEASUREMENT (Above 1GHz)

Frequency Range (MHz)	EIRP Limit	Field Strength Limit (dBuV/m) at 3 m
5150~5250 MHz	PK: -27 (dBm/MHz)	PK:68.2(dBμV/m)
5250~5350 MHz		
5470~5725 MHz		
5725~5850 MHz	PK: -27 (dBm/MHz) *1 PK: 10 (dBm/MHz) *2 PK: 15.6 (dBm/MHz) *3 PK: 27 (dBm/MHz) *4	PK: 68.2(dBμV/m) *1 PK: 105.2 (dBμV/m) *2 PK: 110.8(dBμV/m) *3 PK: 122.2 (dBμV/m) *4
<p>Note:</p> <p>*1 beyond 75 MHz or more above of the band edge.</p> <p>*2 below the band edge increasing linearly to 10 dBm/MHz at 25 MHz above.</p> <p>*3 below the band edge increasing linearly to a level of 15.6 dBm/MHz at 5 MHz above.</p> <p>*4 from 5 MHz above or below the band edge increasing linearly to a level of 27 dBm/MHz at the band edge.</p>		

## **TEST PROCEDURE**

Below 30 MHz

The setting of the spectrum analyser

RBW	200 Hz (From 9 kHz to 0.15 MHz)/ 9 kHz (From 0.15 MHz to 30 MHz)
VBW	200 Hz (From 9 kHz to 0.15 MHz)/ 9 kHz (From 0.15 MHz to 30 MHz)
Sweep	Auto

1. The testing follows the guidelines in ANSI C63.10-2013 clause 6.4.
2. The EUT was arranged to its worst case and then turntable (from 0 degree to 360 degrees) to find the maximum reading. A pre-amp and a high pass filter are used for the test in order to get better signal level. Both Horizontal, Face-on and Face-off polarizations of the antenna are set to make the measurement.
3. The EUT was placed on a turntable with 80 cm above ground.
4. The EUT was set 3 meters from the interference receiving antenna, which was mounted on the top of a 1 m height antenna tower.
5. The radiated emission limits are based on measurements employing a CISPR quasi-peak detector except for the frequency bands 9-90 kHz, 110-490 kHz and above 1000 MHz Radiated emission limits in these three bands are based on measurements employing an average detector.
6. For measurement below 1 GHz, the initial step in collecting conducted emission data is a spectrum analyzer peak detector mode pre-scanning the measurement frequency range. Significant peaks are then marked and then Quasi Peak and average detector mode re-measured. If the emission level of the EUT measured by the peak detector is 3 dB lower than the applicable limit, the peak emission level will be reported. Otherwise, the emission measurement will be repeated using the quasi-peak and average detector and reported.
7. Although these tests were performed other than open field site, adequate comparison measurements were confirmed against 30m open field site. Therefore sufficient tests were made to demonstrate that the alternative site produces results that correlate with the ones of tests made in an open field site based on KDB 414788.

8. The limits in CFR 47, Part 15, Subpart C, paragraph 15.209 (a), are identical to those in RSS-GEN Section 8.9, Table 6, since the measurements are performed in terms of magnetic field

strength and converted to electric field strength levels (as reported in the table) using the free space impedance of  $377\Omega$ . For example, the measurement frequency X KHz resulted in a level of Y dBuV/m, which is equivalent to  $Y-51.5 = Z$  dBuA/m, which has the same margin, W dB, to the corresponding RSS-GEN Table 6 limit as it has to be 15.209(a) limit.

Below 1 GHz and above 30 MHz

The setting of the spectrum analyser

RBW	120 kHz
VBW	300 kHz
Sweep	Auto
Detector	Peak/QP
Trace	Max hold

1. The testing follows the guidelines in ANSI C63.10-2013 clause 6.5.
2. The EUT was arranged to its worst case and then tune the antenna tower (from 1 m to 4 m) and turntable (from 0 degree to 360 degrees) to find the maximum reading. A pre-amp and a high pass filter are used for the test in order to get better signal level. Both horizontal and vertical polarizations of the antenna are set to make the measurement.
3. The EUT was placed on a turntable with 80 cm above ground.
4. The EUT was set 3 meters from the interference receiving antenna, which was mounted on the top of a variable height antenna tower.
5. For measurement below 1 GHz, the initial step in collecting conducted emission data is a spectrum analyzer peak detector mode pre-scanning the measurement frequency range. Significant peaks are then marked and then Quasi Peak detector mode re-measured. If the emission level of the EUT measured by the peak detector is 3 dB lower than the applicable limit, the peak emission level will be reported. Otherwise, the emission measurement will be repeated using the quasi-peak detector and reported.

Above 1 GHz

The setting of the spectrum analyser

RBW	1 MHz
VBW	PEAK: 3 MHz AVG: see note 6
Sweep	Auto
Detector	Peak
Trace	Max hold

1. The testing follows the guidelines in KDB 789033 D02 General U-NII Test Procedures New Rules v02r01 section II.G.3 ~ II.G.6.
2. The EUT was arranged to its worst case and then tune the antenna tower (from 1 m to 4 m) and turntable (from 0 degree to 360 degrees) to find the maximum reading. A pre-amp and a high pass filter are used for the test in order to get better signal level. Both horizontal and vertical polarizations of the antenna are set to make the measurement.
3. The EUT was placed on a turntable with 1.5 m above ground.
4. The EUT was set 3 meters from the interference receiving antenna, which was mounted on the top of a variable height antenna tower.
5. For measurement above 1 GHz, the emission measurement will be measured by the peak detector. This peak level, once corrected, must comply with the limit specified in Section 15.209.
6. For measurements above 1 GHz the resolution bandwidth is set to 1 MHz, then the video bandwidth is set to 3 MHz for peak measurements and 1 MHz resolution bandwidth with 1/T video bandwidth with peak detector for average measurements. For the Duty Cycle please refer to clause 7.1.ON TIME AND DUTY CYCLE.

X axis, Y axis, Z axis positions:

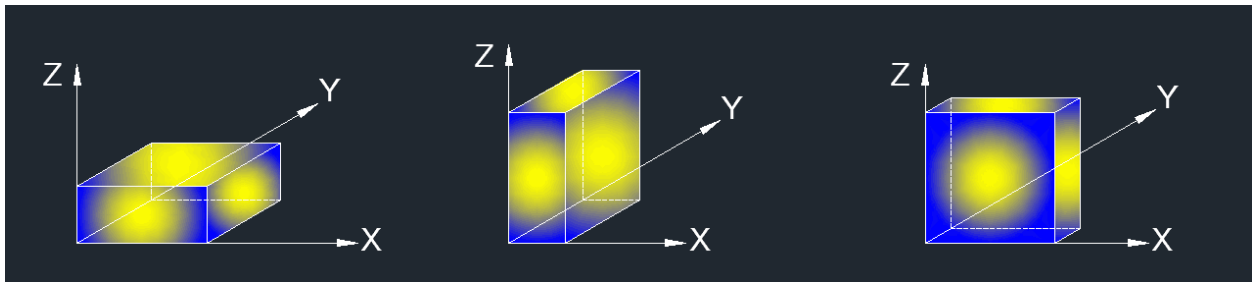

Note 1: For all radiated test, EUT in each of three orthogonal axis emissions had been tested, but only the worst case (X axis) data recorded in the report.

**TEST SETUP**

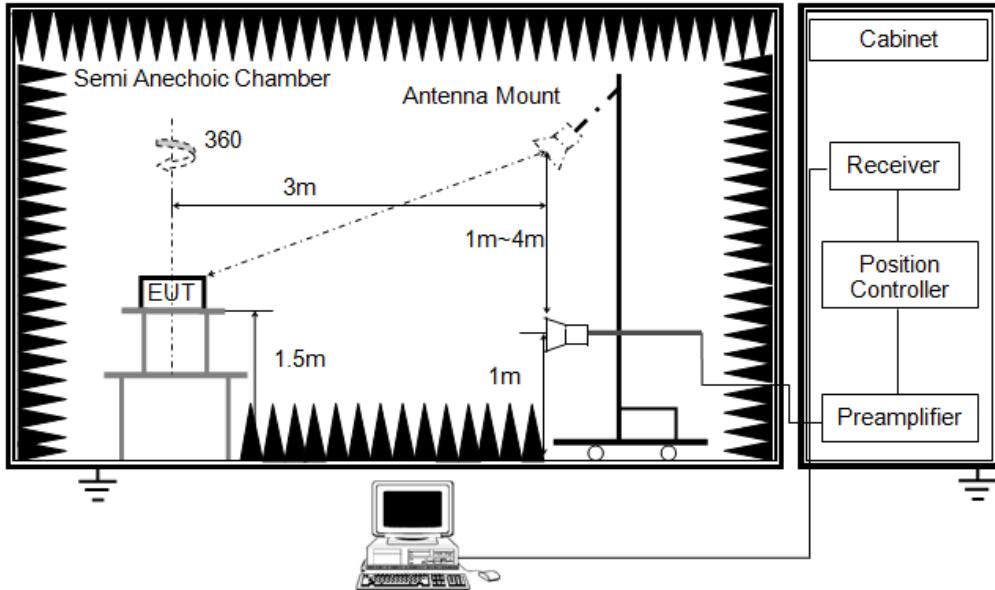
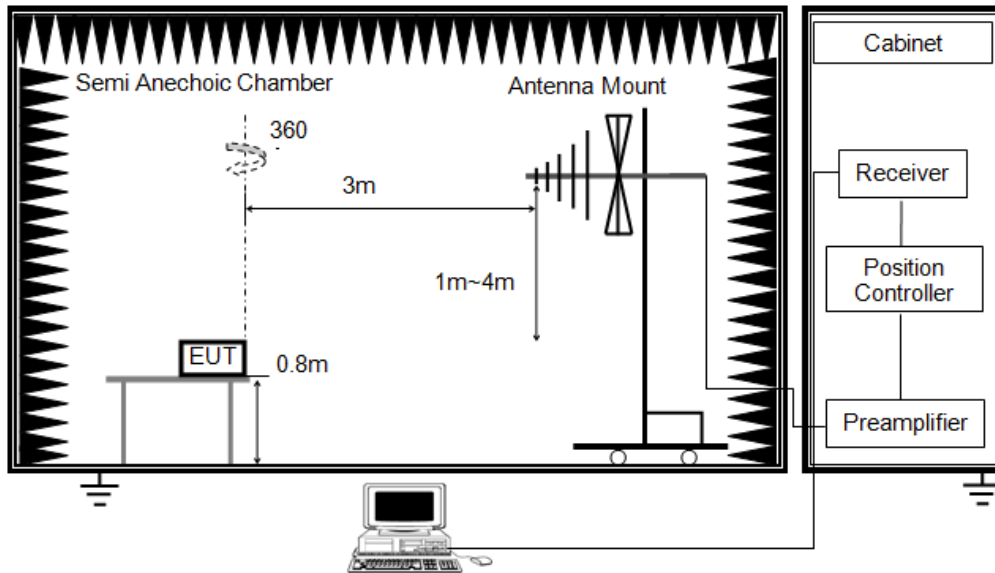
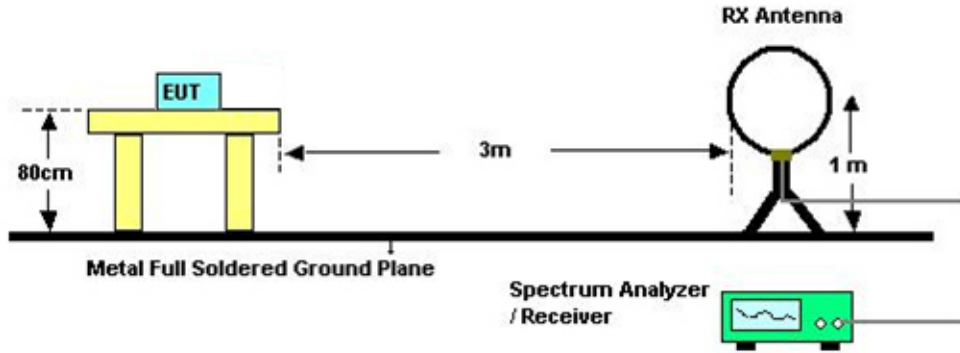

**TEST ENVIRONMENT**

Temperature	24.5°C	Relative Humidity	54%
Atmosphere Pressure	101kPa		

**TEST RESULTS**

Please refer to section 8.1.



### 8.1. RADIATED EMISSIONS AND BAND EDGE MEASUREMENT

Mode:	5G WIFI 802.11ax HE20 5785MHz
Power:	AC 120V/60Hz
TE:	Berny
Date	2023/12/22
T/A/P	24.5°C/54%/101Kpa

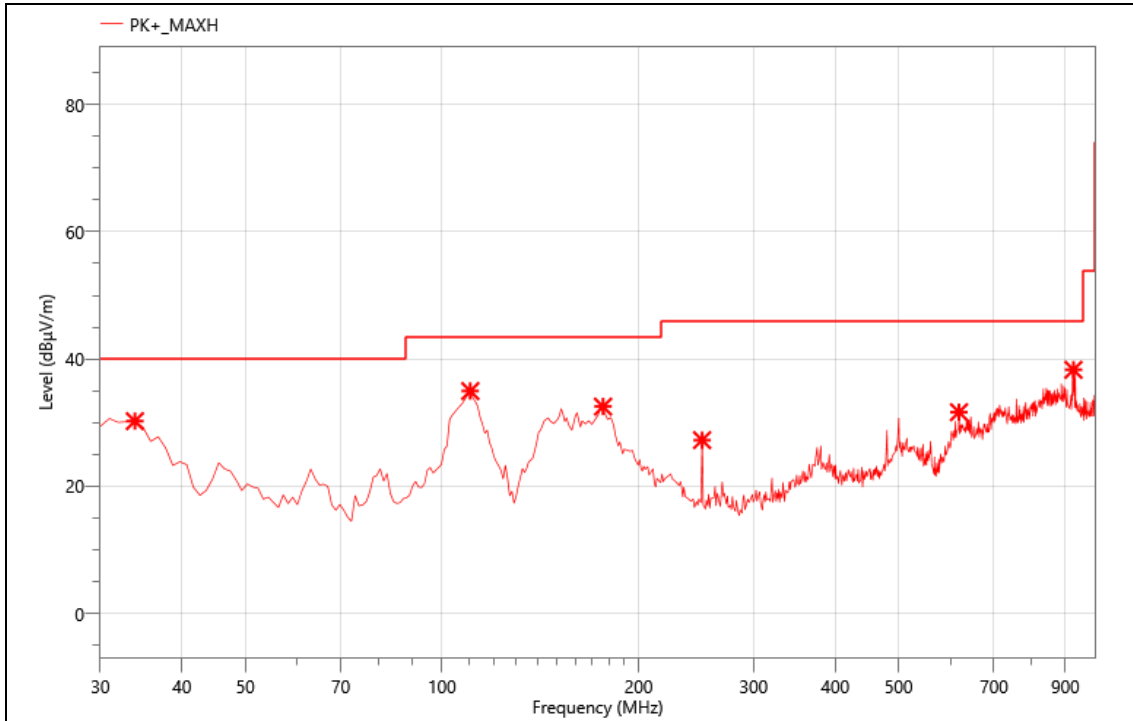

#### Critical\_Freqs

No.	Freq. (MHz)	Reading (dBµV)	Meas. (dBµV/m)	Limit (dBµV/m)	Margin (dBµV/m)	Det.	Pol.	Corr. (dB)
1	33.880	46.73	30.24	40.00	9.76	PK+	V	-16.49
2	110.510	58.95	34.97	43.50	8.53	PK+	V	-23.98
3	176.470	54.75	32.53	43.50	10.97	PK+	V	-22.22
4	250.190	46.33	27.26	46.00	18.74	PK+	V	-19.07
5	618.790	40.88	31.65	46.00	14.35	PK+	V	-9.23
6	926.280	41.49	38.31	46.00	7.69	PK+	V	-3.18

Note: [Margin=Limit-Meas.]; [Meas.=Reading+Corr.]

Mode:	5G WIFI 802.11ax HE20 5785MHz
Power:	AC 120V/60Hz
TE:	Berny
Date	2023/12/22
T/A/P	24.5□/54%/101Kpa



### Critical\_Freqs

No.	Freq. (MHz)	Reading (dBµV)	Meas. (dBµV/m)	Limit (dBµV/m)	Margin (dBµV/m)	Det.	Pol.	Corr. (dB)
1	107.600	47.80	24.15	43.50	24.15	PK+	H	-23.65
2	175.500	49.17	26.90	43.50	26.90	PK+	H	-22.27
3	377.260	46.33	31.31	46.00	31.31	PK+	H	-15.02
4	480.080	43.60	30.59	46.00	30.59	PK+	H	-13.01
5	860.320	41.28	35.77	46.00	35.77	PK+	H	-5.51
6	998.060	42.18	38.49	53.90	38.49	PK+	H	-3.69

Note: [Margin=Limit-Meas.]; [Meas.=Reading+Corr.]

Mode:	5G WIFI 802.11ax HE20 5180MHz
Power:	AC 120V/60Hz
TE:	Berny
Date	2023/12/22
T/A/P	24.3°C/54%/101Kpa

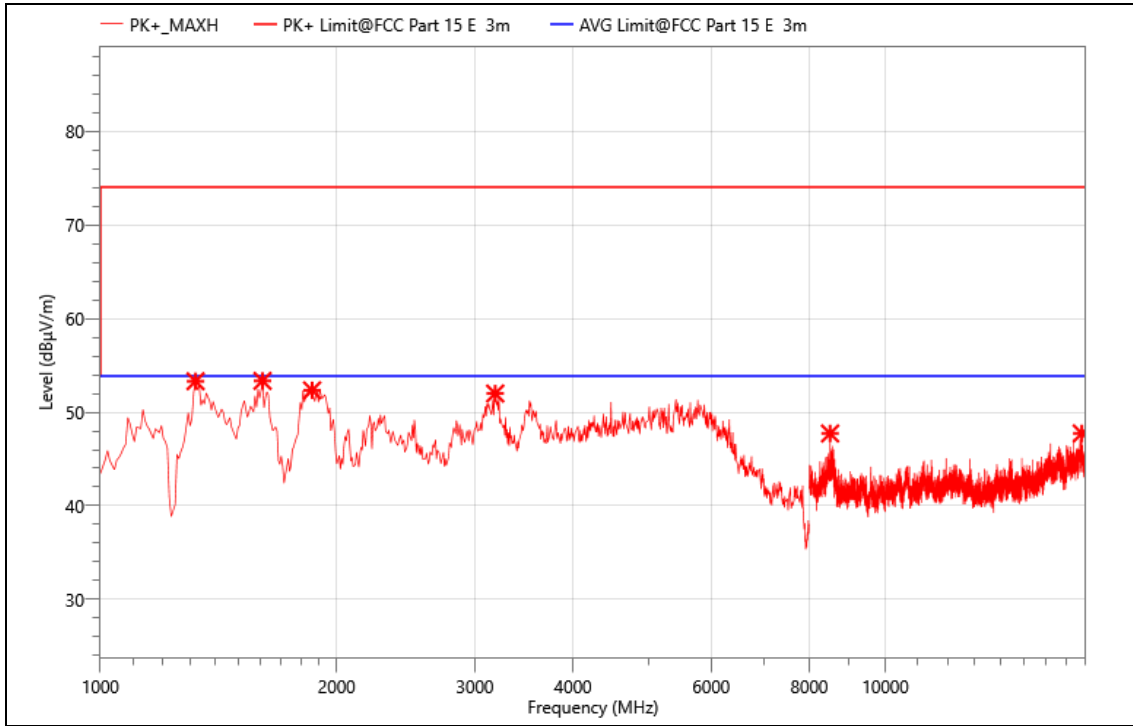

**Critical\_Freqs**

No.	Freq. (MHz)	Reading (dBµV)	Corr. (dB)	Meas. (dBµV/m)	Limit (dBµV/m)	Margin (dB)	Det.	Pol.
1	1322.000	67.44	-14.13	53.31	74.00	20.69	PK+	H
2	1609.000	65.77	-12.42	53.35	74.00	20.65	PK+	H
3	1861.000	62.47	-10.13	52.34	74.00	21.66	PK+	H
4	3184.000	58.22	-6.22	52.00	74.00	22.00	PK+	H
5	8504.000	55.74	-8.01	47.73	74.00	26.27	PK+	H
6	17794.000	47.58	0.16	47.74	74.00	26.26	PK+	H

Note: [Margin=Limit-Meas.]; [Meas.=Reading+Corr.]

Mode:	5G WIFI 802.11ax HE20 5180MHz
Power:	AC 120V/60Hz
TE:	Berny
Date	2023/12/22
T/A/P	24.3□/54%/101Kpa

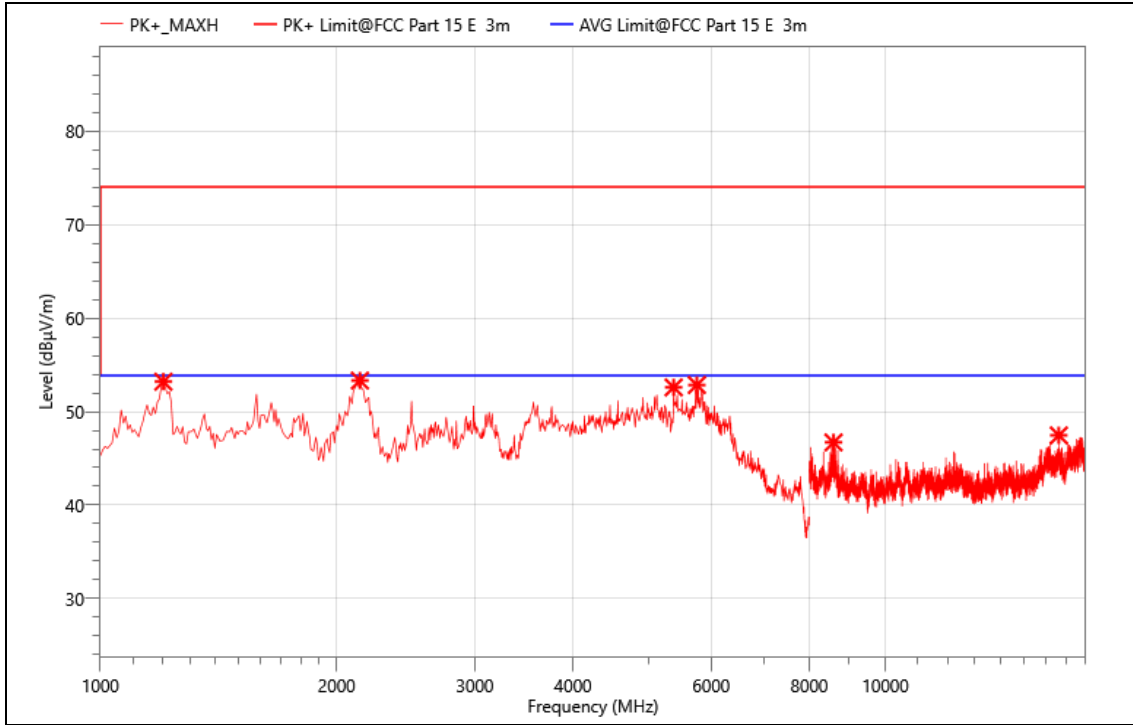

**Critical\_Freqs**

No.	Freq. (MHz)	Reading (dBµV)	Corr. (dB)	Meas. (dBµV/m)	Limit (dBµV/m)	Margin (dB)	Det.	Pol.
1	1203.000	67.36	-14.16	53.20	74.00	20.80	PK+	V
2	2141.000	62.37	-9.04	53.33	74.00	20.67	PK+	V
3	5375.000	52.68	-0.09	52.59	74.00	21.41	PK+	V
4	5753.000	53.15	-0.3	52.85	74.00	21.15	PK+	V
5	8591.000	54.68	-7.97	46.71	74.00	27.29	PK+	V
6	16634.000	48.28	-0.82	47.46	74.00	26.54	PK+	V

Note: [Margin=Limit-Meas.]; [Meas.=Reading+Corr.]

Mode:	5G WIFI 802.11ax HE20 5200MHz
Power:	AC 120V/60Hz
TE:	Berny
Date	2023/12/22
T/A/P	24.3□/54%/101Kpa

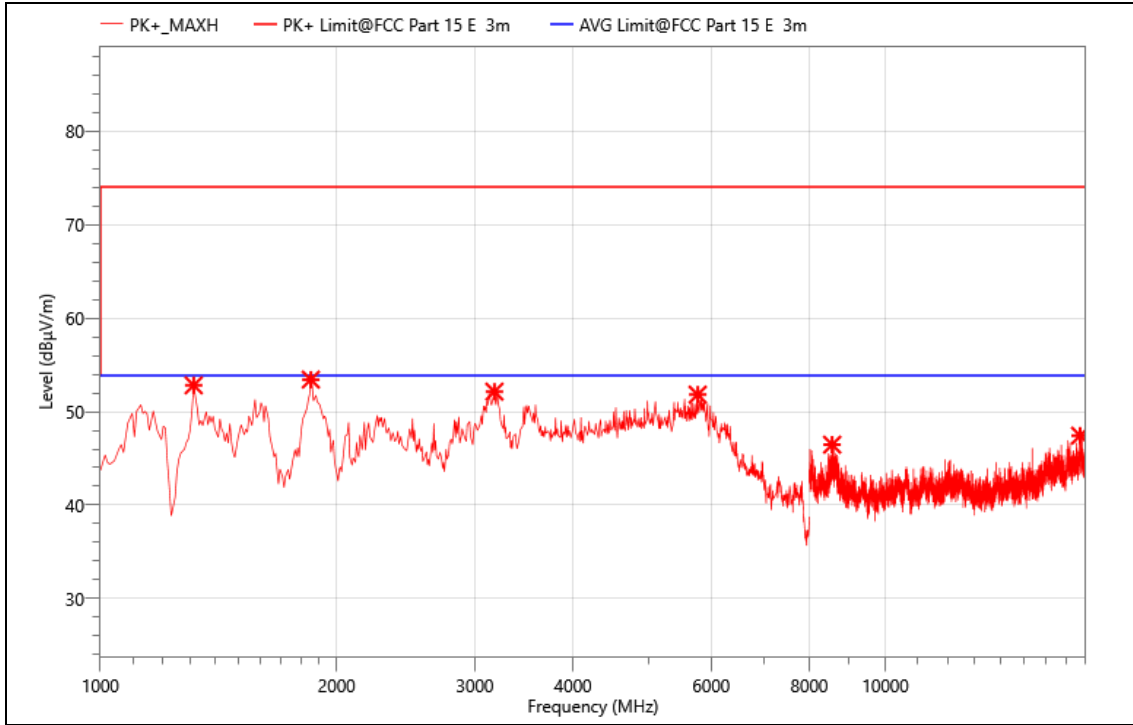

**Critical\_Freqs**

No.	Freq. (MHz)	Reading (dBµV)	Corr. (dB)	Meas. (dBµV/m)	Limit (dBµV/m)	Margin (dB)	Det.	Pol.
1	1315.000	66.90	-14.08	52.82	74.00	21.18	PK+	H
2	1854.000	63.62	-10.19	53.43	74.00	20.57	PK+	H
3	3177.000	58.38	-6.24	52.14	74.00	21.86	PK+	H
4	5767.000	51.87	-0.05	51.82	74.00	22.18	PK+	H
5	8556.000	54.42	-7.95	46.47	74.00	27.53	PK+	H
6	17705.000	47.91	-0.48	47.43	74.00	26.57	PK+	H

Note: [Margin=Limit-Meas.]; [Meas.=Reading+Corr.]

Mode:	5G WIFI 802.11ax HE20 5200MHz
Power:	AC 120V/60Hz
TE:	Berny
Date	2023/12/22
T/A/P	24.3□/54%/101Kpa

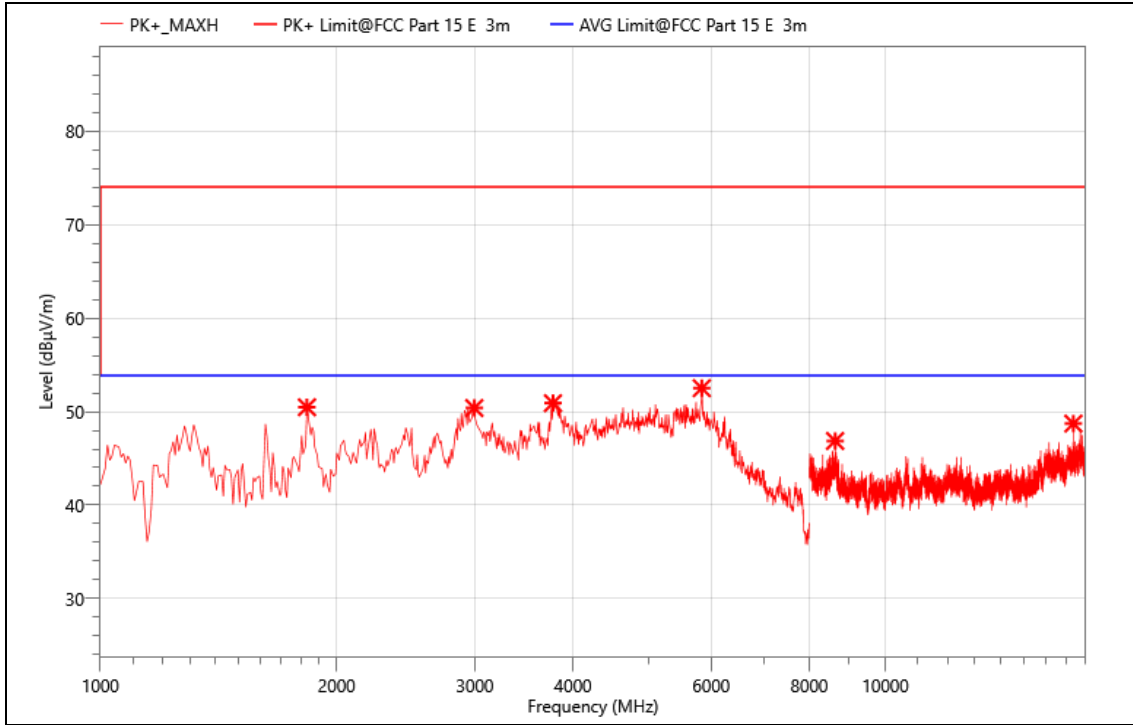

**Critical\_Freqs**

No.	Freq. (MHz)	Reading (dBµV)	Corr. (dB)	Meas. (dBµV/m)	Limit (dBµV/m)	Margin (dB)	Det.	Pol.
1	1833.000	60.94	-10.47	50.47	74.00	23.53	PK+	V
2	2995.000	57.03	-6.64	50.39	74.00	23.61	PK+	V
3	3772.000	54.92	-4.01	50.91	74.00	23.09	PK+	V
4	5837.000	52.61	-0.1	52.51	74.00	21.49	PK+	V
5	8630.000	54.78	-7.92	46.86	74.00	27.14	PK+	V
6	17361.000	49.19	-0.47	48.72	74.00	25.28	PK+	V

Note: [Margin=Limit-Meas.]; [Meas.=Reading+Corr.]

Mode:	5G WIFI 802.11ax HE20 5240MHz
Power:	AC 120V/60Hz
TE:	Berny
Date	2023/12/22
T/A/P	24.3□/54%/101Kpa

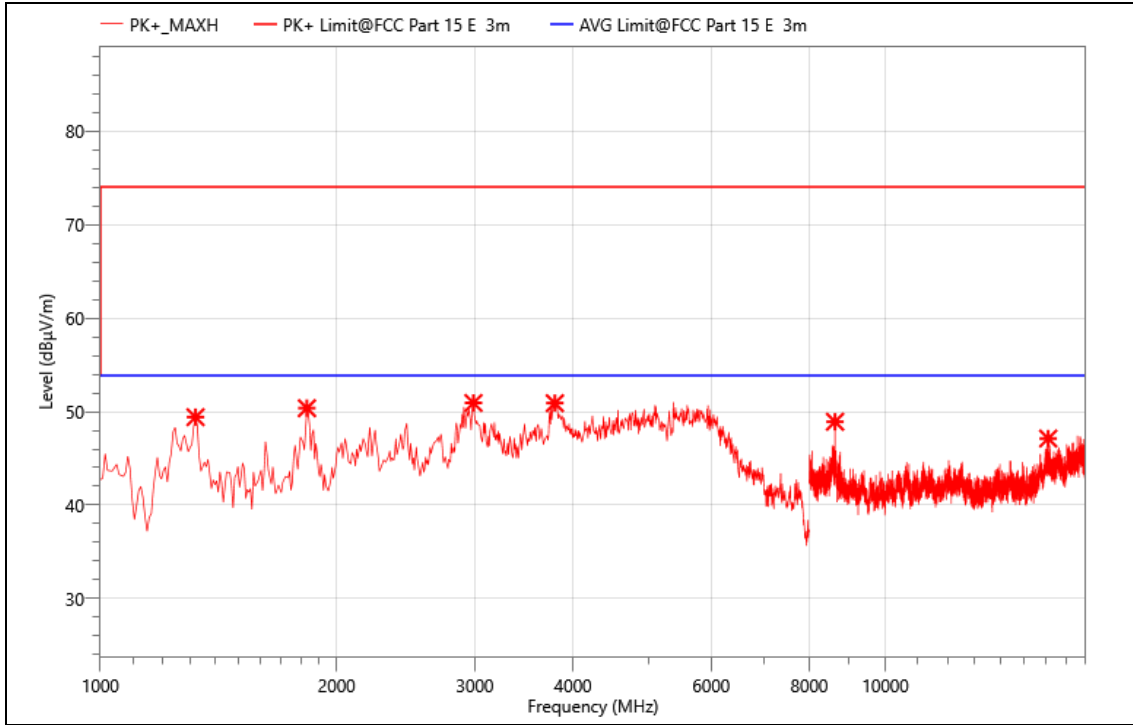

### Critical\_Freqs

No.	Freq. (MHz)	Reading (dBµV)	Corr. (dB)	Meas. (dBµV/m)	Limit (dBµV/m)	Margin (dB)	Det.	Pol.
1	1322.000	63.54	-14.13	49.41	74.00	24.59	PK+	V
2	1833.000	60.84	-10.47	50.37	74.00	23.63	PK+	V
3	2988.000	57.69	-6.76	50.93	74.00	23.07	PK+	V
4	3793.000	54.73	-3.82	50.91	74.00	23.09	PK+	V
5	8627.000	56.84	-7.92	48.92	74.00	25.08	PK+	V
6	16124.000	48.00	-0.88	47.12	74.00	26.88	PK+	V

Note: [Margin=Limit-Meas.]; [Meas.=Reading+Corr.]

Mode:	5G WIFI 802.11ax HE20 5240MHz
Power:	AC 120V/60Hz
TE:	Berny
Date	2023/12/22
T/A/P	24.3□/54%/101Kpa

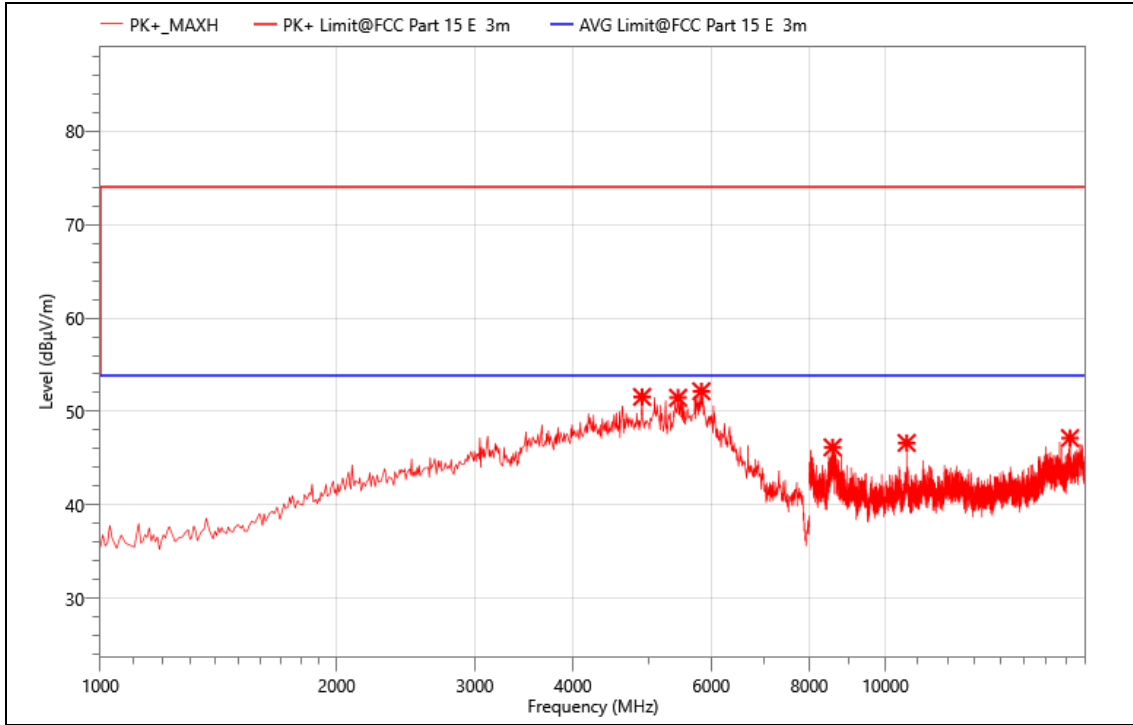

### Critical\_Freqs

No.	Freq. (MHz)	Reading (dBµV)	Corr. (dB)	Meas. (dBµV/m)	Limit (dBµV/m)	Margin (dB)	Det.	Pol.
1	4899.000	53.42	-1.86	51.56	74.00	22.44	PK+	H
2	5445.000	51.74	-0.27	51.47	74.00	22.53	PK+	H
3	5830.000	52.26	-0.1	52.16	74.00	21.84	PK+	H
4	8568.000	54.08	-7.92	46.16	74.00	27.84	PK+	H
5	10646.000	50.99	-4.36	46.63	74.00	27.37	PK+	H
6	17190.000	48.28	-1.13	47.15	74.00	26.85	PK+	H

Note: [Margin=Limit-Meas.]; [Meas.=Reading+Corr.]



Mode:	5G WIFI 802.11ax HE20 5260MHz
Power:	AC 120V/60Hz
TE:	Berny
Date	2023/12/22
T/A/P	24.3□/54%/101Kpa

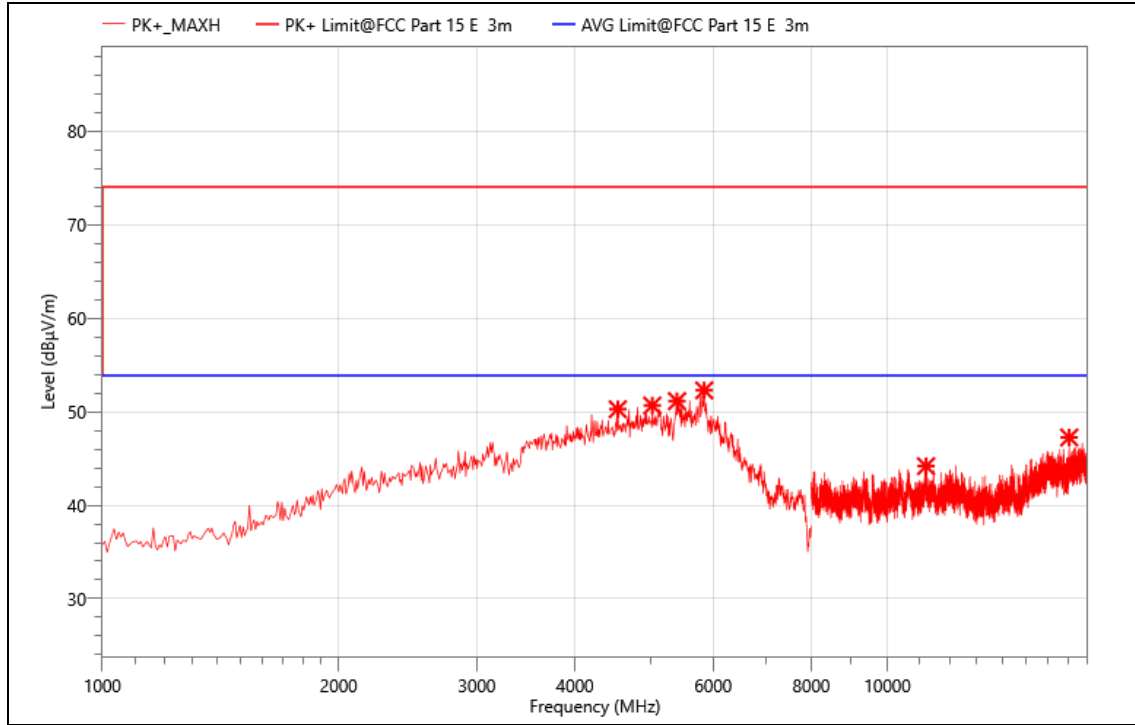

**Critical\_Freqs**

No.	Freq. (MHz)	Reading (dBµV)	Corr. (dB)	Meas. (dBµV/m)	Limit (dBµV/m)	Margin (dB)	Det.	Pol.
1	4535.000	53.25	-2.98	50.27	74.00	23.73	PK+	H
2	5018.000	52.46	-1.79	50.67	74.00	23.33	PK+	H
3	5396.000	51.20	-0.06	51.14	74.00	22.86	PK+	H
4	5844.000	52.42	-0.13	52.29	74.00	21.71	PK+	H
5	11202.000	48.67	-4.49	44.18	74.00	29.82	PK+	H
6	17049.000	48.12	-0.87	47.25	74.00	26.75	PK+	H

Note: [Margin=Limit-Meas.]; [Meas.=Reading+Corr.]

Mode:	5G WIFI 802.11ax HE20 5260MHz
Power:	AC 120V/60Hz
TE:	Berny
Date	2023/12/22
T/A/P	24.3□/54%/101Kpa

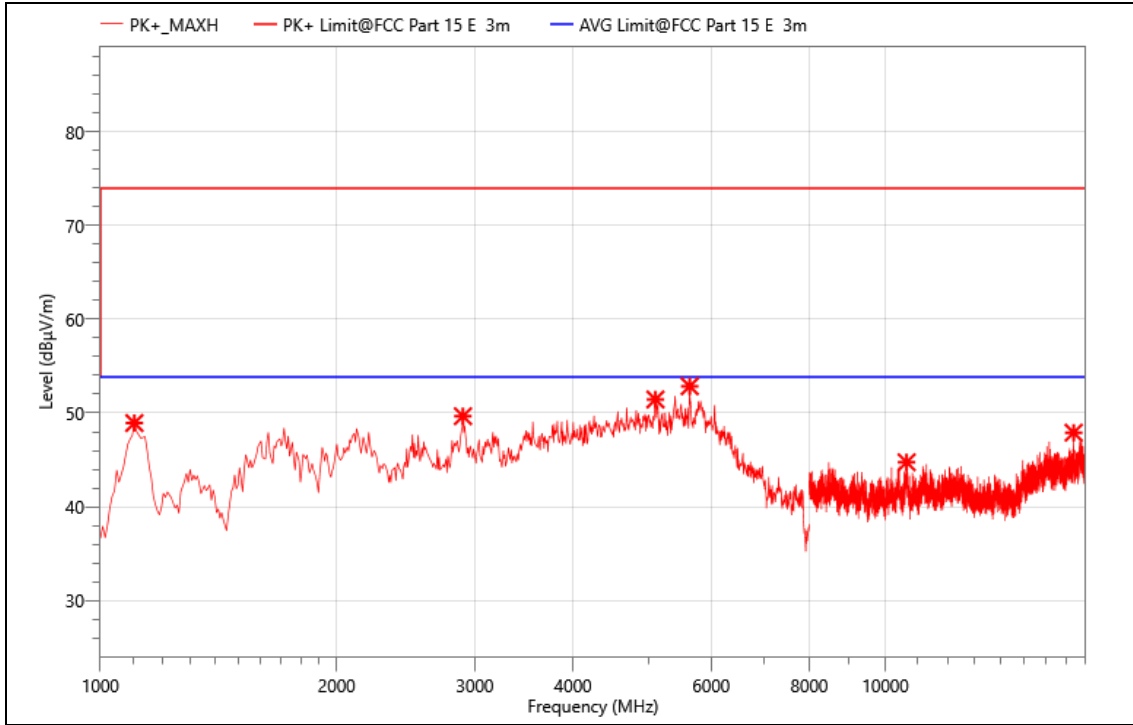

**Critical\_Freqs**

No.	Freq. (MHz)	Reading (dBµV)	Corr. (dB)	Meas. (dBµV/m)	Limit (dBµV/m)	Margin (dB)	Det.	Pol.
1	1105.000	63.83	-14.9	48.93	74.00	25.07	PK+	V
2	2897.000	56.93	-7.27	49.66	74.00	24.34	PK+	V
3	5095.000	52.24	-0.8	51.44	74.00	22.56	PK+	V
4	5634.000	53.65	-0.8	52.85	74.00	21.15	PK+	V
5	10643.000	49.08	-4.33	44.75	74.00	29.25	PK+	V
6	17375.000	48.20	-0.3	47.90	74.00	26.10	PK+	V

Note: [Margin=Limit-Meas.]; [Meas.=Reading+Corr.]

Mode:	5G WIFI 802.11ax HE20 5280MHz
Power:	AC 120V/60Hz
TE:	Berny
Date	2023/12/22
T/A/P	24.3□/54%/101Kpa

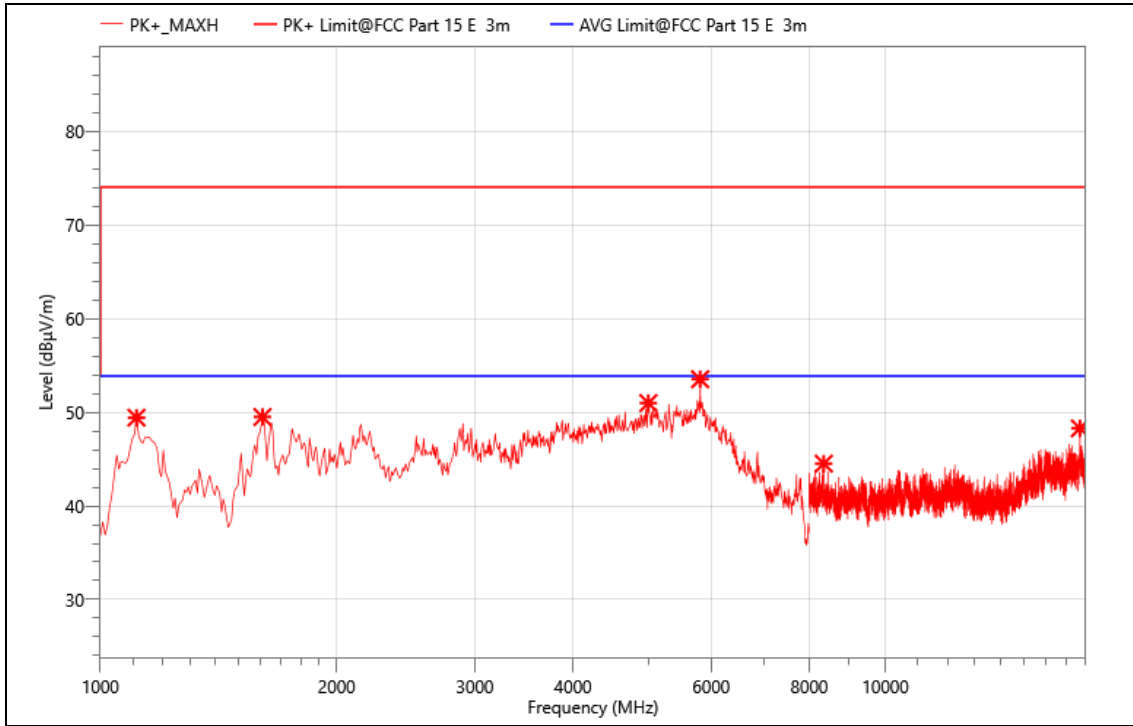

**Critical\_Freqs**

No.	Freq. (MHz)	Reading (dBµV)	Corr. (dB)	Meas. (dBµV/m)	Limit (dBµV/m)	Margin (dB)	Det.	Pol.
1	1112.000	64.30	-14.87	49.43	74.00	24.57	PK+	V
2	1609.000	61.92	-12.42	49.50	74.00	24.50	PK+	V
3	4990.000	52.63	-1.64	50.99	74.00	23.01	PK+	V
4	5809.000	53.80	-0.26	53.54	74.00	20.46	PK+	V
5	8347.000	52.20	-7.68	44.52	74.00	29.48	PK+	V
6	17694.000	48.70	-0.41	48.29	74.00	25.71	PK+	V

Note: [Margin=Limit-Meas.]; [Meas.=Reading+Corr.]

Mode:	5G WIFI 802.11ax HE20 5280MHz
Power:	AC 120V/60Hz
TE:	Berny
Date	2023/12/22
T/A/P	24.3□/54%/101Kpa

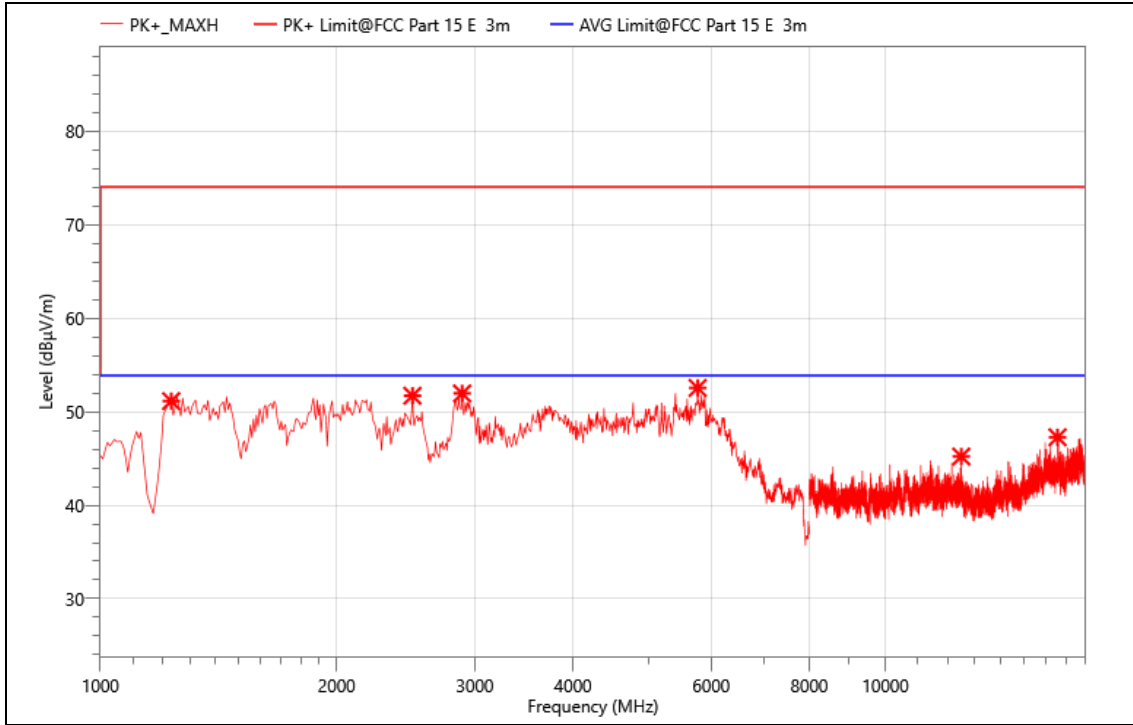

**Critical\_Freqs**

No.	Freq. (MHz)	Reading (dBµV)	Corr. (dB)	Meas. (dBµV/m)	Limit (dBµV/m)	Margin (dB)	Det.	Pol.
1	1231.000	65.39	-14.25	51.14	74.00	22.86	PK+	H
2	2498.000	59.84	-8.12	51.72	74.00	22.28	PK+	H
3	2890.000	59.24	-7.28	51.96	74.00	22.04	PK+	H
4	5767.000	52.60	-0.05	52.55	74.00	21.45	PK+	H
5	12495.000	49.23	-4.02	45.21	74.00	28.79	PK+	H
6	16571.000	48.62	-1.35	47.27	74.00	26.73	PK+	H

Note: [Margin=Limit-Meas.]; [Meas.=Reading+Corr.]

Mode:	5G WIFI 802.11ax HE20 5320MHz
Power:	AC 120V/60Hz
TE:	Berny
Date	2023/12/22
T/A/P	24.3□/54%/101Kpa

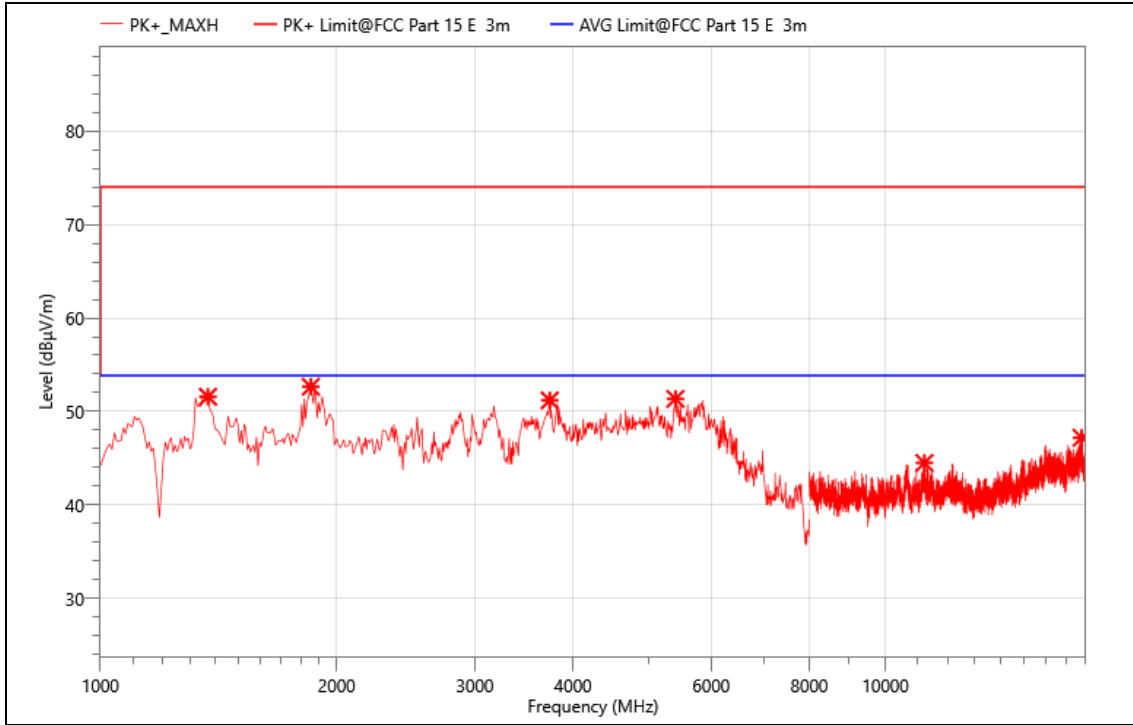

**Critical\_Freqs**

No.	Freq. (MHz)	Reading (dBµV)	Corr. (dB)	Meas. (dBµV/m)	Limit (dBµV/m)	Margin (dB)	Det.	Pol.
1	1371.000	65.24	-13.67	51.57	74.00	22.43	PK+	H
2	1854.000	62.83	-10.19	52.64	74.00	21.36	PK+	H
3	3737.000	54.90	-3.72	51.18	74.00	22.82	PK+	H
4	5403.000	51.40	-0.06	51.34	74.00	22.66	PK+	H
5	11215.000	48.72	-4.23	44.49	74.00	29.51	PK+	H
6	17784.000	47.22	-0.04	47.18	74.00	26.82	PK+	H

Note: [Margin=Limit-Meas.]; [Meas.=Reading+Corr.]

Mode:	5G WIFI 802.11ax HE20 5320MHz
Power:	AC 120V/60Hz
TE:	Berny
Date	2023/12/22
T/A/P	24.3□/54%/101Kpa

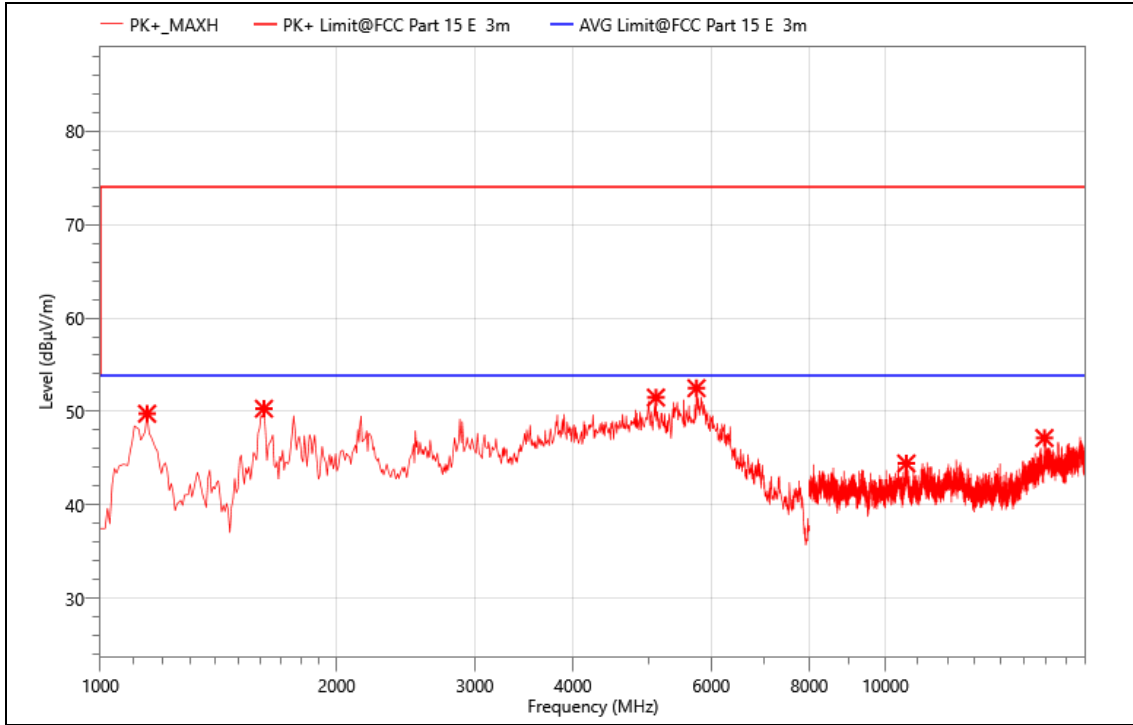

**Critical\_Freqs**

No.	Freq. (MHz)	Reading (dBµV)	Corr. (dB)	Meas. (dBµV/m)	Limit (dBµV/m)	Margin (dB)	Det.	Pol.
1	1147.000	64.48	-14.73	49.75	74.00	24.25	PK+	V
2	1616.000	62.68	-12.39	50.29	74.00	23.71	PK+	V
3	5102.000	52.13	-0.64	51.49	74.00	22.51	PK+	V
4	5746.000	52.91	-0.42	52.49	74.00	21.51	PK+	V
5	10636.000	48.79	-4.36	44.43	74.00	29.57	PK+	V
6	15946.000	48.70	-1.55	47.15	74.00	26.85	PK+	V

Note: [Margin=Limit-Meas.]; [Meas.=Reading+Corr.]

Mode:	5G WIFI 802.11ax HE20 5745MHz
Power:	AC 120V/60Hz
TE:	Berny
Date	2023/12/22
T/A/P	24.3□/54%/101Kpa

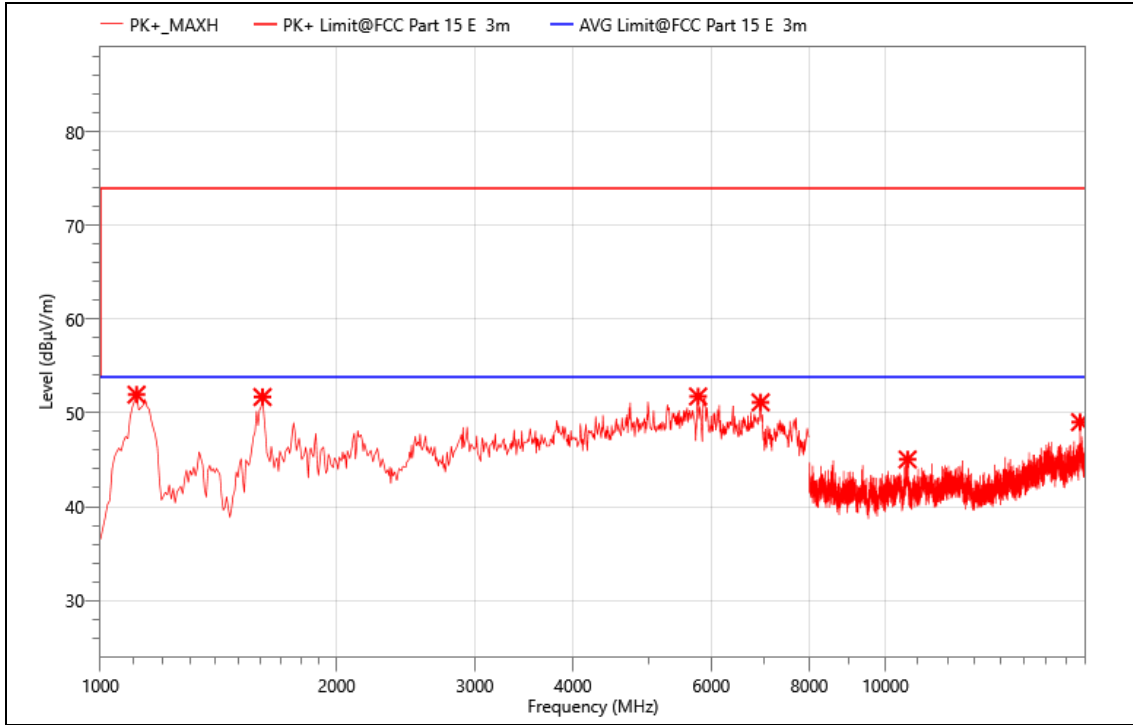

**Critical\_Freqs**

No.	Freq. (MHz)	Reading (dBµV)	Corr. (dB)	Meas. (dBµV/m)	Limit (dBµV/m)	Margin (dB)	Det.	Pol.
1	1112.000	67.31	-15.36	51.95	74.00	22.05	PK+	V
2	1609.000	64.63	-12.94	51.69	74.00	22.31	PK+	V
3	5774.000	52.97	-1.22	51.75	74.00	22.25	PK+	V
4	6936.000	43.60	7.52	51.12	74.00	22.88	PK+	V
5	10674.000	49.47	-4.43	45.04	74.00	28.96	PK+	V
6	17704.000	49.48	-0.47	49.01	74.00	24.99	PK+	V

Note: [Margin=Limit-Meas.]; [Meas.=Reading+Corr.]

Mode:	5G WIFI 802.11ax HE20 5745MHz
Power:	AC 120V/60Hz
TE:	Berny
Date	2023/12/22
T/A/P	24.3□/54%/101Kpa

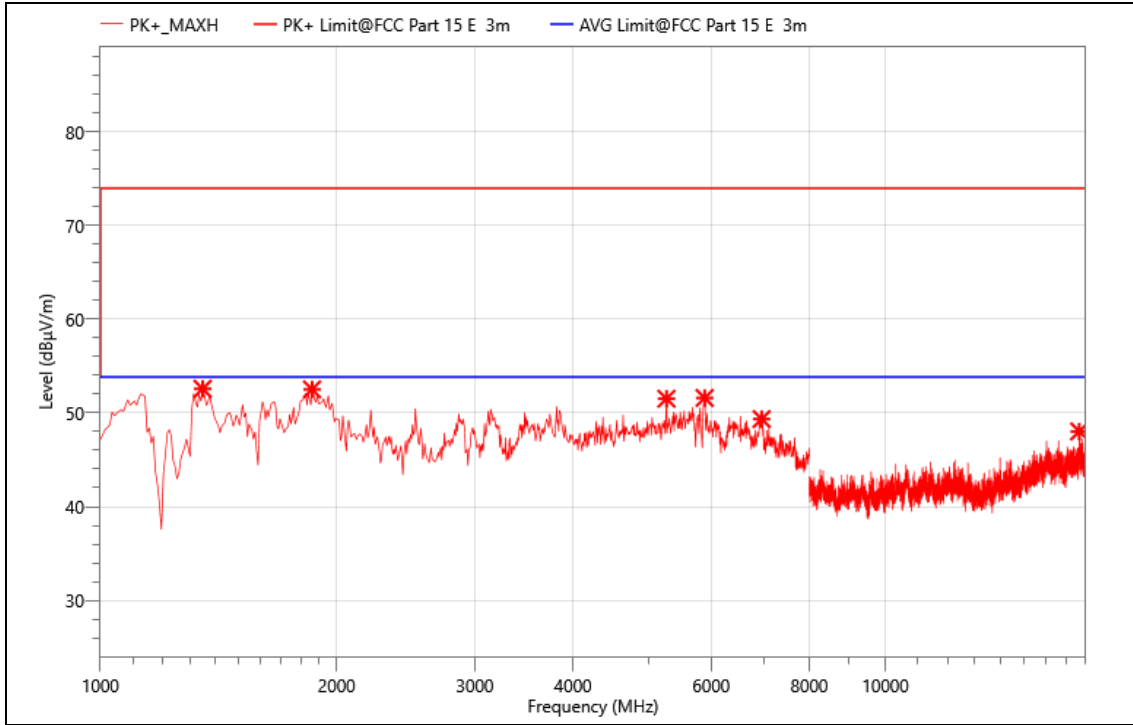

### Critical\_Freqs

No.	Freq. (MHz)	Reading (dBµV)	Corr. (dB)	Meas. (dBµV/m)	Limit (dBµV/m)	Margin (dB)	Det.	Pol.
1	1350.000	66.65	-14.08	52.57	74.00	21.43	PK+	H
2	1861.000	63.02	-10.51	52.51	74.00	21.49	PK+	H
3	5263.000	53.68	-2.17	51.51	74.00	22.49	PK+	H
4	5886.000	52.29	-0.7	51.59	74.00	22.41	PK+	H
5	6957.000	41.70	7.64	49.34	74.00	24.66	PK+	H
6	17662.000	48.42	-0.4	48.02	74.00	25.98	PK+	H

Note: [Margin=Limit-Meas.]; [Meas.=Reading+Corr.]



Mode:	5G WIFI 802.11ax HE20 5785MHz
Power:	AC 120V/60Hz
TE:	Berny
Date	2023/12/22
T/A/P	24.3□/54%/101Kpa

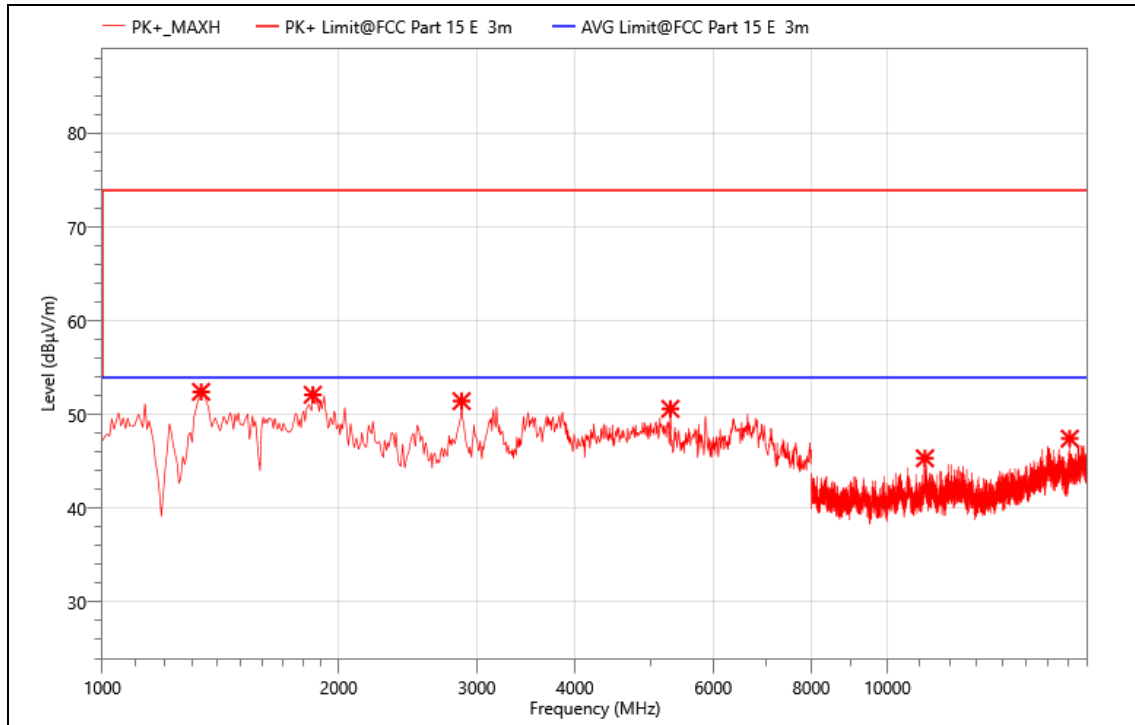

**Critical\_Freqs**

No.	Freq. (MHz)	Reading (dBµV)	Corr. (dB)	Meas. (dBµV/m)	Limit (dBµV/m)	Margin (dB)	Det.	Pol.
1	1336.000	66.79	-14.37	52.42	74.00	21.58	PK+	H
2	1854.000	62.67	-10.56	52.11	74.00	21.89	PK+	H
3	2869.000	59.82	-8.39	51.43	74.00	22.57	PK+	H
4	5291.000	51.80	-1.19	50.61	74.00	23.39	PK+	H
5	11166.000	49.71	-4.38	45.33	74.00	28.67	PK+	H
6	17076.000	48.09	-0.66	47.43	74.00	26.57	PK+	H

Note: [Margin=Limit-Meas.]; [Meas.=Reading+Corr.]

Mode:	5G WIFI 802.11ax HE20 5785MHz
Power:	AC 120V/60Hz
TE:	Berny
Date	2023/12/22
T/A/P	24.3□/54%/101Kpa

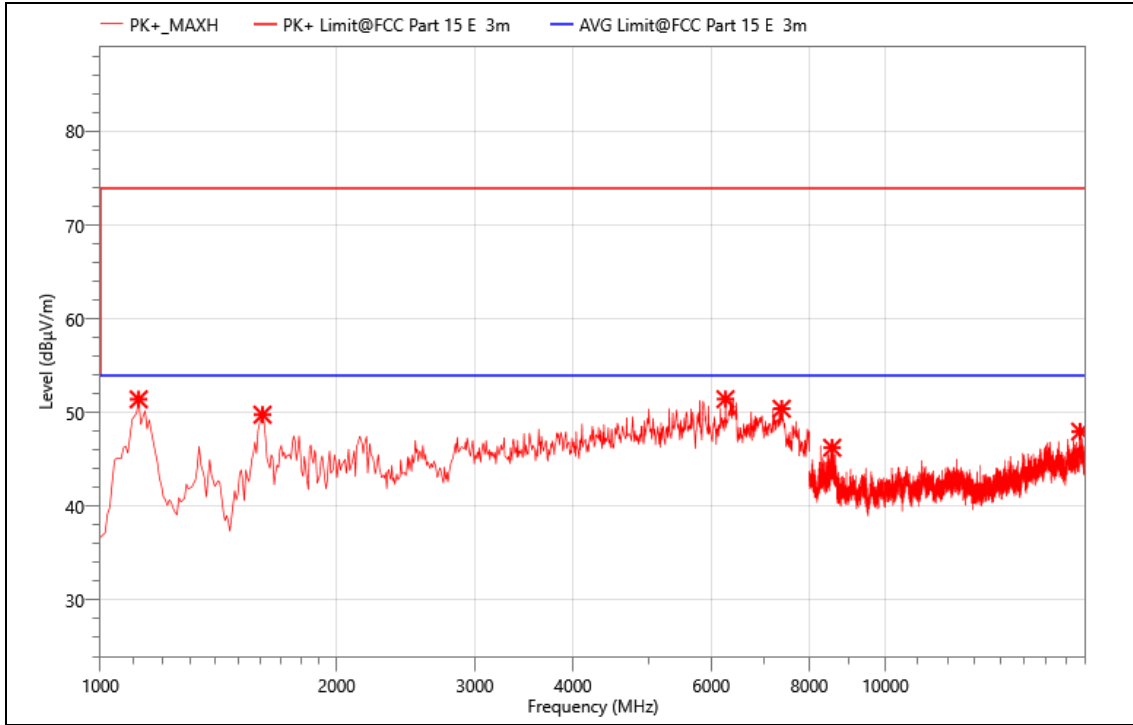

**Critical\_Freqs**

No.	Freq. (MHz)	Reading (dBµV)	Corr. (dB)	Meas. (dBµV/m)	Limit (dBµV/m)	Margin (dB)	Det.	Pol.
1	1119.000	66.74	-15.33	51.41	74.00	22.59	PK+	V
2	1609.000	62.71	-12.94	49.77	74.00	24.23	PK+	V
3	6257.000	50.06	1.37	51.43	74.00	22.57	PK+	V
4	7377.000	40.53	9.88	50.41	74.00	23.59	PK+	V
5	8556.000	54.19	-7.95	46.24	74.00	27.76	PK+	V
6	17709.000	48.49	-0.52	47.97	74.00	26.03	PK+	V

Note: [Margin=Limit-Meas.]; [Meas.=Reading+Corr.]

Mode:	5G WIFI 802.11ax HE20 5825MHz
Power:	AC 120V/60Hz
TE:	Berny
Date	2023/12/22
T/A/P	24.3□/54%/101Kpa

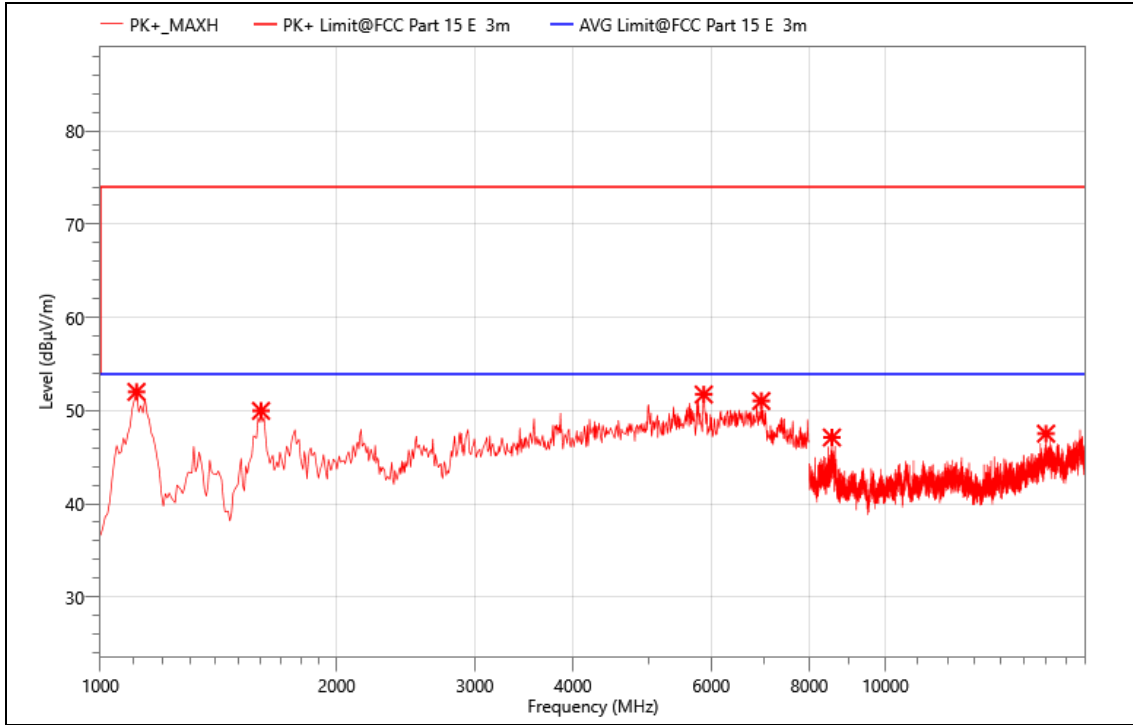

### Critical\_Freqs

No.	Freq. (MHz)	Reading (dBµV)	Corr. (dB)	Meas. (dBµV/m)	Limit (dBµV/m)	Margin (dB)	Det.	Pol.
1	1112.000	67.37	-15.36	52.01	74.00	21.99	PK+	V
2	1602.000	62.95	-12.98	49.97	74.00	24.03	PK+	V
3	5872.000	51.68	0.05	51.73	74.00	22.27	PK+	V
4	6950.000	43.35	7.68	51.03	74.00	22.97	PK+	V
5	8550.000	55.10	-7.99	47.11	74.00	26.89	PK+	V
6	16020.000	49.20	-1.68	47.52	74.00	26.48	PK+	V

Note: [Margin=Limit-Meas.]; [Meas.=Reading+Corr.]

Mode:	5G WIFI 802.11ax HE20 5825MHz
Power:	AC 120V/60Hz
TE:	Berny
Date	2023/12/22
T/A/P	24.3□/54%/101Kpa

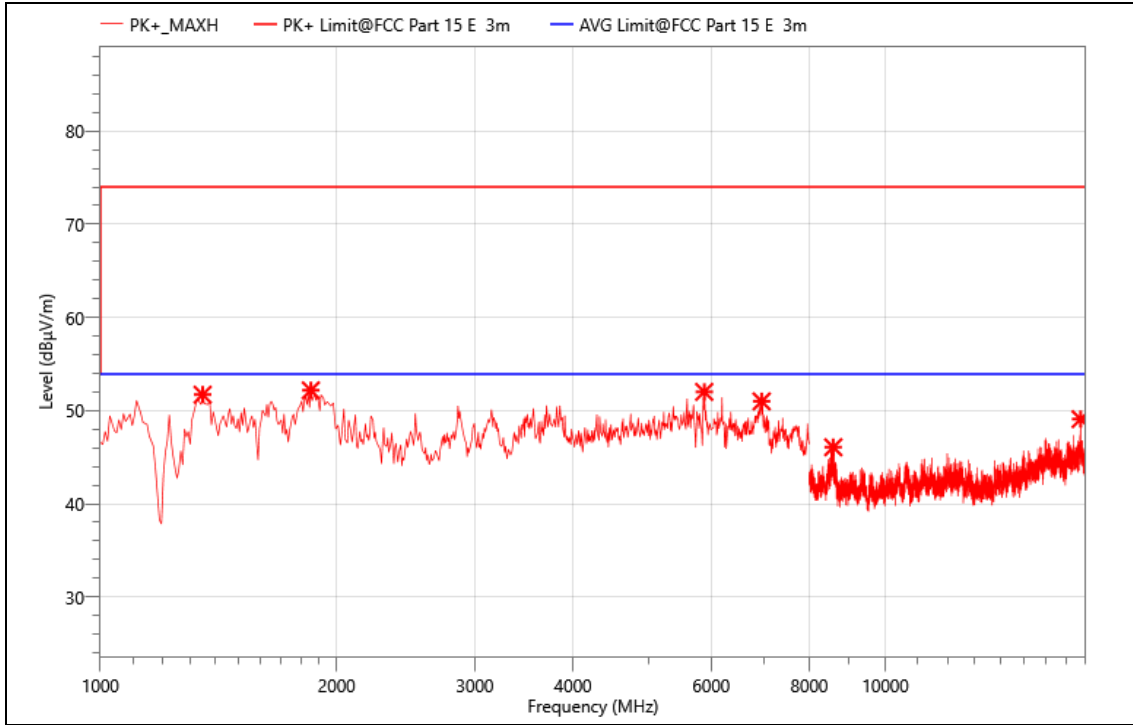

**Critical\_Freqs**

No.	Freq. (MHz)	Reading (dBµV)	Corr. (dB)	Meas. (dBµV/m)	Limit (dBµV/m)	Margin (dB)	Det.	Pol.
1	1350.000	65.79	-14.08	51.71	74.00	22.29	PK+	H
2	1854.000	62.74	-10.56	52.18	74.00	21.82	PK+	H
3	5879.000	52.34	-0.33	52.01	74.00	21.99	PK+	H
4	6957.000	43.35	7.64	50.99	74.00	23.01	PK+	H
5	8583.000	54.03	-7.96	46.07	74.00	27.93	PK+	H
6	17732.000	49.77	-0.69	49.08	74.00	24.92	PK+	H

Note:

1. Measurement = Reading Level + Correct Factor.
2. If Peak Result complies with AV limit, AV Result is deemed to comply with AV limit.
3. Peak: Peak detector.
4. Only the worst data was recorded, if it complies with the limit, the other emissions deemed to comply with the limit.
5. The frequency, which started from 18 GHz to 40GHz, was pre-scanned and the result which was 20dB lower than the limit line was not reported.
6. 802.11a,802.11n HT20,802.11n HT40,802.11ac VHT20,802.11ac VHT40,802.11ac VHT80,802.11ac VHT160,802.11ax HE20,802.11ax HE40,802.11ax HE80 and 802.11ax HE160 were all tested, and only 802.11ax HE20 was recorded in the report as the worst mode.

Mode:	5G WIFI 802.11ax HE20 5180MHz
Power:	AC 120V/60Hz
TE:	Berny
Date	2023/12/22
T/A/P	24.3°C/54%/101Kpa

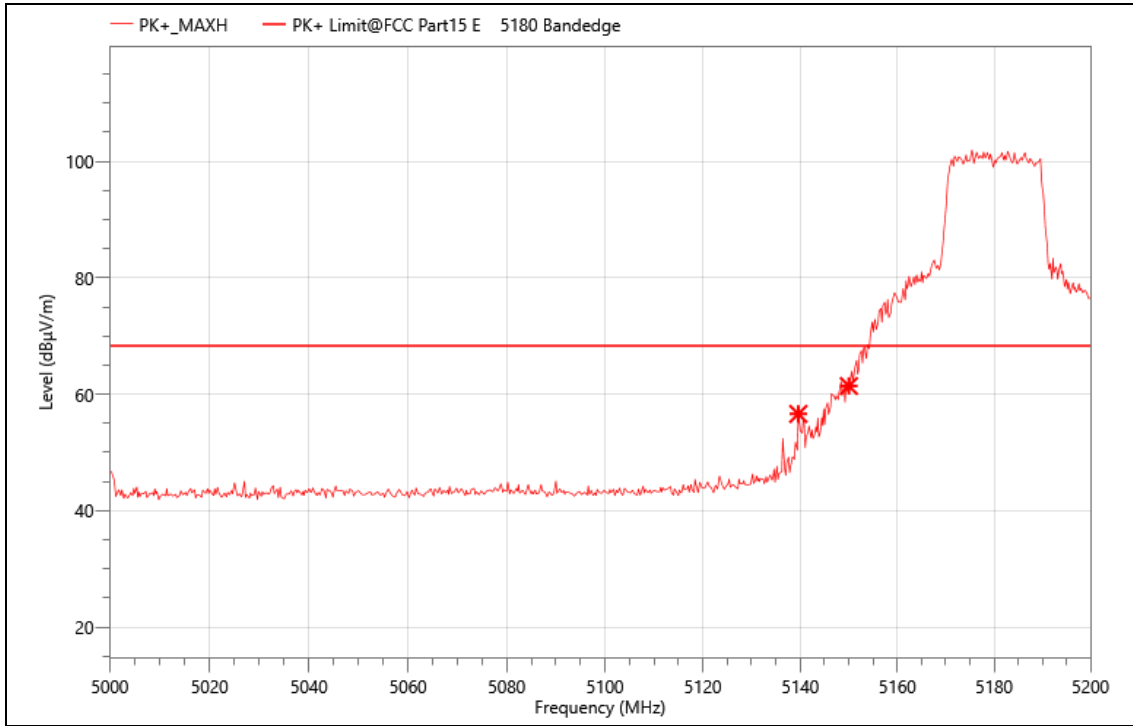

**Critical\_Freqs**

No.	Freq. (MHz)	Reading (dBµV)	Corr. (dB)	Meas. (dBµV/m)	Limit (dBµV/m)	Margin (dB)	Det.	Pol.
1	5139.600	67.59	-10.97	56.62	68.20	11.58	PK+	V
2	5150.000	72.26	-10.84	61.42	68.20	6.78	PK+	V

Note: [Margin=Limit-Meas.]; [Meas.=Reading+Corr.]

Mode:	5G WIFI 802.11ax HE20 5180MHz
Power:	AC 120V/60Hz
TE:	Berny
Date	2023/12/22
T/A/P	24.3□/54%/101Kpa

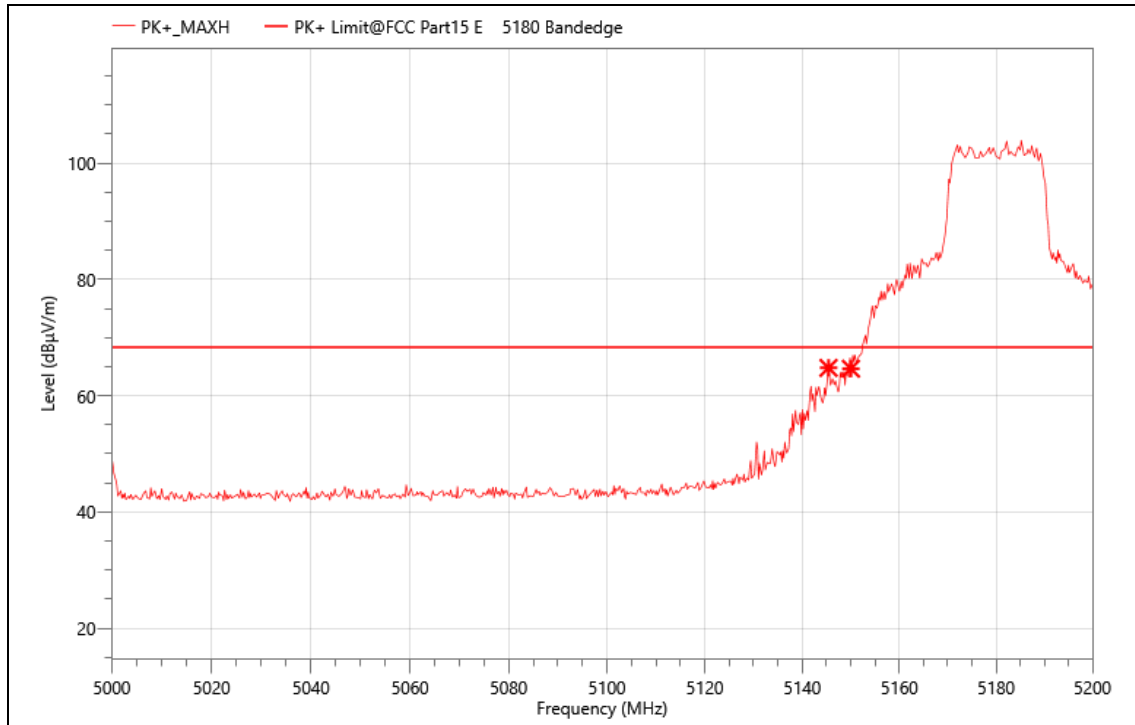

**Critical\_Freqs**

No.	Freq. (MHz)	Reading (dBµV)	Corr. (dB)	Meas. (dBµV/m)	Limit (dBµV/m)	Margin (dB)	Det.	Pol.
1	5145.400	75.68	-10.89	64.79	68.20	3.41	PK+	H
2	5150.000	75.49	-10.84	64.65	68.20	3.55	PK+	H

Note: [Margin=Limit-Meas.]; [Meas.=Reading+Corr.]

Mode:	5G WIFI 802.11ax HE20 5240MHz
Power:	AC 120V/60Hz
TE:	Berny
Date	2023/12/22
T/A/P	24.3□/54%/101Kpa

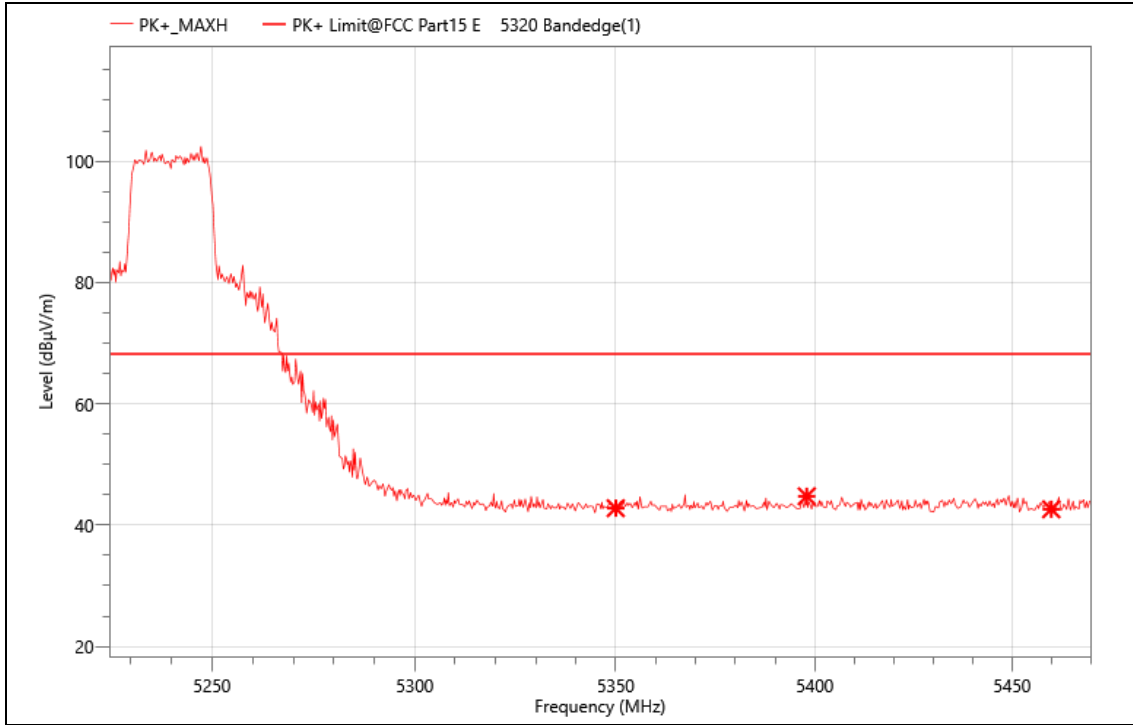

### Critical\_Freqs

No.	Freq. (MHz)	Reading (dBµV)	Corr. (dB)	Meas. (dBµV/m)	Limit (dBµV/m)	Margin (dB)	Det.	Pol.
1	5350.000	52.82	-10.03	42.79	68.20	25.41	PK+	V
2	5397.970	54.54	-9.78	44.76	68.20	23.44	PK+	V
3	5460.000	52.87	-10.26	42.61	68.20	25.59	PK+	V

Note: [Margin=Limit-Meas.]; [Meas.=Reading+Corr.]

Mode:	5G WIFI 802.11ax HE20 5240MHz
Power:	AC 120V/60Hz
TE:	Berny
Date	2023/12/22
T/A/P	24.3□/54%/101Kpa

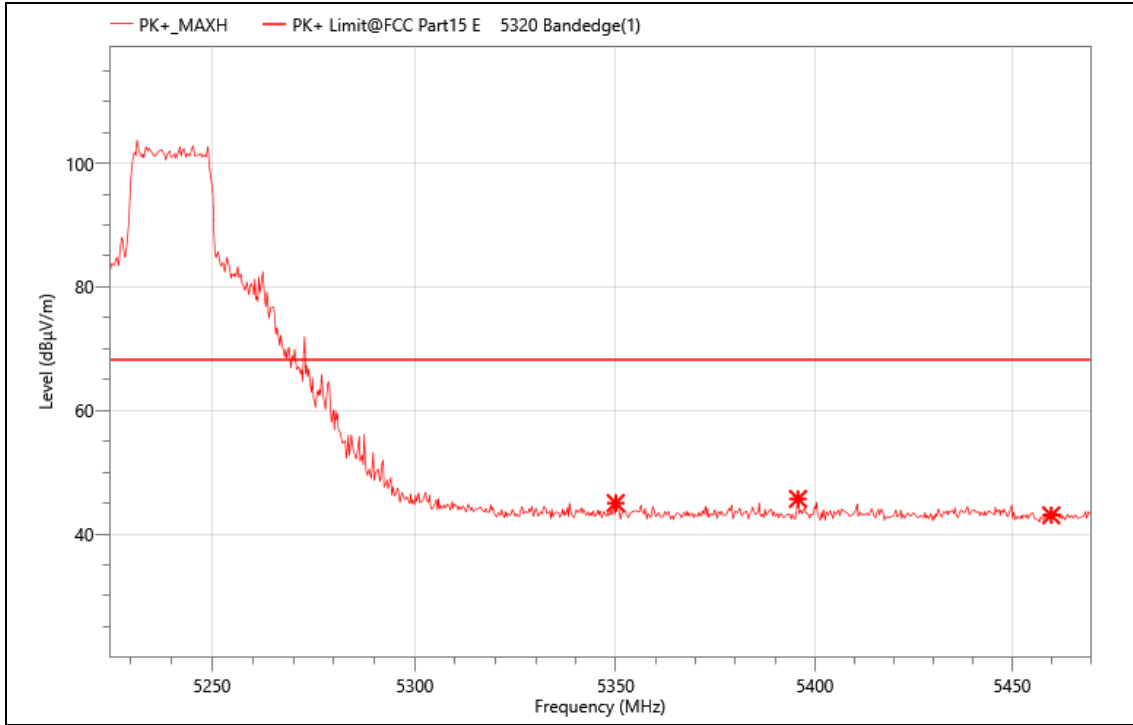

**Critical\_Freqs**

No.	Freq. (MHz)	Reading (dBµV)	Corr. (dB)	Meas. (dBµV/m)	Limit (dBµV/m)	Margin (dB)	Det.	Pol.
1	5350.000	55.04	-10.03	45.01	68.20	23.19	PK+	H
2	5395.765	55.44	-9.76	45.68	68.20	22.52	PK+	H
3	5460.000	53.29	-10.26	43.03	68.20	25.17	PK+	H

Note: [Margin=Limit-Meas.]; [Meas.=Reading+Corr.]



Mode:	5G WIFI 802.11ax HE20 5260MHz
Power:	AC 120V/60Hz
TE:	Berny
Date	2023/12/22
T/A/P	24.3□/54%/101Kpa

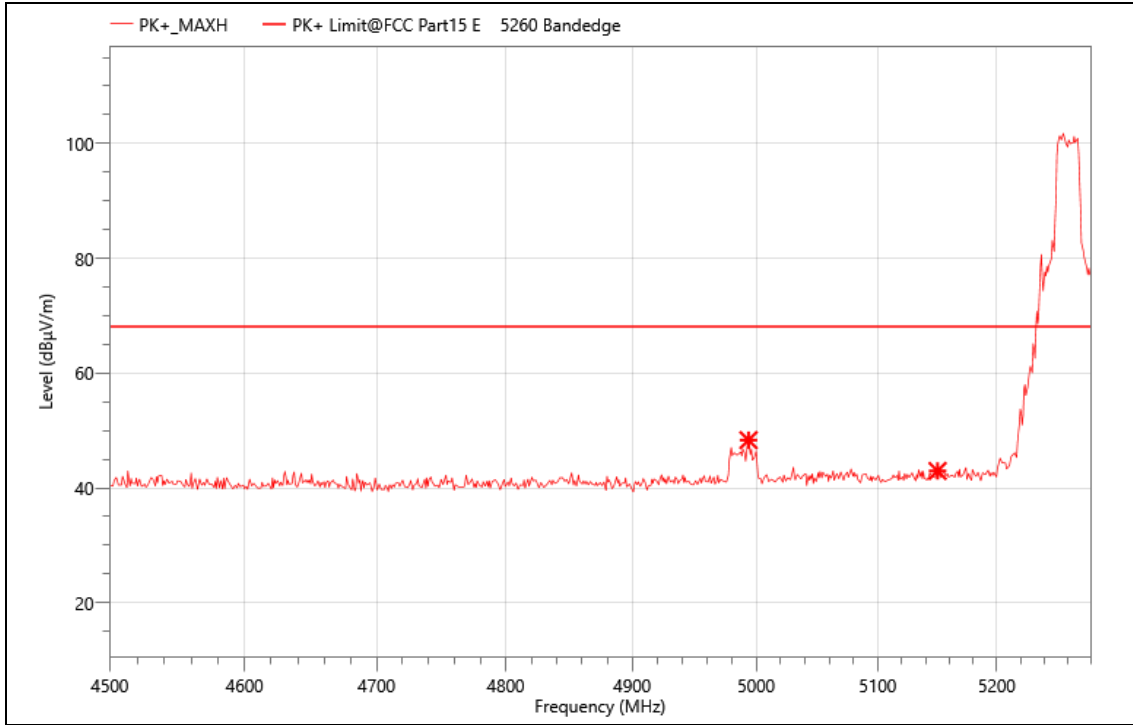

### Critical\_Freqs

No.	Freq. (MHz)	Reading (dBµV)	Corr. (dB)	Meas. (dBµV/m)	Limit (dBµV/m)	Margin (dB)	Det.	Pol.
1	4993.740	59.77	-11.43	48.34	68.20	19.86	PK+	H
2	5150.000	53.81	-10.84	42.97	68.20	25.23	PK+	H

Note: [Margin=Limit-Meas.]; [Meas.=Reading+Corr.]

Mode:	5G WIFI 802.11ax HE20 5260MHz
Power:	AC 120V/60Hz
TE:	Berny
Date	2023/12/22
T/A/P	24.3□/54%/101Kpa

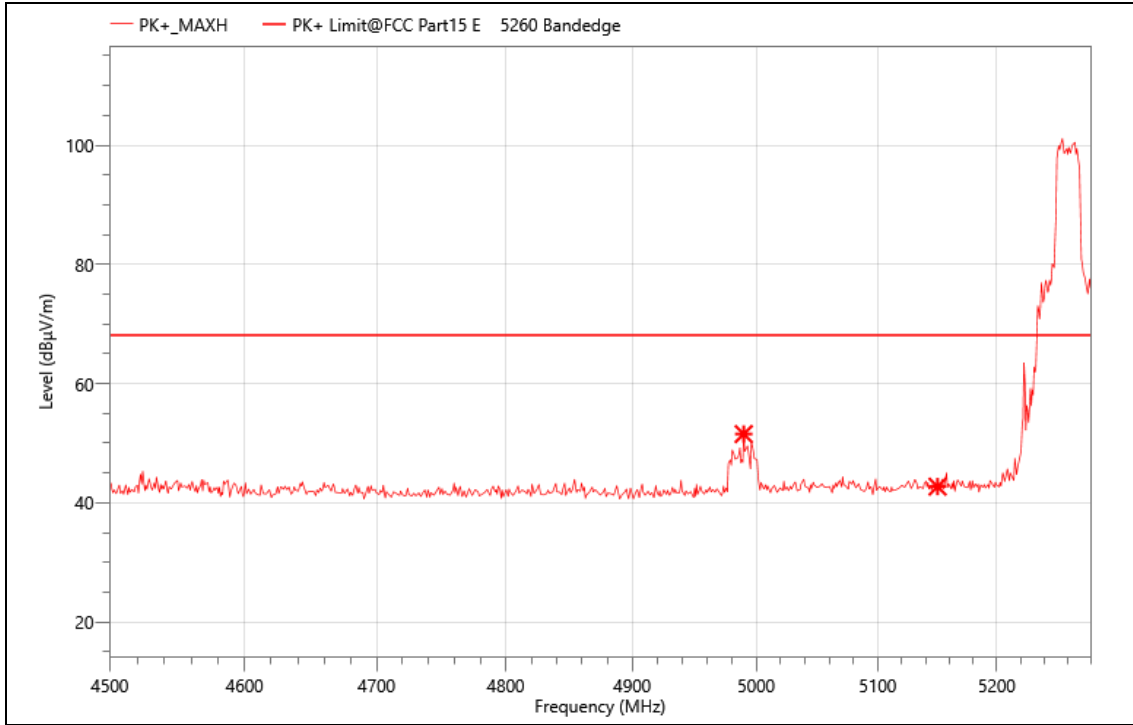

**Critical\_Freqs**

No.	Freq. (MHz)	Reading (dBµV)	Corr. (dB)	Meas. (dBµV/m)	Limit (dBµV/m)	Margin (dB)	Det.	Pol.
1	4989.840	62.99	-11.45	51.54	68.20	16.66	PK+	V
2	5150.000	53.55	-10.84	42.71	68.20	25.49	PK+	V

Note: [Margin=Limit-Meas.]; [Meas.=Reading+Corr.]

Mode:	5G WIFI 802.11ax HE20 5320MHz
Power:	AC 120V/60Hz
TE:	Berny
Date	2023/12/22
T/A/P	24.3□/54%/101Kpa

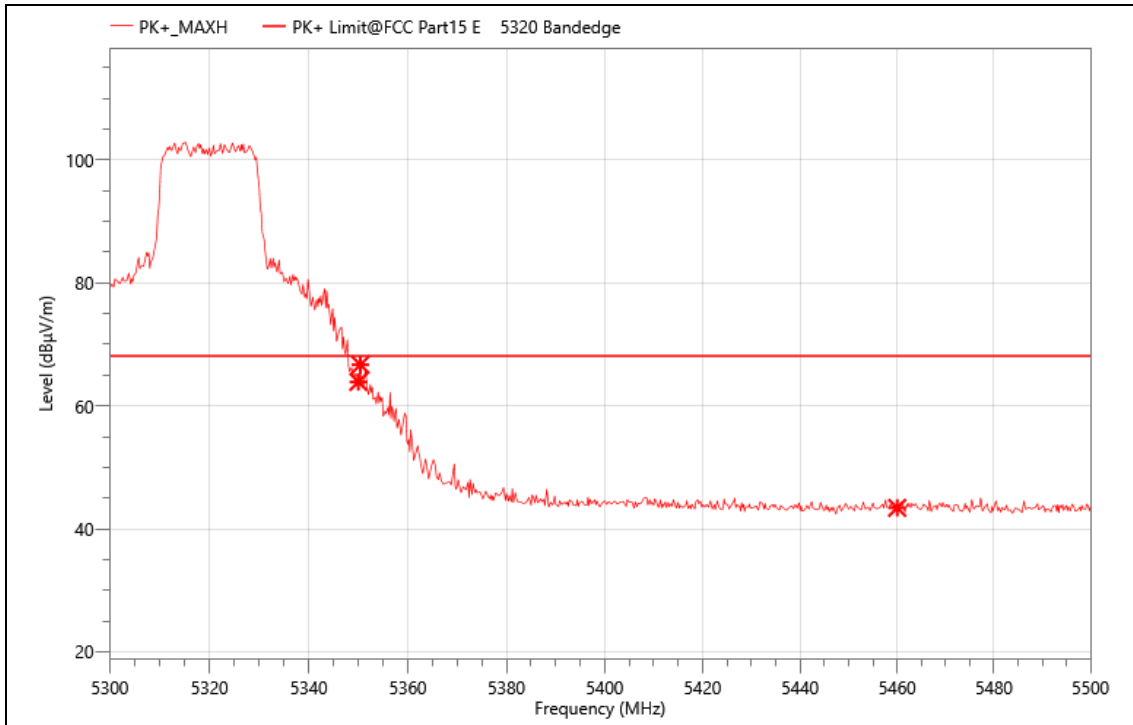

### Critical\_Freqs

No.	Freq. (MHz)	Reading (dBµV)	Corr. (dB)	Meas. (dBµV/m)	Limit (dBµV/m)	Margin (dB)	Det.	Pol.
1	5350.000	73.93	-10.03	63.90	68.20	4.30	PK+	H
2	5350.400	76.72	-10.02	66.70	68.20	1.50	PK+	H
3	5460.000	53.69	-10.26	43.43	68.20	24.77	PK+	H

Note: [Margin=Limit-Meas.]; [Meas.=Reading+Corr.]

Mode:	5G WIFI 802.11ax HE20 5320MHz
Power:	AC 120V/60Hz
TE:	Berny
Date	2023/12/22
T/A/P	24.3□/54%/101Kpa

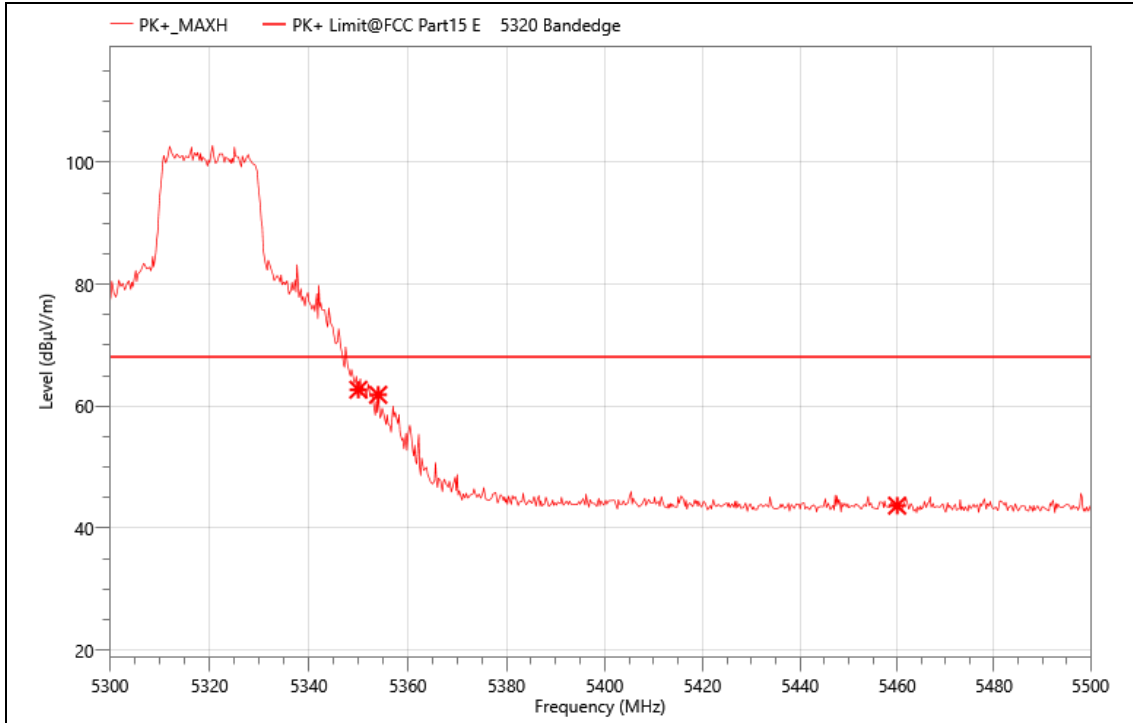

**Critical\_Freqs**

No.	Freq. (MHz)	Reading (dBµV)	Corr. (dB)	Meas. (dBµV/m)	Limit (dBµV/m)	Margin (dB)	Det.	Pol.
1	5350.000	72.73	-10.03	62.70	68.20	5.50	PK+	V
2	5354.000	71.80	-9.93	61.87	68.20	6.33	PK+	V
3	5460.000	53.94	-10.26	43.68	68.20	24.52	PK+	V

Note:

1. Measurement = Reading Level + Correct Factor.
2. If Peak Result complies with AV limit, AV Result is deemed to comply with AV limit.
3. Peak: Peak detector.
4. Only the worst data was recorded, if it complies with the limit, the other emissions deemed to comply with the limit.
5. 802.11a,802.11n HT20,802.11n HT40,802.11ac VHT20,802.11ac VHT40,802.11ac VHT80,802.11ac VHT160,802.11ax HE20,802.11ax HE40,802.11ax HE80 and 802.11ax HE160 were all tested, and only 802.11ax HE20 was recorded in the report as the worst mode.

Band IV(5.725-5.85 GHz)

Note: The main frequency is too far away from the restricted band and does not require testing.

## 9. AC POWER LINE CONDUCTED EMISSION

### LIMITS

Please refer to CFR 47 FCC §15.207 (a) and ISED RSS-Gen Clause 8.8

FREQUENCY (MHz)	Quasi-peak	Average
0.15 -0.5	66 - 56 *	56 - 46 *
0.50 -5.0	56.00	46.00
5.0 -30.0	60.00	50.00

### TEST PROCEDURE

Refer to ANSI C63.10-2013 clause 6.2.

The EUT is put on a table of non-conducting material that is 80 cm high. The vertical conducting wall of shielding is located 40 cm to the rear of the EUT. The power line of the EUT is connected to the AC mains through a Artificial Mains Network (A.M.N.). A EMI Measurement Receiver (R&S Test Receiver ESR3) is used to test the emissions from both sides of AC line. According to the requirements in Section 6.2 of ANSI C63.10-2013. Conducted emissions from the EUT measured in the frequency range between 0.15 MHz and 30 MHz using CISPR Quasi-Peak and average detector mode. The bandwidth of EMI test receiver is set at 9 kHz.

The arrangement of the equipment is installed to meet the standards and operating in a manner, which tends to maximize its emission characteristics in a normal application.

### TEST SETUP

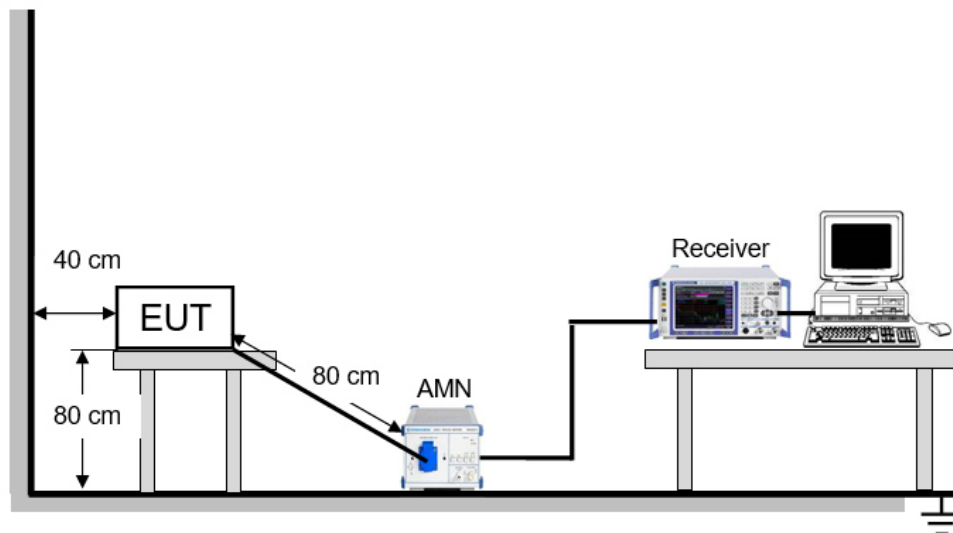

### TEST ENVIRONMENT

Temperature	26°C	Relative Humidity	54%
Atmosphere Pressure	101kPa		

**TEST RESULTS**

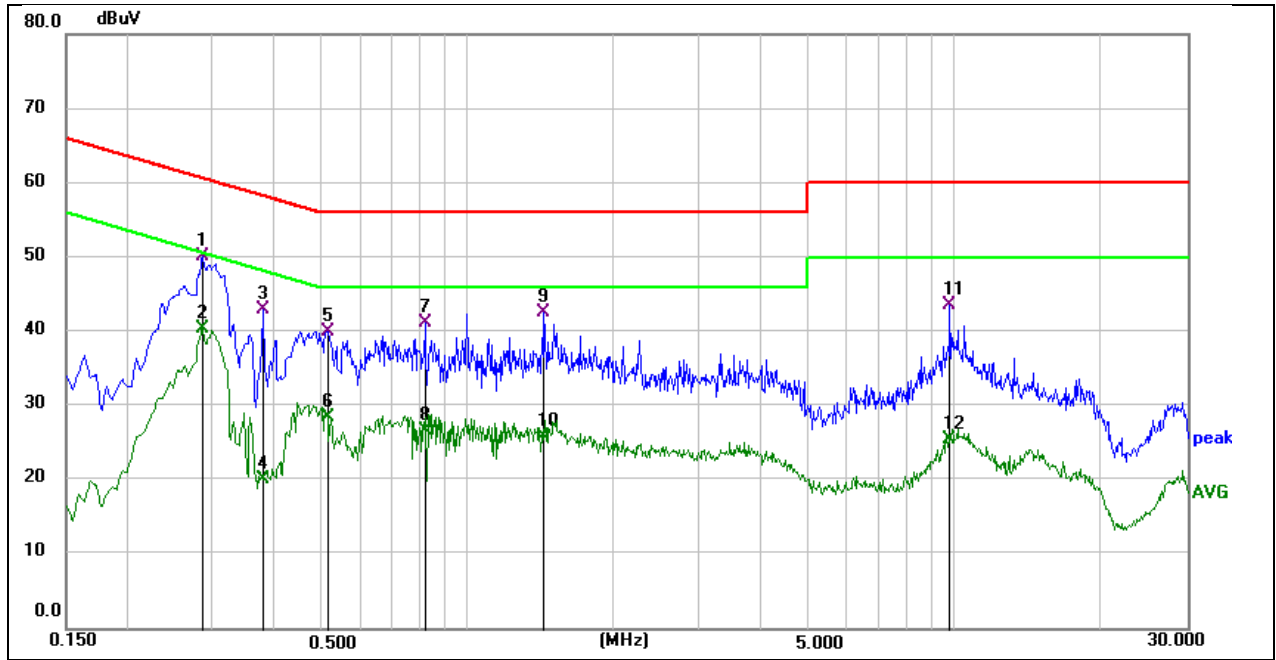

Phase: L1	Mode: 802.11ax HE20 5785MHz
-----------	-----------------------------

No.	Frequency (MHz)	Reading (dBuV)	Correct (dB)	Result (dBuV)	Limit (dBuV)	Margin (dB)	Remark
1	0.2850	40.23	9.82	50.05	60.67	-10.62	QP
2	0.2850	30.62	9.82	40.44	50.67	-10.23	AVG
3	0.3795	33.07	9.89	42.96	58.29	-15.33	QP
4	0.3795	10.31	9.89	20.20	48.29	-28.09	AVG
5	0.5144	30.10	9.91	40.01	56.00	-15.99	QP
6	0.5144	18.59	9.91	28.50	46.00	-17.50	AVG
7	0.8205	31.28	9.91	41.19	56.00	-14.81	QP
8	0.8205	16.77	9.91	26.68	46.00	-19.32	AVG
9	1.4370	32.81	9.82	42.63	56.00	-13.37	QP
10	1.4370	16.03	9.82	25.85	46.00	-20.15	AVG
11	9.7844	33.63	10.03	43.66	60.00	-16.34	QP
12	9.7844	15.39	10.03	25.42	50.00	-24.58	AVG

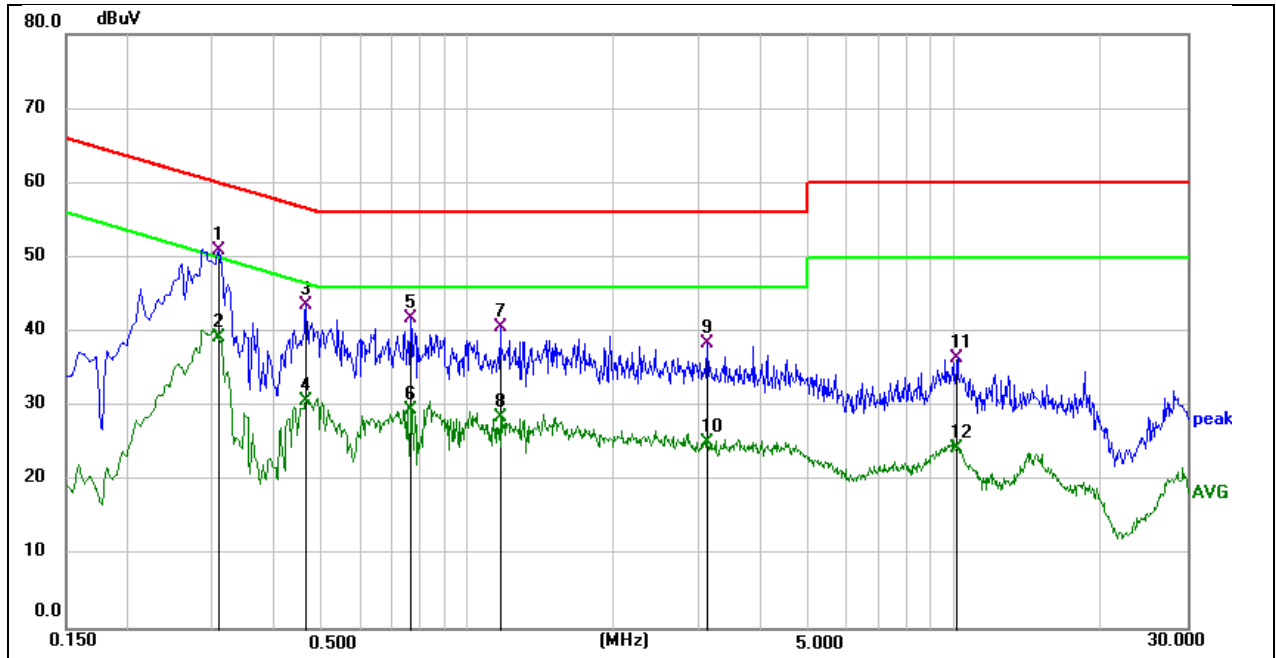

Phase: N	Mode: 802.11ax HE20 5785MHz
----------	-----------------------------

No.	Frequency (MHz)	Reading (dBuV)	Correct (dB)	Result (dBuV)	Limit (dBuV)	Margin (dB)	Remark
1	0.3074	41.17	9.70	50.87	60.04	-9.17	QP
2	0.3074	29.41	9.70	39.11	50.04	-10.93	AVG
3	0.4650	33.73	9.84	43.57	56.60	-13.03	QP
4	0.4650	20.90	9.84	30.74	46.60	-15.86	AVG
5	0.7664	31.94	9.84	41.78	56.00	-14.22	QP
6	0.7664	19.63	9.84	29.47	46.00	-16.53	AVG
7	1.1670	30.91	9.77	40.68	56.00	-15.32	QP
8	1.1670	18.66	9.77	28.43	46.00	-17.57	AVG
9	3.1110	28.50	9.94	38.44	56.00	-17.56	QP
10	3.1110	15.16	9.94	25.10	46.00	-20.90	AVG
11	10.1489	26.46	10.02	36.48	60.00	-23.52	QP
12	10.1489	14.26	10.02	24.28	50.00	-25.72	AVG

## 10. ANTENNA REQUIREMENT

### REQUIREMENT

Please refer to FCC §15.203

An intentional radiator shall be designed to ensure that no antenna other than that furnished by the responsible party shall be used with the device. The use of a permanently attached antenna or of an antenna that uses a unique coupling to the intentional radiator shall be considered sufficient to comply with the provisions of this section. The manufacturer may design the unit so that a broken antenna can be replaced by the user, but the use of a standard antenna jack or electrical connector is prohibited.

Please refer to FCC §15.407(a)(1)(2)(3)

If transmitting antennas of directional gain greater than 6 dBi are used, both the maximum conducted output power and the maximum power spectral density shall be reduced by the amount in dB that the directional gain of the antenna exceeds 6 dBi.

Standard	Requirement
RSS-Gen issue 5 6.8.	<p>The applicant for equipment certification shall provide a list of all antenna types that may be used with the transmitter, where applicable (i.e. for transmitters with detachable antenna), indicating the maximum permissible antenna gain (in dBi) and the required impedance for each antenna. The test report shall demonstrate the compliance of the transmitter with the limit for maximum equivalent isotropically radiated power (e.i.r.p.) specified in the applicable RSS, when the transmitter is equipped with any antenna type, selected from this list.</p> <p>For expediting the testing, measurements may be performed using only the antenna with highest gain of each combination of transmitter and antenna type, with the transmitter output power set at the maximum level. However, the transmitter shall comply with the applicable requirements under all operational conditions and when in combination with any type of antenna from the list provided in the test report (and in the notice to be included in the user manual, provided below).</p> <p>When measurements at the antenna port are used to determine the RF output power, the effective gain of the device's antenna shall be stated, based on a measurement or on data from the antenna's manufacturer.</p> <p>The test report shall state the RF power, output power setting and spurious emission measurements with each antenna type that is used with the transmitter being tested.</p> <p>For licence-exempt equipment with detachable antennas, the user manual shall also contain the following notice in a conspicuous location:</p> <p>This radio transmitter [enter the device's ISED certification number] has been approved by Innovation, Science and Economic Development Canada to operate with the antenna types listed below, with the maximum permissible gain indicated. Antenna types not included in this list that have a gain greater than the maximum gain indicated for any type listed are strictly prohibited for use with this device.</p>



	Immediately following the above notice, the manufacturer shall provide a list of all antenna types which can be used with the transmitter, indicating the maximum permissible antenna gain (in dBi) and the required impedance for each antenna type.
--	---

**DESCRIPTION**

Pass

## APPENDIX: PHOTOGRAPHS OF TEST CONFIGURATION

### AC Power Line Conducted Emission



### Radiated Emissions and Band Edge Measurement

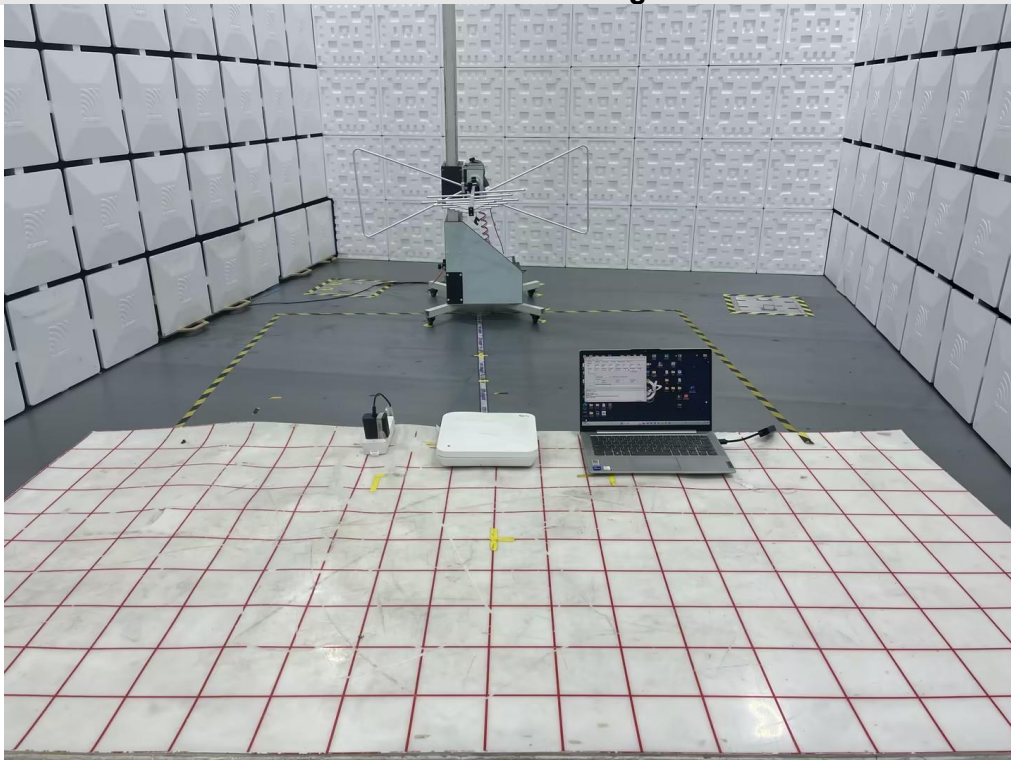



**END OF REPORT**