

S

T

S

L

A

B



RADIO TEST REPORT

Report No.: STS2107180W02

Issued for

Shenzhen Tyroq Smart Technology Co.,Ltd

Floor 1, Building 2, Zaimao Industry Park, Bantian Town, Longgang District, Shenzhen, China

Product Name:	TWS earbuds
Brand Name:	N/A
Model Name:	Amplifears
Series Model:	TY31
FCC ID:	2A2PT-AMPLIFI
Test Standard:	FCC Part 15.247

Any reproduction of this document must be done in full. No single part of this document may be reproduced without permission from STS, all test data presented in this report is only applicable to presented test sample.

Shenzhen STS Test Services Co., Ltd.
A 1/F, Building B, Zhuoke Science Park, No.190 Chongqing Road, HepingShequ,
Fuyong Sub-District, Bao'an District, Shenzhen, Guang Dong, China
TEL: +86-755 3688 6288 FAX: +86-755 3688 6277 E-mail: sts@stsapp.com





TEST RESULT CERTIFICATION

Applicant's Name.....: Shenzhen Tyroq Smart Technology Co.,Ltd
 Address: Floor 1,Building 2,Zaimao Industry Park,BantianTown,Longgang District,Shenzhen, China
Manufacturer's Name: Shenzhen Tyroq Smart Technology Co.,Ltd
 Address: Floor 1,Building 2,Zaimao Industry Park,BantianTown,Longgang District,Shenzhen, China

Product Description

Product Name.....: TWS earbuds
 Brand Name: N/A
 Model Name: Amplifears
 Series Model.....: TY31

Test Standards.....: FCC Part15.247
 Test Procedure: ANSI C63.10-2013

This device described above has been tested by STS, the test results show that the equipment under test (EUT) is in compliance with the FCC requirements. And it is applicable only to the tested sample identified in the report.
 This report shall not be reproduced except in full, without the written approval of STS, this document may be altered or revised by STS, personal only, and shall be noted in the revision of the document.

Date of Test.....:
 Date of receipt of test item: 27 July 2021
 Date (s) of performance of tests: 27 July 2021~ 25 Aug. 2021
 Date of Issue.....: 25 Aug. 2021
 Test Result.....: **Pass**

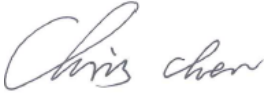
Testing Engineer : 

 (Chris Chen)

Technical Manager : 

 (Sean she)

Authorized Signatory : 

 (Vita Li)





Table of Contents

1. SUMMARY OF TEST RESULTS	6
1.1 TEST FACTORY	7
1.2 MEASUREMENT UNCERTAINTY	7
2. GENERAL INFORMATION	8
2.1 GENERAL DESCRIPTION OF THE EUT	8
2.2 DESCRIPTION OF THE TEST MODES	10
2.3 TEST SOFTWARE AND POWER LEVEL	10
2.4 BLOCK DIAGRAM SHOWING THE CONFIGURATION OF SYSTEM TESTED	11
2.5 DESCRIPTION OF NECESSARY ACCESSORIES AND SUPPORT UNITS	12
2.6 EQUIPMENTS LIST	13
3. EMC EMISSION TEST	15
3.1 CONDUCTED EMISSION MEASUREMENT	15
3.2 TEST PROCEDURE	16
3.3 TEST SETUP	16
3.4 EUT OPERATING CONDITIONS	16
3.5 TEST RESULTS	17
4. RADIATED EMISSION MEASUREMENT	19
4.1 RADIATED EMISSION LIMITS	19
4.2 TEST PROCEDURE	21
4.3 TEST SETUP	22
4.4 EUT OPERATING CONDITIONS	22
4.5 FIELD STRENGTH CALCULATION	23
4.6 TEST RESULTS	24
5. CONDUCTED SPURIOUS & BAND EDGE EMISSION	37
5.1 LIMIT	37
5.2 TEST PROCEDURE	37
5.3 TEST SETUP	37
5.4 EUT OPERATION CONDITIONS	37
5.5 TEST RESULTS	38
6. POWER SPECTRAL DENSITY TEST	46
6.1 LIMIT	46
6.2 TEST PROCEDURE	46
6.3 TEST SETUP	46



Table of Contents

6.4 EUT OPERATION CONDITIONS	46
6.5 TEST RESULTS	47
7. BANDWIDTH TEST	51
7.1 LIMIT	51
7.2 TEST PROCEDURE	51
7.3 TEST SETUP	51
7.4 EUT OPERATION CONDITIONS	51
7.5 TEST RESULTS	52
8. PEAK OUTPUT POWER TEST	56
8.1 LIMIT	56
8.2 TEST PROCEDURE	56
8.3 TEST SETUP	56
8.4 EUT OPERATION CONDITIONS	56
8.5 TEST RESULTS	57
9. ANTENNA REQUIREMENT	59
9.1 STANDARD REQUIREMENT	59
9.2 EUT ANTENNA	59
10. EUT TEST PHOTO	60



Revision History

Rev.	Issue Date	Report NO.	Effect Page	Contents
00	25 Aug. 2021	STS2107180W02	ALL	Initial Issue





1. SUMMARY OF TEST RESULTS

Test procedures according to the technical standards:
KDB 558074 D01 15.247 Meas Guidance v05r02.

FCC Part 15.247, Subpart C			
Standard Section	Test Item	Judgment	Remark
15.207	Conducted Emission	PASS	--
15.247 (a)(2)	6dB Bandwidth	PASS	--
15.247 (b)(3)	Output Power	PASS	--
15.209	Radiated Spurious Emission	PASS	--
15.247 (d)	Conducted Spurious & Band Edge Emission	PASS	--
15.247 (e)	Power Spectral Density	PASS	--
15.205	Restricted Band Edge Emission	PASS	--
Part 15.247(d)/ Part 15.209(a)	Band Edge Emission	PASS	--
15.203	Antenna Requirement	PASS	--

NOTE:

- (1) 'N/A' denotes test is not applicable in this Test Report.
- (2) All tests are according to ANSI C63.10-2013.



1.1 TEST FACTORY

SHENZHEN STS TEST SERVICES CO., LTD

Add. : A 1/F, Building B, Zhuoke Science Park, No.190 Chongqing Road, HepingShequ, Fuyong Sub-District, Bao'an District, Shenzhen, Guang Dong, China

FCC test Firm Registration Number: 625569

IC test Firm Registration Number: 12108A

A2LA Certificate No.: 4338.01

1.2 MEASUREMENT UNCERTAINTY

The reported uncertainty of measurement $y \pm U$, where expanded uncertainty U is based on a standard uncertainty multiplied by a coverage factor of $k=2$, providing a level of confidence of approximately **95** %.

No.	Item	Uncertainty
1	RF output power, conducted	$\pm 0.68\text{dB}$
2	Unwanted Emissions, conducted	$\pm 2.988\text{dB}$
3	All emissions, radiated 9K-30MHz	$\pm 2.84\text{dB}$
4	All emissions, radiated 30M-1GHz	$\pm 4.39\text{dB}$
5	All emissions, radiated 1G-6GHz	$\pm 5.10\text{dB}$
6	All emissions, radiated >6G	$\pm 5.48\text{dB}$
7	Conducted Emission (9KHz-150KHz)	$\pm 2.79\text{dB}$
8	Conducted Emission (150KHz-30MHz)	$\pm 2.80\text{dB}$



2. GENERAL INFORMATION

2.1 GENERAL DESCRIPTION OF THE EUT

Product Name	TWS earbuds	
Trade Name	N/A	
Model Name	Amplifieurs	
Series Model	TY31	
Model Difference	Product model names are different	
Product Description	The EUT is a TWS earbuds	
	Operation Frequency:	2402~2480 MHz
	Modulation Type:	GFSK
	Radio Technology:	BLE
	Bluetooth Version:	5.2
	Bluetooth Configuration:	LE(Support 1M PHY, 2M PHY)
	Number Of Channel:	40
	Antenna Designation:	Please refer to the Note 3.
	Antenna Gain (dBi)	1.15dBi
Channel List	Please refer to the Note 2.	
Rating	Input: 5V/30mA	
Battery	Earphone Rated Voltage:3.7V Charge Limit Voltage:4.2V Capacity: 30mAh	
	Charging Box Rated Voltage:3.7V Charge Limit Voltage:4.2V Capacity: 300mAh	
Hardware version number	V2.0	
Software version number	V1.0.2	
Connecting I/O Port(s)	Please refer to the Note 1.	

Note:

1. For a more detailed features description, please refer to the manufacturer's specifications or the User Manual.



2.

Channel List							
Channel	Frequency (MHz)	Channel	Frequency (MHz)	Channel	Frequency (MHz)	Channel	Frequency (MHz)
00	2402	10	2422	20	2442	30	2462
01	2404	11	2424	21	2444	31	2464
02	2406	12	2426	22	2446	32	2466
03	2408	13	2428	23	2448	33	2468
04	2410	14	2430	24	2450	34	2470
05	2412	15	2432	25	2452	35	2472
06	2414	16	2434	26	2454	36	2474
07	2416	17	2436	27	2456	37	2476
08	2418	18	2438	28	2458	38	2478
09	2420	19	2440	29	2460	39	2480

3.

Table for Filed Antenna

Ant.	Brand	Model Name	Antenna Type	Connector	Gain (dBi)	NOTE
1	N/A	Amplifieurs	Ceramic	N/A	1.15dBi	BLE ANT

Note: The antenna information refer the manufacturer provide report, applicable only to the tested sample identified in the report.

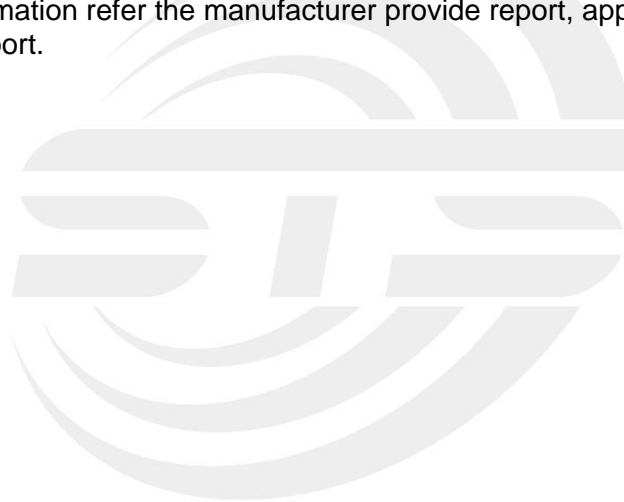



2.2 DESCRIPTION OF THE TEST MODES

For conducted test items and radiated spurious emissions
Each of these EUT operation mode(s) or test configuration mode(s) mentioned below was evaluated respectively.

Worst Mode	Description	Data/Modulation
Mode 1	TX CH00(2402MHz)	1 MHz/GFSK
Mode 2	TX CH19(2440MHz)	1 MHz/GFSK
Mode 3	TX CH39(2480MHz)	1 MHz/GFSK

Worst Mode	Description	Data/Modulation
Mode 1	TX CH00(2402MHz)	2M PHY /GFSK
Mode 2	TX CH19(2440MHz)	2M PHY /GFSK
Mode 3	TX CH39(2480MHz)	2M PHY /GFSK

Note:

- (1) The measurements are performed at all Bit Rate of Transmitter, the worst data was reported.
- (2) We have be tested for all avaiable U.S. voltage and frequencies(For 120V,50/60Hz and 240V, 50/60Hz) for which the device is capable of operation, and the worst case of 120V/60Hz is shown in the report.
- (3) The battery is fully-charged during the radited and RF conducted test.

For AC Conducted Emission

Test Case	
AC Conducted Emission	Mode 4 : Keeping BT TX

2.3 TEST SOFTWARE AND POWER LEVEL

During testing channel & power controlling software provided by the customer was used to control the operating channel as well as the output power level.

RF Function	Type	Mode Or Modulation type	ANT Gain(dBi)	Power Class	Software For Testing
BLE(With 2M PHY)	BLE_1M PHY	GFSK	1.15	default	AWRDLABV2
	BLE_2M PHY	GFSK	1.15	default	

2.4 BLOCK DIAGRAM SHOWING THE CONFIGURATION OF SYSTEM TESTED

Radiated Spurious Emission Test

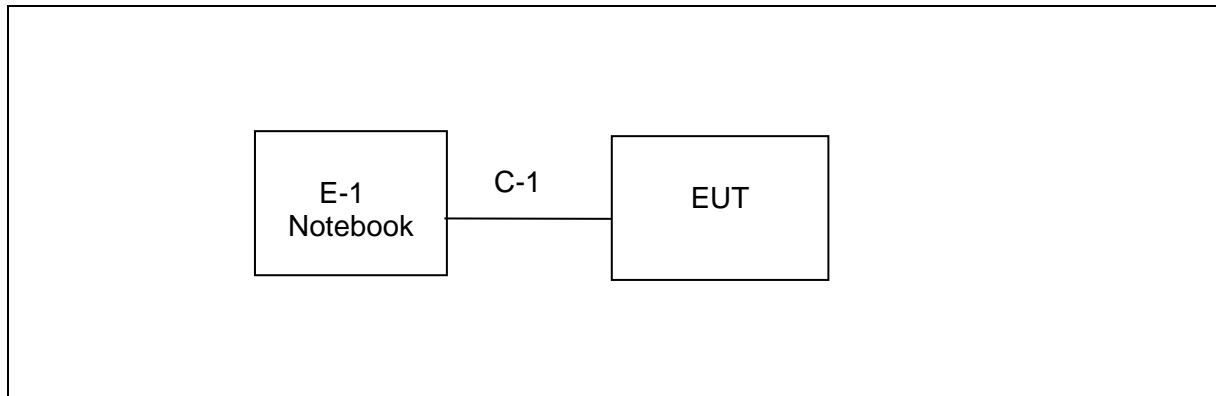

Conducted Emission Test

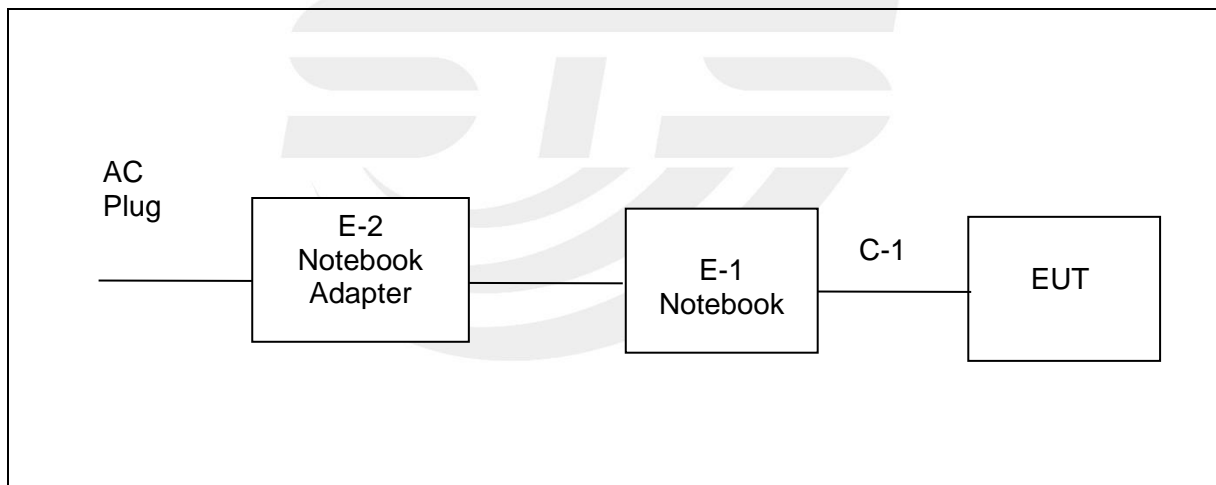



2.5 DESCRIPTION OF NECESSARY ACCESSORIES AND SUPPORT UNITS

The EUT has been tested as an independent unit together with other necessary accessories or support units. The following support units or accessories were used to form a representative test configuration during the tests.

Necessary accessories

Item	Equipment	Mfr/Brand	Model/Type No.	Length	Note
N/A	N/A	N/A	N/A	N/A	N/A

Support units

Item	Equipment	Mfr/Brand	Model/Type No.	Length	Note
E-2	Notebook Adapter	LENOVO	ADLX45DLC3A	N/A	N/A
E-1	Notebook	LENOVO	ThinkPad E470	N/A	N/A
C-1	USB Cable	N/A	N/A	150cm	N/A

Note:

- (1) For detachable type I/O cable should be specified the length in cm in 『Length』 column.
- (2) “YES” is means “with core”; “NO” is means “without core”.



2.6 EQUIPMENTS LIST

Radiation Test equipment

Kind of Equipment	Manufacturer	Type No.	Serial No.	Last calibration	Calibrated until
Test Receiver	R&S	ESCI	101427	2020.10.12	2021.10.11
Signal Analyzer	R&S	FSV 40-N	101823	2020.10.10	2021.10.09
Active loop Antenna	ZHINAN	ZN30900C	16035	2021.04.11	2022.04.10
Bilog Antenna	TESEQ	CBL6111D	34678	2020.10.12	2022.10.11
Horn Antenna	SCHWARZBECK	BBHA 9120D	02014	2019.10.15	2021.10.14
SHF-EHF Horn Antenna (18G-40GHz)	A-INFO	LB-180400-KF	J211020657	2020.10.12	2022.10.11
Pre-Amplifier (0.1M-3GHz)	EM	EM330	060665	2020.10.12	2021.10.11
Pre-Amplifier (1G-18GHz)	SKET	LNPA-01018G-45	SK2018080901	2020.10.12	2021.10.11
Pre-Amplifier (18G-40GHz)	SKET	LNPA-1840-50	SK2018101801	2020.10.10	2021.10.09
Temperature & Humidity	HH660	Mieo	N/A	2020.10.13	2021.10.12
Turn table	EM	SC100_1	60531	N/A	N/A
Antenna mast	EM	SC100	N/A	N/A	N/A
Test SW	FARAD	EZ-EMC(Ver.STSLAB-03A1 RE)			

Conduction Test equipment

Kind of Equipment	Manufacturer	Type No.	Serial No.	Last calibration	Calibrated until
Test Receiver	R&S	ESCI	101427	2020.10.12	2021.10.11
LISN	R&S	ENV216	101242	2020.10.12	2021.10.11
LISN	EMCO	3810/2NM	23625	2020.10.12	2022.10.11
Temperature & Humidity	HH660	Mieo	N/A	2020.10.13	2021.10.12
Test SW	FARAD	EZ-EMC(Ver.STSLAB-03A1 RE)			



RF Connected Test

Kind of Equipment	Manufacturer	Type No.	Serial No.	Last calibration	Calibrated until
Power Sensor	Keysight	U2021XA	MY55520005	2020.10.10	2021.10.09
			MY55520006	2020.10.10	2021.10.09
			MY56120038	2020.10.10	2021.10.09
			MY56280002	2020.10.10	2021.10.09
Signal Analyzer	Agilent	N9020A	MY51110105	2021.03.04	2022.03.03
Temperature & Humidity	HH660	Mieo	N/A	2020.10.13	2021.10.12
Test SW	FARAD	EZ-EMC(Ver.STSLAB-03A1 RE)			





3. EMC EMISSION TEST

3.1 CONDUCTED EMISSION MEASUREMENT

3.1.1 POWER LINE CONDUCTED EMISSION LIMITS

The radio frequency voltage that is conducted back onto the AC power line on any frequency or frequencies, within the band 150 kHz to 30 MHz, shall not exceed the limits in the following table.

FREQUENCY (MHz)	Conducted Emission limit (dBuV)	
	Quasi-peak	Average
0.15 -0.5	66 - 56 *	56 - 46 *
0.50 -5.0	56.00	46.00
5.0 -30.0	60.00	50.00

Note:

- (1) The tighter limit applies at the band edges.
- (2) The limit of “ * ” marked band means the limitation decreases linearly with the logarithm of the frequency in the range.

The following table is the setting of the receiver

Receiver Parameters	Setting
Attenuation	10 dB
Start Frequency	0.15 MHz
Stop Frequency	30 MHz
IF Bandwidth	9 kHz

3.2 TEST PROCEDURE

- a. The EUT is 0.8 m from the horizontal ground plane and 0.4 m from the vertical ground plane with EUT being connected to the power mains through a line impedance stabilization network (LISN). All other support equipments are powered from additional LISN(s). The LISN provides 50 Ohm/ 50uH of coupling impedance for the measuring instrument.
- b. Interconnecting cables that hang closer than 40 cm to the ground plane shall be folded back and forth in the center forming a bundle 30 to 40 cm long.
- c. I/O cables that are not connected to a peripheral shall be bundled in the center. The end of the cable may be terminated, if required, using the correct terminating impedance. The overall length shall not exceed 1 m.
- d. LISN is at least 80 cm from the nearest part of EUT chassis.
- e. For the actual test configuration, please refer to the related Item –EUT Test Photos.

3.3 TEST SETUP

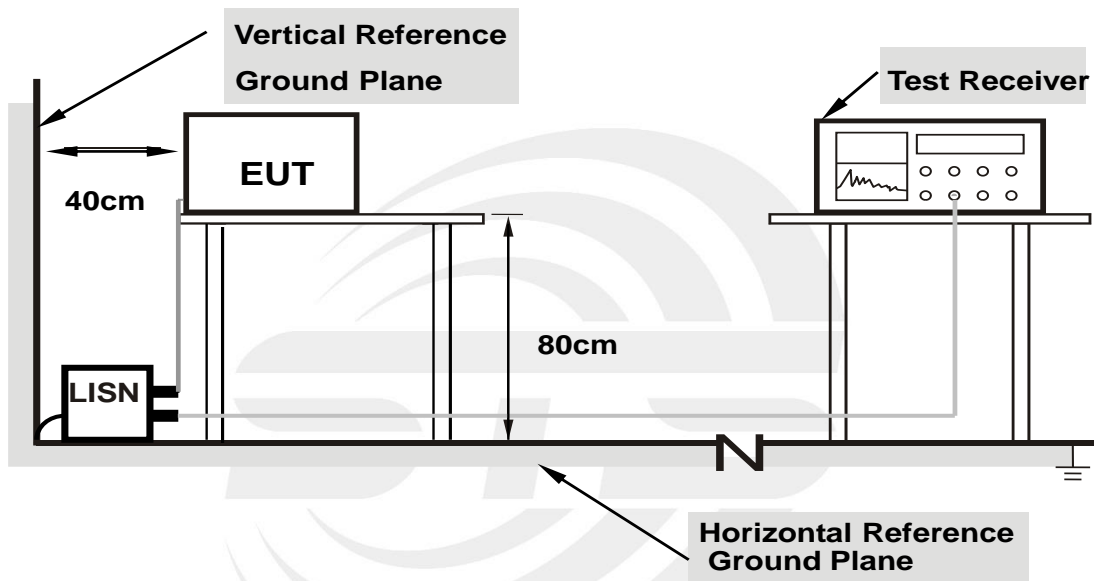

- Note: 1. Support units were connected to second LISN.**
- 2. Both of LISNs (AMN) are 80 cm from EUT and at least 80 cm from other units and other metal planes support units.**

3.4 EUT OPERATING CONDITIONS

The EUT was configured for testing in a typical fashion (as a customer would normally use it). The EUT has been programmed to continuously transmit during test. This operating condition was tested and used to collect the included data.



3.5 TEST RESULTS

Temperature:	21.8(C)	Relative Humidity:	54%RH
Test Voltage:	AC 120V/60Hz	Phase:	L
Test Mode:	Mode 4		

No.	Frequency (MHz)	Reading (dBuV)	Correct Factor(dB)	Result (dBuV)	Limit (dBuV)	Margin (dB)	Remark
1	0.1500	34.51	20.29	54.80	66.00	-11.20	QP
2	0.1500	10.34	20.29	30.63	56.00	-25.37	AVG
3	0.3860	14.20	20.60	34.80	58.15	-23.35	QP
4	0.3860	1.75	20.60	22.35	48.15	-25.80	AVG
5	2.0420	18.44	20.39	38.83	56.00	-17.17	QP
6	2.0420	8.70	20.39	29.09	46.00	-16.91	AVG
7	4.5060	11.11	20.53	31.64	56.00	-24.36	QP
8	4.5060	-1.56	20.53	18.97	46.00	-27.03	AVG
9	9.7780	7.59	20.90	28.49	60.00	-31.51	QP
10	9.7780	-3.78	20.90	17.12	50.00	-32.88	AVG
11	21.3380	7.53	22.86	30.39	60.00	-29.61	QP
12	21.3380	-2.97	22.86	19.89	50.00	-30.11	AVG

Remark:

1. All readings are Quasi-Peak and Average values
2. Margin = Result (Result = Reading + Factor) – Limit
3. Factor = LISN factor + Cable loss + Limiter (10dB)

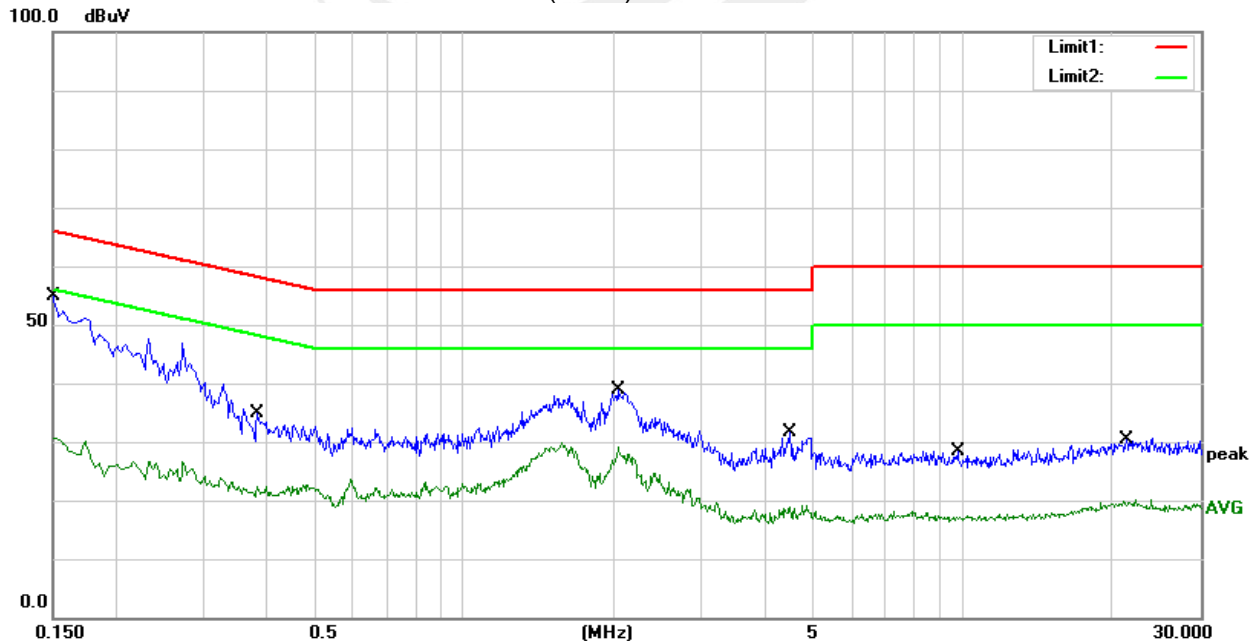



Temperature:	21.8(C)	Relative Humidity:	54%RH
Test Voltage:	AC 120V/60Hz	Phase:	N
Test Mode:	Mode 4		

No.	Frequency (MHz)	Reading (dBuV)	Correct Factor(dB)	Result (dBuV)	Limit (dBuV)	Margin (dB)	Remark
1	0.1500	32.67	20.29	52.96	66.00	-13.04	QP
2	0.1500	13.26	20.29	33.55	56.00	-22.45	AVG
3	0.5300	16.92	20.47	37.39	56.00	-18.61	QP
4	0.5300	4.81	20.47	25.28	46.00	-20.72	AVG
5	2.0220	19.31	20.39	39.70	56.00	-16.30	QP
6	2.0220	9.58	20.39	29.97	46.00	-16.03	AVG
7	4.6140	13.32	20.52	33.84	56.00	-22.16	QP
8	4.6140	-0.08	20.52	20.44	46.00	-25.56	AVG
9	9.5100	11.20	20.87	32.07	60.00	-27.93	QP
10	9.5100	0.49	20.87	21.36	50.00	-28.64	AVG
11	22.9260	9.97	22.80	32.77	60.00	-27.23	QP
12	22.9260	-0.80	22.80	22.00	50.00	-28.00	AVG

Remark:

1. All readings are Quasi-Peak and Average values
2. Margin = Result (Result =Reading + Factor)–Limit
3. Factor=LISN factor+Cable loss+Limiter (10dB)

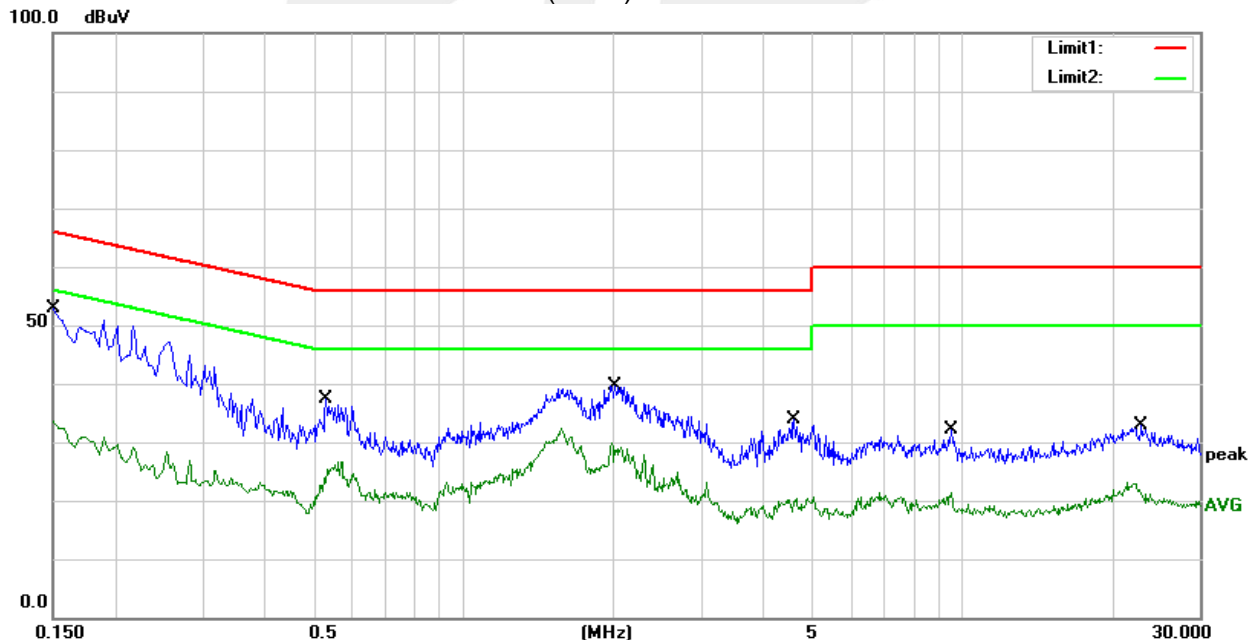



4. RADIATED EMISSION MEASUREMENT

4.1 RADIATED EMISSION LIMITS

In case the emission fall within the Restricted band specified on Part15.205 (a)&209(a) limit in the table and according to ANSI C63.10-2013 below has to be followed.

LIMITS OF RADIATED EMISSION MEASUREMENT (0.009MHz - 1000MHz)

Frequencies (MHz)	Field Strength (microrvolts/meter)	Measurement Distance (meters)
0.009~0.490	2400/F(KHz)	300
0.490~1.705	24000/F(KHz)	30
1.705~30.0	30	30
30~88	100	3
88~216	150	3
216~960	200	3
Above 960	500	3

LIMITS OF RADIATED EMISSION MEASUREMENT (1GHz-25 GHz)

FREQUENCY (MHz)	(dBuV/m) (at 3M)	
	PEAK	AVERAGE
Above 1000	74	54

Notes:

- (1) The limit for radiated test was performed according to FCC PART 15C.
- (2) The tighter limit applies at the band edges.
- (3) Emission level (dBuV/m)=20log Emission level (uV/m).

LIMITS OF RESTRICTED FREQUENCY BANDS

FREQUENCY (MHz)	FREQUENCY (MHz)	FREQUENCY (MHz)	FREQUENCY (GHz)
0.090-0.110	16.42-16.423	399.9-410	4.5-5.15
0.495-0.505	16.69475-16.69525	608-614	5.35-5.46
2.1735-2.1905	16.80425-16.80475	960-1240	7.25-7.75
4.125-4.128	25.5-25.67	1300-1427	8.025-8.5
4.17725-4.17775	37.5-38.25	1435-1626.5	9.0-9.2
4.20725-4.20775	73-74.6	1645.5-1646.5	9.3-9.5
6.215-6.218	74.8-75.2	1660-1710	10.6-12.7
6.26775-6.26825	108-121.94	1718.8-1722.2	13.25-13.4
6.31175-6.31225	123-138	2200-2300	14.47-14.5
8.291-8.294	149.9-150.05	2310-2390	15.35-16.2
8.362-8.366	156.52475-156.52525	2483.5-2500	17.7-21.4
8.37625-8.38675	156.7-156.9	2690-2900	22.01-23.12
8.41425-8.41475	162.0125-167.17	3260-3267	23.6-24.0
12.29-12.293	167.72-173.2	3332-3339	31.2-31.8
12.51975-12.52025	240-285	3345.8-3358	36.43-36.5
12.57675-12.57725	322-335.4	3600-4400	Above 38.6
13.36-13.41			



For Radiated Emission

Spectrum Parameter	Setting
Attenuation	Auto
Detector	Peak/QP/AV
Start Frequency	9 KHz/150KHz(Peak/QP/AV)
Stop Frequency	150KHz/30MHz(Peak/QP/AV)
RB / VB (emission in restricted band)	200Hz (From 9kHz to 0.15MHz)/ 9KHz (From 0.15MHz to 30MHz); 200Hz (From 9kHz to 0.15MHz)/ 9KHz (From 0.15MHz to 30MHz)

Spectrum Parameter	Setting
Attenuation	Auto
Detector	Peak/QP
Start Frequency	30 MHz(Peak/QP)
Stop Frequency	1000 MHz (Peak/QP)
RB / VB (emission in restricted band)	120 KHz / 300 KHz

Spectrum Parameter	Setting
Attenuation	Auto
Detector	Peak/AV
Start Frequency	1000 MHz(Peak/AV)
Stop Frequency	10th carrier hamonic(Peak/AV)
RB / VB (emission in restricted band)	1 MHz / 3 MHz(Peak) 1 MHz/1/T MHz(AVG)

For Restricted band

Spectrum Parameter	Setting
Detector	Peak/AV
Start/Stop Frequency	Lower Band Edge: 2310 to 2410 MHz Upper Band Edge: 2475 to 2500 MHz
RB / VB	1 MHz / 3 MHz(Peak) 1 MHz/1/T MHz(AVG)



Receiver Parameter	Setting
Start ~ Stop Frequency	9kHz~90kHz / RB 200Hz for PK & AV
Start ~ Stop Frequency	90kHz~110kHz / RB 200Hz for QP
Start ~ Stop Frequency	110kHz~490kHz / RB 200Hz for PK & AV
Start ~ Stop Frequency	490kHz~30MHz / RB 9kHz for QP
Start ~ Stop Frequency	30MHz~1000MHz / RB 120kHz for QP

4.2 TEST PROCEDURE

- a. The measuring distance at 3 m shall be used for measurements at frequency 0.009MHz up to 1GHz, and above 1GHz.
- b. The EUT was placed on the top of a rotating table 0.8 m (above 1GHz is 1.5 m) above the ground at a 3 m anechoic chamber test site. The table was rotated 360 degree to determine the position of the highest radiation.
- c. The height of the equipment shall be 0.8 m(above 1GHz is 1.5 m); the height of the test antenna shall vary between 1 m to 4 m. Horizontal and vertical polarization of the antenna are set to make the measurement.
- d. The initial step in collecting conducted emission data is a spectrum analyzer peak detector mode pre-scanning the measurement frequency range. Significant peaks are then marked and QuasiPeak detector mode will be re-measured.
- e. If the Peak Mode measured value is compliance with and lower than Quasi Peak Mode Limit, the EUT shall be deemed to meet QP Limits and no additional QP Mode measurement was performed.
- f. For the actual test configuration, please refer to the related Item –EUT Test Photos.

Note:

Both horizontal and vertical antenna polarities were tested and performed pretest to three orthogonal axis. The worst case emissions were reported.

4.3 TEST SETUP

(A) Radiated Emission Test-Up Frequency Below 30MHz

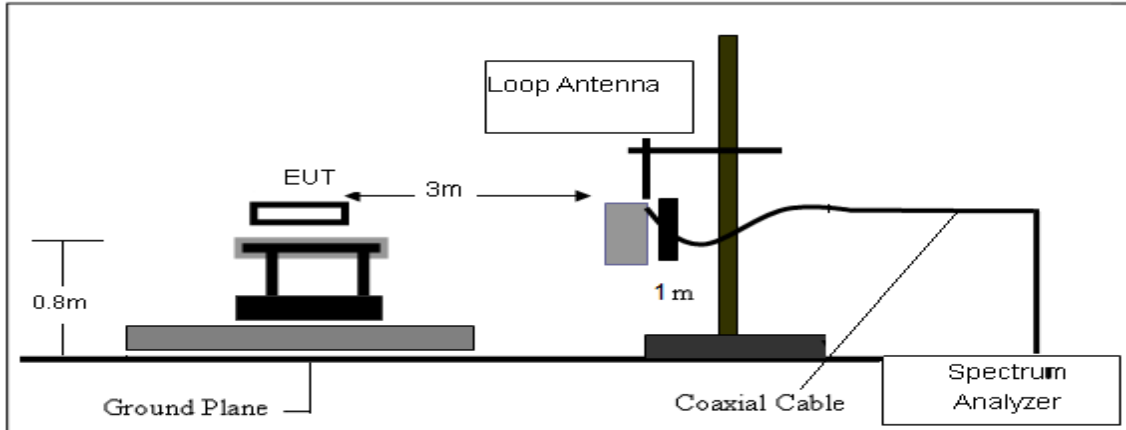

(B) Radiated Emission Test-Up Frequency 30MHz~1GHz

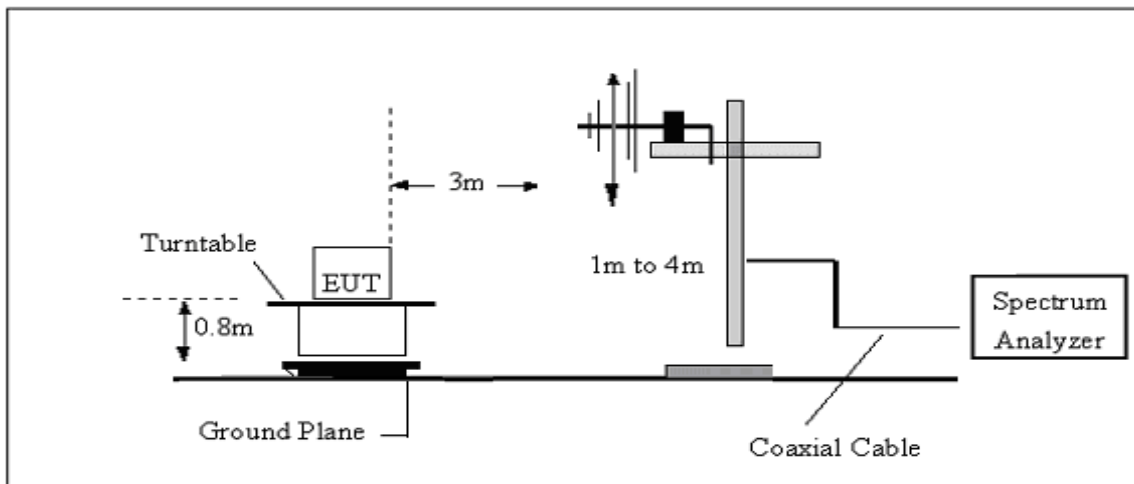

(C) Radiated Emission Test-Up Frequency Above 1GHz

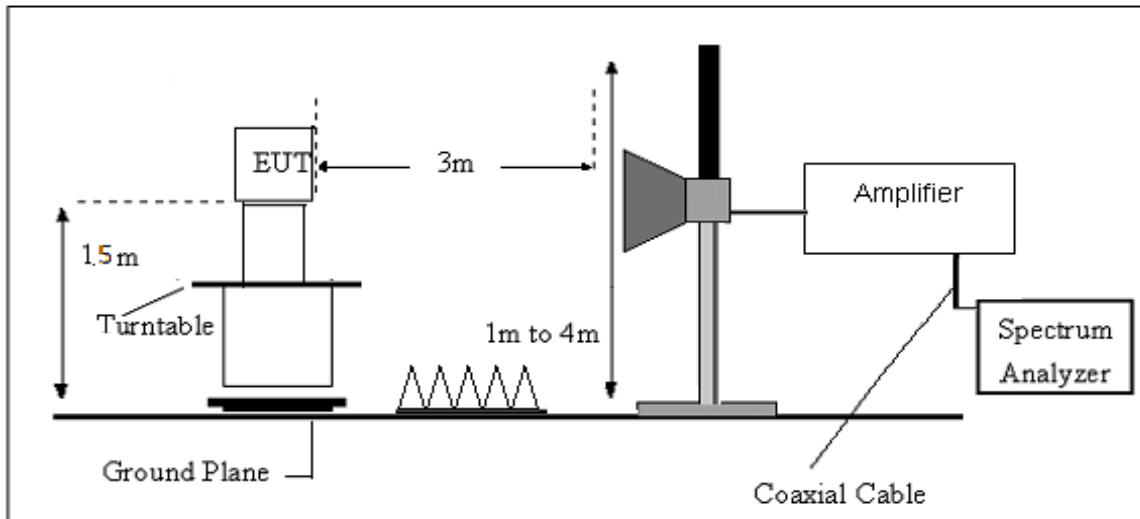

4.4 EUT OPERATING CONDITIONS

Please refer to section 3.4 of this report.



4.5 FIELD STRENGTH CALCULATION

The field strength is calculated by adding the Antenna Factor and Cable Factor and subtracting the Amplifier Gain and Duty Cycle Correction Factor (if any) from the measured reading. The basic equation with a sample calculation is as follows:

$$FS = RA + AF + CL - AG$$

Where

FS = Field Strength

CL = Cable Attenuation Factor (Cable Loss)

RA = Reading Amplitude

AG = Amplifier Gain

AF = Antenna Factor

For example

Frequency (MHz)	FS (dB μ V/m)	RA (dB μ V/m)	AF (dB)	CL (dB)	AG (dB)	Factor (dB)
300	40	58.1	12.2	1.6	31.9	-18.1

$$\text{Factor} = \text{AF} + \text{CL} - \text{AG}$$





4.6 TEST RESULTS

(Between 9KHz – 30 MHz)

Temperature:	23.1(C)	Relative Humidity:	60%RH
Test Voltage:	DC 3.7V	Polarization:	--
Test Mode:	TX Mode		

Freq. (MHz)	Reading (dBuV/m)	Limit (dBuV/m)	Margin (dB)	State P/F
--	--	--	--	PASS
--	--	--	--	PASS

Note:

The amplitude of spurious emissions which are attenuated by more than 20dB below the permissible value has no need to be reported.

Distance extrapolation factor = $40 \log(\text{specific distance}/\text{test distance})(\text{dB})$;

Limit line = specific limits(dBuv) + distance extrapolation factor.

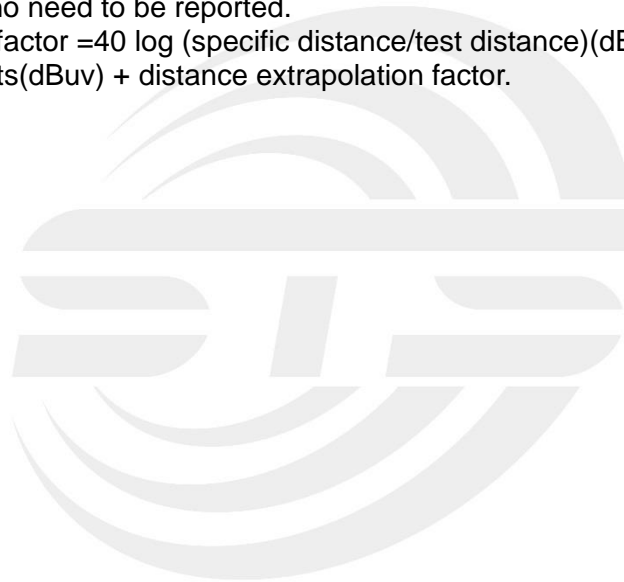



(30MHz -1000MHz)

1M PHY

Temperature:	23.1(C)	Relative Humidity:	60%RH
Test Voltage:	DC 3.7V	Phase:	Horizontal
Test Mode:	Mode 1/2/3 (Mode 3 worst mode)		

No.	Frequency (MHz)	Reading (dBuV)	Correct Factor(dB/m)	Result (dBuV/m)	Limit (dBuV/m)	Margin (dB)	Remark
1	156.1000	47.45	-18.66	28.79	43.50	-14.71	peak
2	383.0800	47.32	-12.06	35.26	46.00	-10.74	peak
3	479.1100	37.80	-8.68	29.12	46.00	-16.88	peak
4	733.2500	29.58	-2.35	27.23	46.00	-18.77	peak
5	840.9200	28.69	-0.38	28.31	46.00	-17.69	peak
6	979.6300	28.73	2.65	31.38	54.00	-22.62	peak

Remark:

- Margin = Result (Result =Reading + Factor) –Limit
- Factor= Antenna factor+Cable attenuation factor(cable loss)-Amplifier gain

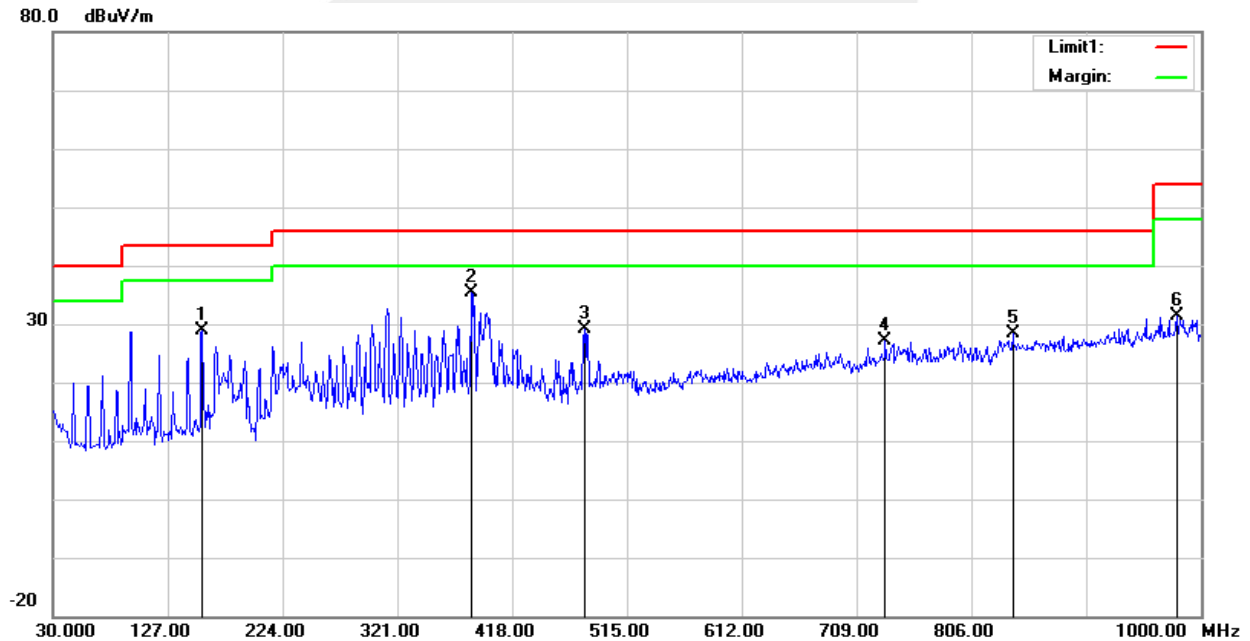



Temperature:	23.1(C)	Relative Humidity:	60%RH
Test Voltage:	DC 3.7V	Phase:	Vertical
Test Mode:	Mode 1/2/3 (Mode 3 worst mode)		

No.	Frequency (MHz)	Reading (dBUV)	Correct Factor(dB/m)	Result (dBUV/m)	Limit (dBUV/m)	Margin (dB)	Remark
1	60.0700	47.49	-25.86	21.63	40.00	-18.37	peak
2	399.5700	41.88	-11.16	30.72	46.00	-15.28	peak
3	631.4000	29.33	-5.01	24.32	46.00	-21.68	peak
4	733.2500	29.25	-2.35	26.90	46.00	-19.10	peak
5	903.0000	30.83	-0.37	30.46	46.00	-15.54	peak
6	984.4800	29.59	2.40	31.99	54.00	-22.01	peak

Remark:

- Margin = Result (Result =Reading + Factor)–Limit
- Factor= Antenna factor+Cable attenuation factor(cable loss)-Amplifier gain

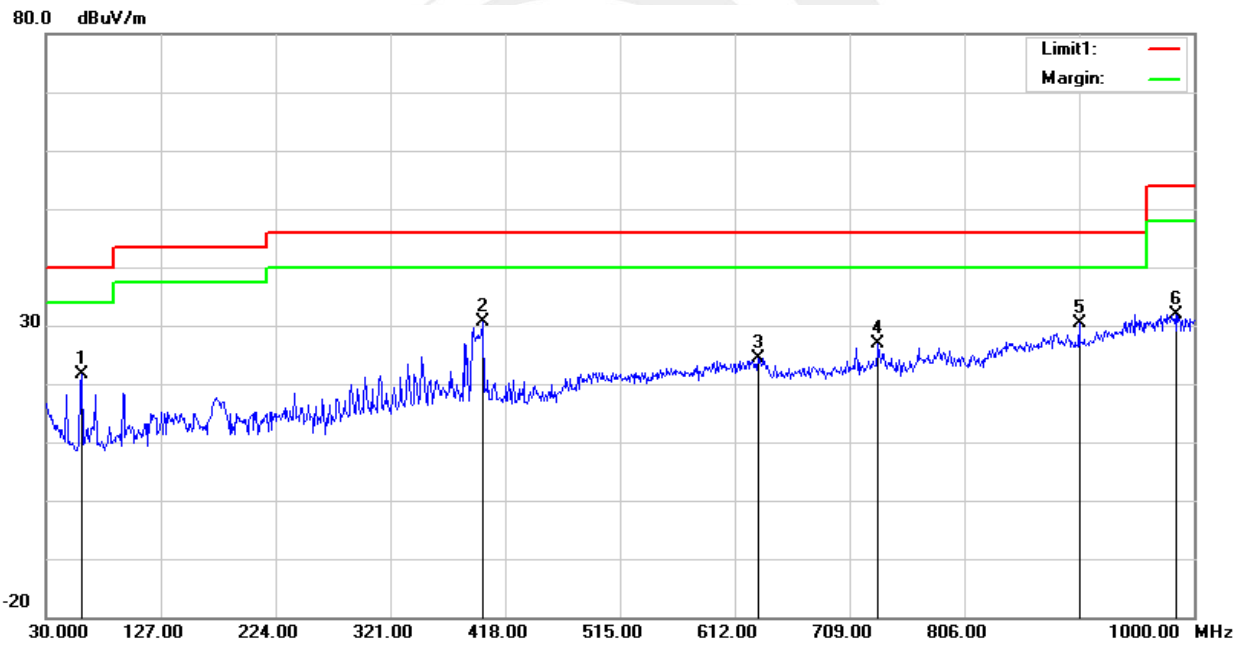



2M PHY

Temperature:	23.1(C)	Relative Humidity:	60%RH
Test Voltage:	DC 3.7V	Phase:	Horizontal
Test Mode:	Mode 1/2/3 (Mode 3 worst mode)		

No.	Frequency (MHz)	Reading (dBuV)	Correct Factor(dB/m)	Result (dBuV/m)	Limit (dBuV/m)	Margin (dB)	Remark
1	156.1000	48.22	-18.66	29.56	43.50	-13.94	peak
2	385.0200	47.18	-11.92	35.26	46.00	-10.74	peak
3	479.1100	38.67	-8.68	29.99	46.00	-16.01	peak
4	741.9800	29.20	-2.12	27.08	46.00	-18.92	peak
5	860.3200	30.61	-0.42	30.19	46.00	-15.81	peak
6	982.5400	28.97	2.52	31.49	54.00	-22.51	peak

Remark:

- Margin = Result (Result = Reading + Factor) - Limit
- Factor = Antenna factor + Cable attenuation factor (cable loss) - Amplifier gain

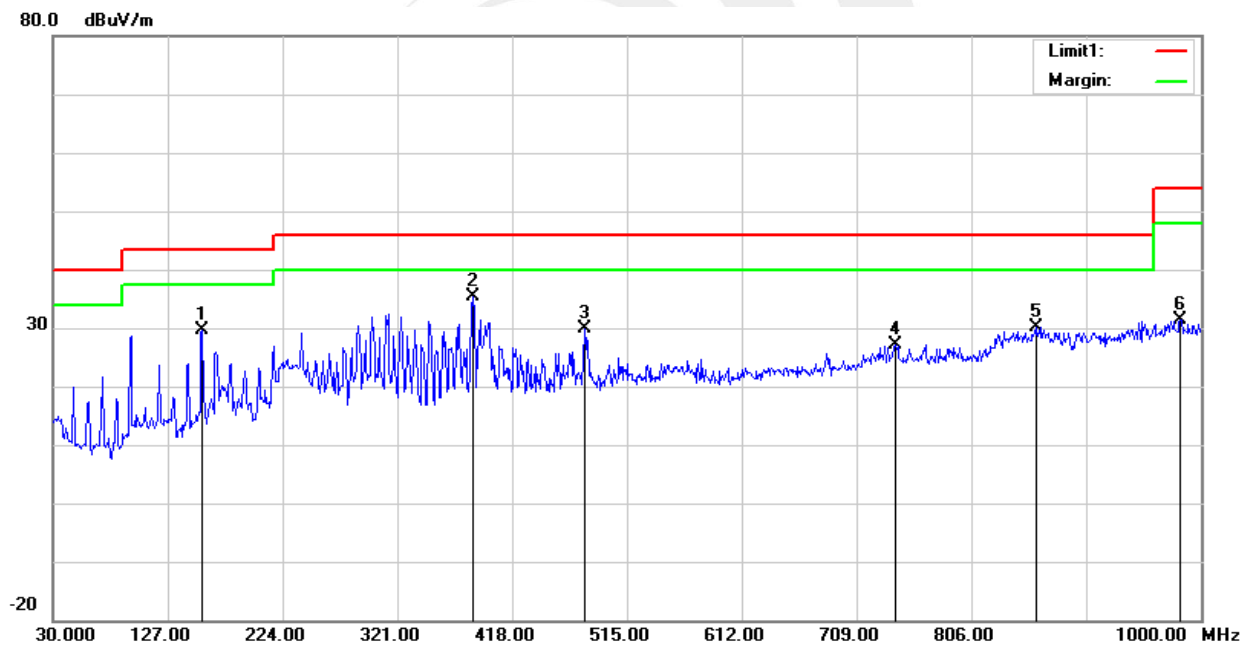



Temperature:	23.1(C)	Relative Humidity:	60%RH
Test Voltage:	DC 3.7V	Phase:	Vertical
Test Mode:	Mode 1/2/3 (Mode 3 worst mode)		

No.	Frequency (MHz)	Reading (dBuV)	Correct Factor(dB/m)	Result (dBuV/m)	Limit (dBuV/m)	Margin (dB)	Remark
1	156.1000	43.42	-18.66	24.76	43.50	-18.74	peak
2	347.1900	36.24	-13.16	23.08	46.00	-22.92	peak
3	398.6000	40.68	-11.20	29.48	46.00	-16.52	peak
4	569.3200	27.96	-5.59	22.37	46.00	-23.63	peak
5	732.2800	31.06	-2.39	28.67	46.00	-17.33	peak
6	982.5400	29.16	2.52	31.68	54.00	-22.32	peak

Remark:

- Margin = Result (Result =Reading + Factor)–Limit
- Factor= Antenna factor+Cable attenuation factor(cable loss)-Amplifier gain

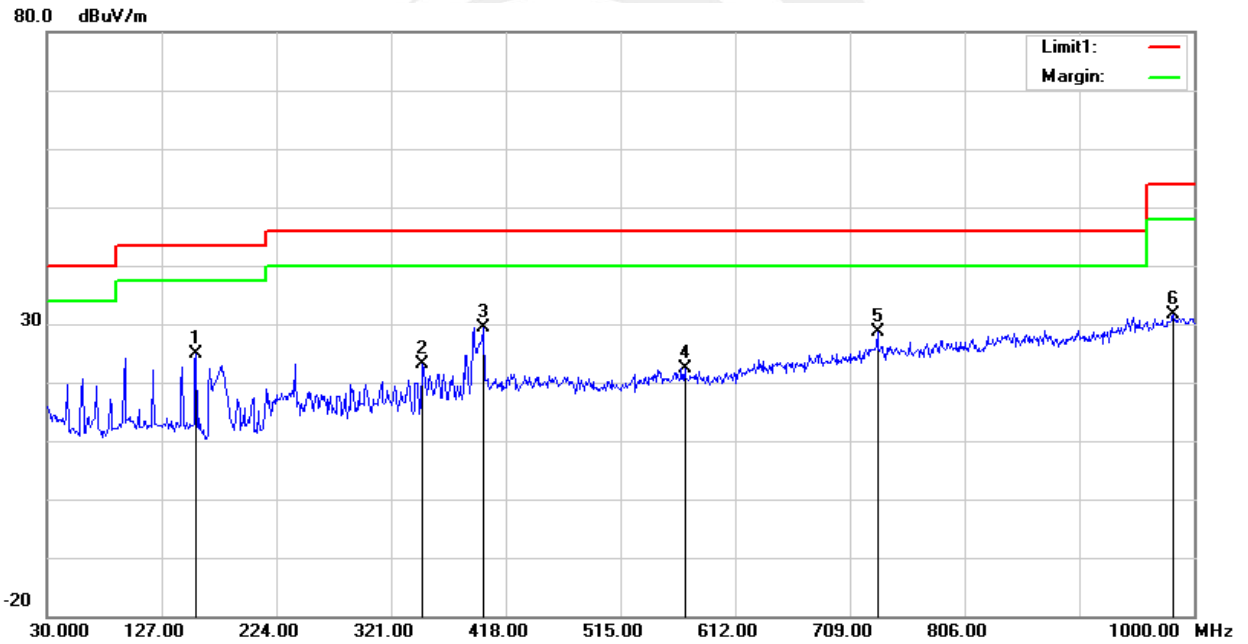



(1GHz-25GHz)Restricted band and Spurious emission Requirements

1M PHY
GFSK

Frequency (MHz)	Meter Reading (dBμV)	Amplifier (dB)	Loss (dB)	Antenna Factor (dB/m)	Corrected Factor (dB)	Emission Level (dBμV/m)	Limits (dBμV/m)	Margin (dB)	Detector Type	Comment
Low Channel (GFSK/2402 MHz)										
3264.77	62.00	44.70	6.70	28.20	-9.80	52.20	74.00	-21.80	PK	Vertical
3264.77	51.28	44.70	6.70	28.20	-9.80	41.48	54.00	-12.52	AV	Vertical
3264.71	60.99	44.70	6.70	28.20	-9.80	51.19	74.00	-22.81	PK	Horizontal
3264.71	50.12	44.70	6.70	28.20	-9.80	40.32	54.00	-13.68	AV	Horizontal
4804.45	58.47	44.20	9.04	31.60	-3.56	54.91	74.00	-19.09	PK	Vertical
4804.45	49.35	44.20	9.04	31.60	-3.56	45.79	54.00	-8.21	AV	Vertical
4804.43	59.38	44.20	9.04	31.60	-3.56	55.82	74.00	-18.18	PK	Horizontal
4804.43	49.80	44.20	9.04	31.60	-3.56	46.24	54.00	-7.76	AV	Horizontal
5359.85	49.10	44.20	9.86	32.00	-2.34	46.76	74.00	-27.24	PK	Vertical
5359.85	39.41	44.20	9.86	32.00	-2.34	37.07	54.00	-16.93	AV	Vertical
5359.80	47.57	44.20	9.86	32.00	-2.34	45.23	74.00	-28.77	PK	Horizontal
5359.80	38.05	44.20	9.86	32.00	-2.34	35.71	54.00	-18.29	AV	Horizontal
7205.81	53.68	43.50	11.40	35.50	3.40	57.08	74.00	-16.92	PK	Vertical
7205.81	43.71	43.50	11.40	35.50	3.40	47.11	54.00	-6.89	AV	Vertical
7205.96	54.18	43.50	11.40	35.50	3.40	57.58	74.00	-16.42	PK	Horizontal
7205.96	44.47	43.50	11.40	35.50	3.40	47.87	54.00	-6.13	AV	Horizontal
Middle Channel (GFSK/2440 MHz)										
3262.98	61.79	44.70	6.70	28.20	-9.80	51.99	74.00	-22.01	PK	Vertical
3262.98	51.53	44.70	6.70	28.20	-9.80	41.73	54.00	-12.27	AV	Vertical
3263.01	62.18	44.70	6.70	28.20	-9.80	52.38	74.00	-21.62	PK	Horizontal
3263.01	50.72	44.70	6.70	28.20	-9.80	40.92	54.00	-13.08	AV	Horizontal
4880.04	59.17	44.20	9.04	31.60	-3.56	55.61	74.00	-18.39	PK	Vertical
4880.04	49.44	44.20	9.04	31.60	-3.56	45.88	54.00	-8.12	AV	Vertical
4879.99	58.25	44.20	9.04	31.60	-3.56	54.69	74.00	-19.31	PK	Horizontal
4879.99	49.15	44.20	9.04	31.60	-3.56	45.59	54.00	-8.41	AV	Horizontal
5357.20	48.70	44.20	9.86	32.00	-2.34	46.36	74.00	-27.64	PK	Vertical
5357.20	39.97	44.20	9.86	32.00	-2.34	37.62	54.00	-16.38	AV	Vertical
5357.39	47.74	44.20	9.86	32.00	-2.34	45.40	74.00	-28.60	PK	Horizontal
5356.93	38.57	44.20	9.86	32.00	-2.34	36.23	54.00	-17.77	AV	Horizontal
7320.85	54.15	43.50	11.40	35.50	3.40	57.55	74.00	-16.45	PK	Vertical
7320.85	44.40	43.50	11.40	35.50	3.40	47.80	54.00	-6.20	AV	Vertical
7320.41	54.22	43.50	11.40	35.50	3.40	57.62	74.00	-16.38	PK	Horizontal
7320.41	44.14	43.50	11.40	35.50	3.40	47.54	54.00	-6.46	AV	Horizontal



High Channel (GFSK/2480 MHz)										
3264.66	61.43	44.70	6.70	28.20	-9.80	51.63	74.00	-22.37	PK	Vertical
3264.66	50.88	44.70	6.70	28.20	-9.80	41.08	54.00	-12.92	AV	Vertical
3264.78	60.92	44.70	6.70	28.20	-9.80	51.12	74.00	-22.88	PK	Horizontal
3264.78	50.78	44.70	6.70	28.20	-9.80	40.98	54.00	-13.02	AV	Horizontal
4960.50	59.20	44.20	9.04	31.60	-3.56	55.64	74.00	-18.36	PK	Vertical
4960.50	49.60	44.20	9.04	31.60	-3.56	46.04	54.00	-7.96	AV	Vertical
4960.55	58.55	44.20	9.04	31.60	-3.56	54.99	74.00	-19.01	PK	Horizontal
4960.55	50.56	44.20	9.04	31.60	-3.56	47.00	54.00	-7.00	AV	Horizontal
5359.68	48.02	44.20	9.86	32.00	-2.34	45.68	74.00	-28.32	PK	Vertical
5359.68	40.37	44.20	9.86	32.00	-2.34	38.02	54.00	-15.98	AV	Vertical
5359.79	47.37	44.20	9.86	32.00	-2.34	45.03	74.00	-28.97	PK	Horizontal
5359.79	38.75	44.20	9.86	32.00	-2.34	36.41	54.00	-17.59	AV	Horizontal
7439.97	54.67	43.50	11.40	35.50	3.40	58.07	74.00	-15.93	PK	Vertical
7439.97	44.42	43.50	11.40	35.50	3.40	47.82	54.00	-6.18	AV	Vertical
7439.76	53.62	43.50	11.40	35.50	3.40	57.02	74.00	-16.98	PK	Horizontal
7439.76	44.67	43.50	11.40	35.50	3.40	48.07	54.00	-5.93	AV	Horizontal

Note:

1) Factor = Antenna Factor + Cable Loss – Pre-amplifier.

Emission Level = Reading + Factor.

2) The frequency emission of peak points that did not show above the forms are at least 20dB below the limit, the frequency emission is mainly from the environment noise.

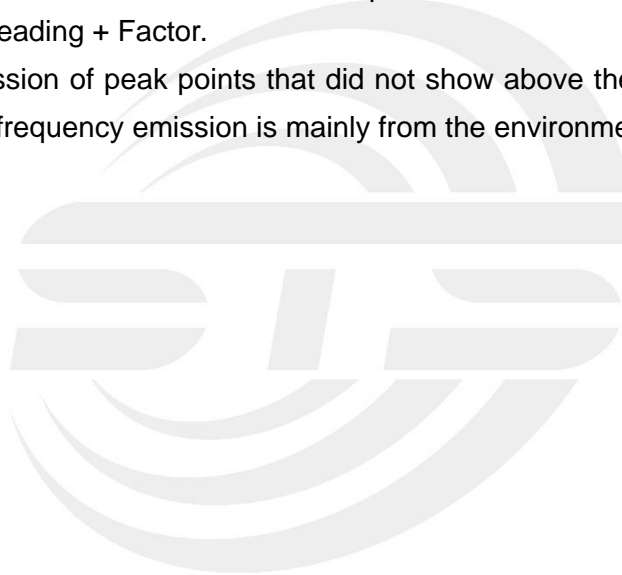



2M PHY GFSK

Frequency (MHz)	Meter Reading (dBμV)	Amplifier (dB)	Loss (dB)	Antenna Factor (dB/m)	Corrected Factor (dB)	Emission Level (dBμV/m)	Limits (dBμV/m)	Margin (dB)	Detector Type	Comment
Low Channel (GFSK/2402 MHz)										
3264.76	60.94	44.70	6.70	28.20	-9.80	51.14	74.00	-22.86	PK	Vertical
3264.76	51.67	44.70	6.70	28.20	-9.80	41.87	54.00	-12.13	AV	Vertical
3264.78	61.95	44.70	6.70	28.20	-9.80	52.15	74.00	-21.85	PK	Horizontal
3264.78	50.03	44.70	6.70	28.20	-9.80	40.23	54.00	-13.77	AV	Horizontal
4804.37	58.16	44.20	9.04	31.60	-3.56	54.60	74.00	-19.40	PK	Vertical
4804.37	49.34	44.20	9.04	31.60	-3.56	45.78	54.00	-8.22	AV	Vertical
4804.34	58.23	44.20	9.04	31.60	-3.56	54.67	74.00	-19.33	PK	Horizontal
4804.34	50.37	44.20	9.04	31.60	-3.56	46.81	54.00	-7.19	AV	Horizontal
5359.64	49.17	44.20	9.86	32.00	-2.34	46.82	74.00	-27.18	PK	Vertical
5359.64	40.28	44.20	9.86	32.00	-2.34	37.94	54.00	-16.06	AV	Vertical
5359.74	47.54	44.20	9.86	32.00	-2.34	45.19	74.00	-28.81	PK	Horizontal
5359.74	38.40	44.20	9.86	32.00	-2.34	36.05	54.00	-17.95	AV	Horizontal
7205.79	54.62	43.50	11.40	35.50	3.40	58.02	74.00	-15.98	PK	Vertical
7205.79	44.17	43.50	11.40	35.50	3.40	47.57	54.00	-6.43	AV	Vertical
7205.73	53.93	43.50	11.40	35.50	3.40	57.33	74.00	-16.67	PK	Horizontal
7205.73	43.71	43.50	11.40	35.50	3.40	47.11	54.00	-6.89	AV	Horizontal
Middle Channel (GFSK/2440 MHz)										
3262.95	61.53	44.70	6.70	28.20	-9.80	51.73	74.00	-22.27	PK	Vertical
3262.95	51.49	44.70	6.70	28.20	-9.80	41.69	54.00	-12.31	AV	Vertical
3263.22	61.80	44.70	6.70	28.20	-9.80	52.00	74.00	-22.00	PK	Horizontal
3263.22	51.21	44.70	6.70	28.20	-9.80	41.41	54.00	-12.59	AV	Horizontal
4879.85	59.25	44.20	9.04	31.60	-3.56	55.69	74.00	-18.31	PK	Vertical
4879.85	50.05	44.20	9.04	31.60	-3.56	46.49	54.00	-7.51	AV	Vertical
4880.15	58.84	44.20	9.04	31.60	-3.56	55.28	74.00	-18.72	PK	Horizontal
4880.15	49.45	44.20	9.04	31.60	-3.56	45.89	54.00	-8.11	AV	Horizontal
5357.32	48.65	44.20	9.86	32.00	-2.34	46.31	74.00	-27.69	PK	Vertical
5357.32	40.26	44.20	9.86	32.00	-2.34	37.91	54.00	-16.09	AV	Vertical
5357.39	48.20	44.20	9.86	32.00	-2.34	45.86	74.00	-28.14	PK	Horizontal
5357.12	38.66	44.20	9.86	32.00	-2.34	36.32	54.00	-17.68	AV	Horizontal
7320.85	54.59	43.50	11.40	35.50	3.40	57.99	74.00	-16.01	PK	Vertical
7320.85	44.36	43.50	11.40	35.50	3.40	47.76	54.00	-6.24	AV	Vertical
7320.51	54.65	43.50	11.40	35.50	3.40	58.05	74.00	-15.95	PK	Horizontal
7320.51	43.81	43.50	11.40	35.50	3.40	47.21	54.00	-6.79	AV	Horizontal



High Channel (GFSK/2480 MHz)										
3264.70	61.84	44.70	6.70	28.20	-9.80	52.04	74.00	-21.96	PK	Vertical
3264.70	50.92	44.70	6.70	28.20	-9.80	41.12	54.00	-12.88	AV	Vertical
3264.81	60.97	44.70	6.70	28.20	-9.80	51.17	74.00	-22.83	PK	Horizontal
3264.81	51.18	44.70	6.70	28.20	-9.80	41.38	54.00	-12.62	AV	Horizontal
4960.54	58.89	44.20	9.04	31.60	-3.56	55.33	74.00	-18.67	PK	Vertical
4960.54	49.12	44.20	9.04	31.60	-3.56	45.56	54.00	-8.44	AV	Vertical
4960.51	58.56	44.20	9.04	31.60	-3.56	55.00	74.00	-19.00	PK	Horizontal
4960.51	50.43	44.20	9.04	31.60	-3.56	46.87	54.00	-7.13	AV	Horizontal
5359.78	48.88	44.20	9.86	32.00	-2.34	46.54	74.00	-27.46	PK	Vertical
5359.78	38.98	44.20	9.86	32.00	-2.34	36.63	54.00	-17.37	AV	Vertical
5359.77	47.66	44.20	9.86	32.00	-2.34	45.32	74.00	-28.68	PK	Horizontal
5359.77	38.77	44.20	9.86	32.00	-2.34	36.42	54.00	-17.58	AV	Horizontal
7439.90	53.82	43.50	11.40	35.50	3.40	57.22	74.00	-16.78	PK	Vertical
7439.90	43.84	43.50	11.40	35.50	3.40	47.24	54.00	-6.76	AV	Vertical
7439.79	54.87	43.50	11.40	35.50	3.40	58.27	74.00	-15.73	PK	Horizontal
7439.79	44.33	43.50	11.40	35.50	3.40	47.73	54.00	-6.27	AV	Horizontal

Note:

1) Factor = Antenna Factor + Cable Loss – Pre-amplifier.

Emission Level = Reading + Factor.

2) The frequency emission of peak points that did not show above the forms are at least 20dB below the limit, the frequency emission is mainly from the environment noise.

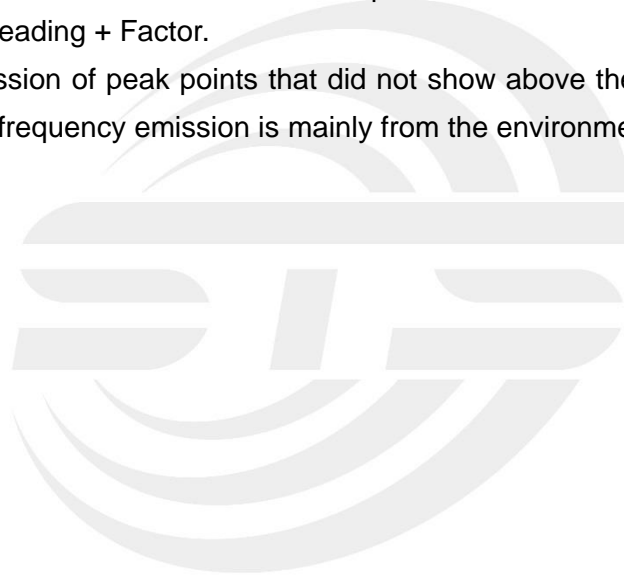



4.6 TEST RESULTS (Restricted Bands Requirements)

1M PHY
GFSK-Low
Horizontal

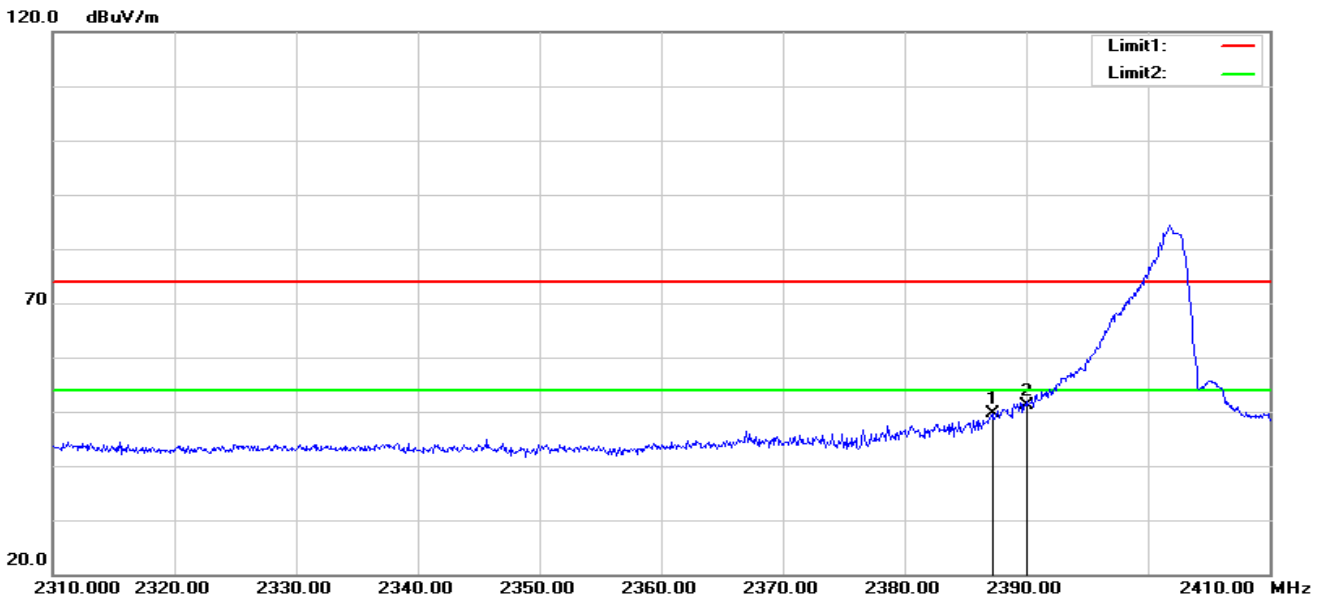

No.	Frequency (MHz)	Reading (dBuV)	Correct Factor(dB/m)	Result (dBuV/m)	Limit (dBuV/m)	Margin (dB)	Remark
1	2387.300	45.36	4.30	49.66	74.00	-24.34	peak
2	2390.000	46.77	4.34	51.11	74.00	-22.89	peak

Vertical

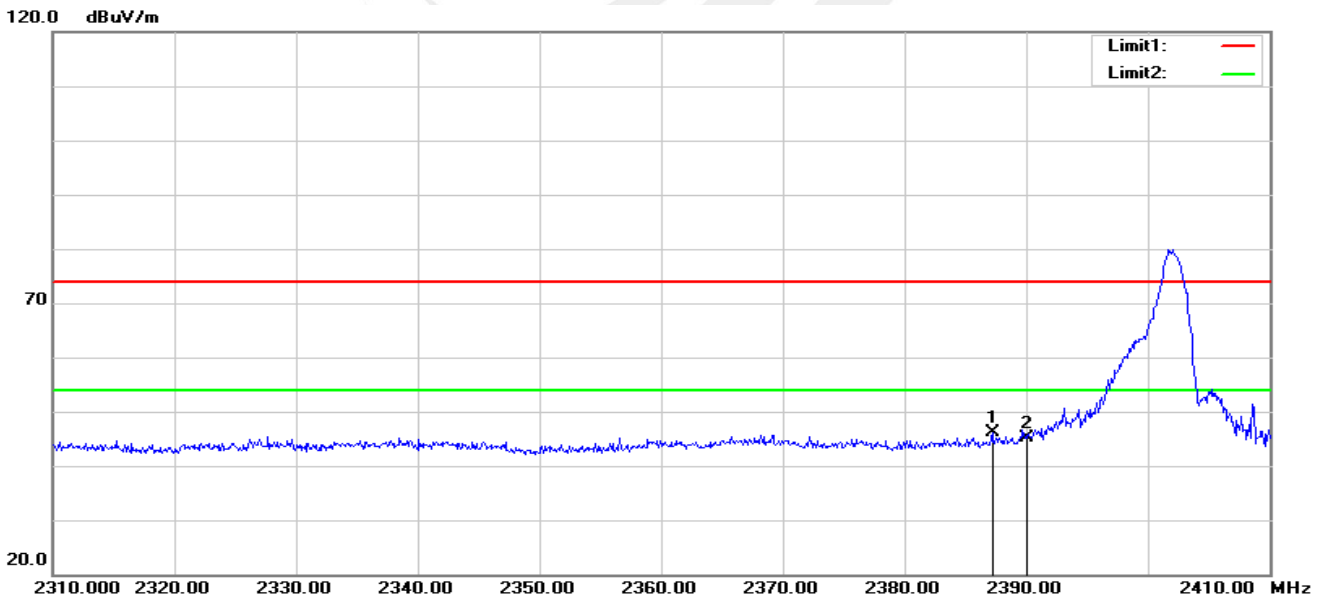

No.	Frequency (MHz)	Reading (dBuV)	Correct Factor(dB/m)	Result (dBuV/m)	Limit (dBuV/m)	Margin (dB)	Remark
1	2387.200	41.87	4.30	46.17	74.00	-27.83	peak
2	2390.000	40.90	4.34	45.24	74.00	-28.76	peak



GFSK-High
Horizontal

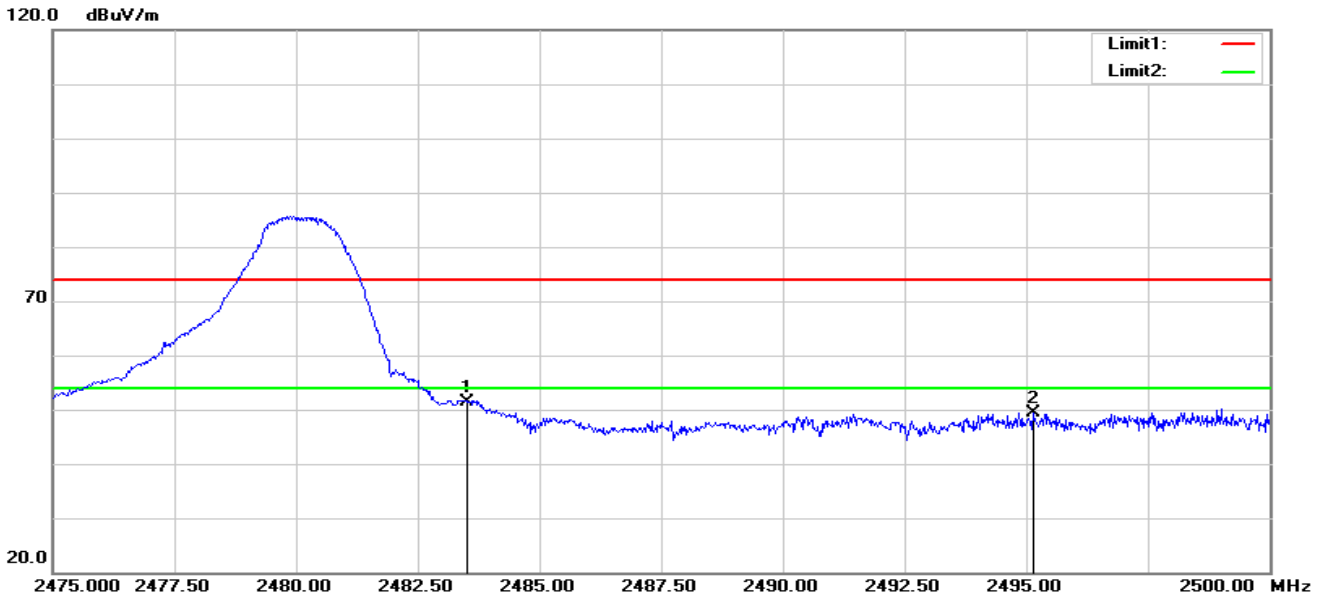

No.	Frequency (MHz)	Reading (dBuV)	Correct Factor(dB/m)	Result (dBuV/m)	Limit (dBuV/m)	Margin (dB)	Remark
1	2483.500	46.86	4.60	51.46	74.00	-22.54	peak
2	2495.150	44.81	4.63	49.44	74.00	-24.56	peak

Vertical

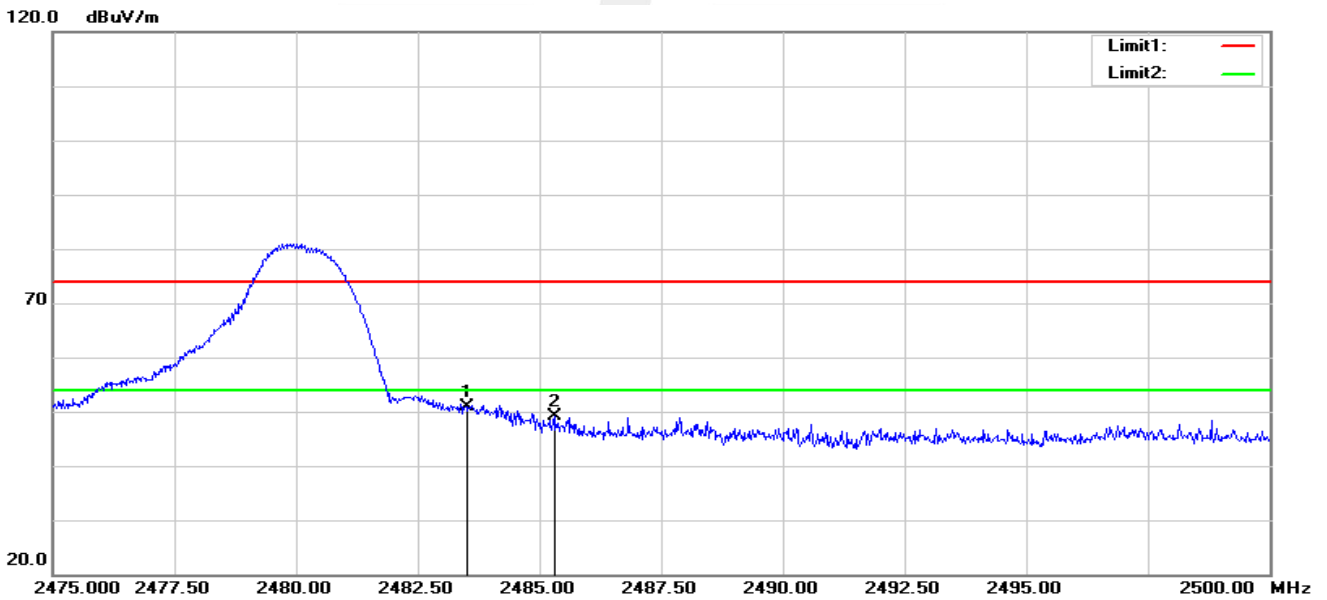

No.	Frequency (MHz)	Reading (dBuV)	Correct Factor(dB/m)	Result (dBuV/m)	Limit (dBuV/m)	Margin (dB)	Remark
1	2483.500	46.38	4.60	50.98	74.00	-23.02	peak
2	2485.300	44.41	4.61	49.02	74.00	-24.98	peak



2M PHY
GFSK-Low
Horizontal

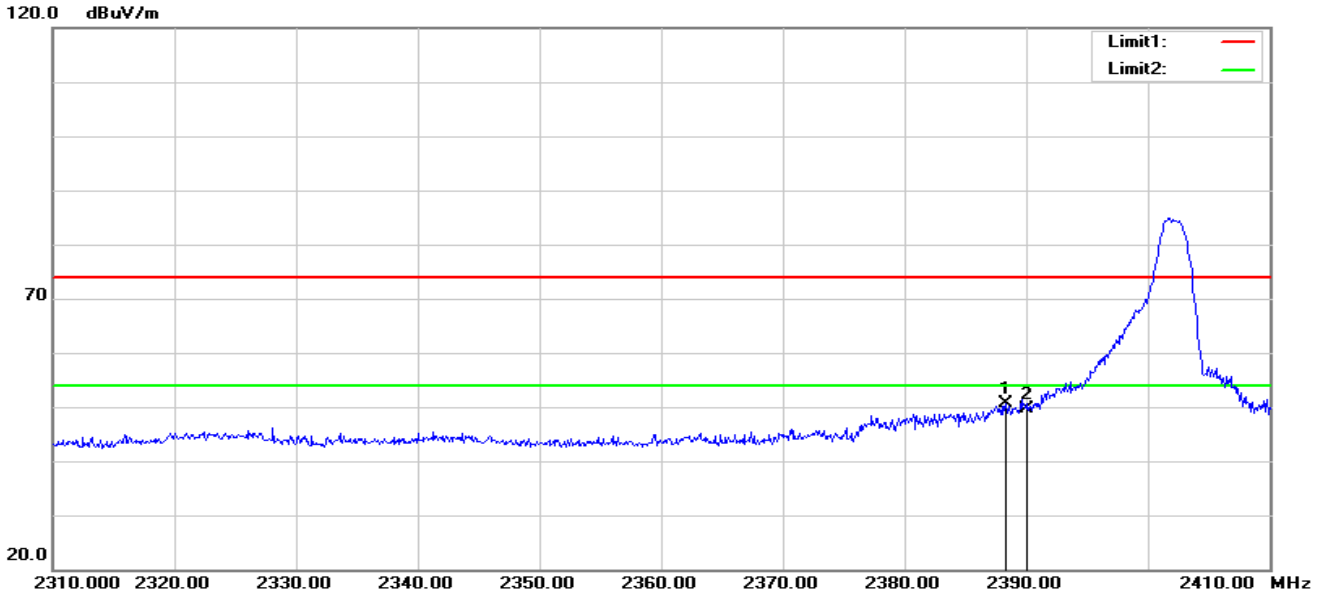

No.	Frequency (MHz)	Reading (dBuV)	Correct Factor(dB/m)	Result (dBuV/m)	Limit (dBuV/m)	Margin (dB)	Remark
1	2388.300	46.43	4.31	50.74	74.00	-23.26	peak
2	2390.000	45.18	4.34	49.52	74.00	-24.48	peak

Vertical

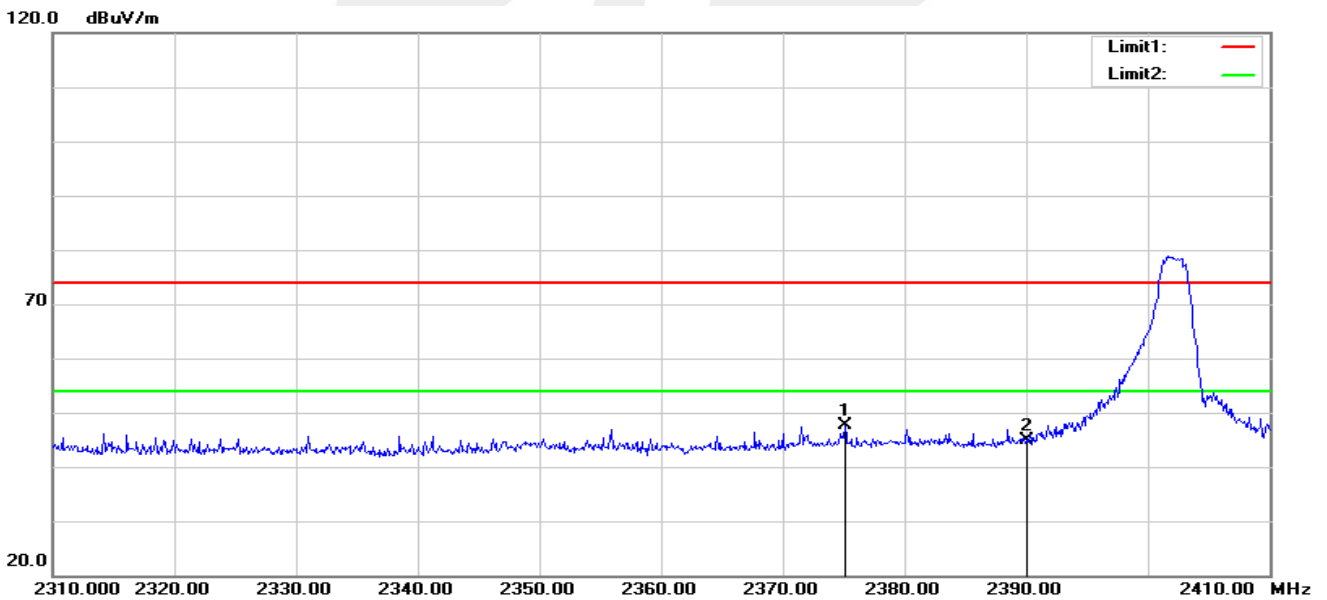

No.	Frequency (MHz)	Reading (dBuV)	Correct Factor(dB/m)	Result (dBuV/m)	Limit (dBuV/m)	Margin (dB)	Remark
1	2375.100	43.56	4.12	47.68	74.00	-26.32	peak
2	2390.000	40.59	4.34	44.93	74.00	-29.07	peak



GFSK-High
Horizontal

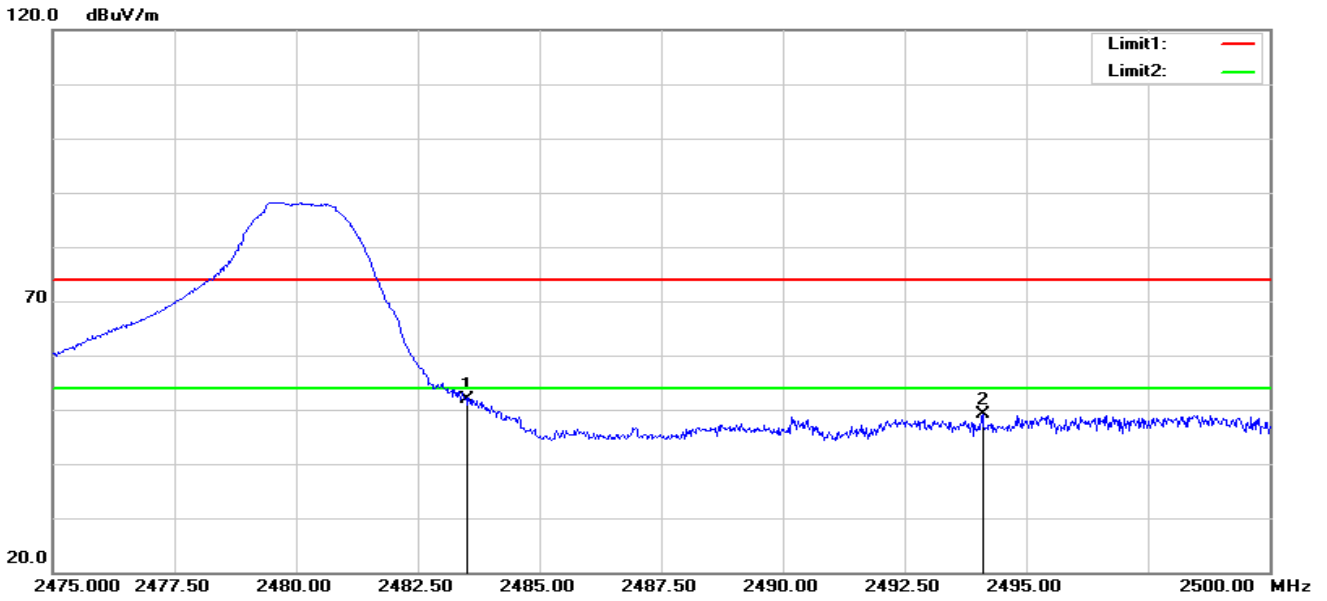

No.	Frequency (MHz)	Reading (dBuV)	Correct Factor(dB/m)	Result (dBuV/m)	Limit (dBuV/m)	Margin (dB)	Remark
1	2483.500	47.40	4.60	52.00	74.00	-22.00	peak
2	2494.100	44.61	4.63	49.24	74.00	-24.76	peak

Vertical

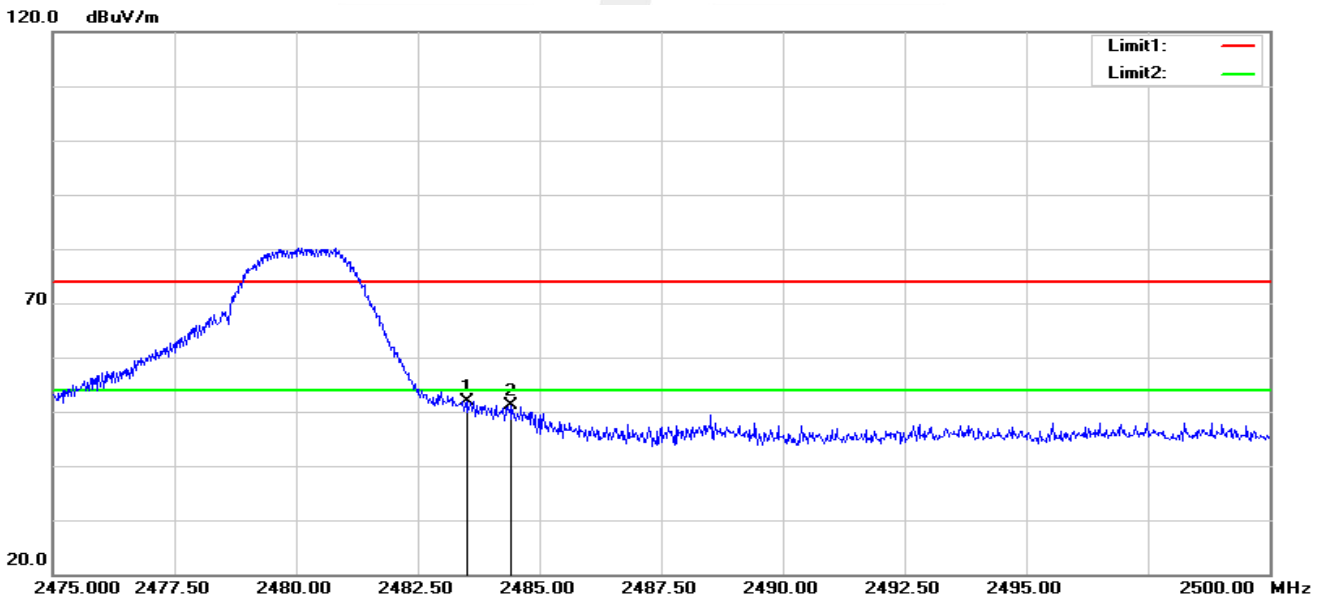

No.	Frequency (MHz)	Reading (dBuV)	Correct Factor(dB/m)	Result (dBuV/m)	Limit (dBuV/m)	Margin (dB)	Remark
1	2483.500	47.19	4.60	51.79	74.00	-22.21	peak
2	2484.400	46.59	4.61	51.20	74.00	-22.80	peak

5. CONDUCTED SPURIOUS & BAND EDGE EMISSION

5.1 LIMIT

According to FCC section 15.247(d), in any 100kHz bandwidth outside the frequency band in which the spread spectrum or digitally modulated intentional radiator is operating, the radio frequency power that is produced by the intentional radiator shall be at least 20dB below that in the 100kHz bandwidth within the band that contains the highest level of the desired power, based on either an RF conducted or a radiated measurement.

5.2 TEST PROCEDURE

Spectrum Parameter	Setting
Detector	Peak
Start/Stop Frequency	30 MHz to 10th carrier harmonic
RB / VB (emission in restricted band)	100 KHz/300 KHz
Trace-Mode:	Max hold

For Band edge

Spectrum Parameter	Setting
Detector	Peak
Start/Stop Frequency	Lower Band Edge: 2300 – 2407 MHz Upper Band Edge: 2475 – 2500 MHz
RB / VB (emission in restricted band)	100 KHz/300 KHz
Trace-Mode:	Max hold

5.3 TEST SETUP



The EUT which is powered by the Battery, is connected to the Spectrum Analyzer; the RF load attached to the EUT antenna terminal is 50 Ohm; the path loss as the factor is calibrated to correct the reading. Make the measurement with the spectrum analyzer's resolution bandwidth(RBW) = 100 kHz. In order to make an accurate measurement, set the span greater than RBW.

5.4 EUT OPERATION CONDITIONS

Please refer to section 3.4 of this report.



5.5 TEST RESULTS

Temperature:	25 °C	Relative Humidity:	50%
Test Voltage:	DC 3.7V	Test Mode:	TX Mode /CH00, CH19, CH39

1M PHY
00 CH

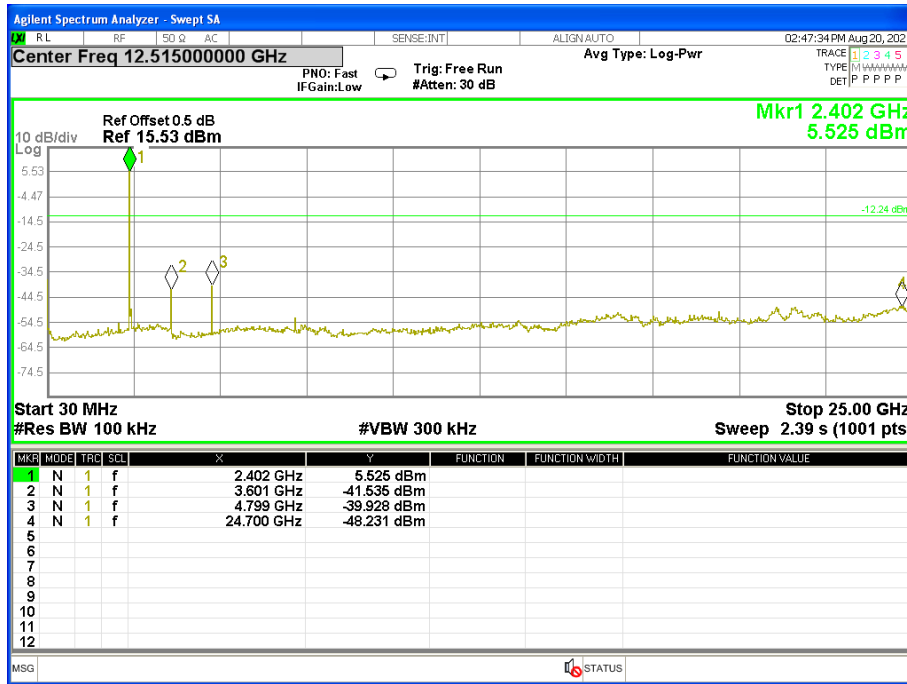



19 CH

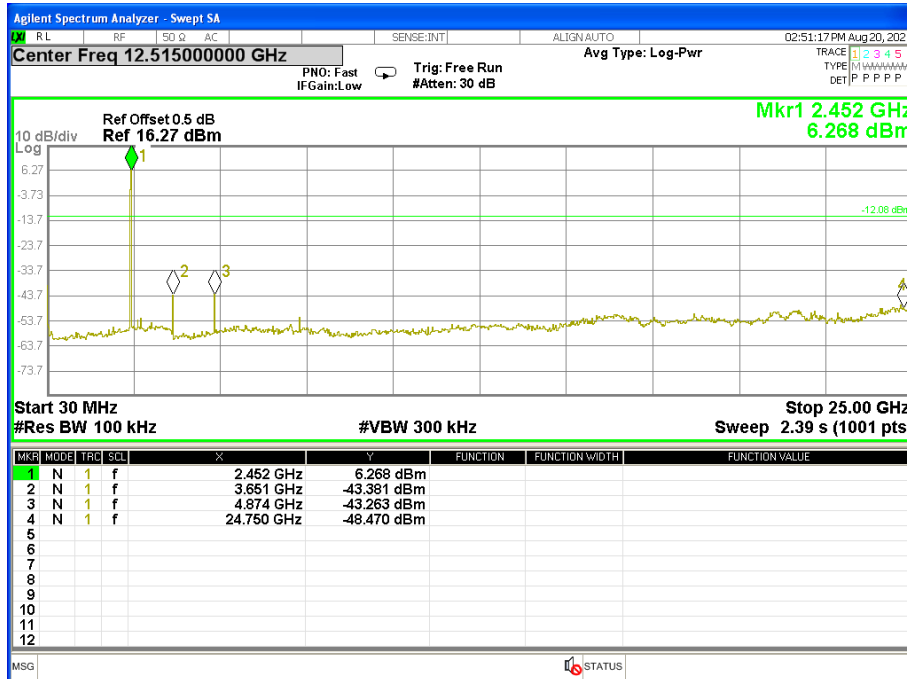

39 CH

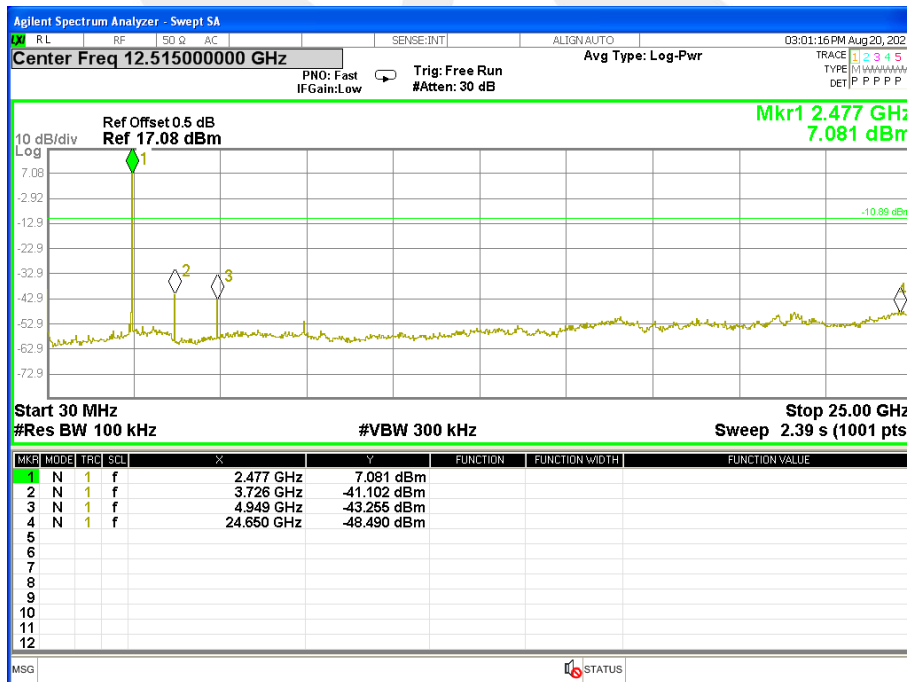



For Band edge(it's also the reference level for conducted spurious emission)

00 CH

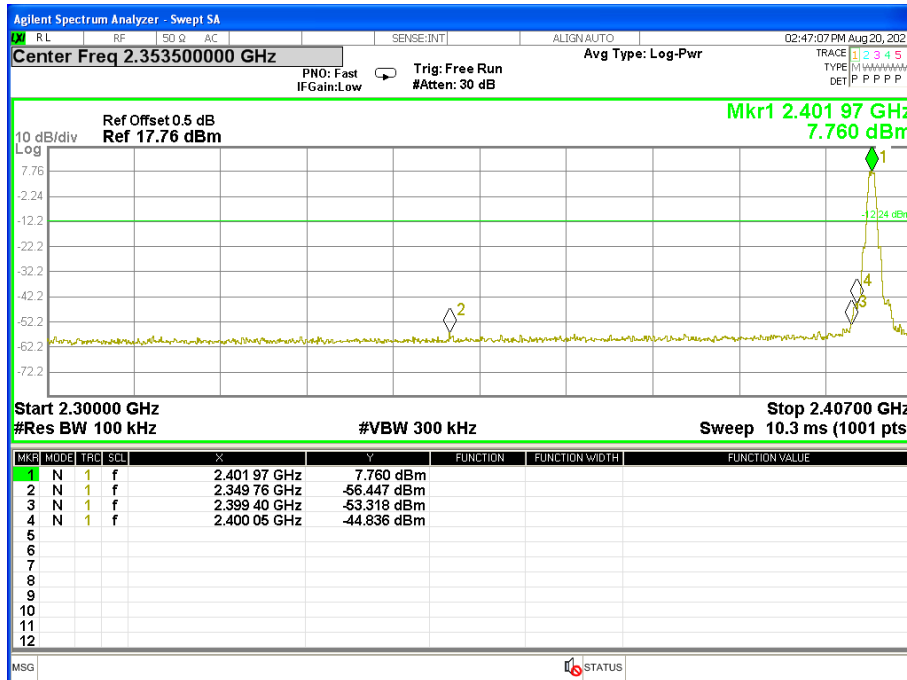

19 CH

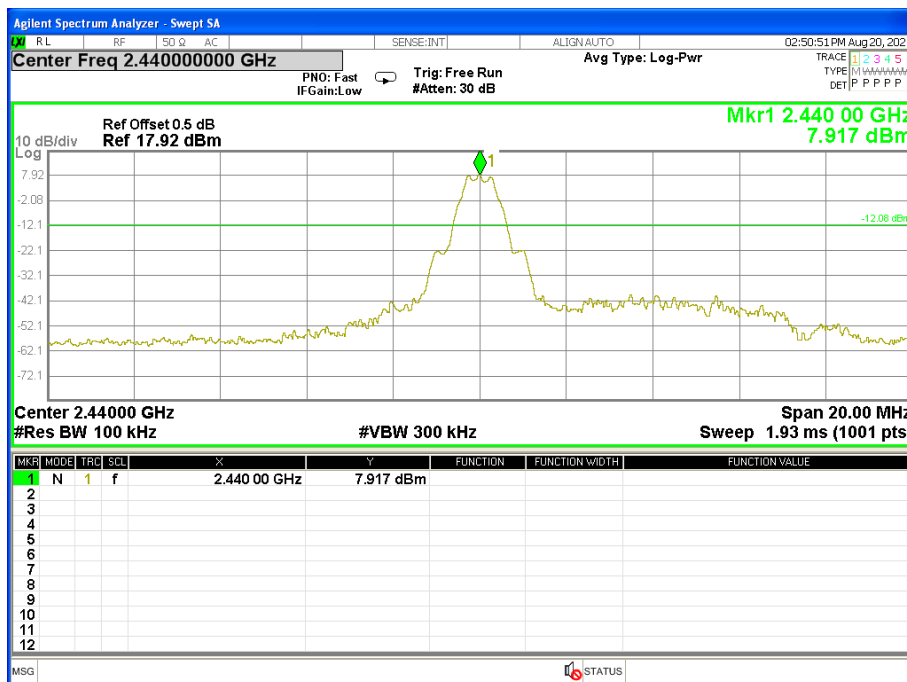



39 CH

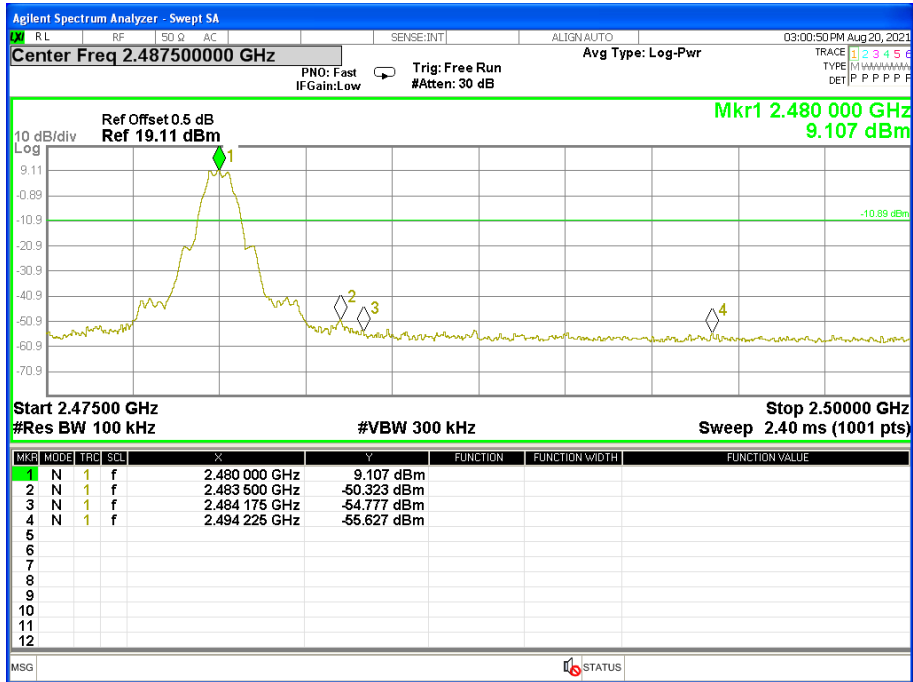



2M PHY
00 CH

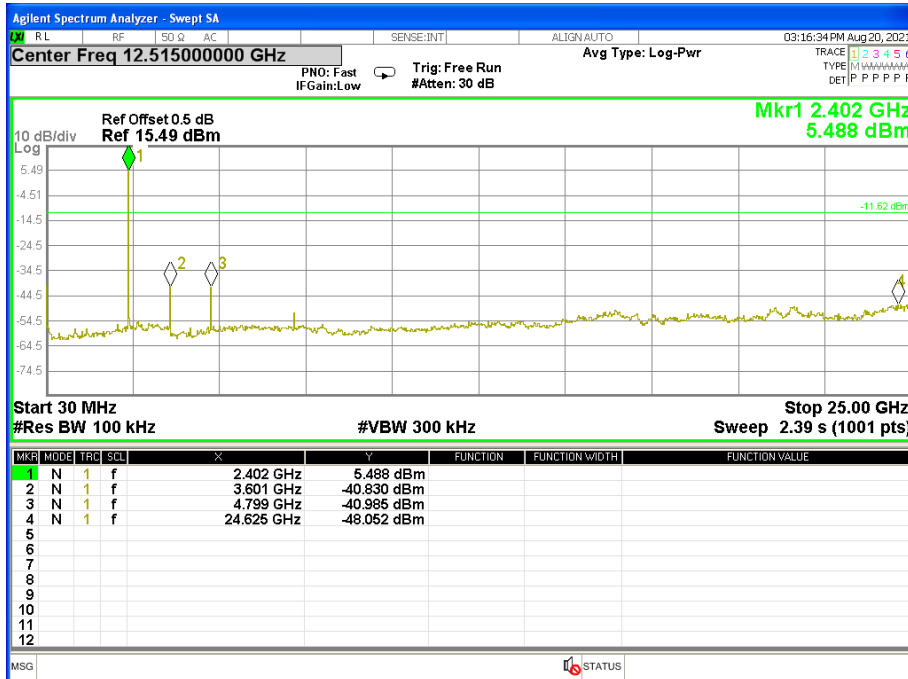



19 CH

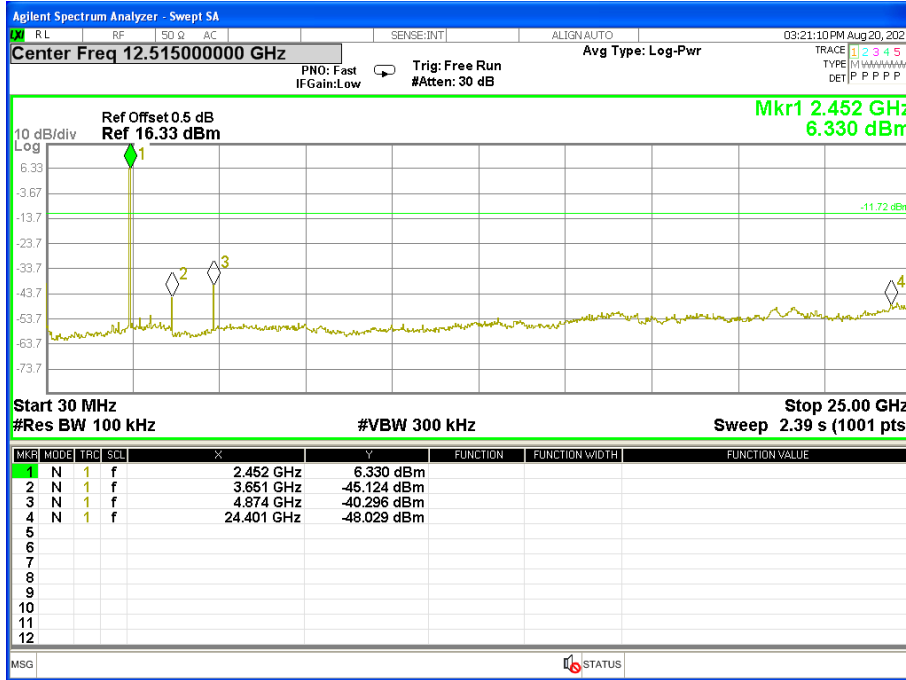

39 CH

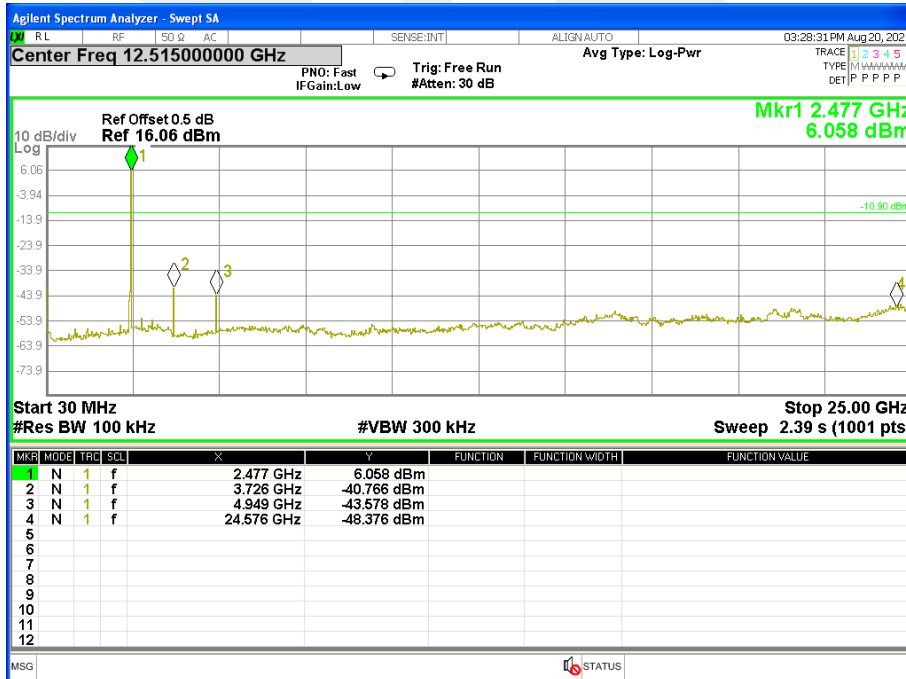



For Band edge(it's also the reference level for conducted spurious emission)

00 CH

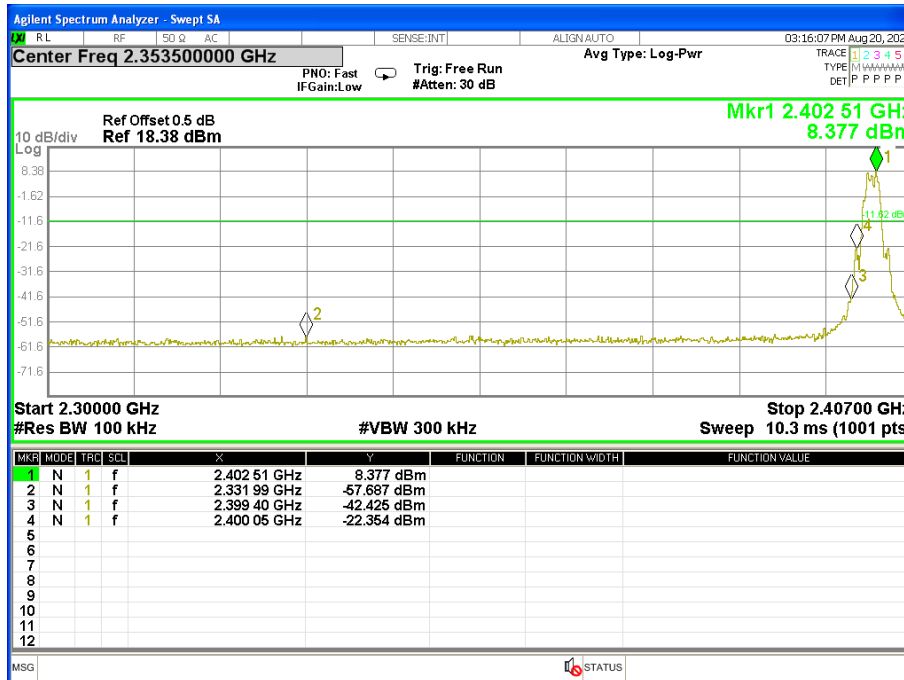

19 CH

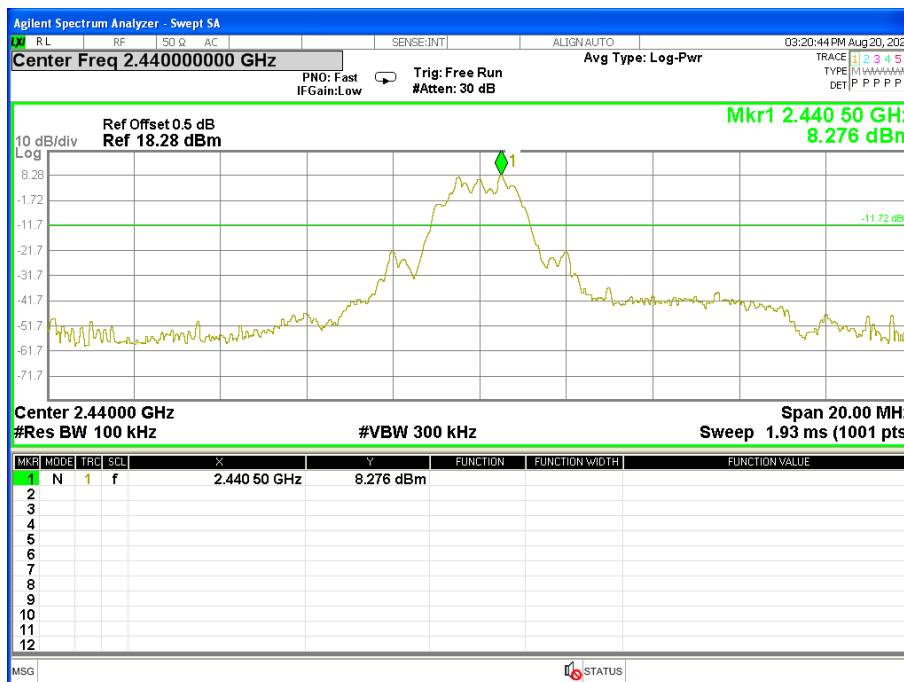



39 CH

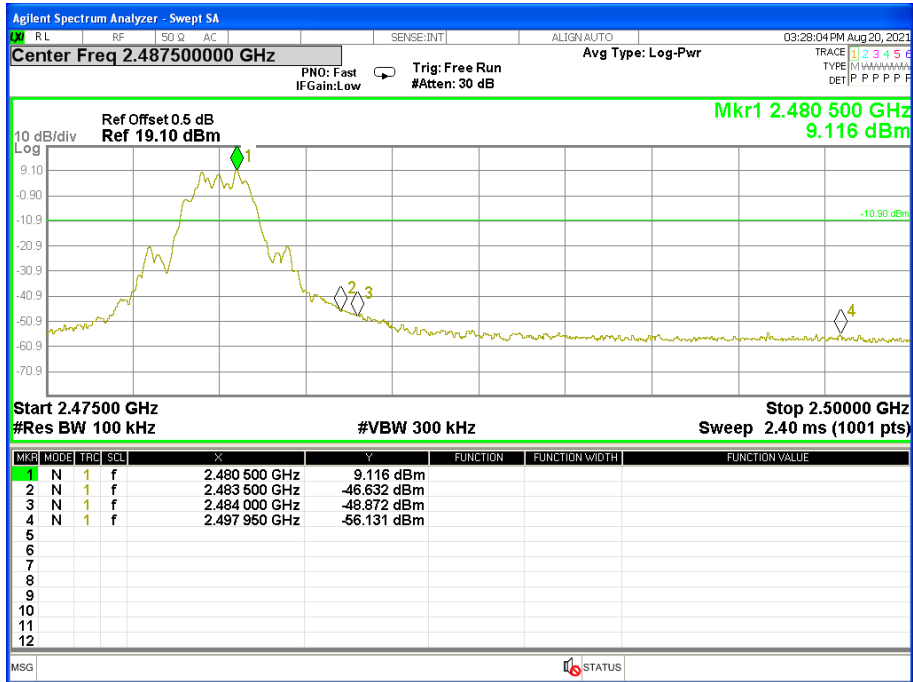

6. POWER SPECTRAL DENSITY TEST

6.1 LIMIT

FCC Part 15.247, Subpart C				
Section	Test Item	Limit	Frequency Range (MHz)	Result
15.247(e)	Power Spectral Density	≤ 8 dBm (RBW ≥ 3 KHz)	2400-2483.5	PASS

6.2 TEST PROCEDURE

1. Set analyzer center frequency to DTS channel center frequency.
2. Set the span to 1.5 times the DTS channel bandwidth.
3. Set the RBW to: $100 \text{ kHz} \geq \text{RBW} \geq 3 \text{ kHz}$.
4. Set the VBW $\geq 3 \times \text{RBW}$.
5. Detector = peak.
6. Sweep time = auto couple.
7. Trace mode = max hold.
8. Allow trace to fully stabilize.
9. Use the peak marker function to determine the maximum amplitude level.
10. If measured value exceeds limit, reduce RBW (no less than 3 kHz) and repeat.

6.3 TEST SETUP



6.4 EUT OPERATION CONDITIONS

Please refer to section 3.4 of this report.



6.5 TEST RESULTS

Temperature:	25 °C	Relative Humidity:	60%
Test Voltage:	DC 3.7V	Test Mode:	TX Mode /CH00, CH19, CH39

1M PHY

Frequency	Power Density	Limit (dBm/3KHz)	Result
	(dBm/3kHz)		
2402 MHz	-5.481	≤8	PASS
2440 MHz	-5.514	≤8	PASS
2480 MHz	-4.160	≤8	PASS

TX CH00

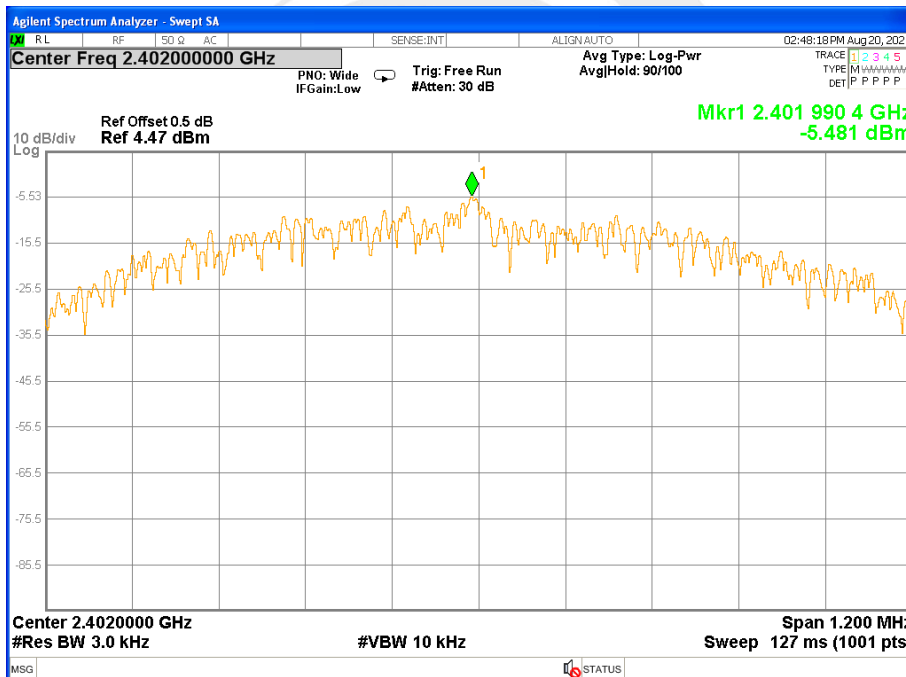



TX CH19

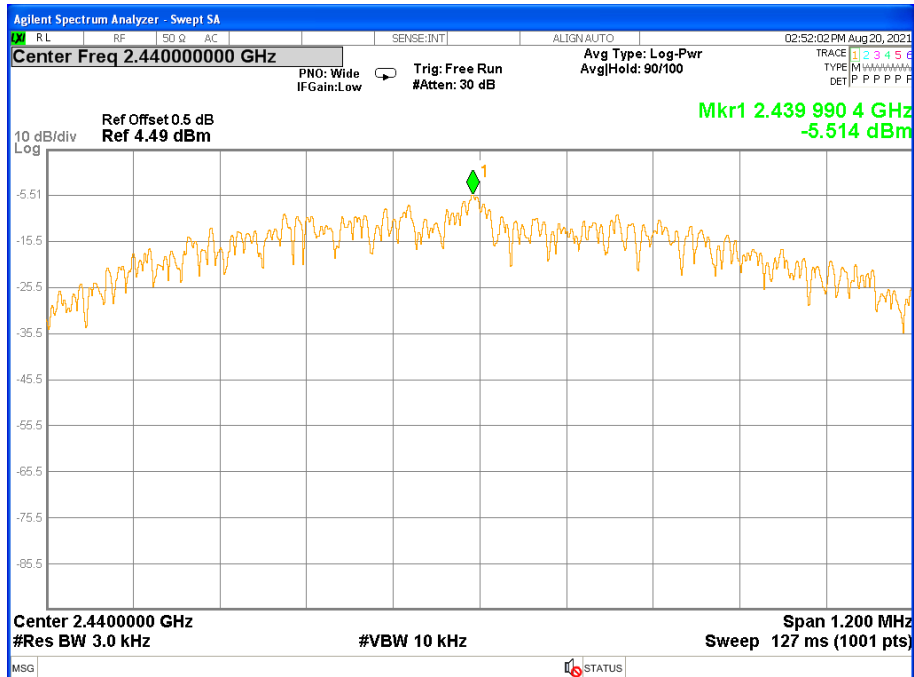

TX CH39

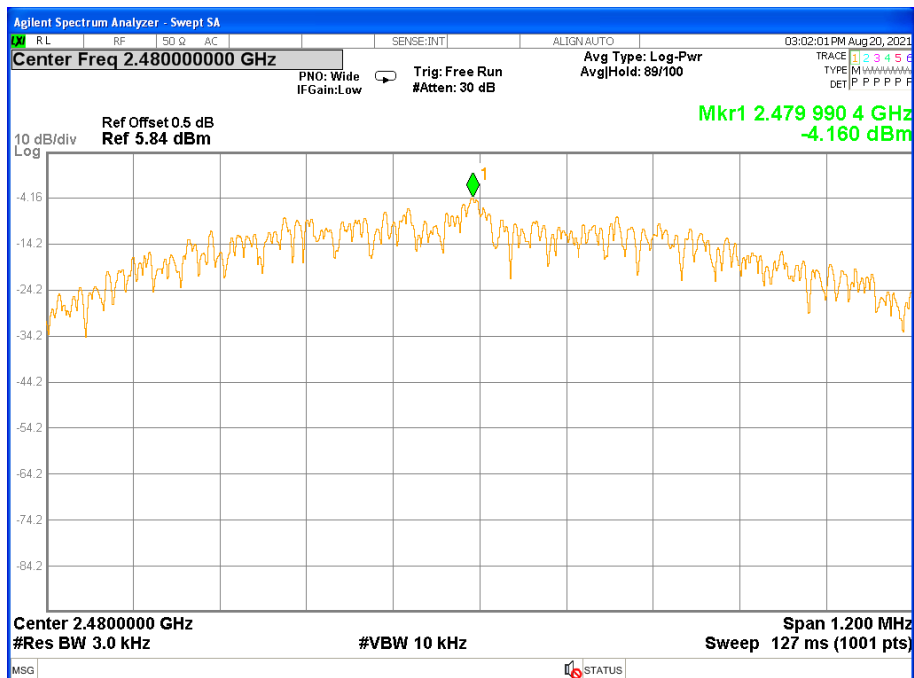



2M PHY

Frequency	Power Density	Limit (dBm/3KHz)	Result
	(dBm/3kHz)		
2402 MHz	1.382	≤8	PASS
2440 MHz	1.420	≤8	PASS
2480 MHz	2.066	≤8	PASS

TX CH00

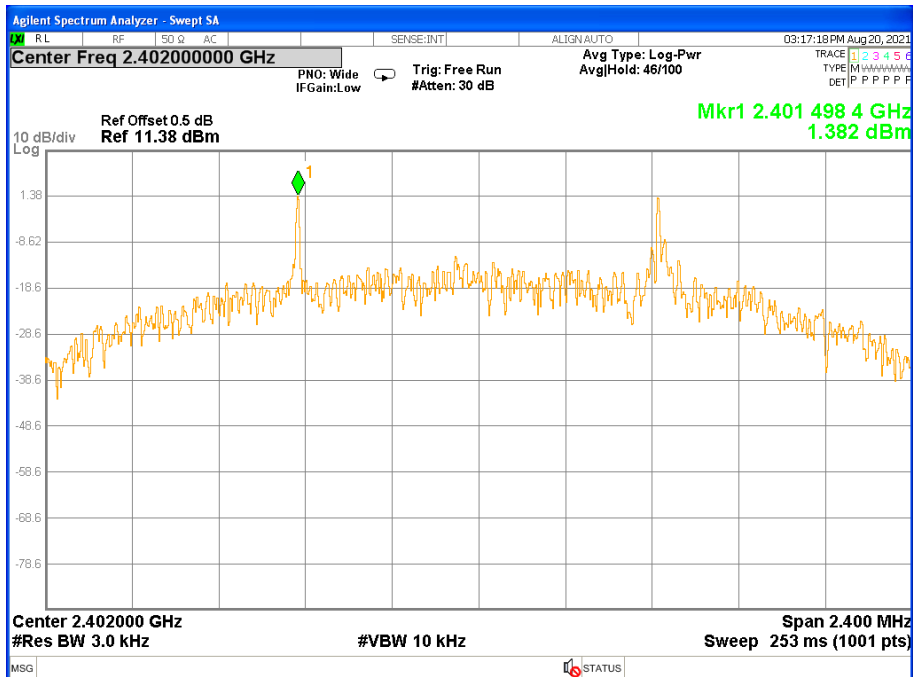



TX CH19

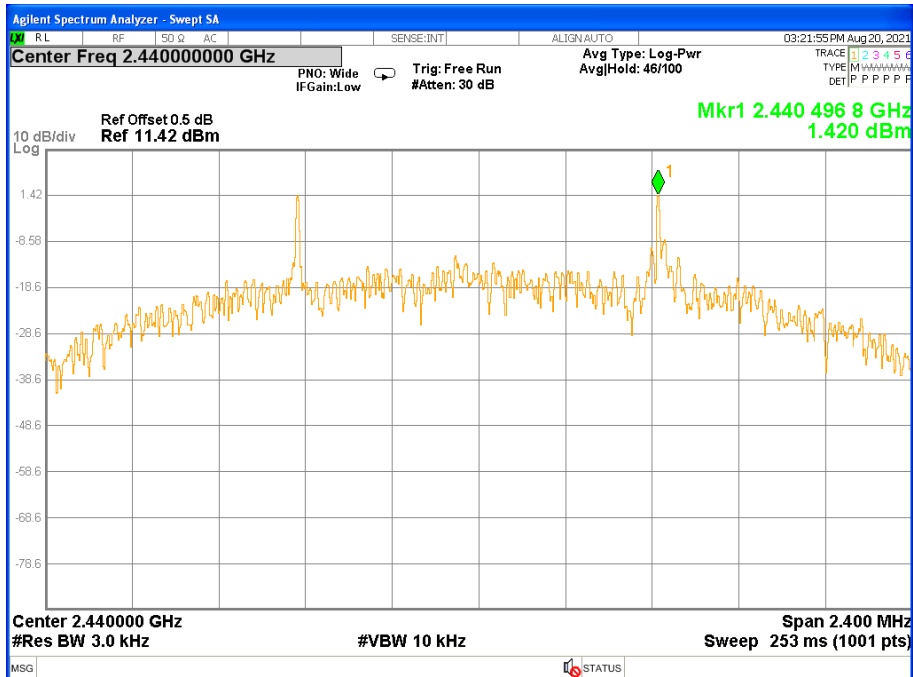

TX CH39

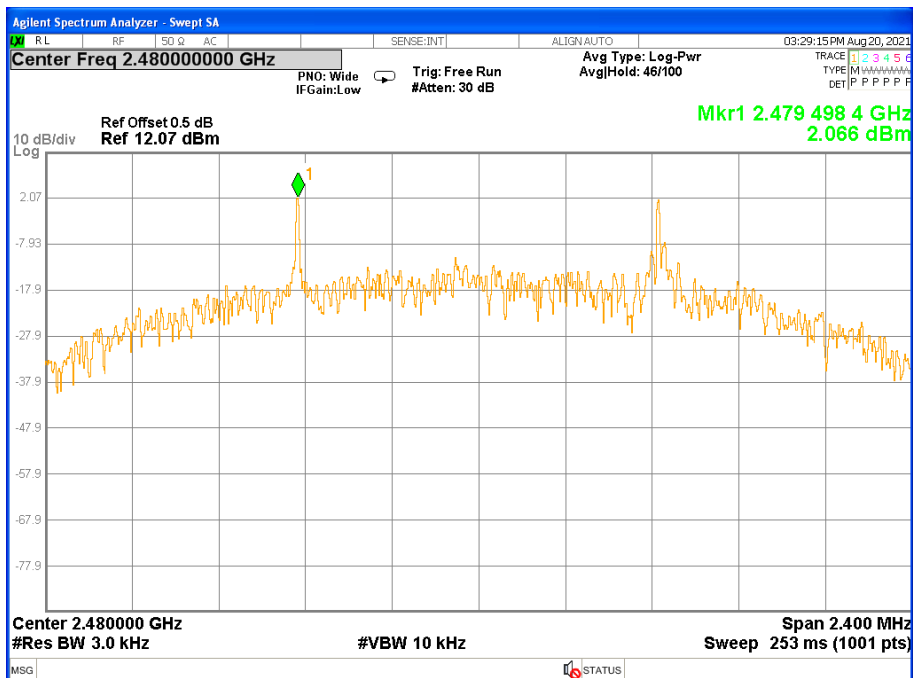

7. BANDWIDTH TEST

7.1 LIMIT

FCC Part 15.247, Subpart C				
Section	Test Item	Limit	Frequency Range (MHz)	Result
15.247(a)(2)	Bandwidth	$\geq 500\text{KHz}$ (6dB bandwidth)	2400-2483.5	PASS

7.2 TEST PROCEDURE

The automatic bandwidth measurement capability of an instrument may be employed using the X dB bandwidth mode with X set to 6 dB, if the functionality described above (i.e., RBW = 100 kHz, VBW ≥ 3 RBW, peak detector with maximum hold) is implemented by the instrumentation function. When using this capability, care shall be taken so that the bandwidth measurement is not influenced by any intermediate power nulls in the fundamental emission that might be ≥ 6 dB.

7.3 TEST SETUP



7.4 EUT OPERATION CONDITIONS

Please refer to section 3.4 of this report.



7.5 TEST RESULTS

Temperature:	25 °C	Relative Humidity:	60%
Test Voltage:	DC 3.7V	Test Mode:	TX Mode /CH00, CH19, CH39

1M PHY

Frequency	6dB Bandwidth (KHz)	Limit (KHz)	Result
2402 MHz	670.400	≥500KHz	PASS
2440 MHz	669.600	≥500KHz	PASS
2480 MHz	655.000	≥500KHz	PASS

TX CH 00

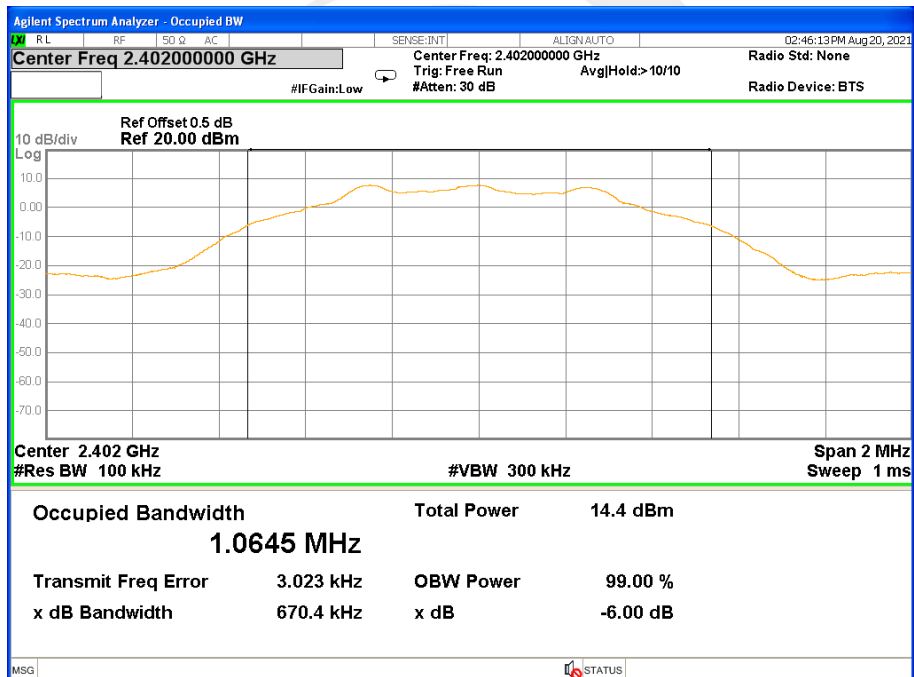



TX CH 19

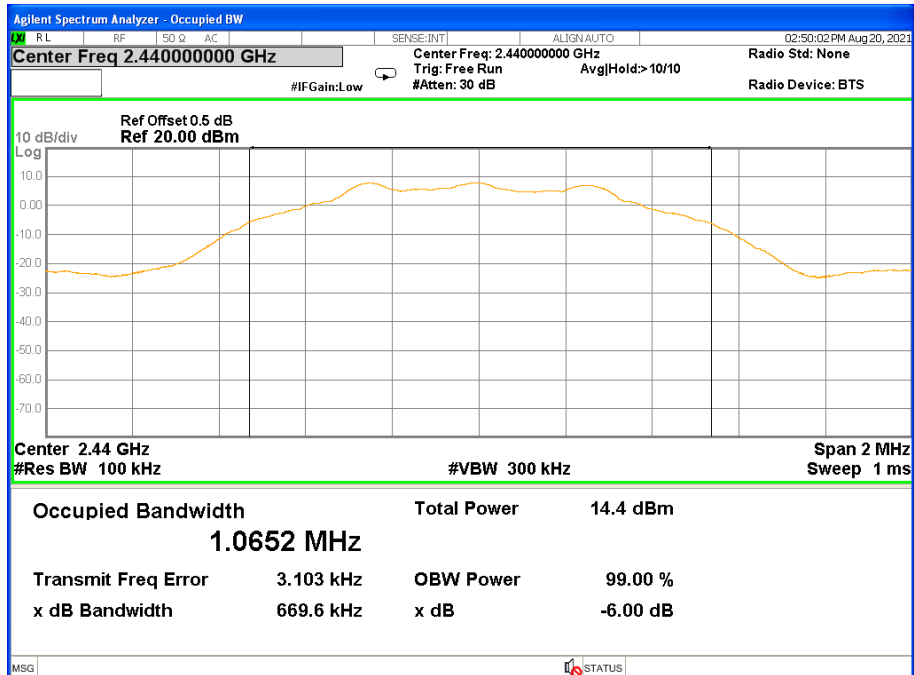

TX CH 39

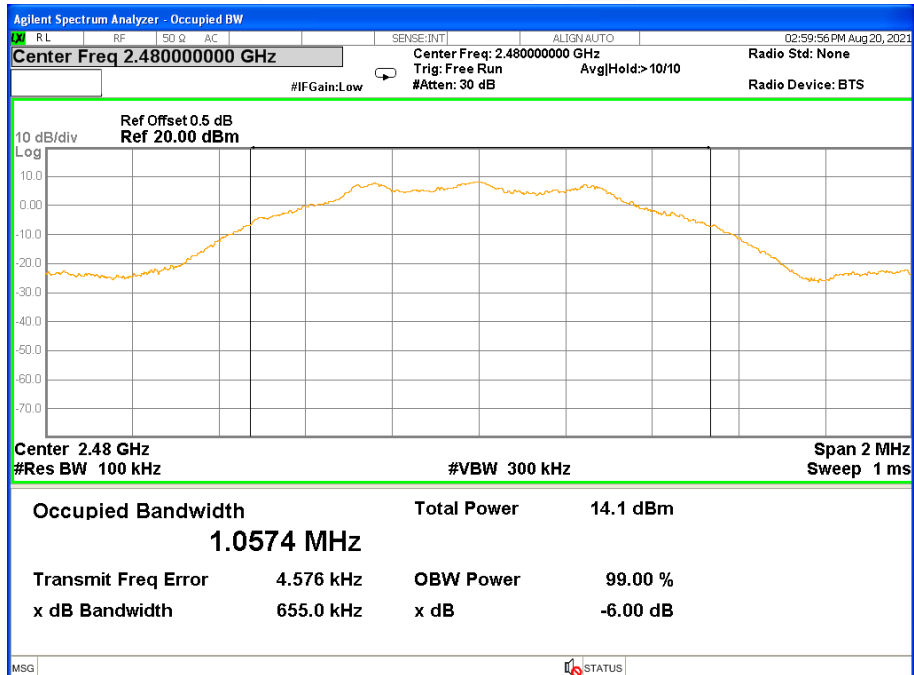



2M PHY

Frequency	6dB Bandwidth (KHz)	Limit (KHz)	Result
2402 MHz	1421.000	≥500KHz	PASS
2440 MHz	1417.000	≥500KHz	PASS
2480 MHz	1411.000	≥500KHz	PASS

TX CH 00

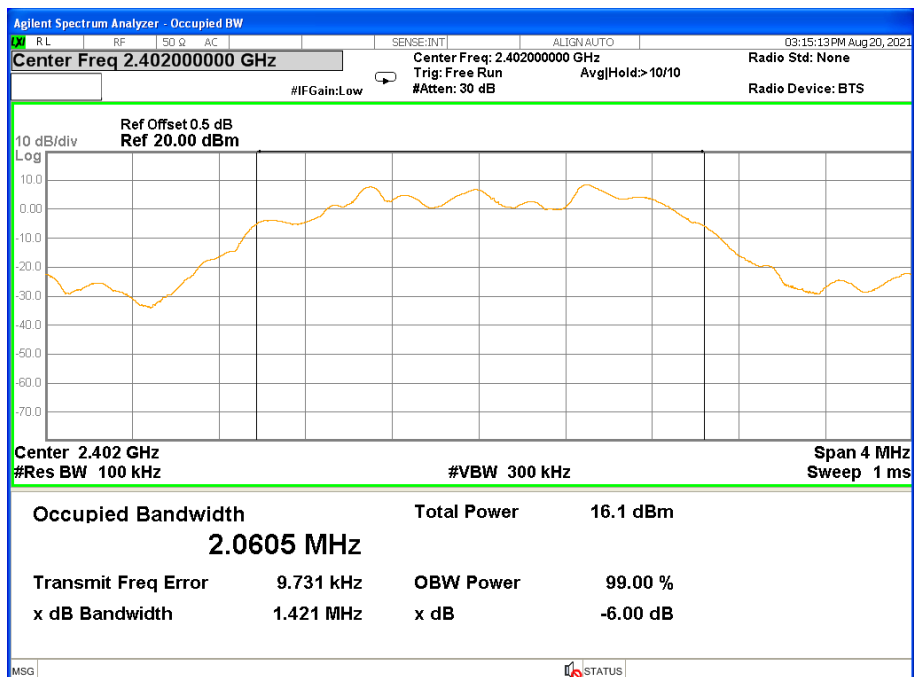



TX CH 19

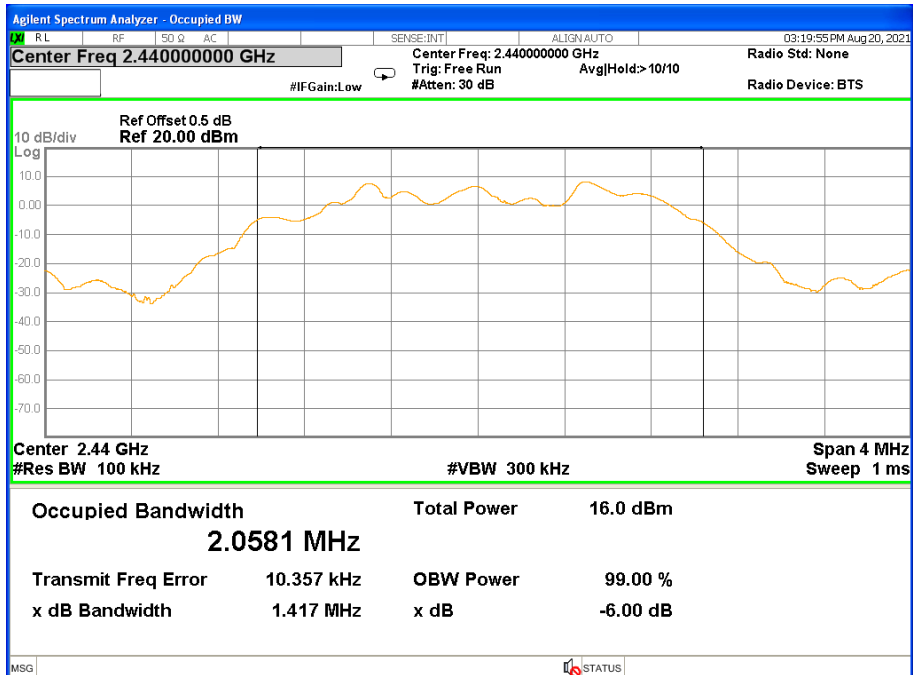

TX CH 39

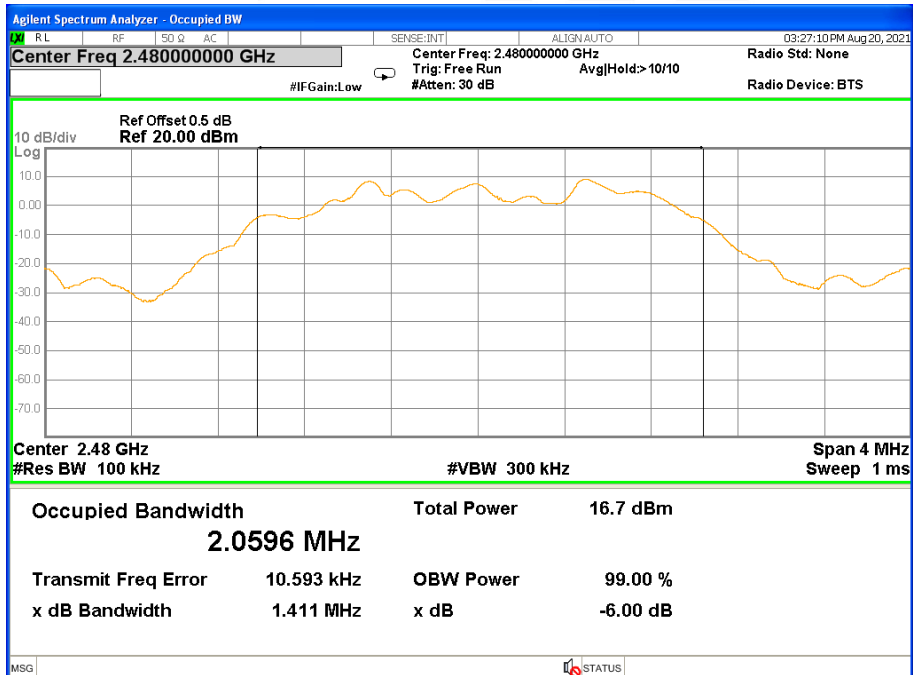



8. PEAK OUTPUT POWER TEST

8.1 LIMIT

FCC Part 15.247, Subpart C				
Section	Test Item	Limit	Frequency Range (MHz)	Result
15.247(b)(3)	Output Power	1 watt or 30dBm	2400-2483.5	PASS

8.2 TEST PROCEDURE

One of the following procedures may be used to determine the maximum peak conducted output power of a DTS EUT.

RBW \geq DTS bandwidth

The following procedure shall be used when an instrument with a resolution bandwidth that is greater than the DTS bandwidth is available to perform the measurement:

- Set the RBW \geq DTS bandwidth.
- Set VBW \geq [3 \times RBW].
- Set span \geq [3 \times RBW].
- Sweep time = auto couple.
- Detector = peak.
- Trace mode = max hold.
- Allow trace to fully stabilize.
- Use peak marker function to determine the peak amplitude level.

Integrated band power method:

The following procedure can be used when the maximum available RBW of the instrument is less than the

DTS bandwidth:

- Set the RBW = 1 MHz.
- Set the VBW \geq [3 \times RBW].
- Set the span \geq [1.5 \times DTS bandwidth].
- Detector = peak.
- Sweep time = auto couple.
- Trace mode = max hold.
- Allow trace to fully stabilize.
- Use the instrument's band/channel power measurement function with the band limits set equal to the DTS bandwidth edges (for some instruments, this may require a manual override to select the peak detector). If the instrument does not have a band power function, then sum the spectrum levels (in linear power units) at intervals equal to the RBW extending across the DTS channel bandwidth.

PKPM1 Peak power meter method:

The maximum peak conducted output power may be measured using a broadband peak RF power meter. The power meter shall have a video bandwidth that is greater than or equal to the DTS bandwidth and shall use a fast-responding diode detector.

8.3 TEST SETUP

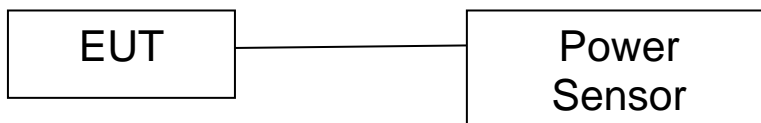

8.4 EUT OPERATION CONDITIONS

Please refer to section 3.4 of this report.



8.5 TEST RESULTS

Temperature:	25 °C	Relative Humidity:	60%
Test Voltage:	DC 3.7V	Test Mode:	TX Mode /CH00, CH19, CH39

1M PHY

Test Channe	Frequency	Peak Conducted Output Power	Average Conducted Output Power	LIMIT
	(MHz)	(dBm)	(dBm)	dBm
CH0	2402	7.97	4.31	30
CH19	2440	8.34	4.95	30
CH39	2480	9.21	5.12	30

2M PHY

Test Channe	Frequency	Peak Conducted Output Power	Average Conducted Output Power	LIMIT
	(MHz)	(dBm)	(dBm)	dBm
CH0	2402	8.55	4.38	30
CH19	2440	8.81	4.74	30
CH39	2480	9.35	5.22	30

Note: Our power sensor test AVG power has no duty cycle display. The power sensor measures AVG power is Burst power. The software has considered the factor of the duty cycle factor, so it is unnecessary to add it again.



Duty cycle
1M PHY

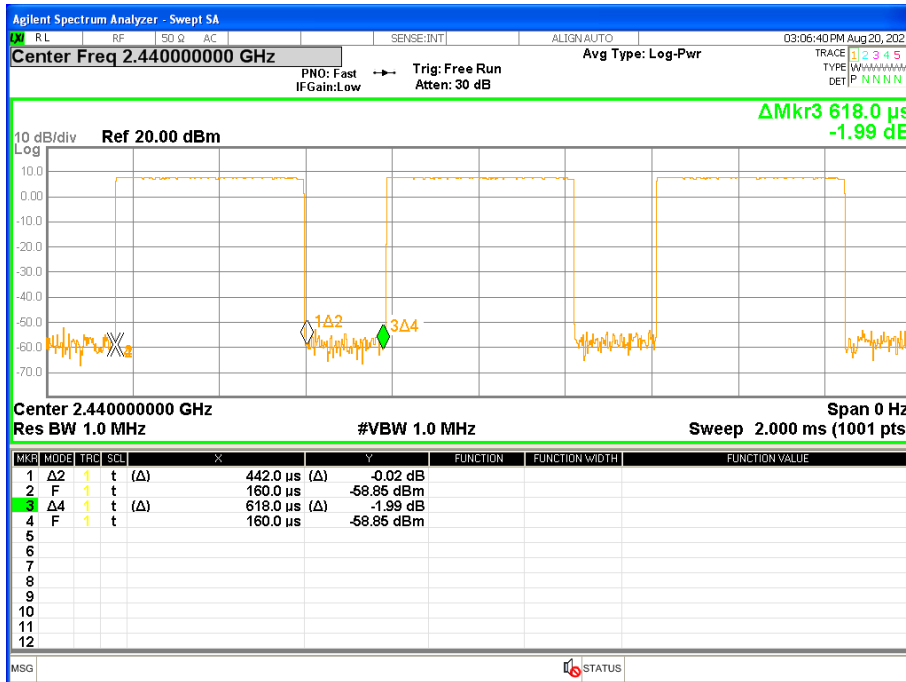

Ton	TP	Duty cycle(%)	Duty factor(dB)
0.442	0.618	71.52%	2.91

2M PHY

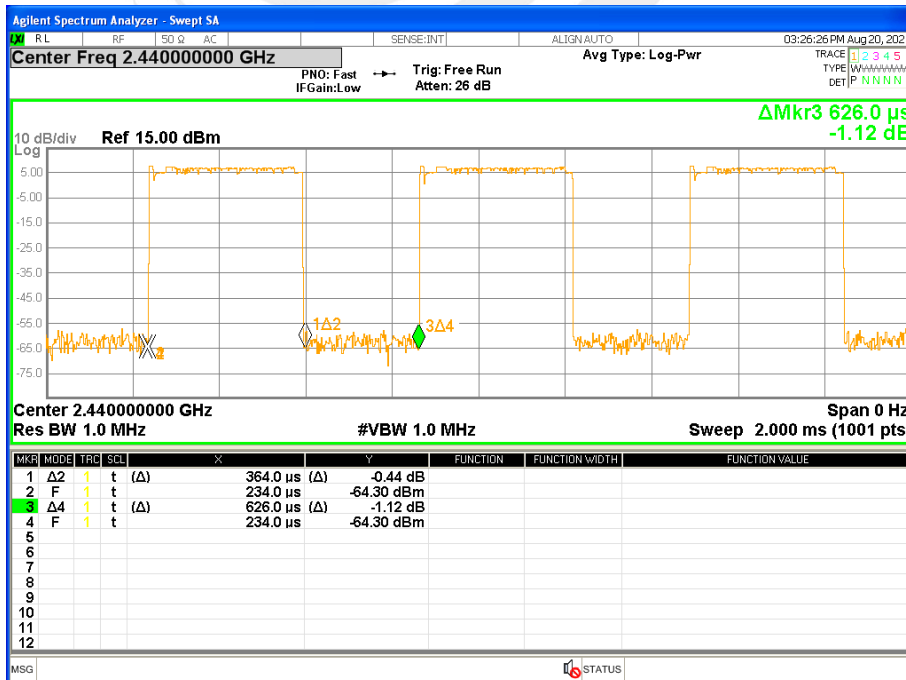

Ton	TP	Duty cycle(%)	Duty factor(dB)
0.364	0.626	58.15%	4.71



9. ANTENNA REQUIREMENT

9.1 STANDARD REQUIREMENT

15.203 requirement: For intentional device, according to 15.203: an intentional radiator shall be designed to ensure that no antenna other than that furnished by the responsible party shall be used with the device.

9.2 EUT ANTENNA

The EUT antenna is Ceramic Antenna. It comply with the standard requirement.





10. EUT TEST PHOTO

Note: See test photos in setup photo document for the actual connections between Product and support equipment.

*****END OF THE REPORT*****

