



# FCC TEST REPORT

For

Ekoo Electronic Co., Ltd

Jump Starter

Test Model: JS-1 Pro

Prepared for : Ekoo Electronic Co., Ltd  
Address : B09, Block B, F2, Bldg.B, Runfeng Pioneer Park, No.973, Minzhi Avenue, Minzhi St., Longhua, Shenzhen, CHINA 518000

Prepared by : Shenzhen LCS Compliance Testing Laboratory Ltd.  
Address : 101, 201 Bldg A & 301 Bldg C, Juji Industrial Park Shajing Street, Baoan District, Shenzhen, China  
Tel : (+86)755-82591330  
Fax : (+86)755-82591332  
Web : www.LCS-cert.com  
Mail : webmaster@LCS-cert.com

Date of receipt of test sample : June 27, 2024  
Number of tested samples : 2  
Sample No. : A240626091-1(Engineer sample), A240626091-2(Normal sample)  
Date of Test : June 27, 2024 ~ July 09, 2024  
Date of Report : July 10, 2024





<b>FCC TEST REPORT</b>	
<b>KDB 680106 D01 Wireless Power Transfer v04</b>	
<b>Report Reference No.</b> .....	<b>LCSA06274029EB</b>
<b>Date of Issue</b> .....	July 10, 2024
<b>Testing Laboratory Name</b> .....	<b>Shenzhen LCS Compliance Testing Laboratory Ltd.</b>
<b>Address</b> .....	101, 201 Bldg A & 301 Bldg C, Juji Industrial Park Shajing Street, Baoan District, Shenzhen, China
<b>Testing Location/ Procedure</b> .....	Full application of Harmonised standards <input checked="" type="checkbox"/> Partial application of Harmonised standards <input type="checkbox"/> Other standard testing method <input type="checkbox"/>
<b>Applicant's Name</b> .....	<b>Ekoo Electronic Co., Ltd</b>
<b>Address</b> .....	B09, Block B, F2, Bldg.B, Runfeng Pioneer Park, No.973, Minzhi Avenue, Minzhi St., Longhua, Shenzhen, CHINA 518000
<b>Test Specification</b>	
<b>Standard</b> .....	FCC CFR 47 PART 1, § 1.1310 KDB 680106 D01 Wireless Power Transfer v04
<b>Test Report Form No.</b> .....	LCSEMC-1.0
<b>TRF Originator</b> .....	Shenzhen LCS Compliance Testing Laboratory Ltd.
<b>Master TRF</b> .....	Dated 2023-12
<b>Shenzhen LCS Compliance Testing Laboratory Ltd. All rights reserved.</b>	
This publication may be reproduced in whole or in part for non-commercial purposes as long as the Shenzhen LCS Compliance Testing Laboratory Ltd. is acknowledged as copyright owner and source of the material. Shenzhen LCS Compliance Testing Laboratory Ltd. takes no responsibility for and will not assume liability for damages resulting from the reader's interpretation of the reproduced material due to its placement and context.	
<b>EUT Description</b> .....	<b>Jump Starter</b>
<b>Trade Mark</b> .....	N/A
<b>Test Model</b> .....	JS-1 Pro
<b>Ratings</b> .....	Capacity: 59.2Wh, 14.8V USB-C Input: 5V $\overline{\text{---}}$ 2A, 9V $\overline{\text{---}}$ 2A USB1 Output: 5V $\overline{\text{---}}$ 3A, 9V $\overline{\text{---}}$ 2A, 12V $\overline{\text{---}}$ 1.5A USB2 Output: 5V $\overline{\text{---}}$ 2.1A Wireless Charger: 10W
<b>Result</b> .....	<b>Positive</b>

Compiled by:

Supervised by:

Approved by:

*Nadia Zhou*

*Cary Luo*

*Gavin Liang*

Nadia Zhou/ Administrator

Cary Luo/ Technique principal

Gavin Liang/ Manager



Shenzhen LCS Compliance Testing Laboratory Ltd.  
 Add:101, 201 Bldg A & 301 Bldg C, Juji Industrial Park Yabianxueziwei, Shajing Street, Baoan District, Shenzhen, 518000, China  
 Tel: +(86) 0755-82591330 | E-mail: webmaster@lcs-cert.com | Web: www.lcs-cert.com  
 Scan code to check authenticity



### ISED -- TEST REPORT

<b>Test Report No. :</b> LCSA06274029EB	<u>July 10, 2024</u> Date of issue
---	---------------------------------------

Test Model.....	: JS-1 Pro
EUT.....	: Jump Starter
<b>Applicant.....</b>	<b>: Ekoo Electronic Co., Ltd</b>
Address.....	: B09, Block B, F2, Bldg.B, Runfeng Pioneer Park, No.973, Minzhi Avenue, Minzhi St., Longhua, Shenzhen, CHINA 518000
Telephone.....	:
Fax.....	:
<b>Manufacturer.....</b>	<b>: /</b>
Address.....	: /
Telephone.....	:
Fax.....	:
<b>Factory.....</b>	<b>: /</b>
Address.....	: /
Telephone.....	:
Fax.....	:

<b>Test Result</b>	<b>Positive</b>
--------------------	-----------------

The test report merely corresponds to the test sample.

It is not permitted to copy extracts of these test result without the written permission of the test laboratory.





### Revision History

Revision	Issue Date	Revisions	Revised By
000	July 10, 2024	Initial Issue	--





### TABLE OF CONTENTS

**1. GENERAL INFORMATION..... 6**

1.1. DESCRIPTION OF DEVICE (EUT) ..... 6

1.2. SUPPORT EQUIPMENT LIST ..... 6

1.3 EXTERNAL I/O CABLE ..... 6

1.4. DESCRIPTION OF TEST FACILITY ..... 6

1.5. TEST EQUIPMENT..... 6

1.6. MEASUREMENT UNCERTAINTY ..... 7

1.7. DESCRIPTION OF TEST MODES ..... 7

1.8. COIL DESCRIPTION ..... 7

1.9. COIL SIZE..... 7

1.10. COIL SPECIFICATIONS ..... 8

1.11. DUTY CYCLE..... 8

**2. TEST METHODOLOGY ..... 9**

2.1. REFERENCE EVALUATION METHOD..... 9

2.2. LIMIT..... 9

2.3. TEST SETUP DIAGRAM ..... 9

2.4. MEASUREMENT PROCEDURE..... 10

2.5. EQUIPMENT APPROVAL CONSIDERATIONS OF KDB 680106 D01v04 ..... 11

**3. TEST RESULTS..... 11**

3.3 CONCLUSION..... 15

**4. TEST SETUP PHOTOS..... 16**





## 1. GENERAL INFORMATION

### 1.1. Description of Device (EUT)

EUT	:	Jump Starter
Test Model	:	JS-1 Pro
Power Supply	:	Capacity: 59.2Wh, 14.8V USB-C Input: 5V $\overline{\text{---}}$ 2A, 9V $\overline{\text{---}}$ 2A USB1 Output: 5V $\overline{\text{---}}$ 3A, 9V $\overline{\text{---}}$ 2A, 12V $\overline{\text{---}}$ 1.5A USB2 Output: 5V $\overline{\text{---}}$ 2.1A Wireless Charger: 10W
Hardware Version	:	/
Software Version	:	/
Wireless Charging	:	
Operating Frequency	:	110.0~205.0KHz
Modulation Type	:	ASK
Antenna Type	:	Coil Antenna

### 1.2. Support equipment List

Manufacturer	Description	Model	Serial Number	Certificate
Iphone	Mobile Phone	X	---	FCC
SHENZHEN TIANYIN ELECTRONICS CO., LTD	Power Adapter	TPA-46050200UU	---	FCC

Note: Auxiliary equipment is provided by the laboratory.

### 1.3 External I/O Cable

I/O Port Description	Quantity	Cable
Type-C USB Port	1	N/A

### 1.4. Description of Test Facility

NVLAP Accreditation Code is 600167-0.

FCC Designation Number is CN5024

CAB identifier is CN0071.

CNAS Registration Number is L4595.

Test Firm Registration Number: 254912.

The 3m-Semi anechoic test site fulfils CISPR 16-1-4 according to ANSI C63.4:2014 and CISPR 16-1-4:2010 SVSWR requirement for radiated emission above 1GHz.

### 1.5. Test Equipment

Equipment	Manufacturer	Model	Serial no.	Calibrated date	Calibrated Due
Exposure Level Tester	Narda	ELT-400	N-0713	2023-10-18	2024-10-17
B-Field Probe	Narda	100cm <sup>2</sup>	M-1154	2023-10-18	2024-10-17

Exposure Level Tester ELT-400 detailed parameters are as follows:



Shenzhen LCS Compliance Testing Laboratory Ltd.

Add:101, 201 Bldg A & 301 Bldg C, Juji Industrial Park Yabianxueziwei, Shajing Street, Baoan District, Shenzhen, 518000, China

Tel: +(86) 0755-82591330 | E-mail: webmaster@lcs-cert.com | Web: www.lcs-cert.com

Scan code to check authenticity



Common parameter	
Operating temperature	-10 °C ~ +50 °C
Operation humidity	< 95 % (30 °C) or < 29 g/m <sup>3</sup>
Weight	910 g
Size	180 mm x 100 mm x 55 mm(Main engine) / 290 mm x 125 mm Ø (Probe)
Display	LCD backlit display, 4 refresh rates per second
Battery	Nimh battery (4 x Mignon, AA), rechargeable
Operating time, typical	12 h
Power supply	100 ~240 V AC / 47 ~ 63 Hz
Charging time, typical	2 hours
Recommended calibration cycle	24 months
Country of origin	Germany

### 1.6. Measurement Uncertainty

Test Item	Frequency Range	Uncertainty	Note
Field Strength Uncertainty	1Hz~400KHz	1%	(1)

(1). This uncertainty represents an expanded uncertainty expressed at approximately the 95% confidence level using a coverage factor of k=2.

### 1.7. Description of Test Modes

Equipment under test was operated during the measurement under the following conditions:

Charging and communication mode

Test Modes		
Mode 1	EUT + mobile phone (Battery Status: <1%)	Record
Mode 2	EUT + mobile phone (Battery Status: <50%)	Pre-tested
Mode 3	EUT + mobile phone (Battery Status: 100%)	Pre-tested

Note: All test modes were pre-tested, but we only recorded the worst case in this report.

### 1.8. Coil Description

Config.	Mode	Descriptions
1	Standby (Flatbed Position) @125kHz	EUT Alone powered by AC/DC adapter
2	Operating (Flatbed Position) (Phone @125kHz, ~10%, 20~50%, and >75% Power Charging)	EUT with lightning to AC/DC Adapter & Wireless Charging to WPT Client. 10W: Direct Contact 10W: 2mm Airgap, 2mm Shift Top as Worst-Case Position

### 1.9. Coil Size





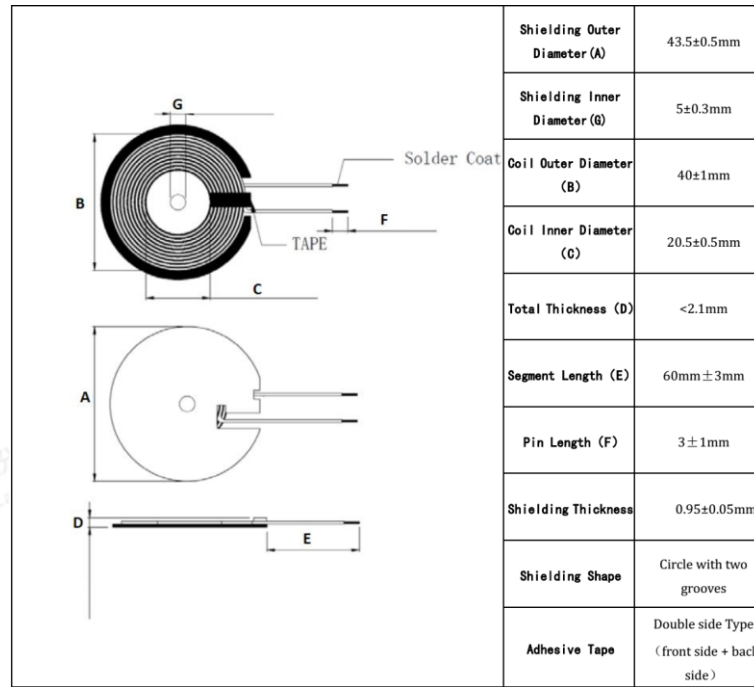

(Unit: mm)

1.10. Coil Specifications

Item	Parameter
Input inductance:	Transmitter 1: 6.5 μH±10%
Material of enclosure(s):	Multiple strands of enamelled wire
Number of turns:	Transmitter 1: 10 turns

1.11. Duty Cycle

Mode	ON Time (ms)	Period (ms)	Duty Cycle (%)
Operating (110.0~205.0KHz)	/	/	100

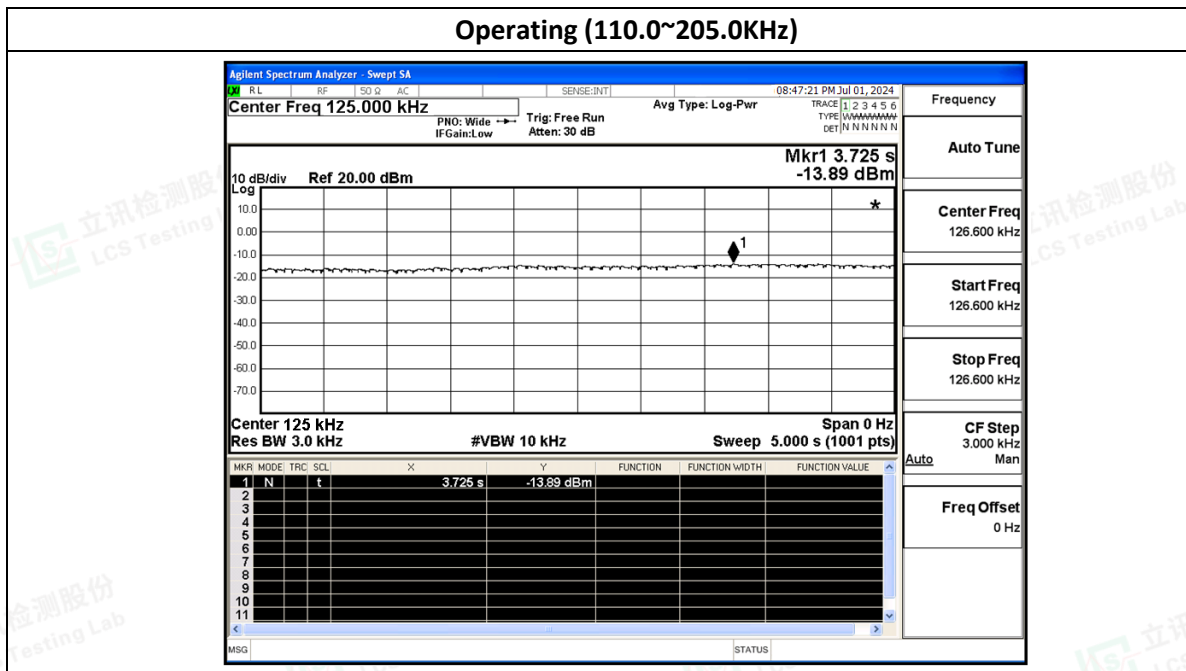





## 2. TEST METHODOLOGY

### 2.1. Reference Evaluation Method

ANSI C95.1–1999: IEEE Standard for Safety Levels with Respect to Human Exposure to Radio Frequency Electromagnetic Fields, 3 kHz to 300 GHz.

FCC KDB publication 680106 D01 RF Exposure Wireless Charging Apps v04: RF Exposure Considerations for Low Power Consumer Wireless Power Transfer Applications

FCC CFR 47 part1 1.1310: Radiofrequency radiation exposure limits.

FCC CFR 47 part2 2.1093: Radiofrequency radiation exposure evaluation: portable devices

FCC CFR 47 part 18.107: Industrial, Scientific, and Medical Equipment

April 2024 TCBC Workshop: Part 18 Wireless Power Transfer Devices: Clarifications on KDB 680106v04 and ECR Processes

### 2.2. Limit

§1.1310: The criteria listed in the following table shall be used to evaluate the environment impact of human exposure to radio frequency (RF) radiation as specified in §1.1307(b), except in the case of portable devices which shall be evaluated according to the provisions of FCC part 2.1093 of this chapter.

**Table 1 to §1.1310(e)(1) - Limits for Maximum Permissible Exposure (MPE)**

Frequency range (MHz)	Electric field strength (V/m)	Magnetic field strength (A/m)	Power density (mW/cm <sup>2</sup> )	Averaging time (minutes)
(i) Limits for Occupational/Controlled Exposure				
<b>0.3-3.0</b>	<b>614</b>	<b>1.63</b>	<b>*(100)</b>	<b>≤6</b>
<b>3.0-30</b>	<b>1842/f</b>	<b>4.89/f</b>	<b>*(900/f<sup>2</sup>)</b>	<b>&lt;6</b>
<b>30-300</b>	<b>61.4</b>	<b>0.163</b>	<b>1.0</b>	<b>&lt;6</b>
<b>300-1500</b>	<b>/</b>	<b>/</b>	<b>f/300</b>	<b>&lt;6</b>
<b>1500-100000</b>	<b>/</b>	<b>/</b>	<b>5</b>	<b>&lt;6</b>
(ii) Limits for General Population/Uncontrolled Exposure				
0.3-1.34	614	1.63	*(100)	<30
1.34-30	824/f	2.19/f	*(180/f <sup>2</sup> )	<30
30-300	27.5	0.073	0.2	<30
300-1500	/	/	f/1500	<30
1500-100000	/	/	1.0	<30

f = frequency in MHz

\* = Plane-wave equivalent power density

Note 1: Occupational/controlled exposure limits apply in situations in which persons are exposed as a consequence of their employment provided those persons are fully aware of the potential for exposure and can exercise control over their exposure.

Note 2: General population/uncontrolled exposure limits apply in situations in which the general public may be exposed, or in which persons who are exposed as a consequence of their employment may not be fully aware of the potential for exposure or cannot exercise control over their exposure.

### 2.3. Test Setup Diagram

#### Mobile Exposure Conditions



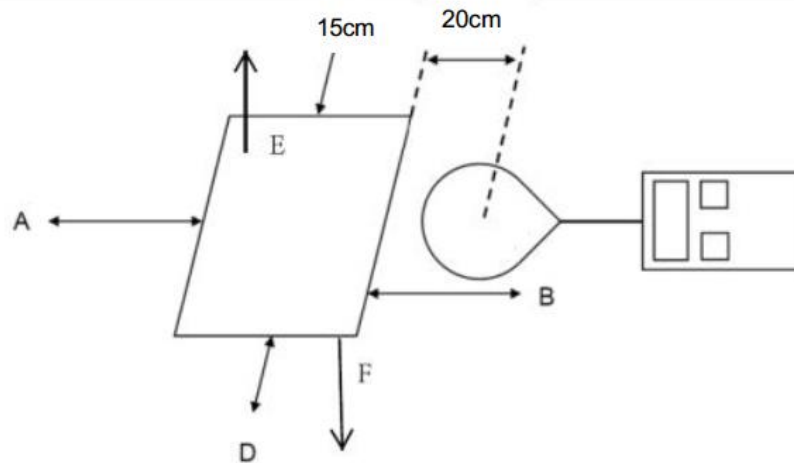

Note: The distance of the points A/B/C/D is 15cm, and the point E is 20cm.

#### Portable Exposure Conditions:

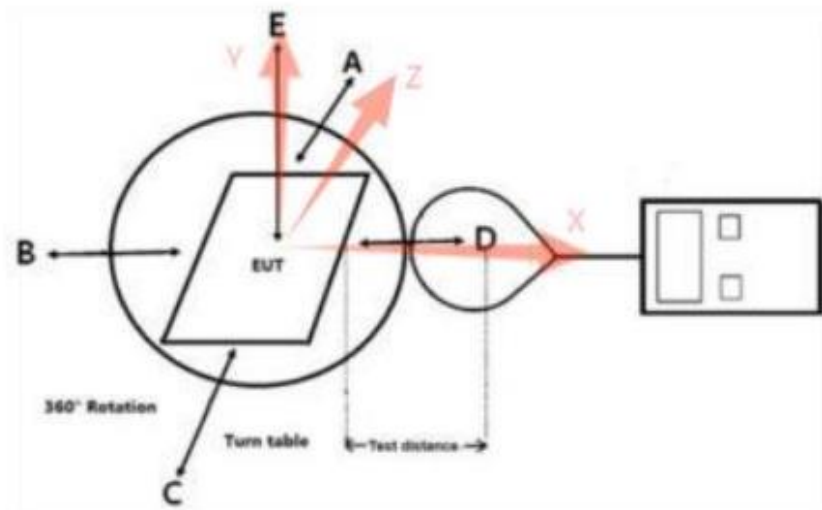

Note: The distance of the points A/B/C/D/E/F is 0,2,4,6,8,10,12,14,16,18, 20cm.

The values tested by the probe are X, Y, and Z on three axes perpendicular to the edge of the device. Top and bottom side coincident with the axis(Y) of the main coil.

## 2.4. Measurement Procedure

### Mobile Exposure Conditions

- The RF exposure test was performed in anechoic chamber.
- E and H-field measurements should be made with the center of the probe at 15 cm surrounding the EUT and 20 cm above the top surface of the primary/client pair.
- The highest emission level was recorded and compared with limit.
- The EUT was measured according to the KDB 680106 D01 Wireless Power Transfer v04.

### Portable Exposure Conditions

- The RF exposure test was performed in anechoic chamber.
- Perform H-field measurements for each edge/top surface of the host/client pair at every 2 cm, starting from as





close as possible out to 20 cm

- c. The highest emission level was recorded and compared with limit.
- d. The EUT was measured according to the KDB 680106 D01 Wireless Power Transfer v04.

## 2.5. Equipment Approval Considerations of KDB 680106 D01v04

Requirements of KDB 680106 D01	Yes / No	Description
Power transfer frequency is less than 1 MHz	Yes	The device operates in the frequency range 110.0~205.0KHz
The output power from each transmitting element (e.g., coil) is less than or equal to 15 watts.	Yes	The maximum output power of each primary coil is 10W.
A client device providing the maximum permitted load is placed in physical contact with the transmitter (i.e., the surfaces of the transmitter and client device enclosures need to be in physical contact)	Yes	Client device is placed directly in contact with the transmitter.
Only § 2.1091- Mobile exposure conditions apply (i.e., this provision does not cover § 2.1093-Portable exposure conditions).	No	Mixed mobile and portable exposure conditions
The E-field and H-field strengths, at and beyond 20 cm surrounding the device surface, are demonstrated to be less than 50% of the applicable MPE limit, per KDB 447498, Table 1. These measurements shall be taken along the principal axes of the device, with one axis oriented along the direction of the estimated maximum field strength, and for three points per axis or until a 1/d (inverse distance from the emitter structure) field strength decay is observed. Symmetry considerations may be used for test reduction purposes. The device shall be operated in documented worst-case compliance scenarios (i.e., the ones that lead to the maximum field components), and while all the radiating structures (e.g., coils or antennas) that by design can simultaneously transmit are energized at their nominal maximum power.	Yes	The E-field and H-field strengths from all simultaneous transmitting coils are demonstrated to less than 50% of the MPE limit.
For systems with more than one radiating structure, the conditions specified in (5) must be met when the system is fully loaded (i.e., clients absorbing maximum power available), and with all the radiating structures operating at maximum power at the same time, as per design conditions. If the design allows one or more radiating structures to be powered at a higher level while other radiating structures are not powered, then those cases must be tested as well. For instance, a device may use three RF coils powered at 5 W, or one coil powered at 15 W: in this case, both scenarios shall be tested	Yes	Only one radiating structure and tested at maximum Output Power

## 3. TEST RESULTS

### For portable exposure condition

- (1). The portable test modes have covered the considerations of the mobile test, only record the test data of the portable conditions in this report.
- (2) Operating modes with client device (1 %, 50%, 99% battery status of client device) have been test, only show the data of worst case of 1% battery status of client device.
- (3) Test performed with all the radiating structures operating at maximum power at the same time.
- (4) E-Filed and H-field measurements are taken along all three axes the device from 0cm~20cm in 2cm minimum increment for each edge surface of the host/client pair. If the center of the probe sensing element is more than 5mm



from the probe outer edge, the field strengths need to be estimated for the positions that are not reachable.

(5) Validation of Field Estimates

- (a) If R is the probe radius and the probe tip is in contact with the coil, then the probe center is R cm from the coil surface as bellowing picture

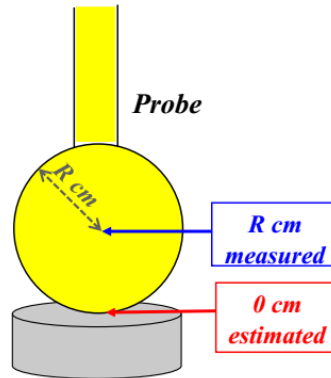

- (b) The probe then is measuring the field correctly at R cm from the surface, and only estimating the field at the 0 cm point of contact with the coil surface.
- (c) The validation requires showing that the model used to estimate the field provides data within 30% accuracy for at least the two, 2-cm-spaced closest points to where the estimates were made.
- (d) If there is only one estimated value, then a single validation point is sufficient.
- (e) Validation Example for 4 cm Probe Radius as following

Step 1

**Validation Example for 4 cm Probe Radius**

**1. Measure the field at 4 cm (closest position)**

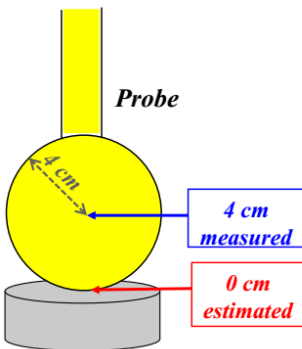

**2. Position the probe 2 cm from the DUT. Measure the field at 6 cm (probe calibration point)**

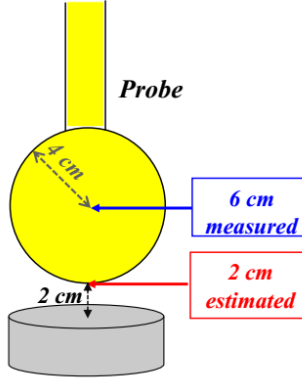

**3. Position the probe 4 cm from the DUT. Estimate the field at 4 cm. Compare with Step 1.**

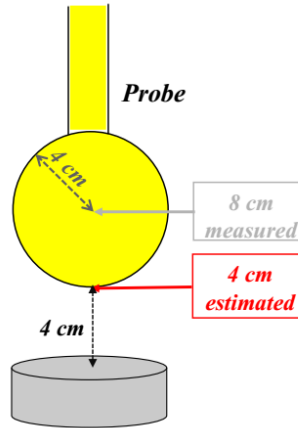

**4. Position the probe 6 cm from the DUT. Estimate the field at 6 cm. Compare with Step 2.**

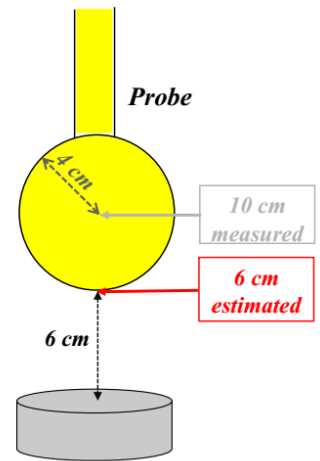

Step 2



### Validation Example for 4 cm Probe Radius

1. Measure the field at 4 cm (closest position)

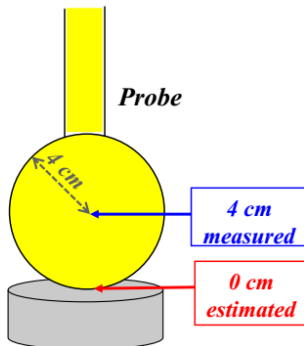

2. Position the probe 2 cm from the DUT. Measure the field at 6 cm (probe calibration point)

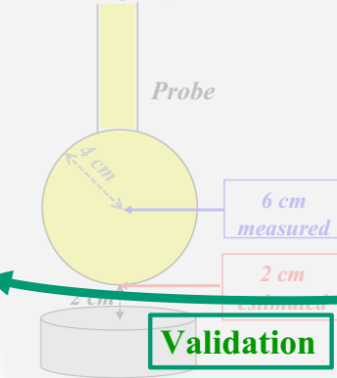

3. Position the probe 4 cm from the DUT. Estimate the field at 4 cm. Compare with Step 1.

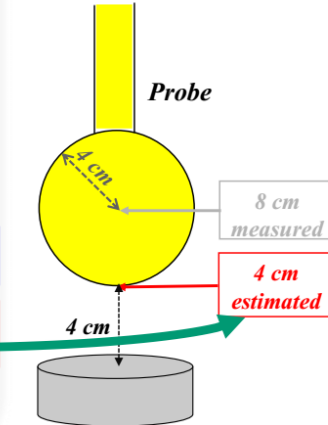

4. Position the probe 6 cm from the DUT. Estimate the field at 6 cm. Compare with Step 2.

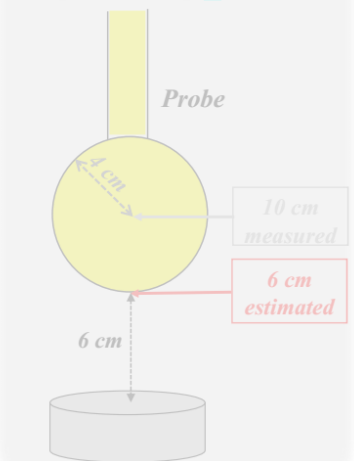

Step 3

### Validation Example for 4 cm Probe Radius

1. Measure the field at 4 cm (closest position)

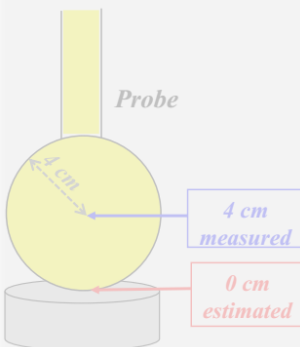

2. Position the probe 2 cm from the DUT. Measure the field at 6 cm (probe calibration point)

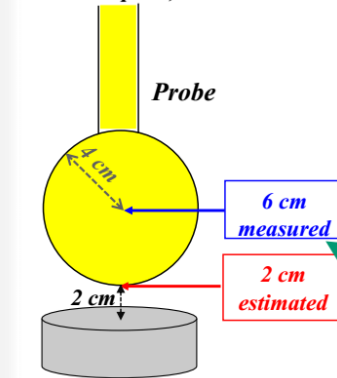

3. Position the probe 4 cm from the DUT. Estimate the field at 4 cm. Compare with Step 1.

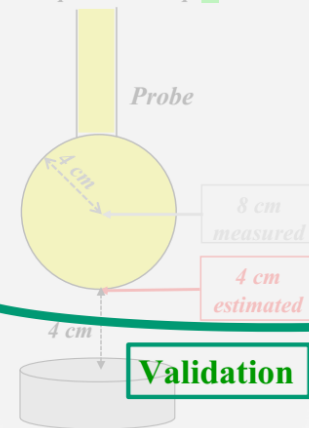

4. Position the probe 6 cm from the DUT. Estimate the field at 6 cm. Compare with Step 2.

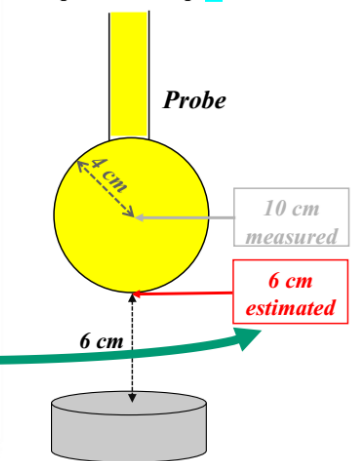

Description of the Validation Example for 4 cm Probe Radius

- Assume that  $R=4$  cm. The field at 0 cm can only be estimated, but the field at 4 cm is measured exactly (at the center of the probe).
- Move the probe at 2 cm from the surface. The field at 2 cm can still only be estimated, but the field at 6 cm is measured exactly.
- Compare the estimates with the values at the same positions where the field was measured exactly (i.e., 4 cm and 6 cm)
- The difference between measurements and estimates needs to be no more than 30%.
- That validation of the estimates needs to be for the two closest points to the coil, but at least 2 cm apart (in this case they are). This is to avoid a validation at, say 2 cm and another one at 2.1 cm, that is essentially a repetition







- (6) According to Calibration information and specification about ETL-400 Probe (the B-Field Probe size is 100cm<sup>2</sup>, the probe radius is 5.65cm), The Probe ETL-400 Probe's sensitive elements center is located in the probe's center, and the distance from the sensitive elements center to the tip of probe is 5.65cm.
- (7) The actual 0cm, 2cm, 4cm and 6cm field strengths need to be estimated for the positions that are not reachable via numerical calculation.
- (8) For validation purposes: If the value to show a 30% agreement between the mode and the probe measurements for the two closest points to the device surface, and with 2cm increments. Then this extrapolation method is reasonable.
- (9) Validation E-Field and H-Field as bellowing;

Validation Mode: TM1 H-Field (A/m)			Validation Position: Top	
	Results	Difference Values	Difference Limit	Conclusion
Estimated Distance: 0 cm	0.6726	28.63%	≤ 30%	Compliance
Measured Distance: 5.65 cm	0.5229		≤ 30%	Compliance
Estimated Distance: 2 cm	0.6123	29.40%	≤ 30%	Compliance
Measured Distance: 7.65 cm	0.4732		≤ 30%	Compliance
Estimated Distance: 4 cm	0.5439	25.53%	≤ 30%	Compliance
Measured Distance: 7.65 cm	0.4333		≤ 30%	Compliance

Validation Mode: TM1 E-Field (V/m)			Validation Position: Top	
	Results	Difference Values	Difference Limit	Conclusion
Estimated Distance: 0 cm	37.6346	27.24%	≤ 30%	Compliance
Measured Distance: 5.65 cm	29.5785		≤ 30%	Compliance
Estimated Distance: 2 cm	34.6318	27.88%	≤ 30%	Compliance
Measured Distance: 7.65 cm	27.0838		≤ 30%	Compliance
Estimated Distance: 4 cm	31.4018	29.74%	≤ 30%	Compliance
Measured Distance: 7.65 cm	24.2033		≤ 30%	Compliance

Note 1: The compliance location as probe tip;

Note 2: The format of difference is;

The E Validation Difference = (E<sub>Estimated Distance</sub> - E<sub>Measured Distance</sub>) / E<sub>Measured Distance</sub> \* 100%

The H Validation Difference = (H<sub>Estimated Distance</sub> - H<sub>Measured Distance</sub>) / H<sub>Measured Distance</sub> \* 100%

**H-Field and E-Field Emission level with a combination of measured and estimated results.**

**Test condition: Mode 1**

Distance(cm)	H-Field Result(A/m)							Limit(A/m)
	Type	Top	Bottom	Left	Right	Front	Back	
0	Estimate	0.6726	0.6172	0.6418	0.5520	0.5339	0.5301	1.63
2	Estimate	0.6123	0.5660	0.5896	0.4729	0.4270	0.4150	1.63
4	Estimate	0.5439	0.5428	0.5430	0.4511	0.4112	0.4099	1.63
6	Measured	0.4477	0.4363	0.4399	0.3895	0.3284	0.3174	1.63
8	Measured	0.3212	0.3146	0.3177	0.2876	0.2768	0.2659	1.63
10	Measured	0.2097	0.2092	0.2073	0.1866	0.1853	0.1746	1.63
12	Measured	0.1676	0.1505	0.1649	0.1252	0.1155	0.1043	1.63
14	Measured	0.1244	0.1134	0.1149	0.0940	0.0916	0.0886	1.63
16	Measured	0.0929	0.0923	0.0926	0.0737	0.0707	0.0682	1.63
18	Measured	0.0719	0.0716	0.0714	0.0635	0.0617	0.0594	1.63
20	Measured	0.0515	0.0502	0.0504	0.0428	0.0413	0.0383	1.63





Distance(cm)	E-Field Result(V/m)							Limit(V/m)
	Type	Top	Bottom	Left	Right	Front	Back	
0	Estimate	37.6346	36.1962	36.4427	32.1093	31.7649	31.4439	613
2	Estimate	34.6318	34.3618	34.0112	30.7501	29.5965	29.3199	613
4	Estimate	31.4018	30.7040	31.2582	28.0686	26.9480	26.7238	613
6	Measured	28.8124	27.0210	27.8954	23.7408	22.6442	22.4506	613
8	Measured	24.5791	23.1685	23.6928	20.5624	19.4973	19.2588	613
10	Measured	22.3619	21.2403	21.7777	17.6071	16.2662	16.1202	613
12	Measured	20.1038	19.3662	19.7387	15.3662	13.5027	13.1474	613
14	Measured	17.3181	17.0423	17.0713	13.1954	11.4101	11.1343	613
16	Measured	15.9630	14.7567	15.5478	10.2727	9.2381	9.1007	613
18	Measured	12.6947	11.6176	12.1981	8.3506	7.4280	7.2735	613
20	Measured	7.6495	7.4330	7.5319	5.2125	4.4722	3.9960	613

### 3.3 Conclusion

A minimum safety distance of 0 cm to the antenna is required when the device is charging a smart phone for portable exposure. The detected emissions are below the limitations according FCC KDB 680106.





### 4. TEST SETUP PHOTOS

(The separation distance from the geometric center of the probe to the edge of the device is 6.25cm)

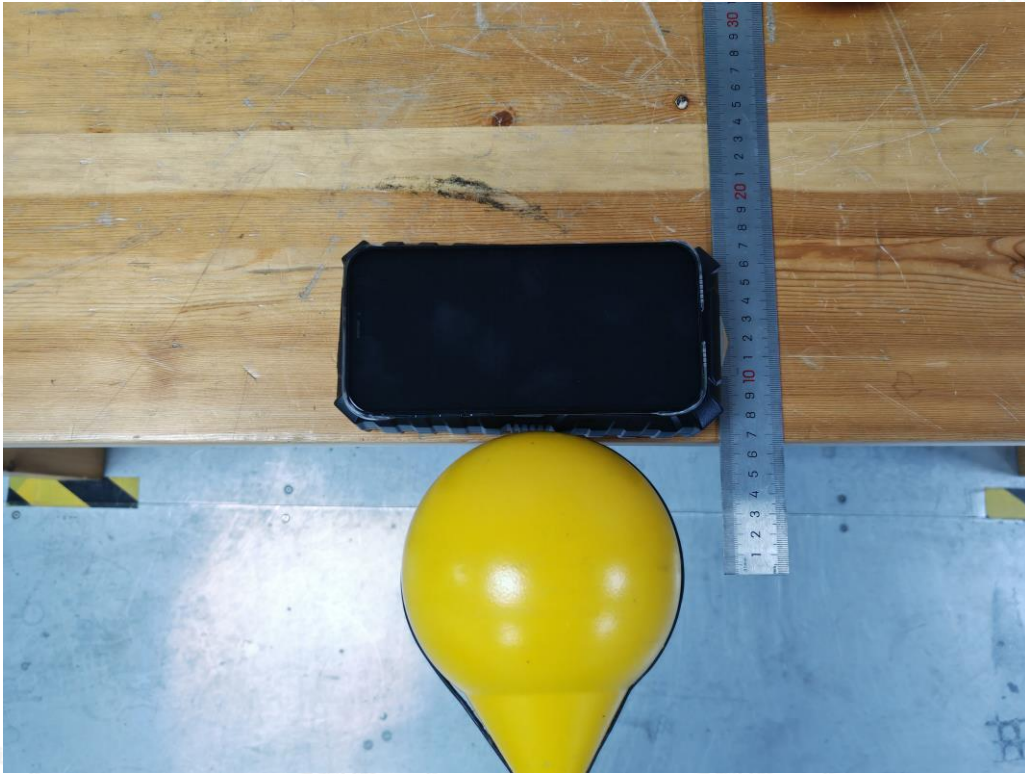

0cm-Left

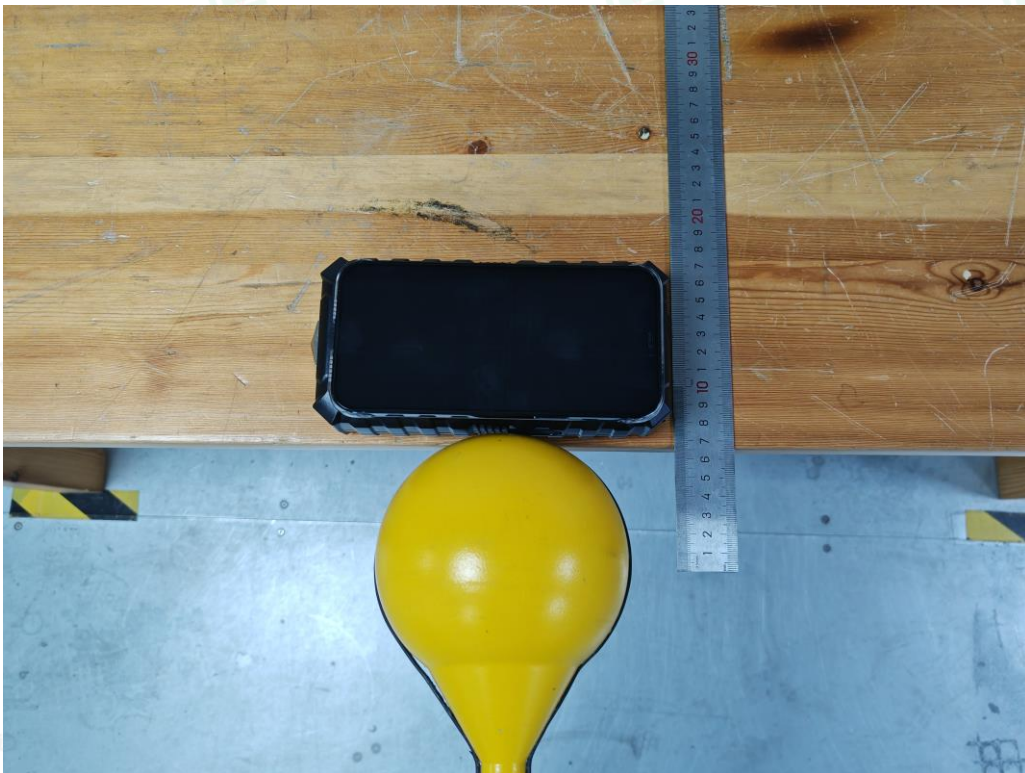

0cm-Right





0cm-Top

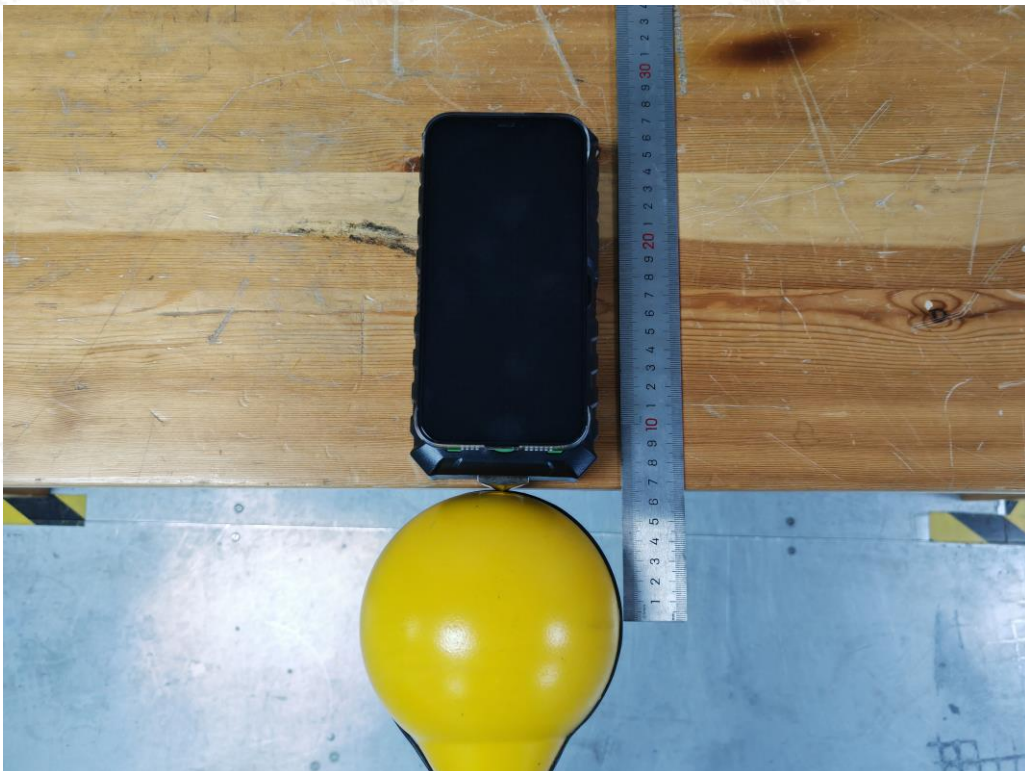

0cm-Bottom







0cm-Front



0cm-Back



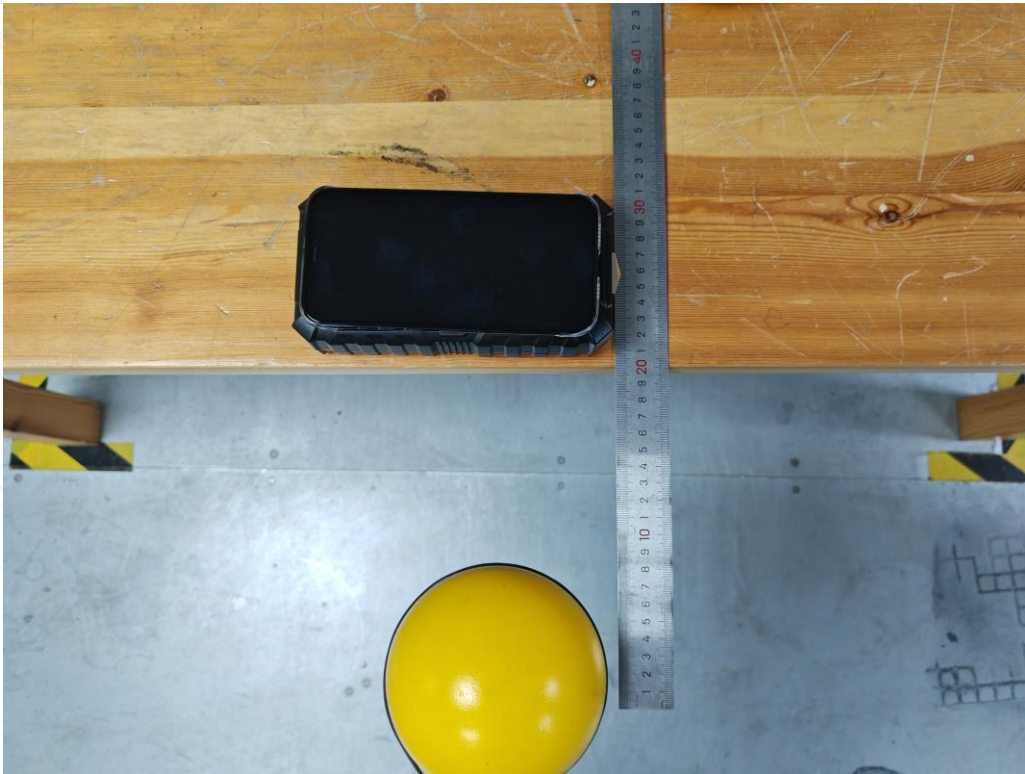

20cm-Left

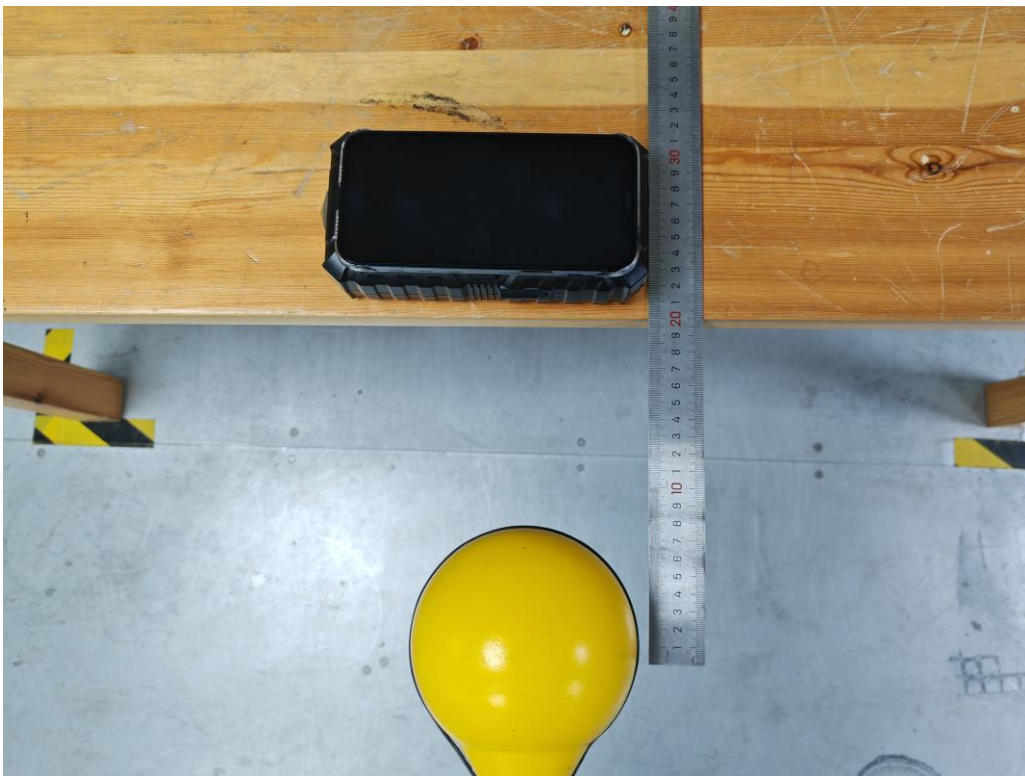

20cm-Right





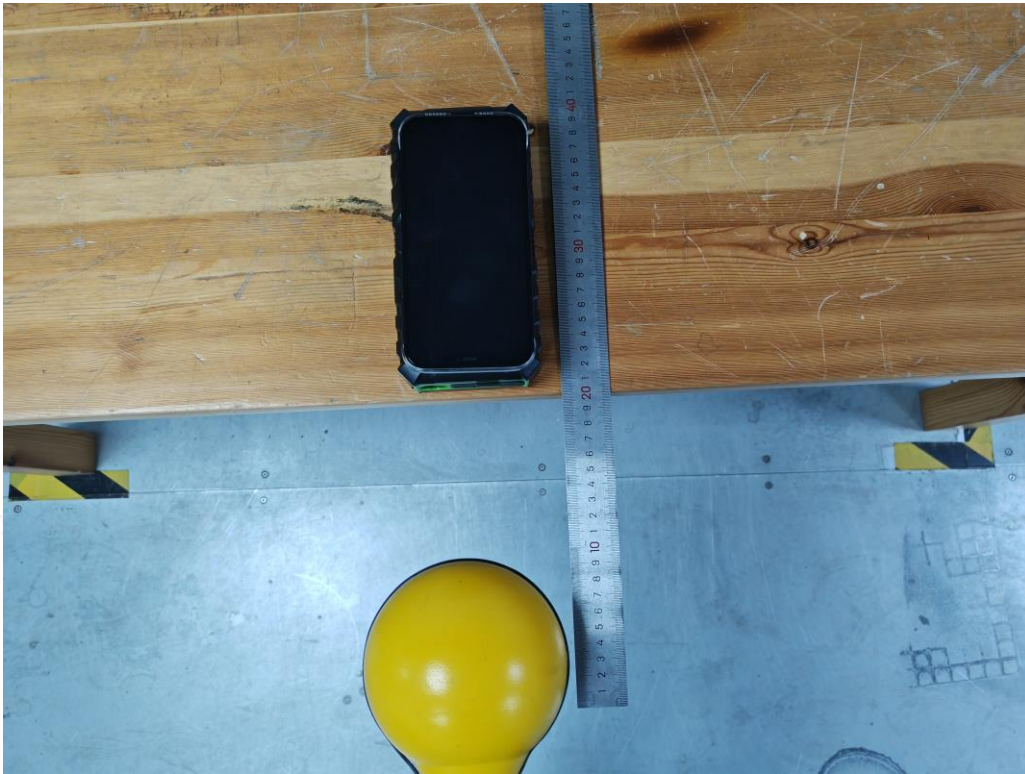

20cm-Top

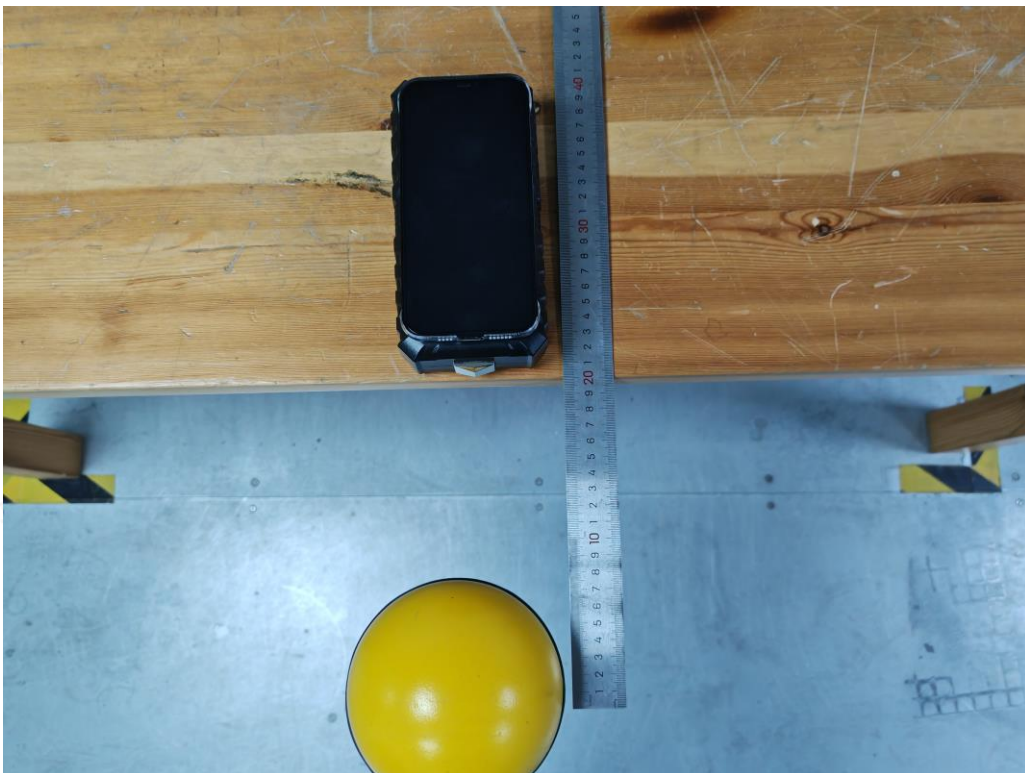

20cm-Bottom





20cm-Front



20cm-Back

-----THE END OF REPORT-----

