

2.4GHz 5221 Chip Antenna: RANT5221F245M02

1. Applications

WLAN, 802.11b/g, Bluetooth, WLAN, etc...

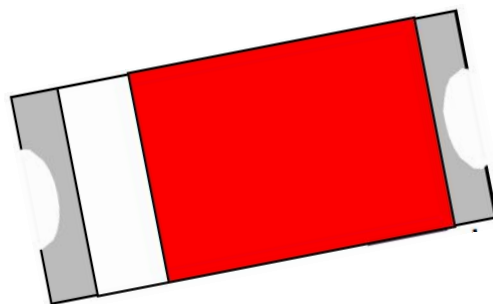

2. Features

SMD, high reliability, ultra Impact, Omni-directional...

3. Part Number Information

RANT 5221 F 245 M 02
 (A) (B) (C) (D) (E) (F)

(A)Product Type	Chip Antenna
(B) Size Code	5.0x2.0mm(±0.2mm)
(C) Material	High K material
(D) Frequency	2.4 ~ 2.5GHz
(E) Feeding mode	PIFA & Single Feeding
(F) Antenna type	Type=02

咏成國際科技有限公司

RAIN International Technology Co., Ltd.



4. 产品尺寸

5020单极天线

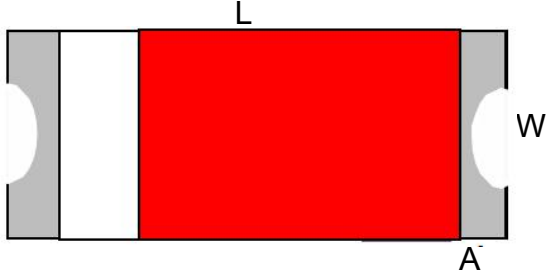
Figure	Symbol	Dimension (mm)
	L (长)	5.00 ± 0.20
	W (宽)	2.00 ± 0.30
	T (厚度)	1.0 ± 0.30
	A (电极宽度)	0.50 ± 0.20

5. Electrical Specification

Specification		
Part Number	RANT 5221 F245 M02	
Central Frequency	2450	MHz
Bandwidth	120 (Min.)	MHz
Return Loss	-10 (Max)	dB
Peak Gain	3.59	dBi
Impedance	50	Ohm
Operating Temperature	-40 ~ +85	°C
Maximum Power	4	W
Resistance to Soldering Heats	10 (@ 260°C)	sec.
Polarization	Linear	
Azimuth Beamwidth	Omni-directional	
Termination	Sn (Leadless)	

6. 推荐PCB

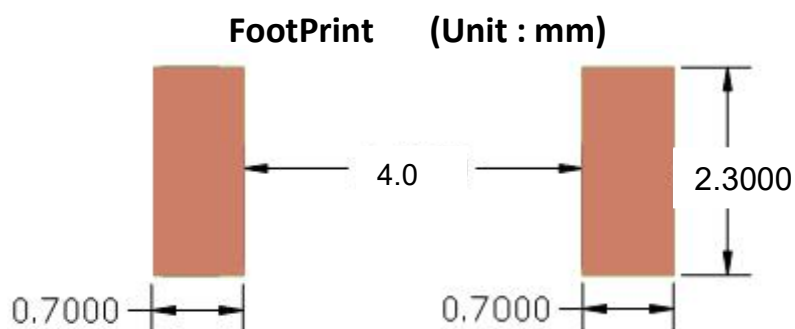

7. Measurement Results

Return Loss

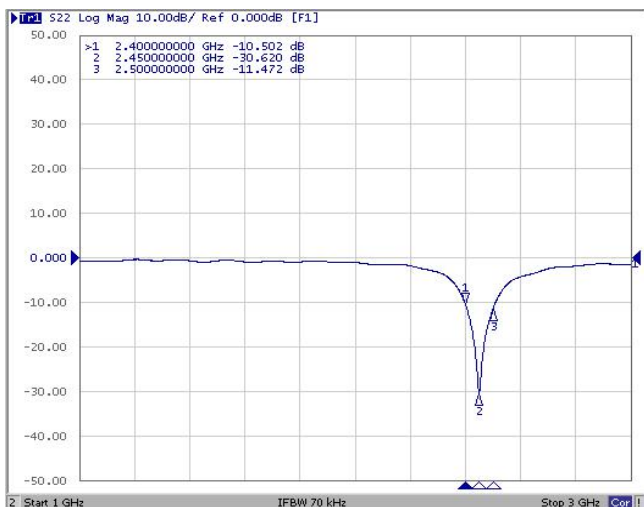

7.2 Radiation Pattern

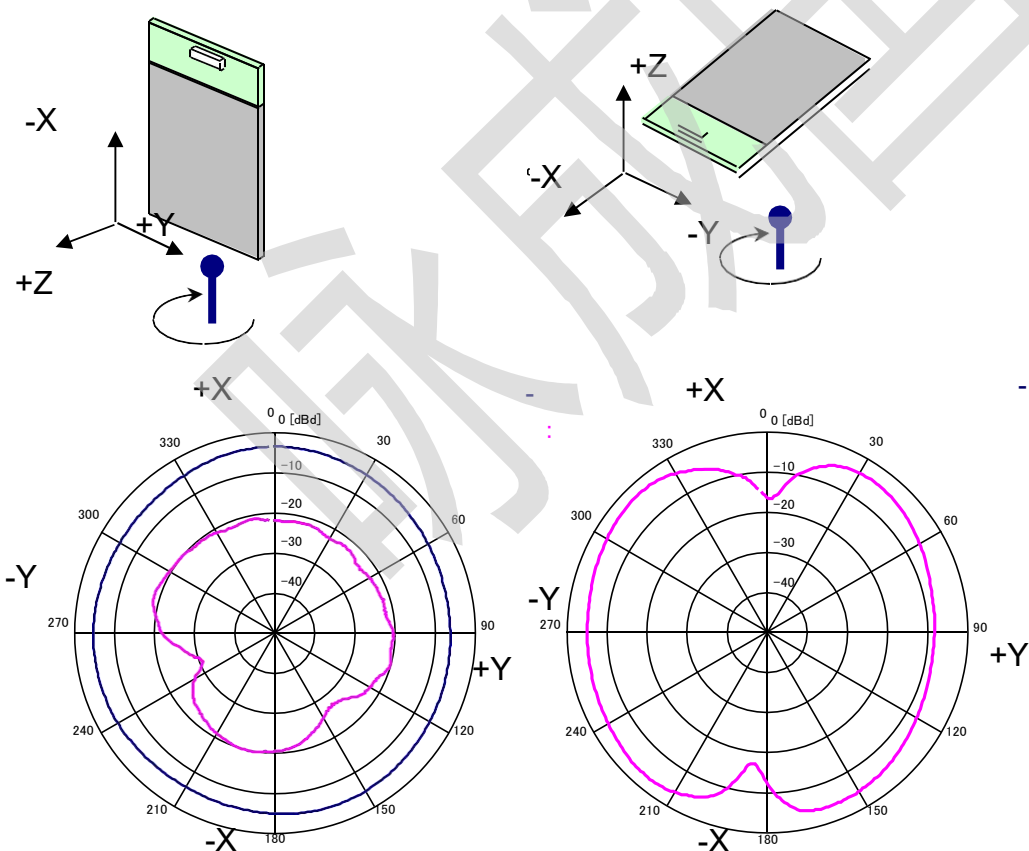

8. Reliability and Test Conditions

Test item	Test condition / Test method	Specification
Solderability JIS C 0050-4.6 JESD22-B102D	*Solder bath temperature: $235 \pm 5^{\circ}\text{C}$ *Immersion time: 2 ± 0.5 sec Solder: Sn3Ag0.5Cu for lead-free	At least 95% of a surface of each terminal electrode must be covered by fresh solder.
Leaching (Resistance to dissolution of metallization) IEC 60068-2-58	*Solder bath temperature: $260 \pm 5^{\circ}\text{C}$ *Leaching immersion time: 30 ± 0.5 sec Solder : SN63A	Loss of metallization on the edges of each electrode shall not exceed 25%.
Bending test JIS C 0051- 7.4.1	The middle part of substrate shall be pressurized by means of the pressurizing rod at a rate of about 1 mm/s per second until the deflection becomes 1mm/s and then pressure shall be maintained for 5 ± 1 sec. Measurement to be made after keeping at room temperature for 24 ± 2 hours	No mechanical damage. Electrical specification shall satisfy the descriptions in electrical characteristics under the operational temperature range within $-40 \sim 85^{\circ}\text{C}$.
Resistance to soldering heat JIS C 0050-5.4	*Preheating temperature: $120 \sim 150^{\circ}\text{C}$, 1 minute. *Solder temperature: $270 \pm 5^{\circ}\text{C}$ *Immersion time: 10 ± 1 sec Solder: Sn3Ag0.5Cu for lead-free Measurement to be made after keeping at room temperature for 24 ± 2 hrs	No mechanical damage. Electrical specification shall satisfy the descriptions in electrical characteristics under the operational temperature range within $-40 \sim 85^{\circ}\text{C}$. Loss of metallization on the edges of each electrode shall not exceed 25%.

9. Soldering and Mounting

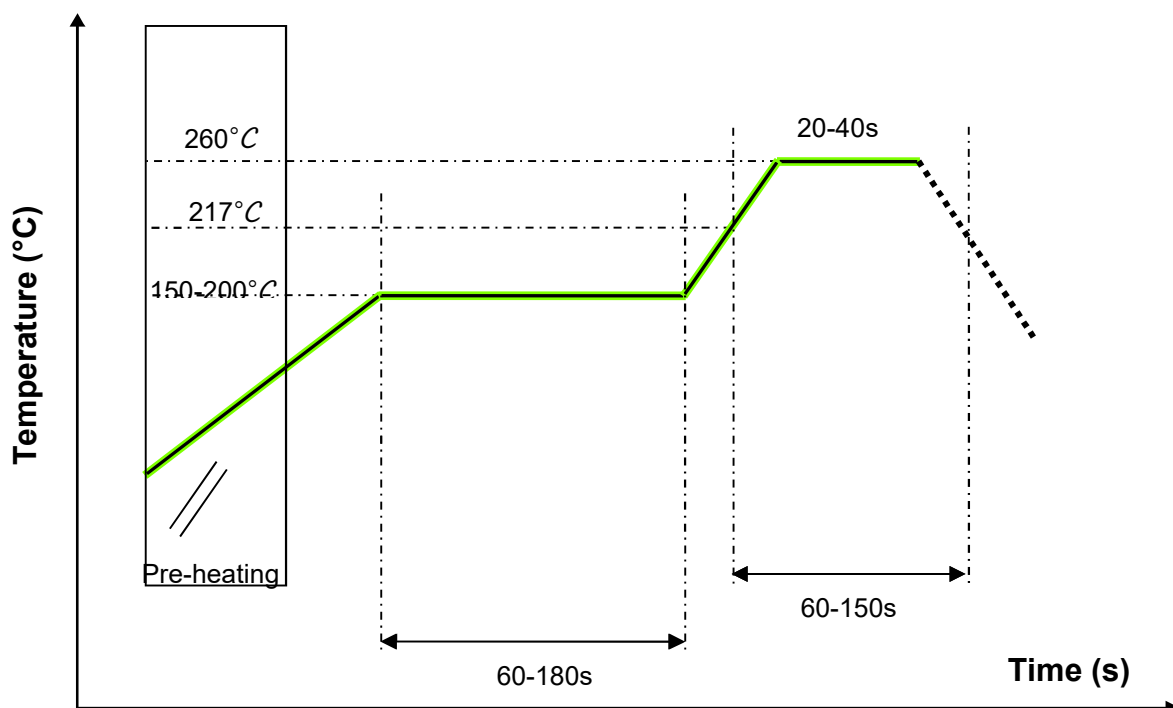

10. 天线应用注意事项

- 如果空间允许，最好不要选择太小尺寸的天线。
- 最好天线与附近物体之间有较大的净空区；否则匹配调节将会变得困难，辐射模式会受到严重扭曲。
- 天线的下方不应出现线路布局、接地层。
- 天线不应和金属物体放置太近，比如电池、芯片等，不应与电池等金属物有重叠。
- 注意内部缆线（如电池电源线）最好不要太靠近天线。
- 单极天线需要有合理的接地面才能发挥最好效果。
- 在最终产品方案上进行天线匹配，可以减短调节周期；而在光板上往往需要反复调节。
- 如果没有经过匹配，相同的天线放置完全不一样的布局板上可能无法正常工作。
- 不要使用金属外壳或带金属的塑料外壳盖在天线周围。
- 不要使用很细的天线馈电线，馈线应有一定的宽度，不应小于 0.1mm。
- 根据 PCB 的厚度和介电常数计算馈线阻抗，50 欧姆会使天线调节较为容易
- 片式天线装配应尽可能远离电池、EMI 防护材料、折叠扬声器、金属镙钉、LCD 显示屏等。

11. Storage and Transportation Information

Storage Conditions

To maintain the solderability of terminal electrodes:

1. Temperature and humidity conditions: -10~ 40°C and 30~70% RH.
2. Recommended products should be used within 6 months from the time of delivery.
3. The packaging material should be kept where no chlorine or sulfur exists in the air.

Transportation Conditions

1. Products should be handled with care to avoid damage or contamination from perspiration and skin oils.
2. The use of tweezers or vacuum pick up is strongly recommended for individual components.
3. Bulk handling should ensure that abrasion and mechanical shock are minimized.

12. Packing

(1) Quantity/Reel: 2000 pcs/Reel

(2) Plastic tape:

a. Tape Drawing

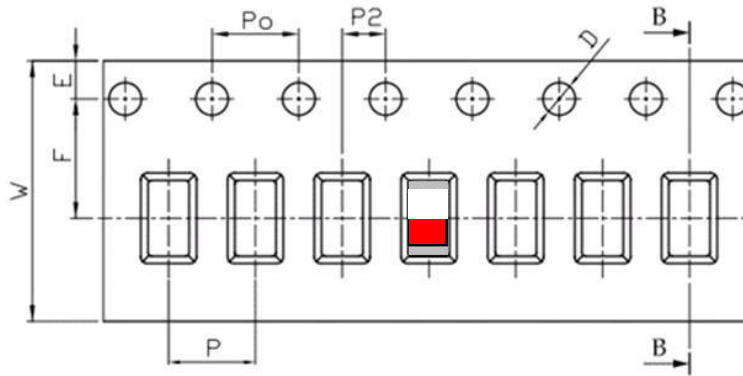

b. Tape Dimensions (unit: mm)

Feature	Specifications	Tolerances
W	12.00	±0.30
P	4.00	±0.10
E	1.75	±0.10
F	5.50	±0.10
P2	2.00	±0.10
D	1.50	+0.10 -0.00
P ₀	4.00	±0.10
10P ₀	40.00	±0.20

c. Reel Drawing

