



Shenzhen Global Test Service Co.,Ltd.

No.7-101 and 8A-104, Building 7 and 8, DCC Cultural and Creative Garden, No.98, Pingxin North Road, Shangmugu Community, Pinghu Street, Longgang District, Shenzhen, Guangdong

FCC PART 15 SUBPART C TEST REPORT

FCC PART 15.231

Report Reference No......: **GTS20220221011-1-11**

FCC ID.....: **2A2MQ-BELL18T**

Compiled by

(position+printed name+signature) .: File administrators Peter Xiao

Supervised by

(position+printed name+signature) .: Test Engineer Oliver Ou

Approved by

(position+printed name+signature) .: Manager Simon Hu

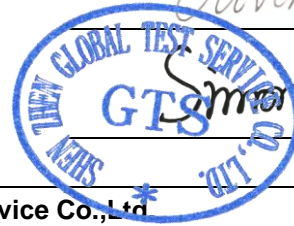

Date of issue: Mar.07, 2022

Representative Laboratory Name.: **Shenzhen Global Test Service Co.,Ltd**

Address: No.7-101 and 8A-104, Building 7 and 8, DCC Cultural and Creative Garden, No.98, Pingxin North Road, Shangmugu Community, Pinghu Street, Longgang District, Shenzhen, Guangdong,China

Applicant's name.....: **Hangzhou Arenti Technology Co., Ltd.**

Address: Room 1010,10th Floor, Building 1 , No.768 Jianghong Road, Changhe street, Binjiang District, Hangzhou, zhejiang, China

Test specification

Standard.....: **FCC Part 15.231**

TRF Originator.....: Shenzhen Global Test Service Co.,Ltd.

Master TRF: Dated 2014-12

Shenzhen Global Test Service Co.,Ltd. All rights reserved.

This publication may be reproduced in whole or in part for non-commercial purposes as long as the Shenzhen Global Test Service Co.,Ltd. is acknowledged as copyright owner and source of the material. Shenzhen Global Test Service Co.,Ltd. takes no responsibility for and will not assume liability for damages resulting from the reader's interpretation of the reproduced material due to its placement and context.

Test item description

Trade Mark: N/A

Manufacturer: Hangzhou Arenti Technology Co., Ltd.

Model/Type reference: BellCam

Listed Models: Bell 18S, Bell 18T, Bell 18Q, CD1

Modulation Type.....: OOK

Operation Frequency.....: From 433.92MHz

Hardware Version: PCB-BELL18S-T1MB-F51_REV1_0

Software Version: ppstrong-b8-m_neutral_std-3.0

Rating: DC 3.6V by battery
Recharged by DC 5.0V/1.0A

Result: **PASS**

TEST REPORT

Test Report No. :	GTS20220221011-1-11	Mar.07, 2022
		Date of issue

Equipment under Test : Wireless DoorBell

Model /Type : BellCam

Listed model : Bell 18S, Bell 18T, Bell 18Q, CD1

Applicant : **Hangzhou Arenti Technology Co., Ltd.**

Address : Room 1010,10th Floor, Building 1 , No.768 Jianghong Road, Changhe street, Binjiang District, Hangzhou, zhejiang, China

Manufacturer : **Hangzhou Arenti Technology Co., Ltd.**

Address : Room 1010,10th Floor, Building 1 , No.768 Jianghong Road, Changhe street, Binjiang District, Hangzhou, zhejiang, China

Test Result:	PASS
---------------------	-------------

The test report merely corresponds to the test sample.
It is not permitted to copy extracts of these test result without the written permission of the test laboratory.

Contents

1. TEST STANDARDS	4
2. SUMMARY	5
2.1. General Remarks	5
2.2. Product Description	5
2.3. Equipment Under Test	6
2.4. Short description of the Equipment under Test (EUT)	6
2.5. EUT operation mode	6
2.6. Block Diagram of Test Setup	6
2.7. EUT Exercise Software	7
2.8. Special Accessories	7
2.9. External I/O Cable	7
2.10. Related Submittal(s) / Grant (s)	7
2.11. Modifications	7
3. TEST ENVIRONMENT	8
3.1. Address of the test laboratory	8
3.2. Test Facility	8
3.3. Environmental conditions	8
3.4. Statement of the measurement uncertainty	8
3.5. Test Description	9
3.6. Equipments Used during the Test.....	10
4. TEST CONDITIONS AND RESULTS	11
4.1. AC Power Conducted Emission	11
4.2. Transmitter Field Strength of Emissions	14
4.3. Transmission Cease Time	23
4.4. 20dB Bandwidth Emissions.....	24
4.5. Duty cycle.....	25
4.6. Antenna Requirement	27
5. TEST SETUP PHOTOS OF THE EUT.....	28
6. EXTERNAL AND INTERNAL PHOTOS OF THE EUT	28

1. TEST STANDARDS

The tests were performed according to following standards:

[FCC Rules Part 15.231](#): Periodic operation in the band 40.66-40.70 MHz and above 70 MHz.

[ANSI C63.10-2013](#): American National Standard for Testing Unlicensed Wireless Devices

2. SUMMARY

2.1. General Remarks

Date of receipt of test sample	:	Feb.21, 2022
Testing commenced on	:	Feb.21, 2022
Testing concluded on	:	Mar.07, 2022

2.2. Product Description

Product Name	Wireless DoorBell
Trade Mark	N/A
Model/Type reference	BellCam
List Models	Bell 18S, Bell 18T, Bell 18Q, CD1
Model Declaration	PCB board, structure and internal of these model(s) are the same, Only the model name different , So no additional models were tested.
Power supply:	DC 3.6V by battery Recharged by DC 5.0V/1.0A
Sample ID	GTS20220221011-1-1#& GTS20220221011-1-2#& GTS20220221011-1-3#
WIFI(2.4G Band)	
Frequency Range	2412MHz ~ 2462MHz
Channel Spacing	5MHz
Channel Number	11 Channel for 20MHz bandwidth(2412~2462MHz)
Modulation Type	802.11b: DSSS; 802.11g/n: OFDM
Antenna Description	FPC Antenna, 3.64dBi(Max.)
SRD	
Frequency Range	433.92MHz
Channel Number	1Channel
Modulation Type	OOK
Antenna Description	FPC Antenna, -8.89dBi(Max.)

2.3. Equipment Under Test

Power supply system utilised

Power supply voltage	:	<input type="radio"/> 230V / 50 Hz	<input type="radio"/> 120V / 60Hz
		<input type="radio"/> 12 V DC	<input type="radio"/> 24 V DC
		<input checked="" type="radio"/> Other (specified in blank below)	

DC 5.0V

2.4. Short description of the Equipment under Test (EUT)

This is a Wireless DoorBell
 For more details, refer to the user's manual of the EUT.

2.5. EUT operation mode

Mode of Operations	Frequency Range (MHz)	Data Rate (Mbps)
SRD	433.92	1
For Conducted Emission		
Test Mode		TX Mode
For Radiated Emission		
Test Mode		TX Mode

Channel	Frequency(MHz)
1	433.92

The EUT has been tested under operating condition.

This test was performed with EUT in X, Y, Z position and the worst case was found when EUT in X position. Worst-case mode and channel used for 9 KHz-1000 MHz radiated emissions was the mode and channel with the highest output power, that was determined to be SRD mode.

2.6. Block Diagram of Test Setup

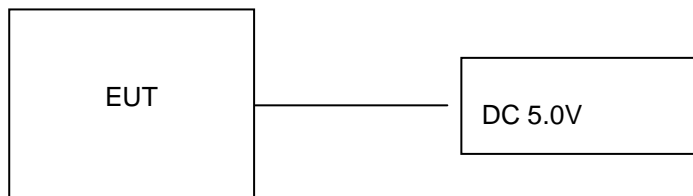

2.7. EUT Exercise Software

After the product is powered on, the signal is transmitted through the operation button.

2.8. Special Accessories

Manufacturer	Description	Model	Serial Number	Certificate
SHENZHEN TIANYIN ELECTRONICS CO.,LTD.	Adapter	TPA-46B050100UU	--	SDOC
SHENZHEN GREENPOWERONE CO., LTD.	Adapter	GTA92-0501000US	--	SDOC

2.9. External I/O Cable

I/O Port Description	Quantity	Cable
USB Port	1	1.0M, Unscreened Cable

2.10. Related Submittal(s) / Grant (s)

This submittal(s) (test report) is intended for **FCC ID: 2A2MQ-BELL18T** filing to comply with Section 15.247 of the FCC Part 15, Subpart C Rules.

2.11. Modifications

No modifications were implemented to meet testing criteria.

3. TEST ENVIRONMENT

3.1. Address of the test laboratory

Shenzhen Global Test Service Co.,Ltd.

No.7-101 and 8A-104, Building 7 and 8, DCC Cultural and Creative Garden, No.98, Pingxin North Road, Shangmugu Community, Pinghu Street, Longgang District, Shenzhen, Guangdong,China.

3.2. Test Facility

The test facility is recognized, certified, or accredited by the following organizations:

CNAS (No. CNAS L8169)

Shenzhen Global Test Service Co., Ltd. has been assessed and proved to be in compliance with CNAS-CL01 Accreditation Criteria for Testing and Calibration Laboratories (identical to ISO/IEC 17025: 2019 General Requirements) for the Competence of Testing and Calibration Laboratories.

A2LA (Certificate No. 4758.01)

Shenzhen Global Test Service Co., Ltd. has been assessed by the American Association for Laboratory Accreditation (A2LA). Certificate No. 4758.01.

Industry Canada Registration Number. is 24189.

FCC Designation Number is CN1234.

FCC Registered Test Site Number is165725.

3.3. Environmental conditions

During the measurement the environmental conditions were within the listed ranges:

Temperature:	15-35 ° C
Humidity:	30-60 %
Atmospheric pressure:	950-1050mbar

3.4. Statement of the measurement uncertainty

The data and results referenced in this document are true and accurate. The reader is cautioned that there may be errors within the calibration limits of the equipment and facilities. The measurement uncertainty was calculated for all measurements listed in this test report acc. to CISPR 16 - 4 „Specification for radio disturbance and immunity measuring apparatus and methods – Part 4: Uncertainty in EMC Measurements“ and is documented in the Shenzhen Global Test Service Co.,Ltd. quality system acc. to DIN EN ISO/IEC 17025. Furthermore, component and process variability of devices similar to that tested may result in additional deviation. The manufacturer has the sole responsibility of continued compliance of the device.

Hereafter the best measurement capability for Shenzhen GTS laboratory is reported:

Test	Range	Measurement Uncertainty	Notes
Radiated Emission	30~1000MHz	4.10 dB	(1)
Radiated Emission	1~18GHz	4.32 dB	(1)
Radiated Emission	18-40GHz	5.54 dB	(1)
Conducted Disturbance	0.15~30MHz	3.12 dB	(1)

This uncertainty represents an expanded uncertainty expressed at approximately the 95% confidence level using a coverage factor of k=2.

3.5. Test Description

Applied Standard: FCC Part 15 Subpart C				
ISED Rules	Description of Test	Test Sample	Result	Remark
§15.203	Antenna Requirement	GTS20220221011-1-1#	/	/
§15.205	Restricted Bands Of Operation	GTS20220221011-1-1#	Compliant	Note 1
§15.209	Radiated Emission Limits, General Requirements.	GTS20220221011-1-2# GTS20220221011-1-3#	Compliant	Note 1
§15.231 (b)	Field Strength Of Fundamental and Harmonics	GTS20220221011-1-2# GTS20220221011-1-3#	Compliant	Note 1
§15.231 (c)	20dB Bandwidth	GTS20220221011-1-1#	Compliant	Note 1
§15.231 (a)(1)	Transmission Cease Time	GTS20220221011-1-1#	Compliant	Note 1
§15.231	Duty cycle Factor	GTS20220221011-1-1#	Compliant	Note 1
§15.207	AC Conducted Emissions	GTS20220221011-1-2#	Compliant	Note 1

Remark:

1. The measurement uncertainty is not included in the test result.
2. NA = Not Applicable; NP = Not Performed
3. Note 1 – Test results inside test report;
4. Note 2 – Test results in other test report (MPE Report).
5. We tested all test mode and recorded worst case in report

3.6. Equipments Used during the Test

Test Equipment	Manufacturer	Model No.	Serial No.	Calibration Date	Calibration Due Date
LISN	CYBERTEK	EM5040A	E1850400105	2021/07/17	2022/07/16
LISN	R&S	ESH2-Z5	893606/008	2021/07/17	2022/07/16
EMI Test Receiver	R&S	ESPI3	101841-cd	2021/07/17	2022/07/16
EMI Test Receiver	R&S	ESCI7	101102	2021/09/19	2022/09/18
Spectrum Analyzer	Agilent	N9020A	MY48010425	2021/09/19	2022/09/18
Spectrum Analyzer	R&S	FSV40	100019	2021/07/17	2022/07/16
Vector Signal generator	Agilent	N5181A	MY49060502	2021/07/17	2022/07/16
Signal generator	Agilent	N5182A	3610AO1069	2021/09/19	2022/09/18
Climate Chamber	ESPEC	EL-10KA	A20120523	2021/09/19	2022/09/18
Controller	EM Electronics	Controller EM 1000	N/A	N/A	N/A
Horn Antenna	Schwarzbeck	BBHA 9120D	01622	2021/09/19	2022/09/18
Active Loop Antenna	Beijing Da Ze Technology Co.,Ltd.	ZN30900C	15006	2021/09/19	2022/09/18
Bilog Antenna	Schwarzbeck	VULB9163	000976	2021/08/08	2022/08/07
Broadband Horn Antenna	SCHWARZBECK	BBHA 9170	791	2021/09/19	2022/09/18
Amplifier	Schwarzbeck	BBV 9743	#202	2021/07/17	2022/07/16
Amplifier	Schwarzbeck	BBV9179	9719-025	2021/07/17	2022/07/16
Amplifier	EMCI	EMC051845B	980355	2021/07/17	2022/07/16
Temperature/Humidity Meter	Gangxing	CTH-608	02	2021/07/17	2022/07/16
High-Pass Filter	K&L	9SH10-2700/X12750-O/O	KL142031	2021/07/17	2022/07/16
High-Pass Filter	K&L	41H10-1375/U12750-O/O	KL142032	2021/07/17	2022/07/16
RF Cable(below 1GHz)	HUBER+SUHNER	RG214	RE01	2021/07/17	2022/07/16
RF Cable(above 1GHz)	HUBER+SUHNER	RG214	RE02	2021/07/17	2022/07/16
Data acquisition card	Agilent	U2531A	TW53323507	2021/07/17	2022/07/16
Power Sensor	Agilent	U2021XA	MY5365004	2021/07/17	2022/07/16
Test Control Unit	Tonscend	JS0806-1	178060067	2021/07/17	2022/07/16
Automated filter bank	Tonscend	JS0806-F	19F8060177	2021/07/17	2022/07/16
EMI Test Software	Tonscend	JS1120-1	Ver 2.6.8.0518	/	/
EMI Test Software	Tonscend	JS1120-3	Ver 2.5.77.0418	/	/
EMI Test Software	Tonscend	JS32-CE	Ver 2.5	/	/
EMI Test Software	Tonscend	JS32-RE	Ver 2.5.1.8	/	/

Note: 1. The Cal.Interval was one year.

4. TEST CONDITIONS AND RESULTS

4.1. AC Power Conducted Emission

TEST CONFIGURATION

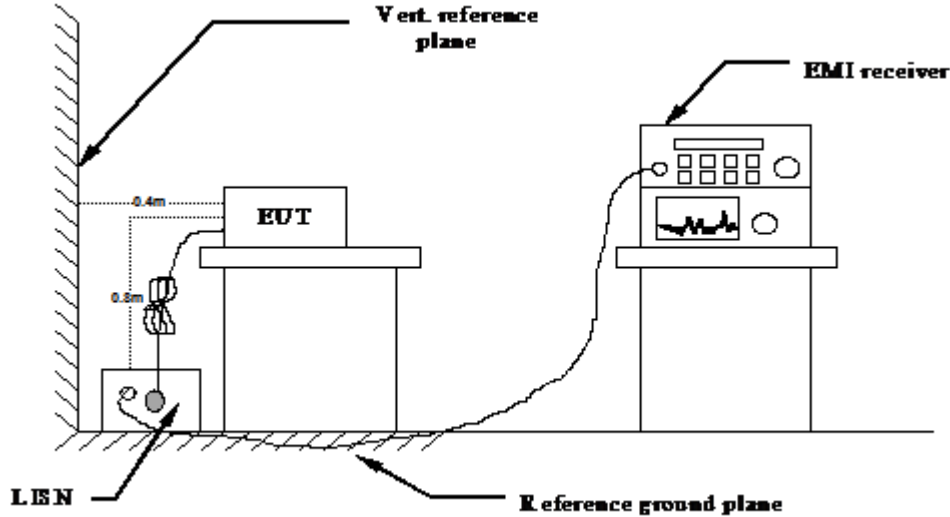

TEST PROCEDURE

- 1 The equipment was set up as per the test configuration to simulate typical actual usage per the user's manual. The EUT is a tabletop system, a wooden table with a height of 0.8 meters is used and is placed on the ground plane as per ANSI C63.10-2013.
- 2 Support equipment, if needed, was placed as per ANSI C63.10-2013
- 3 All I/O cables were positioned to simulate typical actual usage as per ANSI C63.10-2013
- 4 The EUT received DC 5V power, the adapter received AC120V/60Hz or AC 240V/60Hz power through a Line Impedance Stabilization Network (LISN) which supplied power source and was grounded to the ground plane.
- 5 The EUT test program was started. Emissions were measured on each current carrying line of the EUT using a spectrum Analyzer / Receiver connected to the LISN powering the EUT. The LISN has two monitoring points: Line 1 (Hot Side) and Line 2 (Neutral Side). Two scans were taken: one with Line 1 connected to Analyzer / Receiver and Line 2 connected to a 50 ohm load; the second scan had Line 1 connected to a 50 ohm load and Line 2 connected to the Analyzer / Receiver.
- 6 Analyzer / Receiver scanned from 150 KHz to 30MHz for emissions in each of the test modes.
- 7 During the above scans, the emissions were maximized by cable manipulation.

AC Power Conducted Emission Limit

For intentional device, according to § 15.207(a) AC Power Conducted Emission Limits is as following :

Frequency range (MHz)	Limit (dBuV)	
	Quasi-peak	Average
0.15-0.5	66 to 56*	56 to 46*
0.5-5	56	46
5-30	60	50

* Decreases with the logarithm of the frequency.

TEST RESULTS

Remark: We measured Conducted Emission at OOK mode from 150 KHz to 30MHz in AC120V and the worst case was recorded.

Temperature	24.2°C	Humidity	54.2%
Test Engineer	Oliver Ou	Configurations	SRD

Adapter: TPA-46B050100UU

Power supply:	AC 120V/60Hz	Polarization	L
---------------	--------------	--------------	---

Test Graph

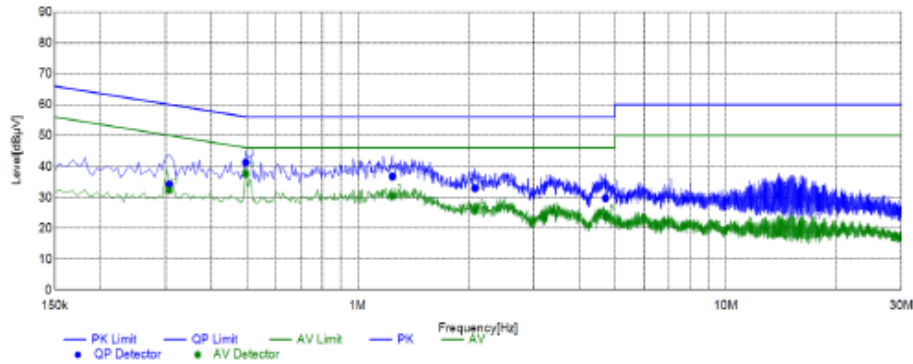

Final Data List												
NO.	Frequency [MHz]	QP Reading [dBµV]	AVG. Reading [dBµV]	Factor [dB]	QP Result [dBµV]	AVG. Result [dBµV]	QP Limit [dBµV]	AVG. Limit [dBµV]	QP Margin [dB]	AVG. Margin [dB]	Line	Remark
1	0.3070	24.83	22.93	9.42	34.25	32.35	60.05	50.05	25.80	17.70	L1	PASS
2	0.4971	31.89	28.22	9.40	41.29	37.62	56.05	46.05	14.76	8.43	L1	PASS
3	1.2416	27.39	20.92	9.39	36.78	30.31	56.00	46.00	19.22	15.69	L1	PASS
4	2.0854	23.65	16.32	9.36	33.01	25.68	56.00	46.00	22.99	20.32	L1	PASS
5	4.7156	20.37	14.38	9.39	29.76	23.77	56.00	46.00	26.24	22.23	L1	PASS
6	13.8806	21.60	9.08	9.17	30.77	18.25	60.00	50.00	29.23	31.75	L1	PASS

Note:1. Result (dBµV) = Reading (dBµV) + Factor (dB).
 2. Factor (dB) = Cable loss (dB) + LISN Factor (dB).

Power supply:	AC 120V/60Hz	Polarization	N
---------------	--------------	--------------	---

Test Graph

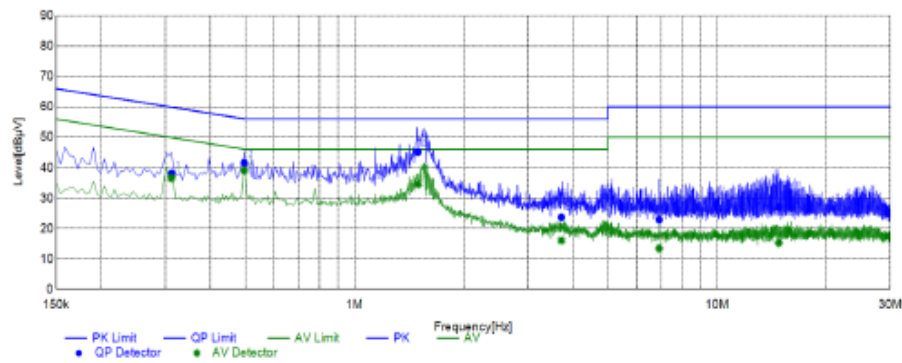

Final Data List												
NO.	Frequency [MHz]	QP Reading [dBµV]	AVG. Reading [dBµV]	Factor [dB]	QP Result [dBµV]	AVG. Result [dBµV]	QP Limit [dBµV]	AVG. Limit [dBµV]	QP Margin [dB]	AVG. Margin [dB]	Line	Remark
1	0.3128	28.62	27.16	9.46	38.08	36.62	59.89	49.89	21.81	13.27	N	PASS
2	0.4968	32.20	29.65	9.40	41.60	39.05	56.05	46.05	14.45	7.00	N	PASS
3	1.4967	35.79	25.25	9.36	45.15	34.81	56.00	46.00	10.85	11.39	N	PASS
4	3.7223	14.40	6.71	9.37	23.77	16.08	56.00	46.00	32.23	29.92	N	PASS
5	6.8230	13.60	4.19	9.31	22.91	13.90	60.00	50.00	37.09	36.50	N	PASS
6	14.7998	17.92	6.14	9.19	27.11	15.33	60.00	50.00	32.89	34.67	N	PASS

Note:1. Result (dBµV) = Reading (dBµV) + Factor (dB).
 2. Factor (dB) = Cable loss (dB) + LISN Factor (dB).

Adapter: GTA92-0501000US

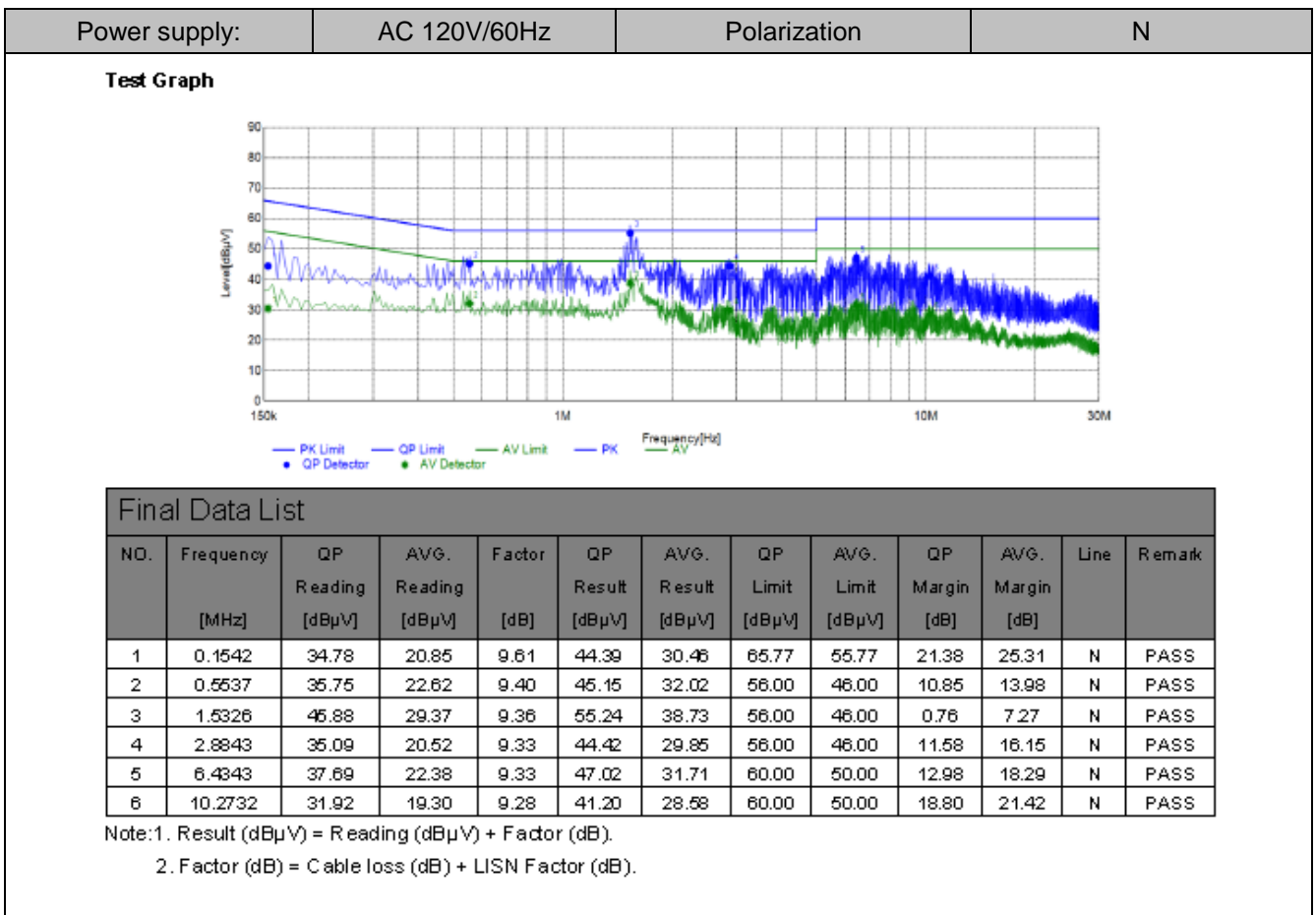
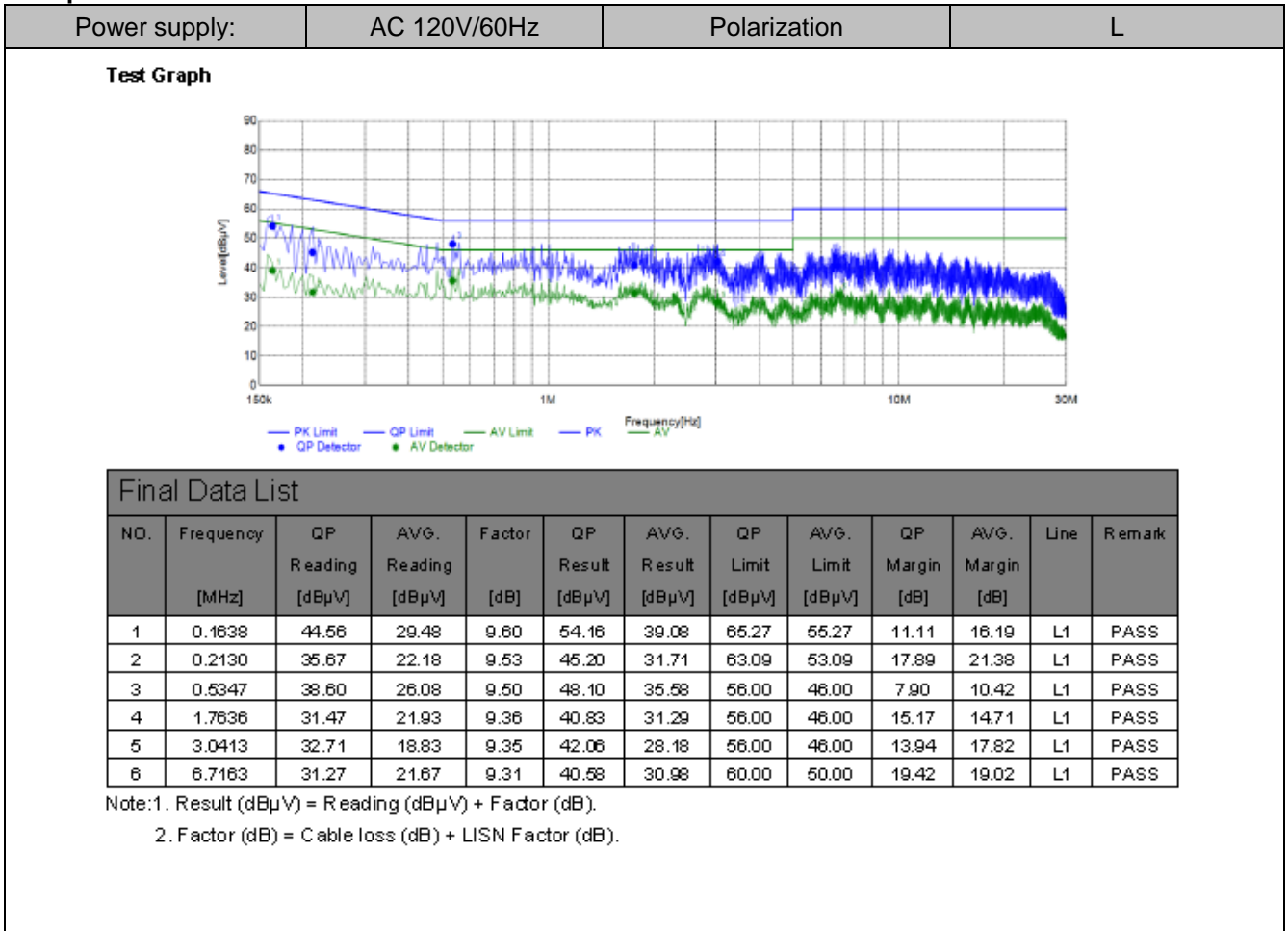

4.2. Transmitter Field Strength of Emissions

TEST CONFIGURATION

Frequency range 9 KHz – 30MHz



Frequency range 30MHz – 1000MHz

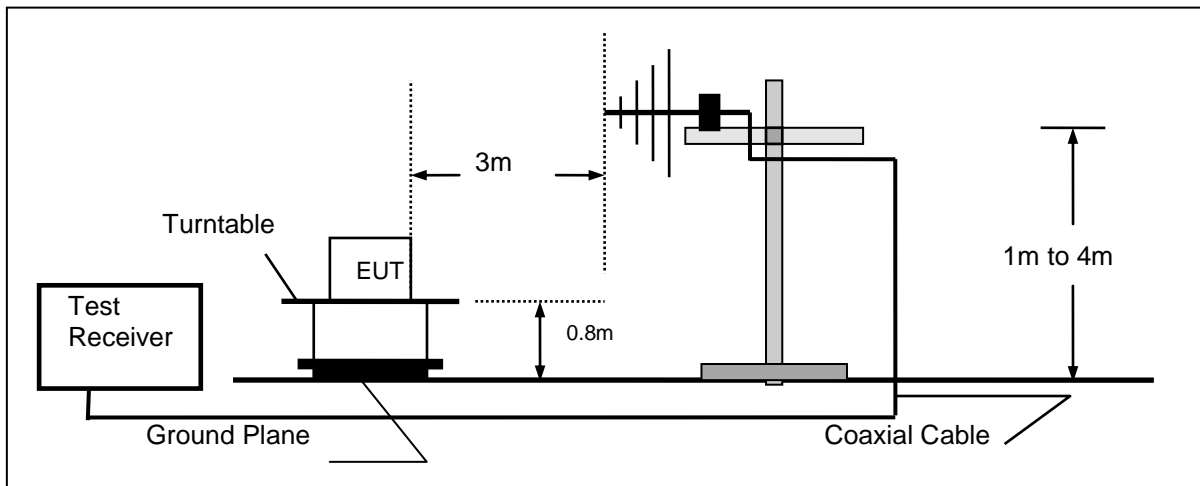

Frequency range above 1GHz-25GHz

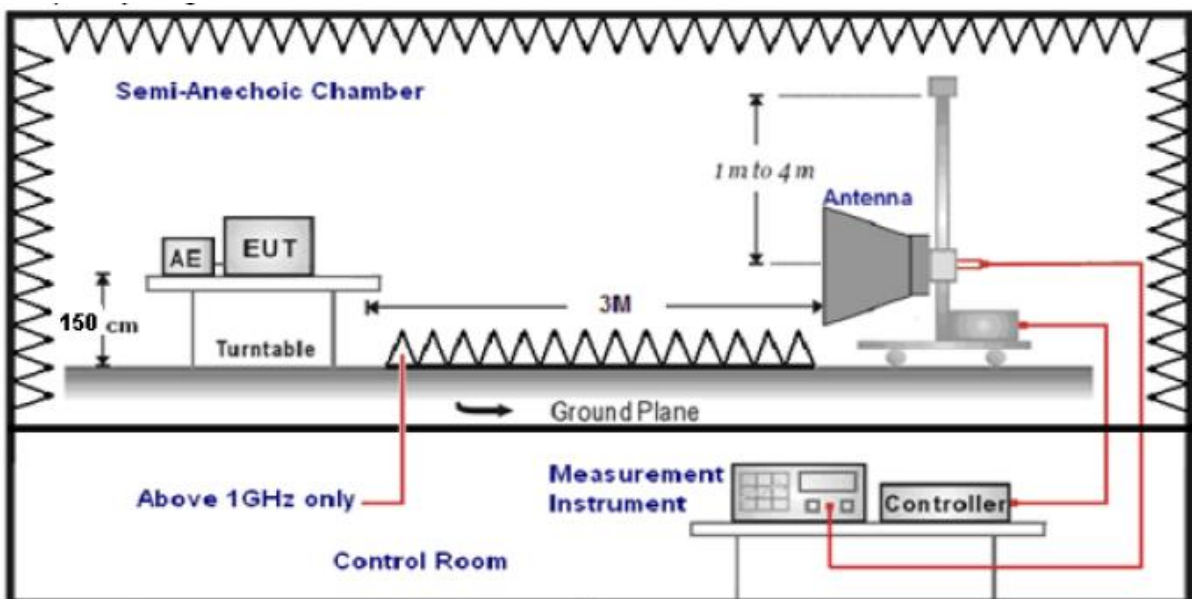

TEST PROCEDURE

1. The EUT was placed on a turn table which is 0.8m above ground plane when testing frequency range 9 KHz –1GHz;the EUT was placed on a turn table which is 1.5m above ground plane when testing frequency range 1GHz – 25GHz.
2. Maximum procedure was performed by raising the receiving antenna from 1m to 4m and rotating the turn table from 0°C to 360°C to acquire the highest emissions from EUT.
3. And also, each emission was to be maximized by changing the polarization of receiving antenna both horizontal and vertical.
4. Repeat above procedures until all frequency measurements have been completed.
5. Radiated emission test frequency band from 30MHz to 25GHz.
6. The distance between test antenna and EUT as following table states:

Test Frequency range	Test Antenna Type	Test Distance
9KHz-30MHz	Active Loop Antenna	3
30MHz-1GHz	Ultra-Broadband Antenna	3
1GHz-18GHz	Double Ridged Horn Antenna	3
18GHz-25GHz	Horn Antenna	1

7. Setting test receiver/spectrum as following table states:

Test Frequency range	Test Receiver/Spectrum Setting	Detector
9KHz-150KHz	RBW=200Hz/VBW=3KHz,Sweep time=Auto	QP
150KHz-30MHz	RBW=9KHz/VBW=100KHz,Sweep time=Auto	QP
30MHz-1GHz	RBW=120KHz/VBW=1000KHz,Sweep time=Auto	QP
1GHz-40GHz	Peak Value: RBW=1MHz/VBW=3MHz, Sweep time=Auto Average Value: RBW=1MHz/VBW=10Hz, Sweep time=Auto	Peak

Field Strength Calculation

The field strength is calculated by adding the Antenna Factor and Cable Factor and subtracting the Amplifier Gain and Duty Cycle Correction Factor(if any) from the measured reading. The basic equation with a sample calculation is as follows:

$$FS = RA + AF + CL - AG$$

Where FS = Field Strength	CL = Cable Attenuation Factor (Cable Loss)
RA = Reading Amplitude	AG = Amplifier Gain
AF = Antenna Factor	

$$\text{Transd}=AF +CL-AG$$

RADIATION LIMIT

The pre-test have done for the EUT in three axes and found the worst emission at position shown in test setup photos.

Frequency (MHz)	Distance (Meters)	Radiated (dBµV/m)	Radiated (µV/m)
0.009-0.49	3	$20\log(2400/F(\text{KHz}))+40\log(300/3)$	$2400/F(\text{KHz})$
0.49-1.705	3	$20\log(24000/F(\text{KHz}))+ 40\log(30/3)$	$24000/F(\text{KHz})$
1.705-30	3	$20\log(30)+ 40\log(30/3)$	30
30-88	3	40.0	100
88-216	3	43.5	150
216-960	3	46.0	200
Above 960	3	54.0	500

According to §15.231 (b): In addition to the provisions of §15.205, the field strength of emissions from intentional radiators operated under this section shall not exceed the following:

Frequencies(MHz)	Field Strength (microvolts/meter)	Field Strength of spurious emissions(microvolts/meter)
40.66-40.70	2,250	225
70-130	1,250	125
130-174	¹ 1,250 to 3,750	¹ 125 to 375
174-260	3,750	375
260-470	¹ 3,750 to 12,500	¹ 375 to 1,250
Above 470	12,500	1,250

¹Linear interpolations.

[Where F is the frequency in MHz, the formulas for calculating the maximum permitted fundamental field strengths are as follows: for the band 130-174 MHz, $\mu\text{V}/\text{m}$ at 3 meters = $56.81818(F) - 6136.3636$; for the band 260-470 MHz, $\mu\text{V}/\text{m}$ at 3 meters = $41.6667(F) - 7083.3333$. The maximum permitted unwanted emission level is 20 dB below the maximum permitted fundamental level.]

(1) The above field strength limits are specified at a distance of 3 meters. The tighter limits apply at the band edges.

(2) Intentional radiators operating under the provisions of this section shall demonstrate compliance with the limits on the field strength of emissions, as shown in the above table, based on the average value of the measured emissions. As an alternative, compliance with the limits in the above table may be based on the use of measurement instrumentation with a CISPR quasi-peak detector. The specific method of measurement employed shall be specified in the application for equipment authorization. If average emission measurements are employed, the provisions in §15.35 for averaging pulsed emissions and for limiting peak emissions apply. Further, compliance with the provisions of §15.205 shall be demonstrated using the measurement instrumentation specified in that section.

(3) The limits on the field strength of the spurious emissions in the above table are based on the fundamental frequency of the intentional radiator. Spurious emissions shall be attenuated to the average (or, alternatively, CISPR quasi-peak) limits shown in this table or to the general limits shown in §15.209, whichever limit permits a higher field strength.

15.205 (a) Except as shown in paragraph (d) of this section, only spurious emissions are permitted in any of the frequency bands listed below:

MHz	MHz	MHz	GHz
0.090-0.110	16.42-16.423	399.9-410	4.5-5.15
\1\ 0.495-0.505	16.69475-16.69525	608-614	5.35-5.46
2.1735-2.1905	16.80425-16.80475	960-1240	7.25-7.75
4.125-4.128	25.5-25.67	1300-1427	8.025-8.5
4.17725-4.17775	37.5-38.25	1435-1626.5	9.0-9.2
4.20725-4.20775	73-74.6	1645.5-1646.5	9.3-9.5
6.215-6.218	74.8-75.2	1660-1710	10.6-12.7
6.26775-6.26825	108-121.94	1718.8-1722.2	13.25-13.4
6.31175-6.31225	123-138	2200-2300	14.47-14.5
8.291-8.294	149.9-150.05	2310-2390	15.35-16.2
8.362-8.366	156.52475-156.52525	2483.5-2500	17.7-21.4
8.37625-8.38675	156.7-156.9	2690-2900	22.01-23.12
8.41425-8.41475	162.0125-167.17	3260-3267	23.6-24.0
12.29-12.293	167.72-173.2	3332-3339	31.2-31.8
12.51975-12.52025	240-285	3345.8-3358	36.43-36.5
12.57675-12.57725	322-335.4	3600-4400	(\2)
13.36-13.41			

\1\ Until February 1, 1999, this restricted band shall be 0.490-0.510 MHz.

\2\ Above 38.6

TEST RESULTS

Remark: We measured Radiated Emission at OOK mode from 30 MHz to 25GHz in AC120V and the worst case was recorded.

Temperature	25°C	Humidity	60%
Test Engineer	Oliver Ou	Configurations	SRD

For 9 KHz~30MHz

Freq. (MHz)	Level (dBuV)	Over Limit (dB)	Over Limit (dBuV)	Remark
-	-	-	-	See Note

Note:

The low frequency, which started from 9 KHz to 30 MHz, was pre-scan and the result was 20dB lower than the limit line per 15.31(o) was not reported.

Distance extrapolation factor = $40 \log(\text{specific distance} / \text{test distance})$ (dB);

Limit line = specific limits (dBuV) + distance extrapolation factor.

For 30MHz to 1000MHz

Adapter: TPA-46B050100UU

Fundamental and Harmonics Average Result						
Frequency (MHz)	Peak Level (dBμV/m)	AV Factor(dBμV/m) (see Section 4.5)	Average Level (dBμV/m)	Limit(dBμV/m) (average)	Margin(dB)	Conclusion
433.82	75.96	-7.77	68.19	80.80	12.61	PASS

Frequency (MHz)	Pol.	Measure Result(AV, dBuV/m)	ERP(dBm)	Limit (dBuV/m)	Result
SRD	H	68.19	-26.97	80.80	Pass

Horizontal

Test Graph

NO.	Frequency [MHz]	Reading [dBμV/m]	Factor [dB]	Result [dBμV/m]	Limit [dBμV/m]	Margin [dB]	Height [cm]	Angle [°]	Detector	Polarity	Remark
1	91.1100	34.07	-10.15	23.92	43.50	19.58	100	346	PK	Horizontal	PASS
2	167.7400	49.44	-11.51	37.93	43.50	5.57	100	292	PK	Horizontal	PASS
3	282.6850	40.25	-7.84	32.41	46.00	13.59	100	322	PK	Horizontal	PASS
4	368.0450	35.06	-6.12	28.94	46.00	17.06	100	286	PK	Horizontal	PASS
5	434.0050	80.31	-4.35	75.96	46.00	-29.96	100	53	PK	Horizontal	FAIL
6	552.3450	37.61	-2.92	34.69	46.00	11.31	100	270	PK	Horizontal	PASS
7	792.4200	31.86	1.14	33.00	46.00	13.00	100	300	PK	Horizontal	PASS

Note:1. Result (dBμV/m) = Reading(dBμV/m) + Factor (dB) .

2. Factor (dB) = Antenna Factor (dB/m) + Cable loss (dB) - Pre Amplifier gain (dB).

Fundamental and Harmonics Average Result						
Frequency (MHz)	Peak Level (dBμV/m)	AV Factor(dBμV/m) (see Section 4.5)	Average Level (dBμV/m)	Limit(dBμV/m) (average)	Margin(dB)	Conclusion
434.01	75.66	-7.77	67.89	80.80	12.91	PASS

Frequency (MHz)	Pol.	Measure Result(AV, dBuV/m)	ERP(dBm)	Limit (dBuV/m)	Result
SRD	V	67.89	-27.27	80.80	Pass

Vertical

Test Graph

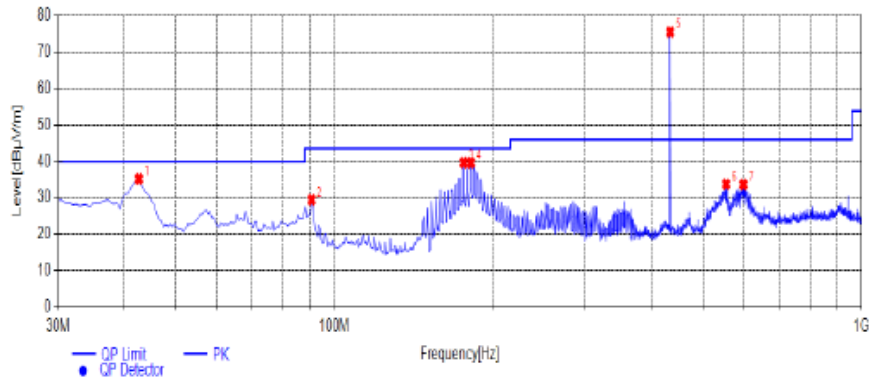

Suspected List

NO.	Frequency [MHz]	Reading [dBμV/m]	Factor [dB]	Result [dBμV/m]	Limit [dBμV/m]	Margin [dB]	Height [cm]	Angle [°]	Detector	Polarity	Remark
1	42.6100	42.19	-6.99	35.20	40.00	4.80	100	317	PK	Vertical	PASS
2	90.6250	39.66	-10.26	29.40	43.50	14.10	100	41	PK	Vertical	PASS
3	175.9850	50.50	-10.81	39.69	43.50	3.81	100	244	PK	Vertical	PASS
4	181.8050	50.75	-11.10	39.65	43.50	3.85	100	230	PK	Vertical	PASS
5	434.0050	80.01	-4.35	75.66	46.00	-29.66	100	282	PK	Vertical	FAIL
6	554.7700	36.65	-2.91	33.74	46.00	12.26	100	27	PK	Vertical	PASS
7	597.9350	35.33	-1.68	33.65	46.00	12.35	100	30	PK	Vertical	PASS

Note:1. Result (dBμV/m) = Reading(dBμV/m) + Factor (dB) .

2. Factor (dB) = Antenna Factor (dB/m) + Cable loss (dB) - Pre Amplifier gain (dB).

Adapter: GTA92-0501000US

Fundamental and Harmonics Average Result						
Frequency (MHz)	Peak Level (dBμV/m)	AV Factor(dBμV/m) (see Section 4.5)	Average Level (dBμV/m)	Limit(dBμV/m) (average)	Margin(dB)	Conclusion
434.01	75.00	-7.77	67.23	80.80	13.57	PASS

Frequency (MHz)	Pol.	Measure Result(AV, dBuV/m)	ERP(dBm)	Limit (dBuV/m)	Result
434.01	H	67.23	-27.93	80.80	Pass

Horizontal

Test Graph

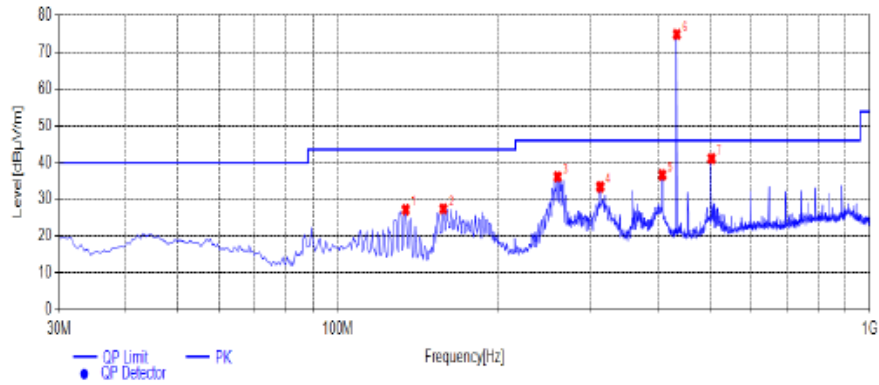

Suspected List											
N.O.	Frequency [MHz]	Reading [dBμV/m]	Factor [dB]	Result [dBμV/m]	Limit [dBμV/m]	Margin [dB]	Height [cm]	Angle [°]	Detector	Polarity	Remark
1	134.2750	39.48	-12.35	27.13	43.50	16.37	100	174	PK	Horizontal	PASS
2	158.0400	39.39	-12.02	27.37	43.50	16.13	100	111	PK	Horizontal	PASS
3	259.4050	44.06	-7.89	36.17	46.00	9.83	100	307	PK	Horizontal	PASS
4	311.7850	40.55	-7.16	33.39	46.00	12.61	100	106	PK	Horizontal	PASS
5	407.8150	41.58	-4.89	36.69	46.00	9.31	100	81	PK	Horizontal	PASS
6	434.0050	79.35	-4.35	75.00	46.00	-29.00	100	132	PK	Horizontal	FAIL
7	504.3300	44.51	-3.37	41.14	46.00	4.86	100	67	PK	Horizontal	PASS

Note:1. Result (dBμV/m) = Reading(dBμV/m) + Factor (dB) .

2. Factor (dB) = Antenna Factor (dB/m) + Cable loss (dB) - Pre Amplifier gain (dB).

Fundamental and Harmonics Average Result						
Frequency (MHz)	Peak Level (dBμV/m)	AV Factor(dBμV/m) (see Section 4.5)	Average Level (dBμV/m)	Limit(dBμV/m) (average)	Margin(dB)	Conclusion
434.01	75.36	-7.77	67.59	80.80	13.21	PASS

Frequency (MHz)	Pol.	Measure Result(AV, dBuV/m)	ERP(dBm)	Limit (dBuV/m)	Result
434.01	V	67.59	-27.57	80.80	Pass

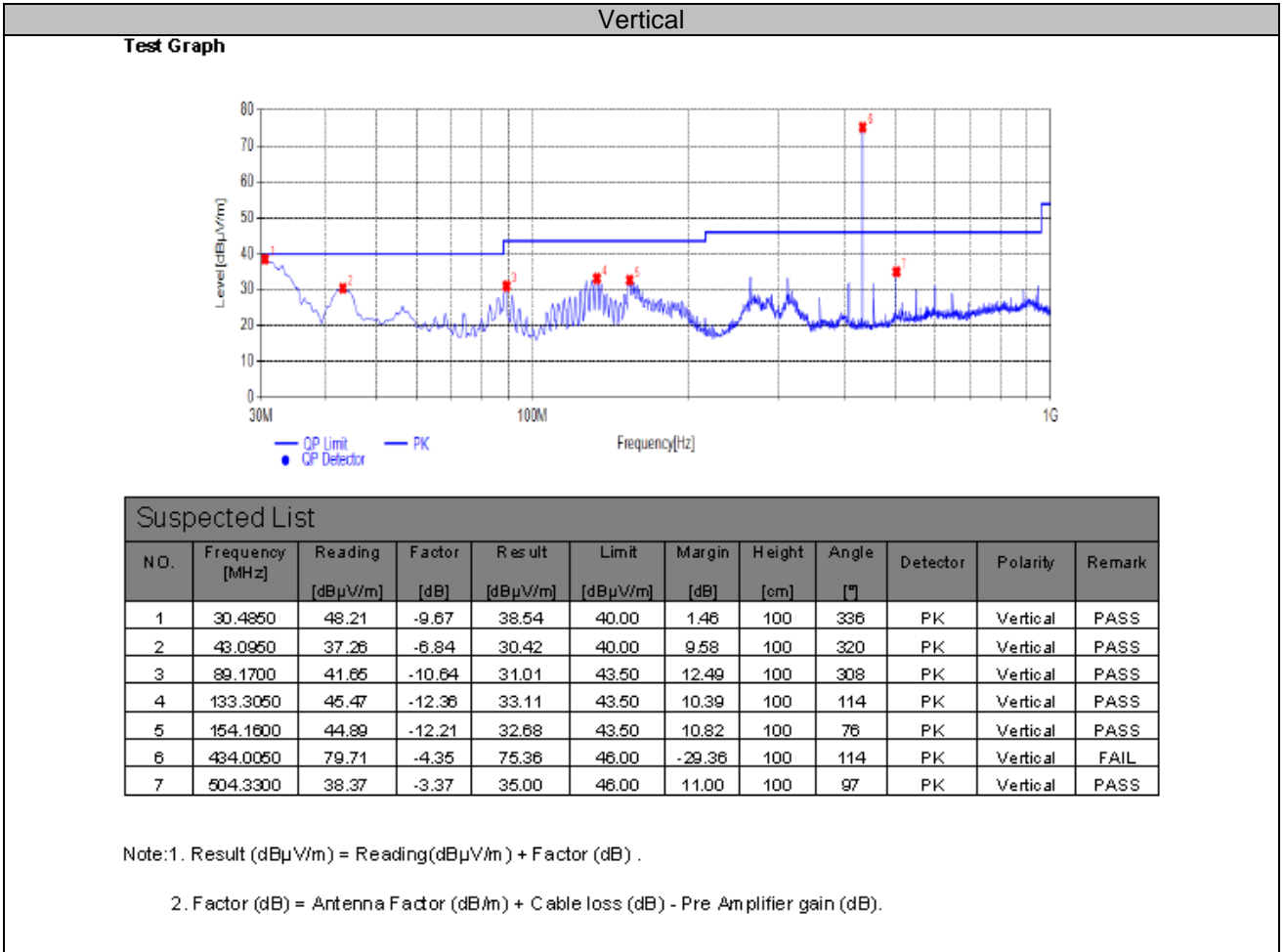

Notes:

- 1). Measured= Reading- Pre. Fac.+ Ant. Fac.+ Cab. Loss
- 2). Margin = Measured- Limit
- 3). Average values = Peak values + DC factor = Peak values – 0
- 4).point 4 is the fundamental, Limit is 100.80 dBμV/m, 6 is the second harmonic, Limit is 80.80 dBμV/m
- 5).ERP = EMeas + 20log (dMeas) -104.7
 ERP: is the equivalent isotropically radiated power, in dBm
 EMeas: is the field strength of the emission at the measurement distance, in dBuV/m
 dMeas: is the measurement distance, in m

For 1GHz to 5GHz

Peak Value				
Frequency (MHz)	Level (dBuV/m)	Limit Line (dBuV/m)	Margin (dB)	Polarization
1299.59	52.25	74.00	-21.75	Horizontal
1733.63	52.05	74.00	-21.95	Horizontal
1299.12	55.95	74.00	-18.05	Vertical
1733.49	53.07	74.00	-20.93	Vertical

Average Value:						
Frequency (MHz)	Level (dBuV/m)	Duty cycle factor	Average value (dBuV/m)	Limit Line (dBuV/m)	Margin (dB)	Polarization
1299.59	52.25	-7.77	44.48	54.00	-9.52	Horizontal
1733.63	52.05	-7.77	44.28	54.00	-9.72	Horizontal
1299.12	55.95	-7.77	48.18	54.00	-5.82	Vertical
1733.49	53.07	-7.77	45.30	54.00	-8.70	Vertical

Notes:

- 1). Measuring frequencies from 9 KHz~10th harmonic (ex. 5GHz), No emission found between lowest internal used/generated frequency to 30MHz.
- 2). Radiated emissions measured in frequency range from 9 KHz~10th harmonic (ex. 5GHz) were made with an instrument using Peak detector mode.
- 3). Data of measurement within this frequency range shown " --- " in the table above means the reading of emissions are attenuated more than 20dB below the permissible limits or the field strength is too small to be measured.

4.4. 20dB Bandwidth Emissions

TEST CONFIGURATION

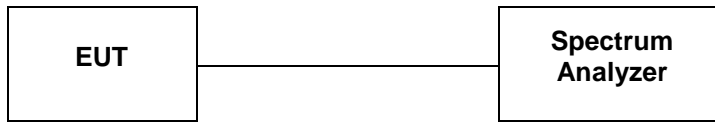

TEST PROCEDURE

With the EUT’s antenna attached, the EUT’s 20dB Bandwidth power was received by the test antenna which was connected to the spectrum analyzer with the START and STOP frequencies set to the EUT’s operation band.

LIMIT

The bandwidth of the emission shall be no wider than 0.25% of the center frequency for devices operating above 70 MHz and below 900 MHz. Bandwidth is determined at the points 20 dB down from the modulated carrier.

TEST RESULTS

Temperature	22.9°C	Humidity	53.2%
Test Engineer	Oliver Ou	Configurations	SRD

Transmit Frequency (MHz)	Limit (kHz)	20dB Bandwidth (kHz)	Result
433.92	1084.8	62.66	PASS
Maximum allowed bandwidth:	<input checked="" type="checkbox"/> 0.25% of the centre operating frequency <input type="checkbox"/> 0.5% of the centre operating frequency		
RBW:	<input checked="" type="checkbox"/> 10kHz <input type="checkbox"/> 100kHz <input type="checkbox"/> other 30kHz		
VBW:	<input checked="" type="checkbox"/> 30kHz <input type="checkbox"/> 300kHz <input type="checkbox"/> other 100kHz		

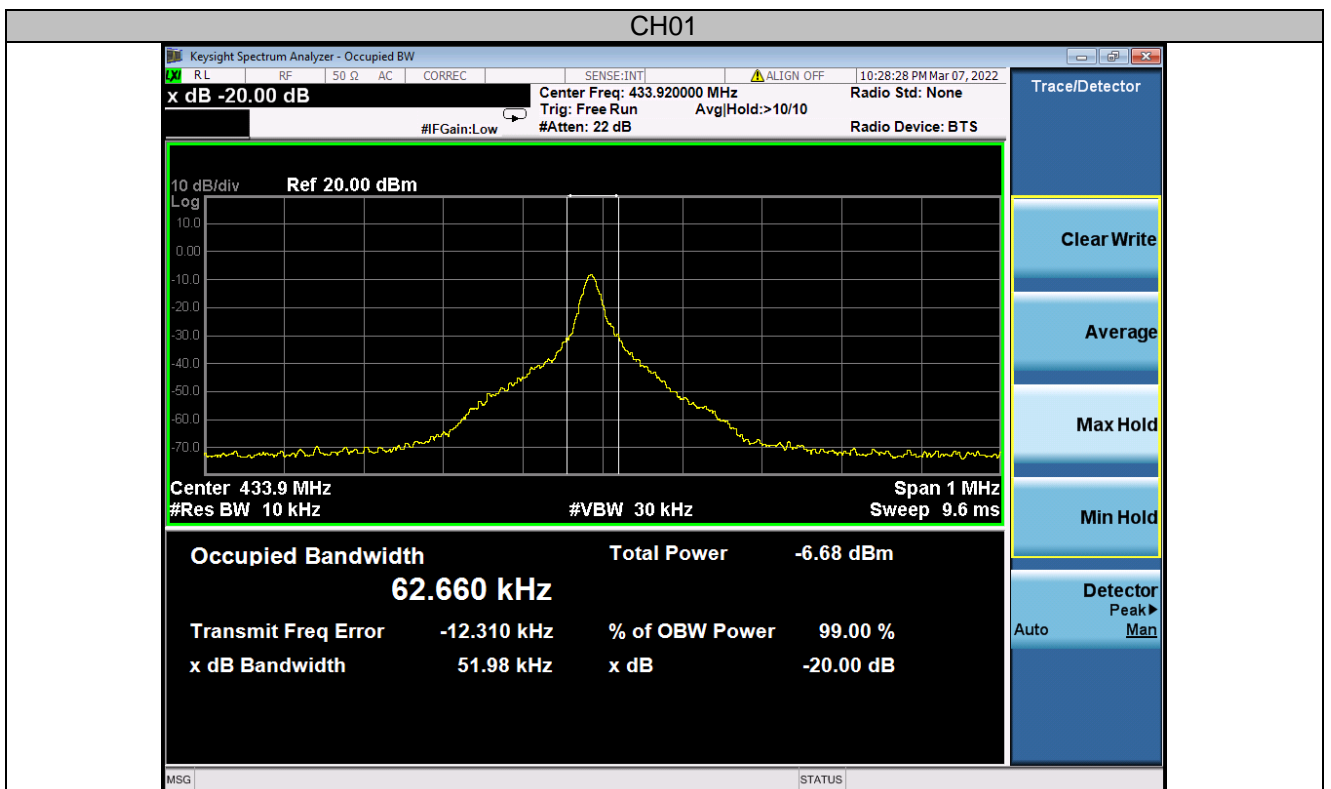

4.5. Duty cycle

TEST REQUIREMENT

In any 100 kHz bandwidth outside the frequency band in which the spread spectrum or digitally modulated intentional radiator is operating, the radio frequency power that is produced by the intentional radiator shall be at least 20 dB below that in the 100 kHz bandwidth within the band that contains the highest level of the desired power, based on either an RF conducted or a radiated measurement, provided the transmitter demonstrates compliance with the peak conducted power limits. If the transmitter complies with the conducted power limits based on the use of RMS averaging over a time interval, as permitted under paragraph (b)(3) of this section, the attenuation required under this paragraph shall be 30 dB instead of 20 dB. Attenuation below the general limits specified in §15.209(a) is not required. In addition, radiated emissions which fall in the restricted bands, as defined in §15.205(a), must also comply with the radiated emission limits specified in §15.209(a) (see §15.205(c)).

TEST CONFIGURATION

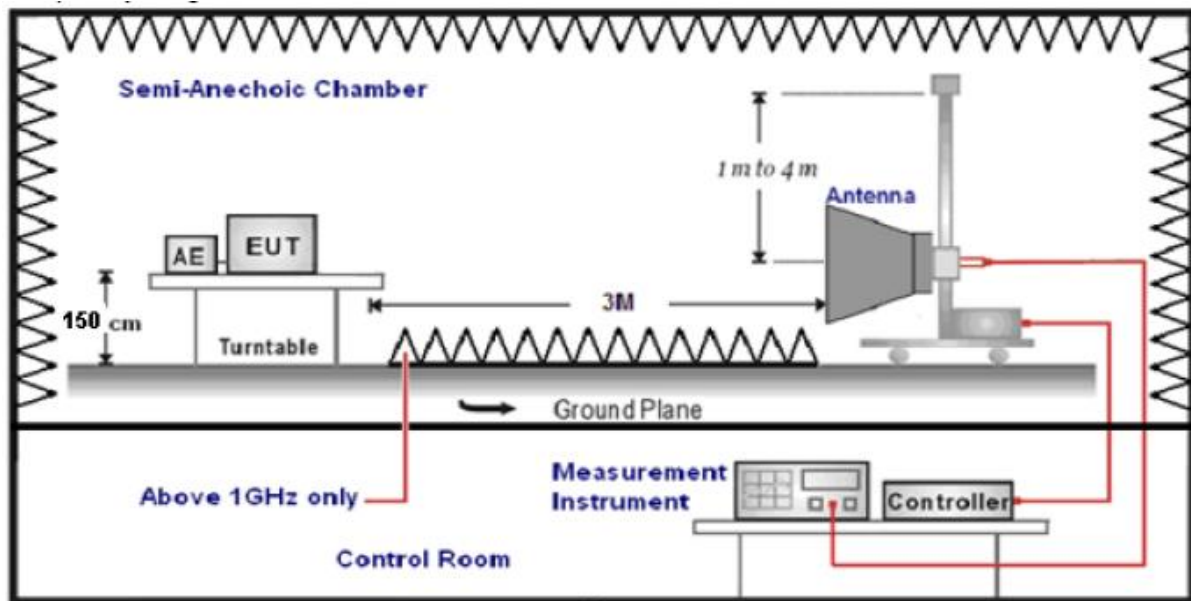

TEST PROCEDURE

1. Place the EUT on the table and set it in transmitting mode.
2. Remove the antenna from the EUT and then connect a low loss RF cable from the antenna port to the spectrum analyser.
3. Set centre frequency of spectrum analyser = operating frequency.
4. Set the spectrum analyser as RBW=1MHz, VBW=1MHz, Span=0Hz, Adjust Sweep=100ms to obtain the "worst-case" pulse on time
5. Repeat above procedures until all frequency measured was complete.

LIMIT

No dedicated limit specified in the Rules.

TEST RESULTS

Ton = (Ton₁* Numbers of pulse during)+ (Ton₂* Numbers of pulse during)=1.27*4+0.44*41= 23.12 (ms)
 Tp = 56.6 (ms)
 The duty cycle = 23.12/56.6=40.85%
 Average Correction Factory = 20*log (Ton/Tp) =20*log (0.409) = -7.77dB

Temperature	22.9°C	Humidity	53.2%
Test Engineer	Oliver Ou	Configurations	SRD

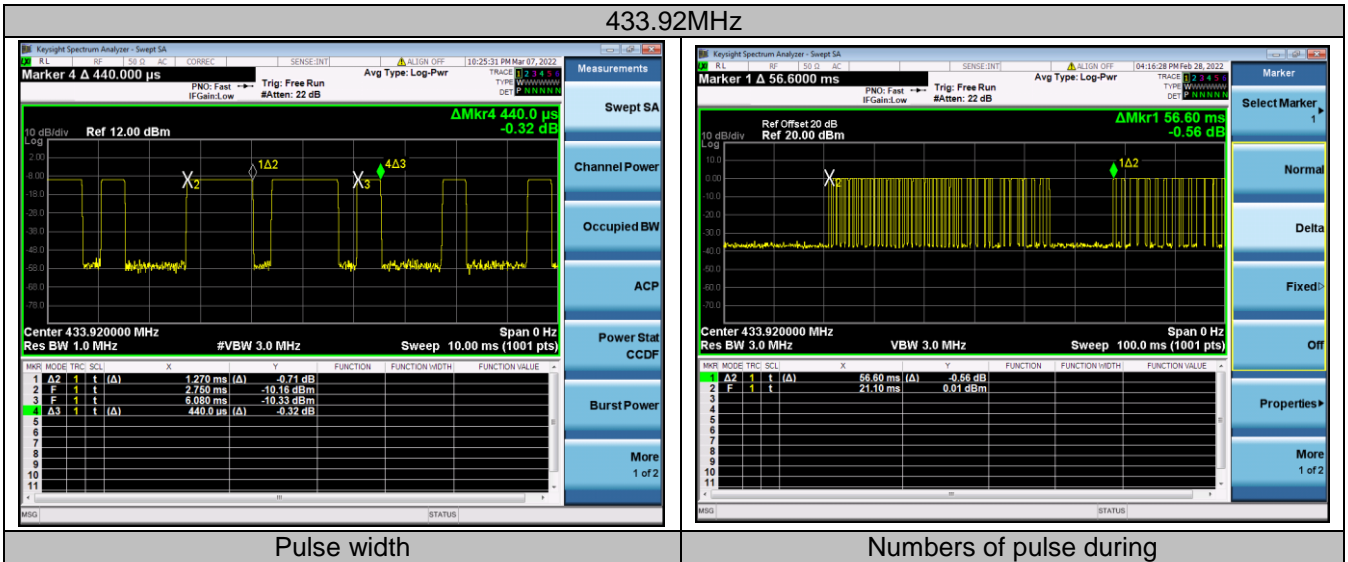

4.6. Antenna Requirement

Standard Applicable

According to § 15.203 & RSS-Gen, An intentional radiator shall be designed to ensure that no antenna other than that furnished by the responsible party shall be used with the device. The use of a permanently attached antenna or of an antenna that uses a unique coupling to the intentional radiator shall be considered sufficient to comply with the provisions of this section.

Test Result

The antenna used for this product is FPC Antenna and that no antenna other than that furnished by the responsible party shall be used with the device, the maximum peak gain of the transmit antenna is only -8.89dBi.

Reference to the **Internal photos**.

5. TEST SETUP PHOTOS OF THE EUT

Reference to the test report No. GTS20220221011-1-10.

6. EXTERNAL AND INTERNAL PHOTOS OF THE EUT

Reference to the test report No. GTS20220221011-1-10.

.....**End of Report**.....