



Translation of the original operating instructions

Sensor 01

Type: Liquidtool sensor

Product number: LTS-1-01-XXXXXX

Year of manufacture: 2021



Follow these instructions for proper and safe use.
Keep for future reference.

CONTENTS

Contents	3
Purpose of the operating instructions	5
Orientation in the operating instructions	5
1 Identification	7
1.1 Product identification	7
1.2 Manufacturer information	7
1.3 FCC Compliance.....	7
1.4 Rating plate	8
1.5 Declaration of Conformity.....	9
2 Basic safety instructions	10
2.1 Duty of care of the operating company	10
2.2 General safety at work	10
2.2.1 Personnel qualification.....	10
2.2.2 Approved personnel.....	11
2.3 Residual risks.....	11
2.3.1 Danger from electrical energy.....	11
2.3.2 Danger from magnetism	11
2.3.3 Danger from leaks and hose lines.....	12
2.3.4 Hazards from coolants	13
2.4 Safety instructions of the sensor	14
2.5 Emergency information	14
3 Description, structure and function	15
3.1 Intended use	15
3.2 Reasonably foreseeable misuse	15
3.3 Conversions and modifications	15
3.4 Specifications.....	15
3.5 Location requirements.....	16
3.6 Design	16
3.7 Functional and system description	17
3.8 LED status indicator	17
3.9 Interfaces	18
4 Transportation, installation and storage	19
4.1 Introductory safety notes.....	19
4.2 Packaging	19
4.3 Transportation.....	19
4.4 Delivery	20
4.4.1 Scope of delivery	20
4.4.2 Checking for transportation damage	20
4.5 Downloading the app	21
4.6 Storage.....	21
5 Startup	22
5.1 Introductory safety notes.....	22
5.2 Installation	22
5.3 Identification of the machine tool.....	23
5.4 Information for the connection of the sensor	23
5.5 Connection	24
6 Operation	28



6.1	Introductory safety notes	28
6.2	Switching on the sensor	28
6.3	Switching off the sensor	28
6.4	Operation	28
7	Taking out of operation	29
7.1	Introductory safety notes	29
7.2	Remove the identification of the machine tool	29
7.3	Removal	30
7.4	Cleaning	32
8	Service and maintenance	32
8.1	Troubleshooting	32
9	Disposal	33
9.1	Introductory safety notes	33
9.2	Removal	33
9.3	Proper and environmentally compatible disposal	33
9.4	Disposal points	33

PURPOSE OF THE OPERATING INSTRUCTIONS

Ensure that you have read the operating instructions before you operate the sensor for the first time or when you are instructed to carry out other work on the sensor.

Using and handling the sensor described below is not self-evident. It is explained in detail in the accompanying technical documentation.

Take special notice of the chapter "2 Basic safety instructions".

Operating instructions

The operating instructions are intended to help you to use the sensor properly, efficiently and safely. Therefore, read the following chapters carefully and attentively. If necessary, always look up facts that are crucial for you.

Residual risks

The operating instructions inform and warn you of residual risks against which risk reduction by design and protective measures is not or not fully effective.

ORIENTATION IN THE OPERATING INSTRUCTIONS

Representation of general information icons

These operating instructions contain the following general information icons to guide you, the reader, through the operating instructions and to provide you with important information.

Pictogram	Meaning
	Caution - possible material damage This pictogram tells you that there is a risk of material damage to the sensor during an action if the action specifications are not observed and carried out correctly.
	Important information This pictogram identifies important additional information that includes a warning of a danger.
	Personnel qualification This pictogram tells you which personnel (target group) are allowed to perform the actions in the respective chapter.
	Instruction for action This pictogram identifies an instruction for action. It always precedes an active action that is to be performed by the user.

Tab. 1: General pictograms and their meaning

Icons used in operating instructions

Warning icons warn of dangerous areas, risks and obstacles.



Warning of dangerous area



Warning of magnetic field



Warning of crushing hazard



Warning of tripping hazard



Warning of flammable substances



Warning of slipping hazard



Warning of harmful substances



Warning of environmental damage

Mandatory icons are used for the prevention of accidents at the workplace



General mandatory icon



Wear safety shoes



Wear protective gloves



Wear adequate working clothes



Wear protective goggles



Read instructions

Prohibition icons contribute to more safety.



General prohibition icon



Prohibition for persons with cardiac pacemaker



Prohibition of food and beverages at the workplace



Prohibition of naked flames and ignition sources

1 IDENTIFICATION

1.1 Product identification

Sensor 01
Sensor type: Liquidtool sensor
Product number: LTS-1-01-XXXXXX
Year of manufacture: 2021

1.2 Manufacturer information

Company headquarters	Liquidtool Systems Inc.
	Winterseistrasse 22
	3415Hasle-Rüegsau
	Switzerland
E-mail:	info@liquidtool.com
Internet:	www.liquidtool.com

Tab. 2: Manufacturer information

1.3 FCC Compliance

Changes or modifications not expressly approved by the party responsible for compliance could void the user's authority to operate the equipment.

This is a mobile device to be used in such a way that a separation distance of at least 20 centimeters is normally maintained between the RF source's radiating structure(s) and the body of the user or nearby persons.

1.4 Rating plate

The rating plate and the product information on the product clearly identify the sensor.
The rating plate of the sensor sits on the bottom of the sensor.

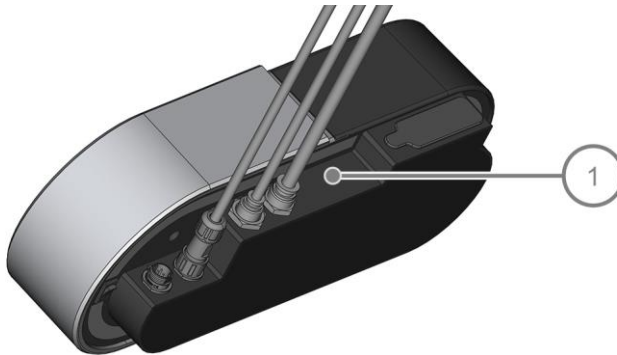

Fig. 1: Place of attachment

- 1 Rating plate



Fig. 2: Rating plate

- 2 For EU member states only: Disposal instructions for batteries and rechargeable batteries
- 3 For EU member states only: Disposal instructions for electrical appliances
- 4 Specifications of the year of manufacture
- 5 Company address

1.5 Declaration of Conformity

EC Declaration of Conformity

The manufacturer / distributor

Liquid Tool Systems AG
Winterseistrasse 22
3415 Hasle-Rüegsau
Switzerland

hereby declares that the following product

Product designation: Sensor for fluids
Model designation: Sensor 01
Type designation: Liquidtool sensor
Serial number: LTS-1-01-XXXXXX
Year of manufacture: 2021
Description:
Sensor to measure temperature and concentration of cooling lubricants

complies with all relevant provisions of the applied legal regulations (hereinafter) - including their amendments in force at the time of the declaration. The manufacturer bears the sole responsibility for issuing this declaration of conformity. This declaration refers only to the machine in the condition in which it was placed on the market; parts and/or interventions subsequently fitted by the end user are not taken into account.

The following legislation has been applied:

Machinery Directive 2006/42/EC
Radio Equipment Directive 2014/53/EC
RoHS Directive 2011/65/EC

The protection objectives of the following other legal regulations were complied with:
Low Voltage Directive 2014/35/EC

The following harmonized standards have been applied:

EN 60204-1:2006/AC:2010 Safety of machinery - Electrical equipment of machines - Part 1: General requirements (IEC 60204-1:2005, modified)
EN ISO 12100:2010 Safety of machinery - General principles for design - Risk assessment and risk reduction (ISO 12100:2010)
EN ISO 19353:2016 Safety of machinery - Fire prevention and fire protection (ISO 19353:2015)
EN ISO 20607:2019 Safety of machinery - Instruction handbook - General drafting principles (ISO 20607:2019)

Name and address of the person authorized to compile the technical documentation:

Liquid Tool Systems AG
Winterseistrasse 22
3415 Hasle-Rüegsau
Switzerland

Place: Hasle-Rüegsau
Date: March 19, 2021



Manfred Schneeberger
Head of Research and Development

Fig. 3: Declaration of Conformity

2 BASIC SAFETY INSTRUCTIONS

2.1 Duty of care of the operating company

Technical state of the sensor

The following requirements are placed on the technical state of the sensor, and must be ensured by the operating company:

- The sensor may only be used as intended
- The sensor must always be checked for its faultless technical condition before it is switched on
- The functioning of the safety devices must be checked at regular intervals
- The safety and warning labels attached to the sensor must never be removed. They must be checked at regular intervals to ensure that they are legible. They must be replaced if necessary.
- No unauthorized conversions, manipulations or changes to the sensor are allowed
- The operating instructions must always be available in a legible condition and complete at the place where the sensor is used. This also applies to the instructions from suppliers.



2.2 General safety at work

2.2.1 Personnel qualification



Important information on personnel qualification

Only instructed, trained and authorized persons are allowed to carry out activities on the sensor.

 WARNING	
	<p>Danger from insufficient personnel qualification</p> <p>There is a risk of serious injury and considerable material damage if unqualified personnel are in the danger zone or carry out work on the sensor.</p> <ul style="list-style-type: none"> ➤ The operating personnel must have the specified qualifications. ➤ Unqualified personnel must be kept away from the danger zone.

Trained, instructed operating personnel

A person is considered to be trained/instructed if he/she has been informed of the tasks assigned to him/her and the possible hazards caused by improper behavior and, if necessary, has been instructed. He/she was also informed of the necessary safety devices and protective measures.

Personnel to be trained, instructed or undergoing general training are only allowed to work under the constant supervision of an experienced person. The personnel read and understood the operating instructions.



- Specialist** A specialist is a person who successfully completed vocational training. The specialist must also have knowledge of the applicable relevant standards and regulations. He/she must be able to assess assigned work and, based on his/her professional training and work experience, recognize and avoid potential hazards on his/her own.
- Skilled electrician** The skilled electrician is a person in the sense of a specialist with special knowledge in the field of electrical engineering (training in a recognized training occupation as a skilled worker, master craftsman, industrial foreman, state-certified technician, graduate engineer, bachelor or master).

2.2.2 Approved personnel

Life phase / chapter	Personnel qualification
Transportation, installation and storage	<ul style="list-style-type: none"> Trained, instructed operating personnel
Startup	<ul style="list-style-type: none"> Trained, instructed operating personnel Specialist Skilled electrician for work on electrical systems or equipment
Operation	<ul style="list-style-type: none"> Trained, instructed operating personnel
Taking out of operation	<ul style="list-style-type: none"> Trained, instructed operating personnel Specialist Skilled electrician for work on electrical systems or equipment
Service and maintenance	<ul style="list-style-type: none"> Trained, instructed operating personnel Specialist Skilled electrician for work on electrical systems or equipment
Disposal	<ul style="list-style-type: none"> Trained, instructed operating personnel Specialist Skilled electrician for work on electrical systems or equipment
Troubleshooting	<ul style="list-style-type: none"> Specialist Skilled electrician for work on electrical systems or equipment

Tab. 3: Approved personnel

Instruction The personnel working on the sensor must regularly be trained and instructed by the operating company.

2.3 Residual risks

2.3.1 Danger from electrical energy

The sensor is connected to the power supply via a 24-volt power supply unit. When connecting the power supply to the sensor, check to ensure that the cable is routed correctly.

Prior to starting maintenance work or disassembly, pull out the mains plug, thus disconnecting the sensor from the power supply.

Ensure that the electrical equipment of the sensor is checked at regular intervals. Defects, such as loose connections, rubbed or scorched cables, must be eliminated immediately by a skilled electrician.

Switch off the sensor immediately in the event of malfunctions in the electrical power supply.

2.3.2 Danger from magnetism

Danger from strong magnets

Powerful magnets are used to secure the sensor on surfaces. These magnets generate electromagnetic fields that can affect cardiac pacemakers and similar devices. This can cause cardiac pacemakers to malfunction. The electromagnetic field affects devices in the immediate vicinity in an area of about 0.5 meters around the sensor. Persons with cardiac pacemakers should not be inside this area.

⚠ WARNING	
	<p>Danger from strong magnets</p> <p>The magnets generate strong electromagnetic fields that can affect and interfere with electronic devices (such as cardiac pacemakers). Malfunctioning cardiac pacemakers can cause death or serious injuries to the persons concerned.</p> <ul style="list-style-type: none"> ➤ Persons with cardiac pacemakers are not allowed to be in the vicinity of the sensor. ➤ Persons with cardiac pacemakers are not allowed to work with or handle the sensor. ➤ Check this warning on the sensor or on the machine tool at regular intervals. Replace damaged warning labels immediately.

The hazard exists even when the sensor is switched off. The magnets are always active. Persons with cardiac pacemakers are therefore not allowed to perform any activities with the sensor (neither transportation, startup, or disposal, nor service and maintenance).

In addition, check the warning labels on the machine tool for damage at regular intervals. These pictograms are the only way to warn uninvolved persons of the magnets and to safeguard them. To do this, comply with the information in the maintenance plan.

Crushing hazard from the magnets

Powerful magnets are used to secure the sensor on surfaces, such as machine housings. During the installation, the magnetic effect can pull the sensor instantaneously towards the surface. This can squeeze the fingers of the fitter if he/she is not careful. This results in a slight bruising of individual fingers or fingertips. To protect from squeezing, the sensor is equipped with recessed grips on the housing. Combined with appropriate care, mounting the sensor is thus possible without risk.

Dropping sensor

Magnets are used to secure the sensor on surfaces. The sensor can drop if there is only little or no magnetic adhesion on the surface. The dropping sensor can bruise the feet of the fitter. The sensor can be damaged when it drops on the floor.

Carefully approach the sensor to the surface to check its magnetic effect. While observing the magnetic effect, hold the sensor by the recessed grips to prevent bruising your fingers. Afterwards, watch the sensor for a short time to see if it moves and risks to drop down. Select a different surface for mounting if the sensor moves.

2.3.3 Danger from leaks and hose lines

Leaks and defective hose lines

Hose lines connect the sensor with a coolant tank. If these lines are damaged or not installed properly, there will be leaks, and coolant will escape.

Leaked coolant can cause injuries (risk of slipping, for example). Consequently, route the hose lines carefully and free of tripping hazards. Prior to starting up the sensor, check the installation of the hose lines at coolant tank and sensor. Observe the specifications in the maintenance plan for regular inspections.





Tripping hazard on lines

Hose lines connect the sensor with the coolant tank. These hose lines must be routed carefully to prevent any risk of tripping. Persons tripping over hose lines can fall and injure themselves. In addition, the lines or the connections on the sensor or the tank can be damaged and coolant can escape in an uncontrolled way.

Hazards from coolants

2.3.4 Hazards from coolants

Depending on the currently used coolant, there can be various hazards and risks. Reading the data sheet of the coolant is therefore absolutely necessary!

⚠ WARNING	
    	<p>Health damage from coolant</p> <p>A direct contact of the coolant with the skin can cause diseases and health damage.</p> <p>Direct contact of your eyes with coolant can cause severe irritation of the eyes.</p> <p>Inhaling the vapors or aerosols can cause irritation and diseases of the respiratory tract.</p> <p>Escaping and/or splashing coolant can contaminate food and drinks.</p> <ul style="list-style-type: none"> ➤ Read the data sheet of the coolant. ➤ Wear protective gloves. ➤ Wear protective goggles. ➤ Be aware during maintenance, servicing, cleaning and disposal that there are residues of the coolant in the hose lines and in the unit even after the unit has been switched off. ➤ Eating and drinking in the vicinity of coolant is prohibited! ➤ Contact a doctor immediately if you experience any discomfort.

Escaped coolant must be wiped up and disposed of immediately. There is a slipping hazard! People can slip on it and injure themselves. Therefore, check the hose lines for leaks at regular intervals (see maintenance schedule).

NOTE	
	<p>Environmental damage from leaking coolant</p> <p>Escaping coolant damages the environment and can be the cause of further hazards.</p> <ul style="list-style-type: none"> ➤ Read the data sheet of the coolant. ➤ Check pipes regularly for leaks. ➤ Repair leaks immediately when they are discovered. ➤ Dispose of coolant in accordance with the regulations. ➤ Be aware during maintenance, servicing, cleaning and disposal that there are residues of the coolant in the hose lines and in the unit even after the unit has been switched off. ➤ Notify the environmental agency responsible in case of a major incident.

2.4 Safety instructions of the sensor

The sensor is delivered with several pictograms and warnings as stickers. Due to the small size of the product, these stickers can not be attached to the sensor. In the course of the assembly, these stickers must instead be glued on in the vicinity of the sensor, for example on the housing of the machine tool. Ensure that these stickers are checked at regular intervals. Damaged stickers must be replaced immediately.



Fig. 4: Safety instructions on the machine tool (example)

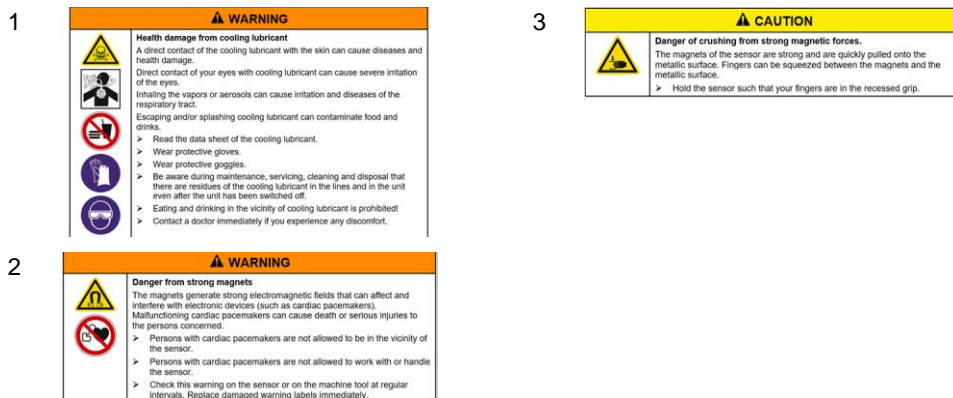

2.5 Emergency information

Behavior in an emergency

In case of an emergency at the sensor, pull out the mains plug to put the sensor out of operation. Check to see if there are any casualties.

SAFETY INSTRUCTION	
	<p>Pull out the mains plug immediately in the event of a malfunction or emergency!</p> <p>This disconnects the sensor from the power supply and shuts it down immediately.</p>



Important information for your safety

You are responsible!

In any case, ensure that the safety instructions in chapter 2 "Basic safety instructions" and the locally applicable safety regulations are observed and complied with.



Important information in the data sheet of the coolant

Different coolants exist that can have different effects on your health. In an emergency, read the data sheet of the coolant!

3 DESCRIPTION, STRUCTURE AND FUNCTION

3.1 Intended use

This sensor may only be used to measure the concentration (via refractive index) and temperature of coolant. The coolant must be emulsifiable in water. The measurement requires the sensor to have access to the coolant tank of a machine tool. Access is established through the inlet and outlet pipes. The app associated with the sensor then collects the acquired data.

The sensor may only be used when:

- It is in a technically faultless state
- The personnel have the necessary safety and hazard awareness
- The instructions in the operating instructions are followed

3.2 Reasonably foreseeable misuse

The sensor is not intended to be used for any other purpose than the one listed here.

Any use other than the intended use is always considered improper use. Safe operation is then no longer guaranteed. The operating company, not the manufacturer, is responsible for any injuries or material damage resulting from improper use.

Foreseeable misuse also includes:

- Improper assembly, startup, operation and maintenance of the sensor
- Operating the sensor in a faulty state
- Operating the sensor without protective coverings
- Installing or operating the sensor in a potentially explosive atmosphere
- Using operating fluids that were not approved by the manufacturer

3.3 Conversions and modifications

For safety reasons, conversions and modifications to the sensor are only permitted after consultation with the manufacturer.

Using non-genuine spare parts may void the liability for any resulting consequences. Consequently, use only the specified spare parts. This applies in particular to safety-relevant components.

3.4 Specifications

Dimensions and weight

	Value	Unit
Length / depth	318	mm
Width	89	mm
Height	125	mm
Weight	2.65	kg

Tab. 4: Dimensions and weight

Connected loads and power – electricity

	Value	Unit
Voltage	24	VDC
Current	max. 2.5	A
Mains connection	External power supply unit with 100-240V / 50-60Hz AC 5 connection adapter (ILC type A, C, G, I)	
Protection rating	IP44	

Tab. 5: Connected loads and power – electricity

Connected loads and power – pump

	Value	Unit
Operating mode	continuous	VDC
Pump interval	Adjustable between 30 and 120 minutes	
Delivery volume	200	ml/cycle
Fluid connection	IQS standard 6/8 mm	

Tab. 6: Connected loads and power – pump

Interfaces

Communication / interfaces
Bluetooth
WiFi
NFC

Tab. 7: Interfaces

Emission values

	Value
Sound power level	<75 dB(A) A-weighted equivalent continuous sound pressure level is below 70 dB(A)

Tab. 8: Emission values

3.5 Location requirements

To ensure trouble-free operation of the sensor, the following location requirements and installation conditions must be satisfied.

Temperature

To guarantee smooth operation, the ambient temperature must be between +5 °C and +40°C. The environment must be frost-free, dry and protected against corrosion.

3.6 Design

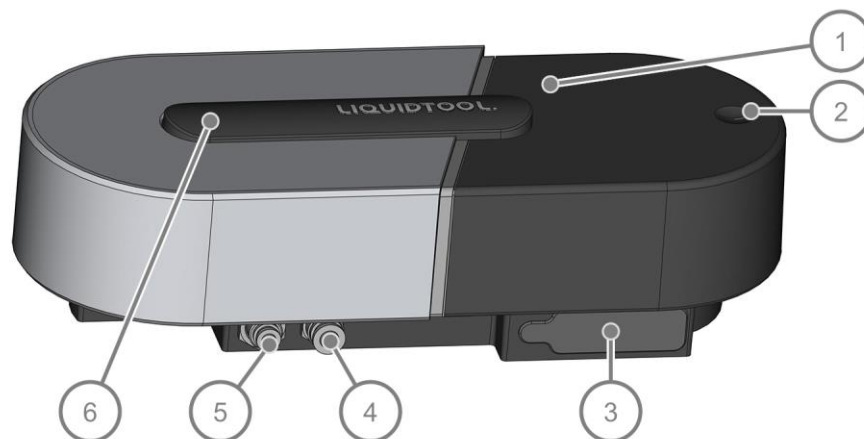

Fig. 5: Design of the sensor (view from diagonally below)

- | | | | |
|---|-----------------------------------------------|---|--------------------------------------------------------------------------------------------|
| 1 | Housing | 4 | Inlet connecting fitting |
| 2 | Capacitive button | 5 | Outlet connecting fitting |
| 3 | Covered connections (4x USB, 1x RJ45 network) | 6 | Removable NFC token to identify the machine tool (NFC-capable, magnetic mounting possible) |

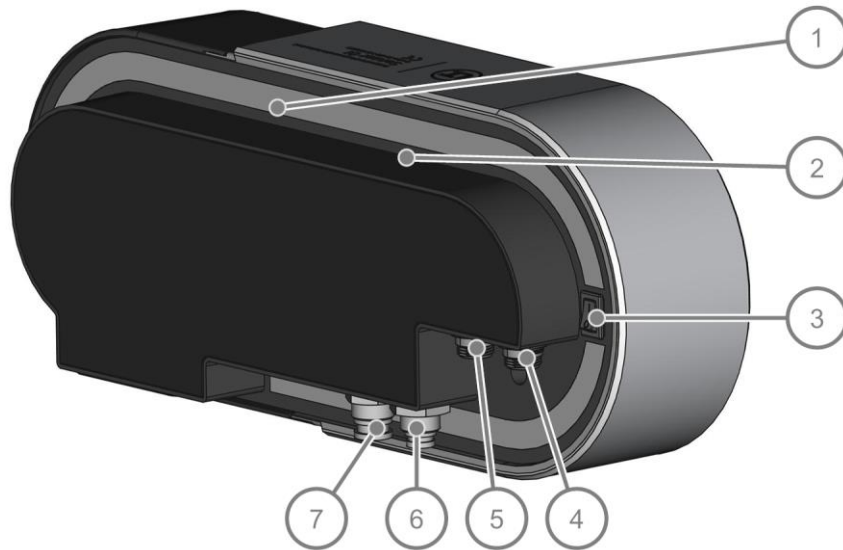

Fig. 6: Design of the sensor (rear view)

- | | | | |
|---|---------------------|---|------------------------------|
| 1 | Background lighting | 5 | Power supply unit connection |
| 2 | Recessed grip | 6 | Inlet connecting fitting |
| 3 | Main switch | 7 | Outlet connecting fitting |
| 4 | RS485 interface | | |

3.7 Functional and system description

The sensor takes samples of the coolant from the coolant tank via the intake hose. Temperature and concentration of the samples are determined before the samples are returned to the tank via the outlet hose. The measuring results are transmitted to the Liquidtool Manager and stored there.

The temperature of the coolant is measured directly in the flow channel.

3.8 LED status indicator

There is an LED in the capacitive button on the front of the product. This LED shines in different colors, indicating the status of the product. You can find more information about this in the Liquidtool app.

Color	State	Description/meaning
White	Shines continuously	The product is switched on
Green	Shines continuously	The product is ready for operation
Blue	Shines continuously	Interaction necessary
Blue	Blinking	The sensor is working (measurement in progress, or software is updated)
Orange	Shines continuously	Information: The measured value is outside the specification
Red	Shines continuously	Fault/malfunction

Tab. 9: Status indicator LED

3.9 Interfaces

The sensor is equipped with the following interfaces:

- WLAN adapter
- Status LED
- Capacitive button
- Mains switch
- Plug connection (power supply unit)
- Plug connection (RS485 interface)
- Covered connections:
 - 4x USB connection
 - 1x RJ45 network
- Inlet with filter
- Outlet

4 TRANSPORTATION, INSTALLATION AND STORAGE

4.1 Introductory safety notes



Personnel qualification

The following personnel are authorized for "transportation, installation and storage":

- Trained, instructed operating personnel



Important information for your safety

You are responsible!

In any case, ensure that the safety instructions in chapter 2 "Basic safety instructions" and the locally applicable safety regulations are observed and complied with.

Wear the necessary personal protective equipment (PPE).

SAFETY INSTRUCTION	
	<p>Important transportation information</p> <p>A used sensor must be taken out of service and cleaned before it is transported. Follow the instructions in the respective chapter.</p> <ul style="list-style-type: none">➤ Information about taking out of service can be found in chapter "7 Taking out of operation" on page 29.➤ Information about cleaning can be found in chapter "7.4 Cleaning" on page 32.
⚠ WARNING	
	<p>Danger from strong magnets</p> <p>The magnets generate strong electromagnetic fields that can affect and interfere with electronic devices (such as cardiac pacemakers). Malfunctioning cardiac pacemakers can cause death or serious injuries to the persons concerned.</p> <ul style="list-style-type: none">➤ Persons with cardiac pacemakers are not allowed to be in the vicinity of the sensor.➤ Persons with cardiac pacemakers are not allowed to work with or handle the sensor.➤ Check this warning on the sensor or on the machine tool at regular intervals. Replace damaged warning labels immediately.

4.2 Packaging

The sensor is packed in cardboard boxes. Unpack all parts and dispose of the packaging in an environmentally compatible way.

4.3 Transportation

Due to its low weight, you can carry the sensor in its packaging to your installation site.

4.4 Delivery

4.4.1 Scope of delivery

The scope of delivery contains:

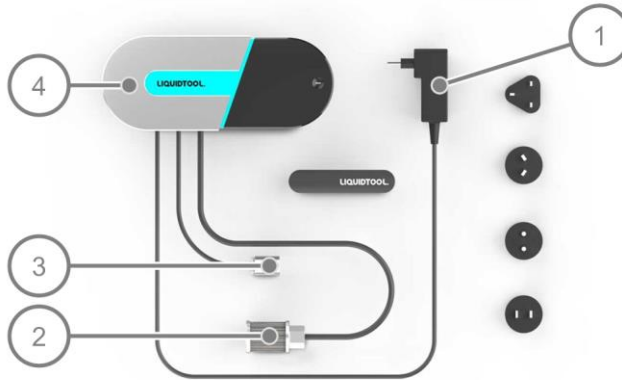

Fig. 7: Scope of delivery

- 1 Connecting cable with power supply unit
- 2 Outlet hose (including weight)
- 3 Intake hose (including filter)
- 4 Sensor 01
- 5 Safety information and warnings

4.4.2 Checking for transportation damage

Check the sensor for transportation damage immediately after it has been delivered to the installation location. Report any transportation damage immediately to the manufacturer. Documenting transportation damage with photos is recommended

4.5 Downloading the app

The sensor is controlled and used via a specifically developed app (Coolant Manager). The app can be downloaded and installed via a smartphone.



Use the following procedure to download the app:

1. Scan the QR code below with an appropriate app/camera of your smartphone.

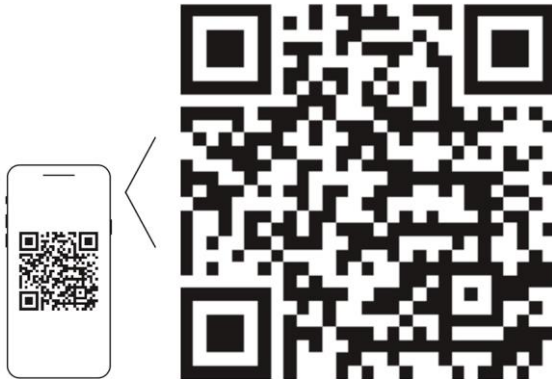

LIQUIDTOOL App

<https://download.liquidtool.com/apps>

Fig. 8: QR code to download the app

- Your smartphone asks you whether you want to open the link.
2. Open the link.
 - This opens the website of the sensor manufacturer.
3. Follow the instructions on the display.
 - ✓ The download of the app is completed. The app can be used.

4.6 Storage

The following criteria must be satisfied when storing the sensor:

- Store at a dry and cool place
- Max. 95% relative humidity
- Clean the sensor before storage

5 STARTUP

5.1 Introductory safety notes



Personnel qualification

The following personnel are approved for "Startup":

- Trained, instructed operating personnel
- Specialists for special work on machine tool, cooling lubricant tank or electrical system



Important information for your safety

You are responsible!

In any case, ensure that the safety instructions in chapter 2 "Basic safety instructions" and the locally applicable safety regulations are observed and complied with.

Wear the necessary personal protective equipment (PPE).

5.2 Installation

Installation plan

The sensor must be installed as shown in the installation plan. A typical installation is shown below schematically.

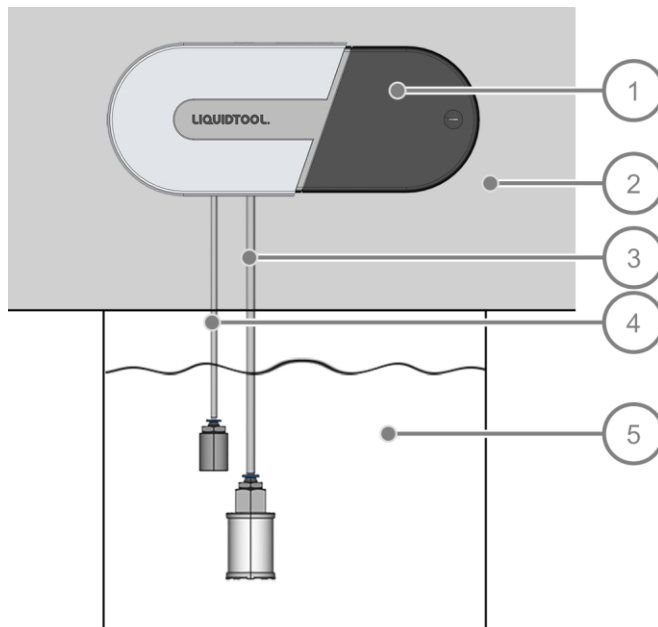

Fig. 9: Installation plan

- 1 Sensor 01
- 2 Machine tool on which sensor 01 is installed
- 3 Intake hose
- 4 Outlet hose
- 5 Coolant tank

Installation location

The following requirements must be satisfied for the installation site of the sensor:

- In the vicinity of the coolant tank
- No installation in potentially explosive areas
- Ideally installed in a vertical/horizontal arrangement (sensor not lying down, i.e. no installation with the magnets horizontal to the ground)
- Work area around the sensor should be 1 meter
- Route the connections (cables and hose lines) between the components without tripping hazards

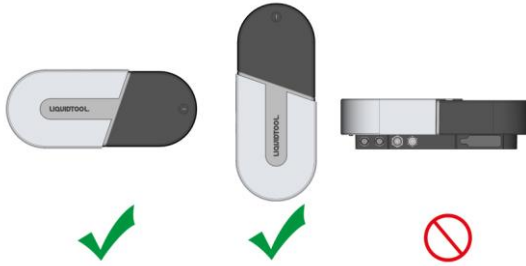

5.3 Identification of the machine tool

To enable you to easily and securely identify the monitored machine tool, the sensor is equipped with a removable, magnetic NFC token with integrated NFC (RFID). You can attach it to any metallic magnetic surface. Mark the machine tool you want to monitor before connection and startup.



Use the following procedure to mount the magnetic NFC token on the machine tool:

1. Detach the NFC token from the sensor.

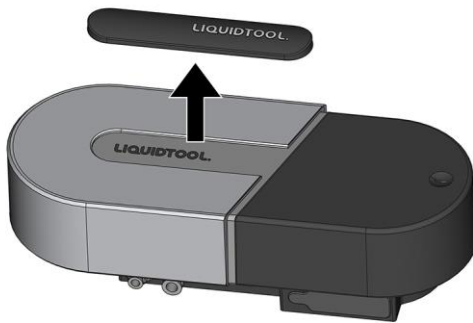

Fig. 10: Detaching the NFC token from the sensor

2. Attach the NFC token on the machine tool you want to monitor. Attaching the NFC token near the machine control is recommended.
 - ✓ The machine tool is identified.

5.4 Information for the connection of the sensor

The sensor must be installed and started up near the coolant tank of the machine tool. Magnets at the rear of the product are used to mount the sensor. This requires a magnetic surface. Direct installation above the coolant tank is not mandatory, the hose lines are rather long. Ensure that the instructions in the following chapters are observed.

5.5 Connection

Requirement:

- The machine tool was marked
- The information about the connection was read and understood
- 1 copy of each warning and safety instruction is available



Use the following procedure to connect the sensor:

1. Remove the plugs (2) from the hose lines. To do this, press the metal coupling rings (1) in the direction of the sensor while you are pulling out the plugs (2).

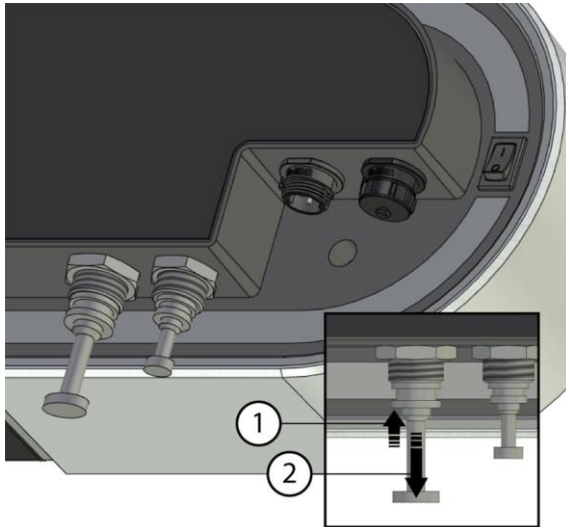

Fig. 11: Removing the plugs

2. Connect the power cable provided to the sensor. The connection is at the bottom.
 - Connect the cable to the left connection. The right connector is an RS 485 port.



Fig. 12: Connecting the power cable

3. Connect the hose lines provided to the sensor. To do this, press the metal coupling rings (1) in the direction of the sensor while you are inserting the hose lines (2) into the bushings. Release the coupling ring.
 - The coupling ring moves back to its initial position, thus locking the hose line.
 - The left connection is for the hose line with pump. The right connection is for the outlet hose

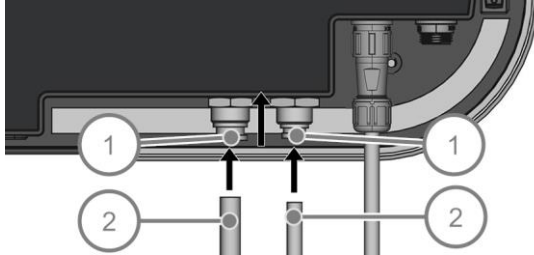

Fig. 13: Connecting the connecting lines



Fig. 14: hose lines connected

4. **⚠ CAUTION!** Danger of crushing from strong magnetic forces. The magnets of the sensor are strong and are quickly pulled onto the metallic surface. Fingers can be squeezed between the magnets and the metallic surface. Hold the sensor such that your fingers are in the recessed grip.
5. Guide the rear of the sensor to a magnetic surface near the coolant tank. Attaching the sensor above the coolant tank is recommended.

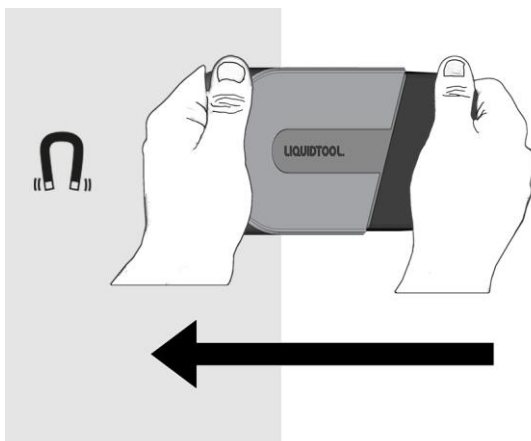

Fig. 15: Attaching the sensor on the surface

- You will notice whether or not the magnets are holding the sensor.
6. The surface is not suitable for attachment if the magnets do not hold the sensor. Find another surface and repeat the previous step.
- **⚠ CAUTION!** Risk of injury from dropping sensor! Release the sensor only slowly. This allows you to see whether or not it is slipping or moving. Hold on to the sensor if it slips or moves. You can thus prevent minor injuries to your feet and damage to the sensor.
 - The magnets of the sensor are strong and hold it in position.
7. Attach the warning and safety notices provided around the sensor.



Fig. 16: Attaching warnings (example)

8. Insert the two connecting lines into the coolant tank.

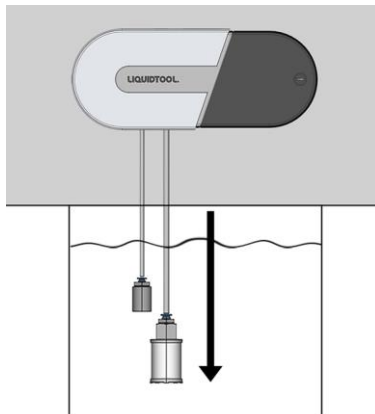

Fig. 17: Hose lines in the coolant tank

9. Check the lengths of the hose lines. The distance between the sensor and the surface of the coolant must not be greater than 1.5 meters. Also, take a lower liquid level in the tank into account here!

10. Check the filter of the intake hose. It must not be in contact with the bottom of the tank. To obtain optimum results, the suction filter should be completely surrounded by coolant.

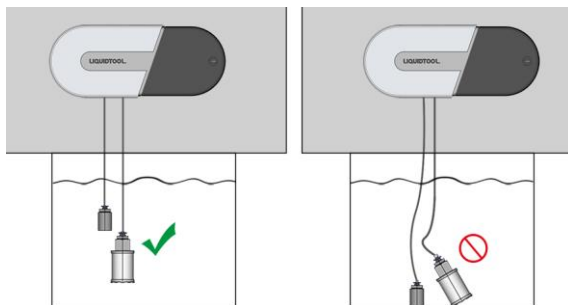

Fig. 18: Correctly routed hose lines

11. Insert the mains plug into a suitable socket outlet.
✓ The connection of the sensor is completed. Download the app now.

6 OPERATION

6.1 Introductory safety notes



Personnel qualification

The following personnel are approved for "operation":

- Trained, instructed operating personnel for using the sensor within the scope of the intended use



Important information for your safety

You are responsible!

In any case, ensure that the safety instructions in chapter 2 "Basic safety instructions" and the locally applicable safety regulations are observed and complied with.

Wear the necessary personal protective equipment (PPE).

6.2 Switching on the sensor

Requirement:

- The sensor is connected



Use the following procedure to switch on the sensor:

1. Ensure that the sensor is connected as described in chapter "5.5 Connection" on page 24 .
2. Press the power switch on the back of the sensor to position "I".
 - The status indicator on the front lights up.
 - The background lighting is switched on.
 - ✓ The sensor is switched on.

6.3 Switching off the sensor

Requirement:

- The sensor is switched on



Use the following procedure to switch off the sensor:

1. Press the power switch on the back of the sensor to position "O".
 - The background lighting goes out.
 - The status indicator on the front shines blue and goes out after a few seconds.
 - ✓ The sensor is switched off.

6.4 Operation

The sensor is operated via the associated app (Liquidtool Manager). Use the procedure described in the chapter "4.5 Downloading the app" on page 21 to download the app.

Further information about operation can be found in the app.

7 TAKING OUT OF OPERATION

7.1 Introductory safety notes



Personnel qualification

The following personnel are approved for "taking out of operation":

- Trained, instructed operating personnel for activities on the sensor.
- Specialists for special work on machine tool, coolant tank or electrical system.
- Only instructed and authorized skilled electricians are allowed to carry out electrical work



Important information for your safety

You are responsible!

In any case, ensure that the safety instructions in chapter 2 "Basic safety instructions" and the locally applicable safety regulations are observed and complied with.

Wear the necessary personal protective equipment (PPE).

 CAUTION	
	<p>Slipping hazard from escaped coolant</p> <p>After the sensor has been switched off, there are still residues of the coolant in the hose lines and in the sensor itself. These can flow out when the unit is taken out of service, and can accumulate on the floor in puddles. There is a risk of persons stepping into the puddle, slipping and injuring themselves.</p> <ul style="list-style-type: none">➤ Consult the data sheet of the manufacturer if coolant is leaking out.➤ Eliminate puddles and leaked coolant immediately.➤ Inform other people about the danger.

7.2 Remove the identification of the machine tool

When you take the sensor out of operation, you should also remove the identification on the machine tool. You can thus prevent misunderstandings. The NFC token is then stored on the sensor until the next use.



Use the following procedure to remove the NFC token from the machine tool:

1. Go to the machine tool with the NFC token.
 - The NFC token is attached magnetically to the housing of the machine tool.
2. Pull the NFC token off the machine tool.
3. Stow the NFC token on the sensor.

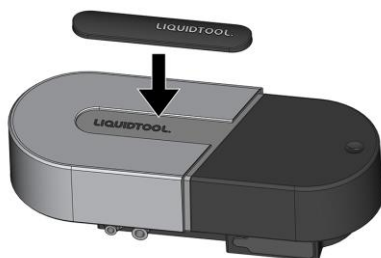

Fig. 19: Attaching the NFC token of the sensor

- The magnets hold the NFC token in position.
- ✓ The NFC token is removed from the machine tool and stored.

7.3 Removal

Requirement:

- The identification was removed from the machine tool
- The information about taking the unit out of operation was read and understood
- The sensor is switched off
- Wear the necessary personal protective equipment (PPE)
- Take the information on the data sheet of the coolant into account
- Absorbent paper



Use the following procedure to remove the sensor:

1. Pull the mains plug out of the socket outlet.
2. Put down the plug at a place where you can see it. This prevents reconnection by somebody else.
3. **⚠ WARNING!** Risk of a short-circuit! Ensure that the plug of the power cable is not connected to a socket outlet. There is the risk of a short circuit if the electrically connected sensor drops into the coolant tank.
4. **⚠ WARNING!** Risk of injury from contact with coolant. Although the sensor is switched off, there can still be residues of the coolants on or in hose lines or in the product. A direct contact of the coolant with the skin can cause diseases and health damage. Inhaling the vapors or aerosols can cause irritation and diseases of the respiratory tract. Wear the required protective equipment and observe the instructions on the data sheet for the coolant.
5. Remove the supply hose line including the filter from the coolant tank. Use the absorbent paper to collect escaping coolant.

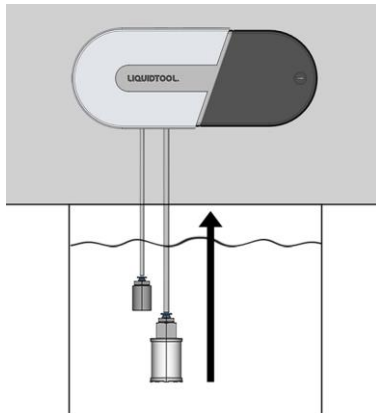

Fig. 20: Removing the hose line

6. Press the Status button briefly.

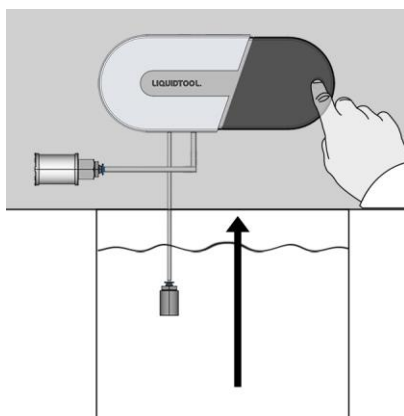

Fig. 21: Starting the manual measurement

- A manual measurement is started.
 - The sensor is emptied. After a few seconds, the pump should run dry and sound different. This shows that there is no more coolant in the sensor.
7. Now, remove the outlet hose from the coolant tank.
 8. Pull the sensor off the surface. It is attached with magnets only. It can be pulled off with some force.

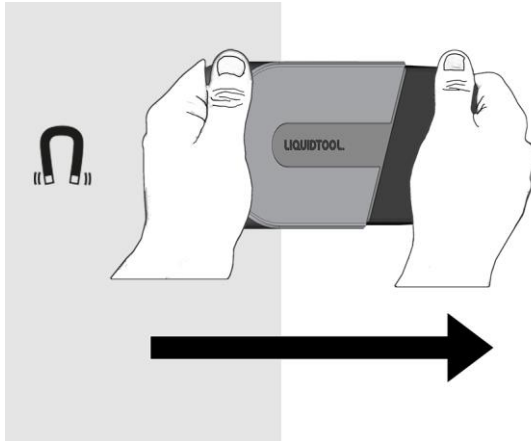

Fig. 22: Removing the sensor from the surface



Fig. 23: Sensor with hose lines

9. **⚠ CAUTION!** Risk of injuries from leaking coolant. It is possible that there are still residues of the coolant in the hose lines. These residues can escape and pose a slip hazard. Eliminate escaped coolant immediately. Clean immediately. Wear the required protective equipment and observe the instructions on the data sheet for the coolant.
 - ✓ The sensor is removed and can be cleaned.



Important removal information

Due to the cooling lubricant residues on the product, we recommend cleaning the product promptly. This helps you to prevent the contamination of surfaces or other products with cooling lubricant. Dispose of the cooling lubricant in accordance with the instructions of the manufacturer.

7.4 Cleaning

Requirement:

- The sensor is switched off
- A mobile terminal with installed app (mobile)
- Wear the necessary personal protective equipment (PPE)
- Take the information on the data sheet of the coolant into account

Cleaning of the sensor outside:

- Clean the surfaces of the sensor with a cloth slightly moistened with soapy water
- No moisture must get into the sensor when cleaning it. Never immerse the sensor in a cleaning liquid or water or spray any liquid on it

Sensor cleaning process:

- The instructions can be found in the Liquidtool App in Messaging & Help System

8 SERVICE AND MAINTENANCE

Activity/area	Description	Interval
Checking the hose lines	for trip-free routing for leaks	Weekly Weekly
Safety and warnings on the product / machine tool	check for completeness replace if damaged	Monthly Monthly

Tab. 10: Maintenance plan

Sensor is maintenance-free

The product was designed to be maintenance-free. Maintenance work on the sensor is not necessary.



Important information about the measuring results

You are welcome to send us the sensor. We will then check the sensors and the measurement results, and repair the product if necessary.

This gives you a long-lasting product and error-free and accurate measurement results.

8.1 Troubleshooting

There is a malfunction if the sensor does not function properly. Use the Messaging & Help System in the Liquidtool App to solve the problem.

9 DISPOSAL

9.1 Introductory safety notes



Personnel qualification

The following personnel are approved for "disposal":

- Trained, instructed operating personnel
- Only instructed and authorized skilled electricians are allowed to carry out electrical work



Important information for your safety

You are responsible!

In any case, ensure that the safety instructions in chapter 2 "Basic safety instructions" and the locally applicable safety regulations are observed and complied with.

Wear the necessary personal protective equipment (PPE).

9.2 Removal



Important removal information

Only instructed and authorized personnel are allowed to remove the sensor.

9.3 Proper and environmentally compatible disposal



Important information

The objective is a proper and environmentally compatible disposal. Waste material that must be disposed of can occur during certain maintenance work or when the sensor is removed. Appropriate recommendations are issued by the corresponding bodies.

The recommendations for the disposal of waste material are derived from the regulations in force at the place and time of preparation of this manual. As the operating company and user of the sensor, you have the obligation to inform yourself about the waste disposal regulations applicable to your region, and to act in accordance with them.

9.4 Disposal points

Please refer to your region for the appropriate disposal points.