

OEM GNSS Antenna HX-CSX192A

Harxon HX-CSX192A is a precision tuned, stacked patch GNSS antenna that provides reliable and consistent positioning services across full bandwidth of the antenna. And it supports BT/WiFi signal received. Its superior positioning accuracy and powerful system compatibility makes it ideal to be integrated into various surveying and RTK applications.

HIGHLY INTEGRATED LAYOUT FOR EASY INTEGRATION

HX-CSX192A integrates GNSS antenna WIFI, and BT into one compact enclosure. Adopting multiple antennas in one solution greatly simplify the complexity of different types antennas integration for applications. Harxon employs self-developed microwave material for isolating interrelated effect among these antennas for reliable signal receptions.

STABLE PHASE CENTER FOR REMARKABLE PERFORMANCE

HX-CSX192A supports multi-constellation full frequency satellite signal tracking, including GPS, GLONASS, Galileo, BeiDou, QZSS, IRNSS and L-band correction service. It features multi-point feeding capability and guarantees a reliable phase center for millimeter positioning accuracy.

TRACKING IN COMPLEX ENVIRONMENTS

This antenna exhibits superior high gain performance with ultralow signal loss, ensuring reliable satellite signal tracking. It also delivers wide beam width that covers wide frequencies with high marginal gain. These features ensure the antenna robust signal availability even in low elevation, making the antenna a perfect option for complex environments with blockage, such as tree canopy and buildings.

EASY INTEGRATION DESIGN FOR PRECISION APPLICATIONS

The unique structure design simplifies the RTK integration, and minimizes the overall machine dimension, aiming to bring system integrators high efficiency performance of navigation and communication in surveying and precision agriculture applications.

GREAT ANTI-INTERFERENCE CAPABILITY

The HX-CSX192A antenna equips an anti-multipath interceptor and provides superior multi-path signal rejection. Besides, the pre-filtered LNA of the antenna restrains unwanted electromagnetic interferences and significantly avoids signal loss in challenging environments like power grid, communication base station and broadcasting stations.

KEY FEATURES

- Comprehensive GNSS support: GPS, GLONASS, Galileo, BeiDou and L-Band correction services
- Support BT/WiFi signal received
- Stable phase center guarantees the accuracy of positioning within millimeter-level
- Improved signal filtering and excellent multipath rejection
- Powerful system compatibility, easy for integration

OEM GNSS Antenna HX-CSX192A

PERFORMANCE

Signal Received

GPS	L1/L2/L5
GLONASS	L1/L2/L3
GALILEO	E1/E5a/E5b/E6
BDS	B1I/B2I/B3I/B1C/B2a/B2b
QZSS	L1/L2/L5/L6
IRNSS	L5
L-Band	
BT/WiFi	

Nominal Impedance 50Ω

Polarization RHCP

Axial Ratio ≤3dB

Azimuth Coverage 360°

Output VSWR ≤2.0

Peak Gain GNSS:5dBi
WiFi:2dBi

Phase Center Error ±2mm

LNA

LNA Gain

L1: 38±2dB

L2: 40±2dB

Noise Figure ≤2dB

Output VSWR ≤2.0

Passband Ripple ±2dB

Operation Voltage +3.3 ~ +12VDC

Operation Current ≤45mA

Differential Propagation Delay ≤5ns

MECHANICAL

Dimensions

φ122.4*22.3mm (Connectors not included)

Weight ≤170g

Connector

GNSS: 1*SMP-JE-5

BT/WiFi: 1*SMP-JE-5

Mounting 4 x M3 screws mount

ENVIRONMENTAL

Temperature

Operating -40°C to +85°C

Storage -55°C to +85°C

Humidity 95% No-condensing

en.harxon.com

sales@harxon.com

9/F, Block B, Building D3, TCL International

E City, NO.1001 Zhongshanyuan Road,

Nanshan District, Shenzhen, China

Tel: +86-755-26989948

Fax: +86-755-26989994

Version 1 Specifications subject to change without notice.

©2022 Harxon Corporation. All rights reserved.

Printed in China

September 2022

OEM GNSS Antenna HX-CSX192A

Table 1: Test Data of Passive Antenna Performance

Frequency (MHz)	Peak Gain (dBi)	Axial Ratio (dB)	Front-to-Rear Ratio (dB)	Frequency (MHz)	Peak Gain (dBi)	Axial Ratio (dB)	Front-to-Rear Ratio (dB)
1176.0	5.6	1.1	26.6	1230.0	6.6	0.8	27.9
1179.0	5.9	1.0	27.9	1233.0	6.6	0.9	26.5
1182.0	6.0	0.9	27.8	1236.0	6.6	0.9	26.4
1185.0	6.0	0.8	27.9	1239.0	6.5	0.9	25.6
1188.0	6.2	0.8	28.4	1242.0	6.4	1.0	24.3
1191.0	6.3	0.7	28.5	1245.0	6.3	1.1	24.1
1194.0	6.4	0.7	28.6	1248.0	6.3	1.1	23.7
1197.0	6.4	0.7	29.0	1251.0	6.2	1.2	23.5
1200.0	6.5	0.7	29.3	1254.0	6.0	1.3	24.7
1203.0	6.6	0.7	29.5	1257.0	6.0	1.3	24.8
1206.0	6.7	0.6	30.1	1260.0	5.9	1.4	25.1
1209.0	6.7	0.6	30.5	1263.0	5.8	1.5	25.2
1212.0	6.7	0.6	29.6	1266.0	5.6	1.5	25.7
1215.0	6.7	0.6	29.6	1269.0	5.5	1.5	25.9
1218.0	6.7	0.7	29.0	1272.0	5.4	1.5	28.2
1221.0	6.7	0.7	28.5	1275.0	5.3	1.6	28.9
1224.0	6.8	0.7	28.4	1278.0	5.1	1.6	29.5
1227.0	6.7	0.8	27.7				

Frequency (MHz)	Peak Gain (dBi)	Axial Ratio (dB)	Front-to-Rear Ratio (dB)	Frequency (MHz)	Peak Gain (dBi)	Axial Ratio (dB)	Front-to-Rear Ratio (dB)
1559.0	4.9	0.4	26.5	1586.0	5.6	0.2	28.5
1562.0	5.1	0.4	26.8	1589.0	5.5	0.2	28.4
1565.0	5.2	0.4	27.2	1592.0	5.5	0.2	26.9
1568.0	5.3	0.4	27.6	1595.0	5.6	0.3	26.6
1571.0	5.4	0.3	27.9	1598.0	5.5	0.3	26.5
1574.0	5.5	0.3	28.3	1601.0	5.3	0.4	25.2
1577.0	5.4	0.3	28.8	1604.0	5.1	0.4	24.7
1580.0	5.4	0.3	29.1	1607.0	5.2	0.5	24.8
1583.0	5.6	0.2	29.3	1610.0	5.0	0.5	23.9

OEM GNSS Antenna HX-CSX192A

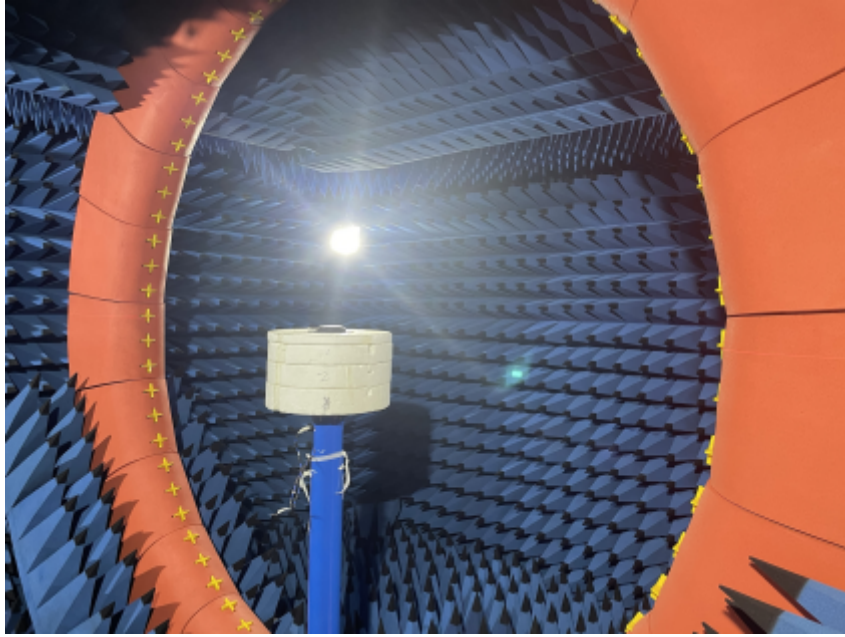

Test Site Picture

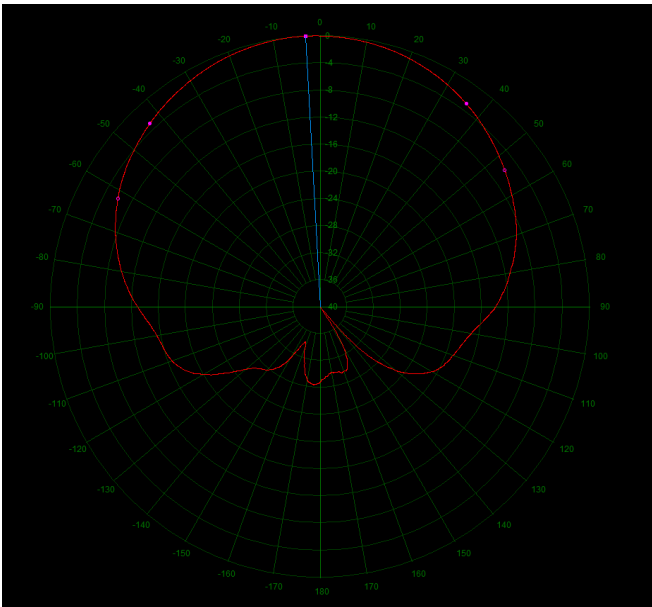

1176MHz Pattern Graph

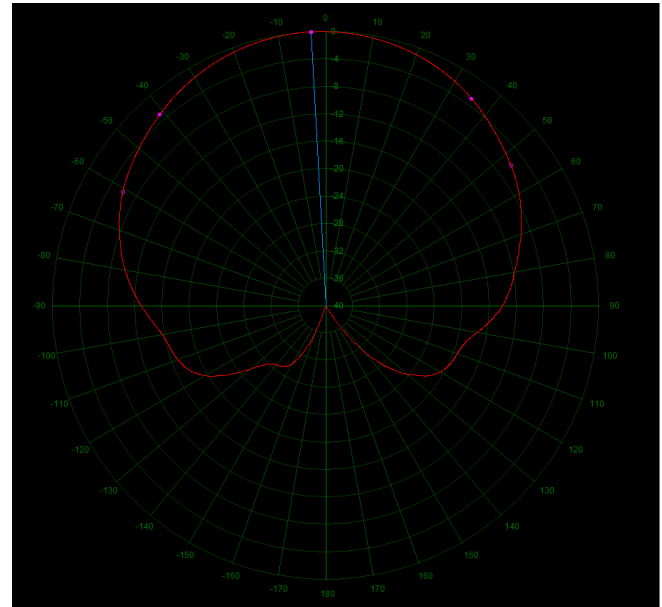

1206MHz Pattern Graph

OEM GNSS Antenna HX-CSX192A

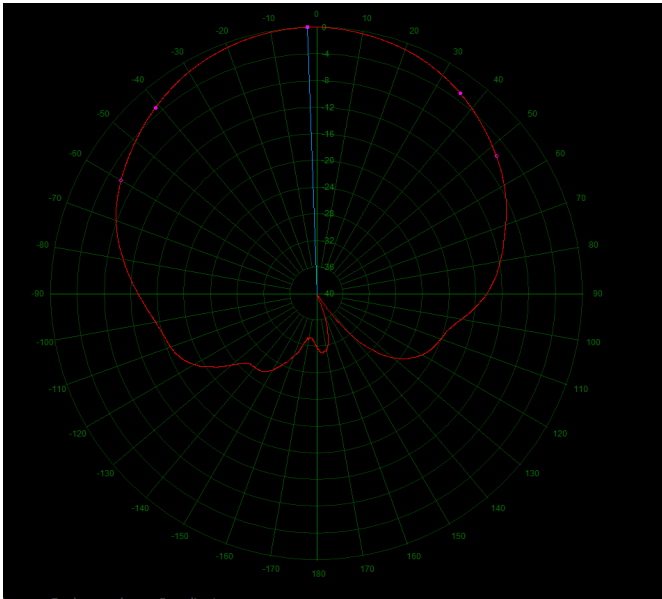

1227MHz Pattern Graph

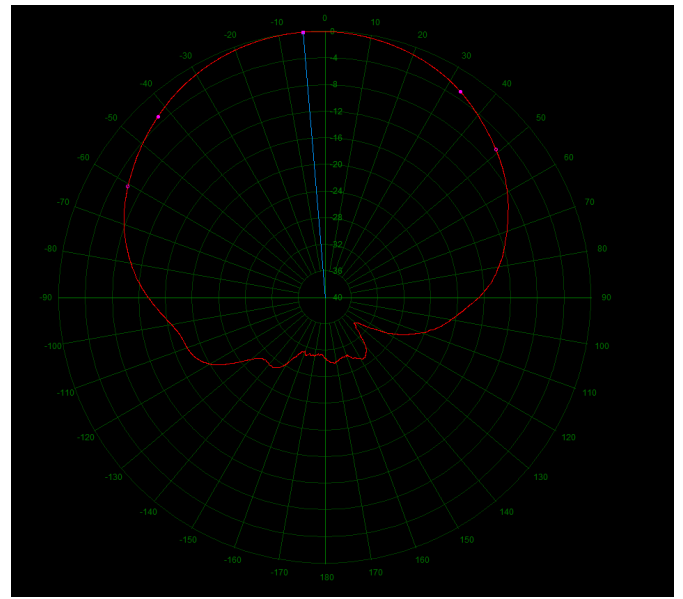

1269MHz Pattern Graph

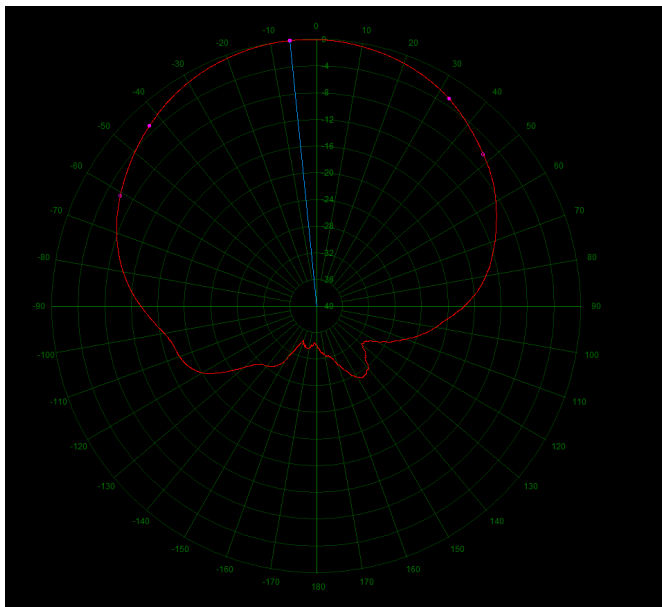

1278MHz Pattern Graph

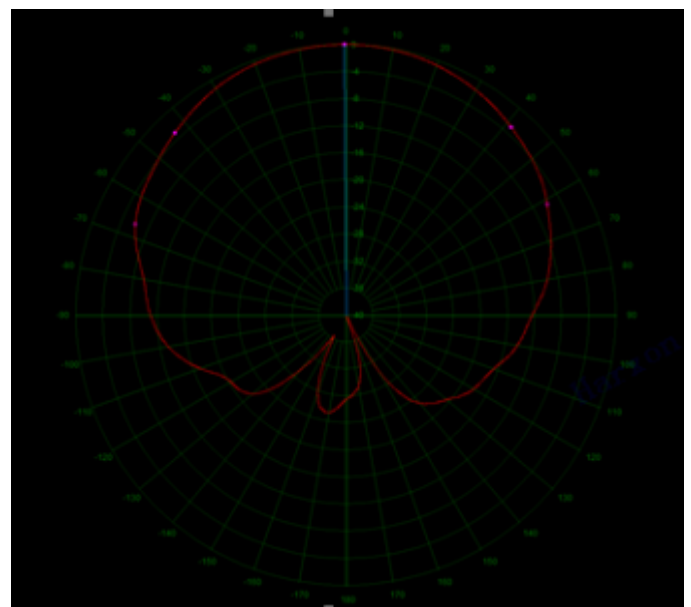

1562MHz Pattern Graph

OEM GNSS Antenna HX-CSX192A

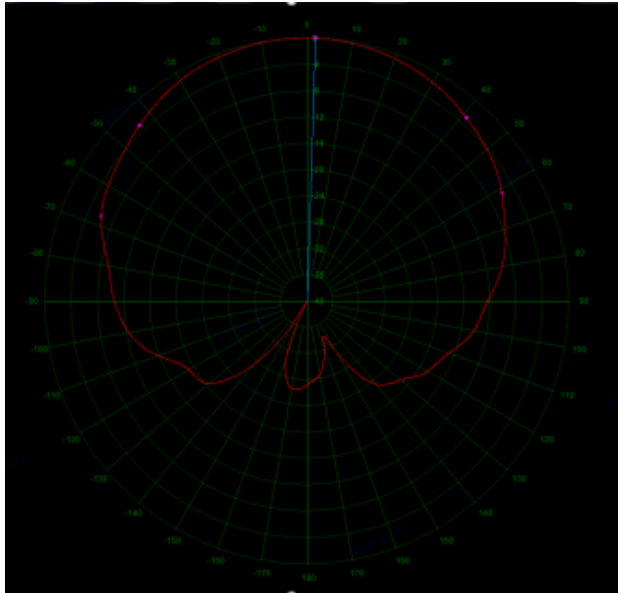

1269MHz Pattern Graph

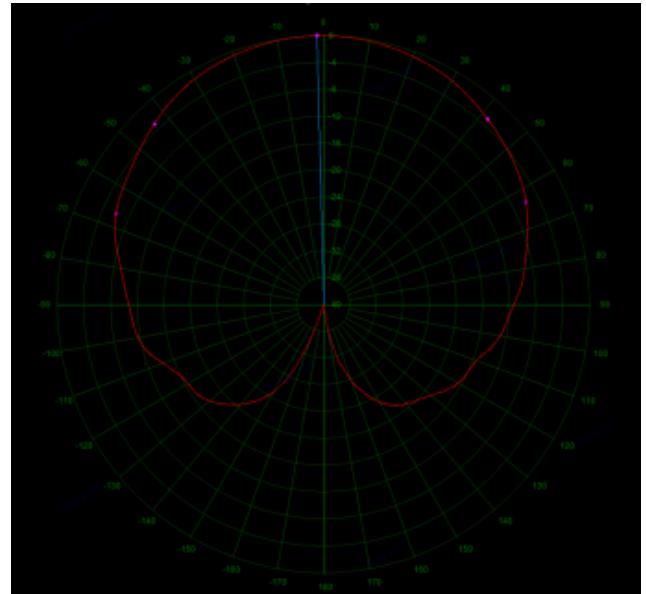

1610MHz Pattern Graph

Table 2: Test Data of BT/ WiFi Antenna

Frequency (MHz)	2400	2405	2410	2415	2420	2425	2430	2435	2440
Frequency (%)	56.6	59.0	60.5	60.4	60.0	60.4	59.9	59.7	59.9
Frequency (MHz)	2445	2450	2455	2460	2465	2470	2475	2480	2485
Frequency (%)	59.6	58.7	58.4	58.7	59.0	57.9	57.9	57.2	57.4
Frequency (MHz)	2495	2500							
Frequency (%)	56.6	55.3							

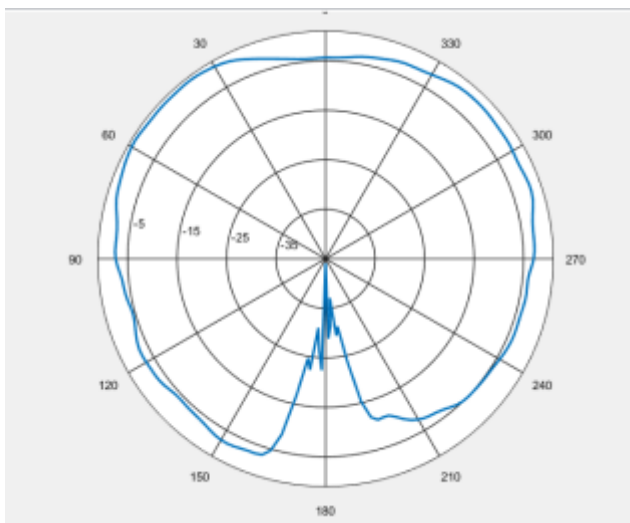

2450MHz Pattern Graph

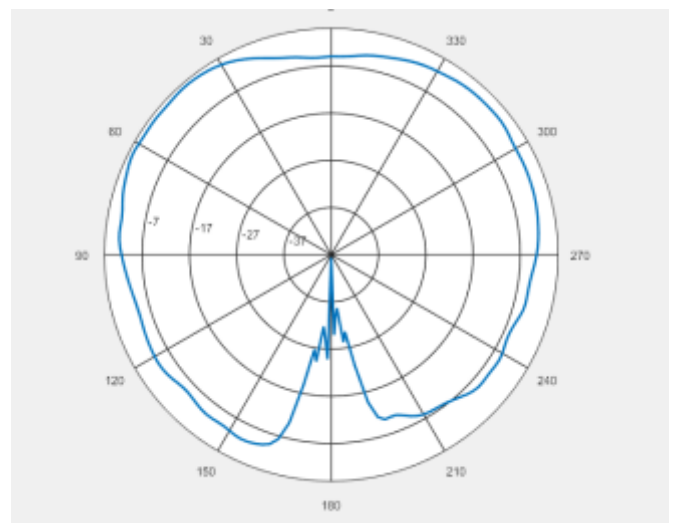

2480MHz Pattern Graph

OEM GNSS Antenna HX-CSX192A

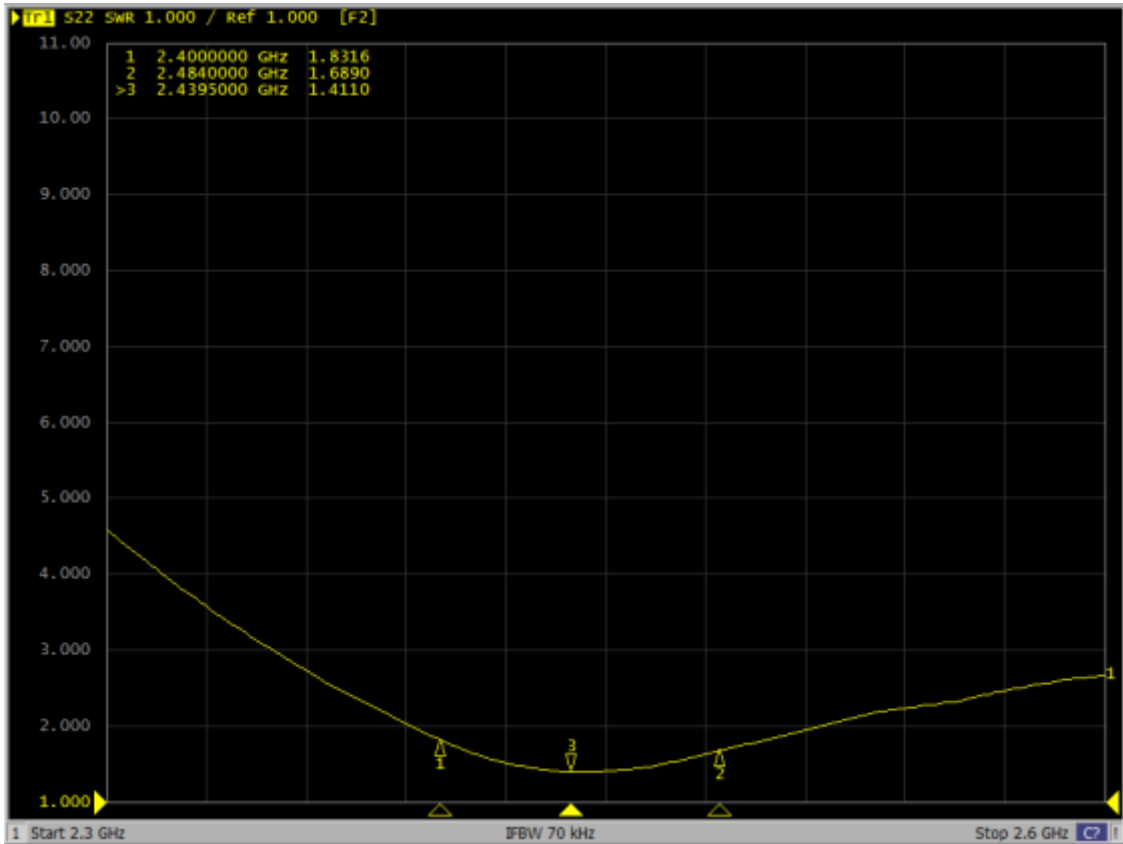

BT/WIFI VSWR

Structure & Phase Center Drawing (mm)

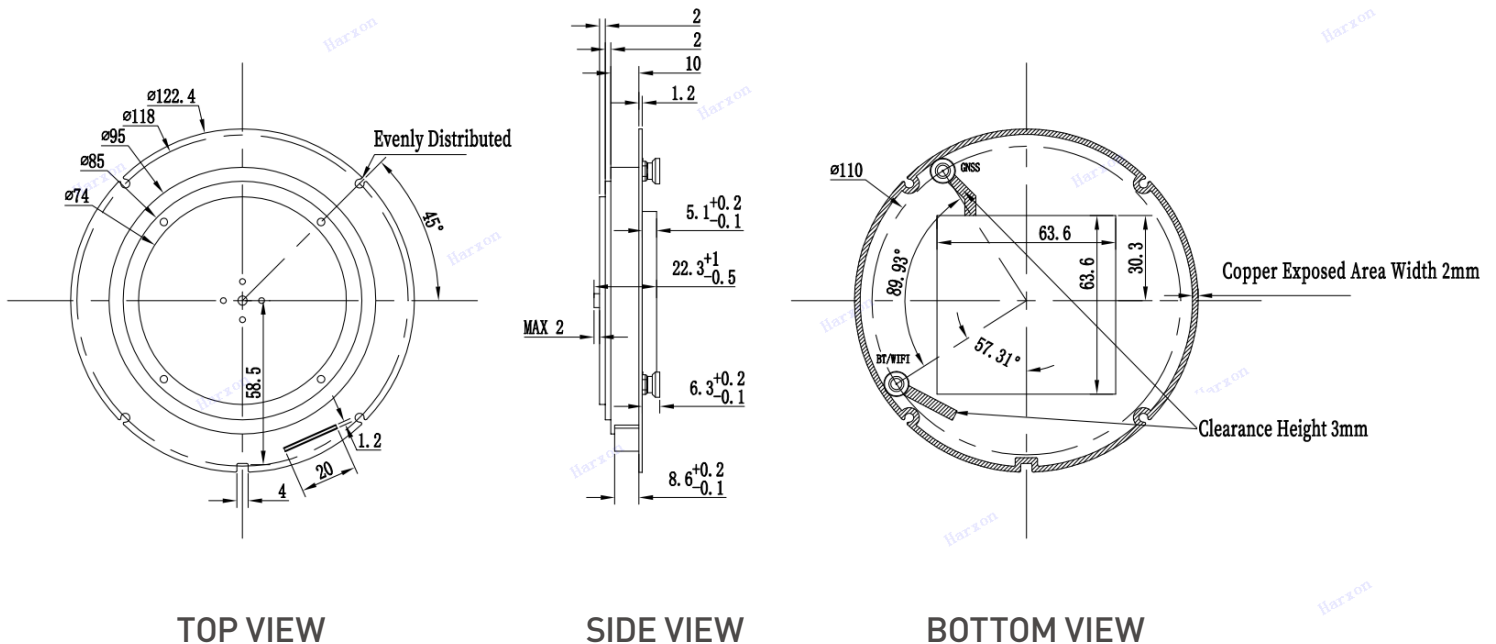

Undeclared Tolerance: $\pm 0.3\text{mm}$