

AQUAJET USER MANUAL

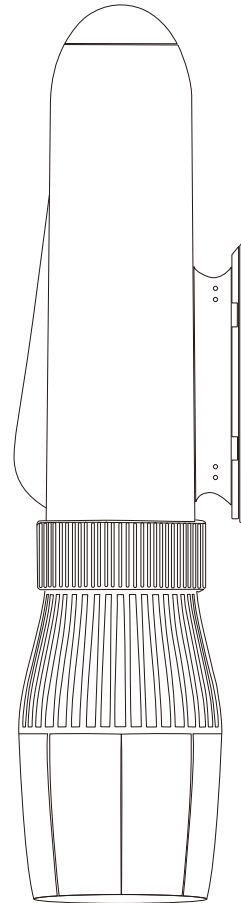

Huizhou Chuanliubuxi Electronic Plastic Co., Ltd

Contents

I	Warning and Attention	1
II	Parts of AQUAJET	2
III	Technical Specifications	2
IV	AQUAJET In Use	3-4
V	Remote Control	5
VI	After Using AQUAJET	6
VII	Model parameters.....	6-9

I. Warning and Attention



Ignoring the instructions in this manual or mishandling the AQUAJET could cause malfunction, operational problems to the device damage, or personal Injury. accepts no liability for any damage caused by actions that contradict this operating manual.

WARNING: For the purposes of recharging the battery, only use the detachable supply unit provided with this appliance.

1. Please fully charge the appliance before use. (The charge port is at the top of the propeller. The motor cover need to be twisted off when charging.)
2. Charging voltage is 25.2V. Do not overvoltage charge. Charging the remote control with the USB charge cable.
3. Please use the charger provided by the original factory.
4. Make sure the motor cover is tightly closed before use, as water can damage the machine.
5. Keep objects such as hand, hair and clothing away from the propeller. If something gets stuck in the propeller, please make sure the propeller is closed before attempting to move the jammed thing.
6. Do not disassemble the machine without permission to avoid damage.
7. Do not put the appliance into the fire.
8. Do not place the appliance in the environment with high temperature above 60°C. Do not use the appliance in the water with Max. temperature above 35°C.
9. This appliance can be used by children aged from 16 years and above and persons with reduced physical, sensory or mental capabilities or lack of experience and knowledge if they have been given supervision or instruction concerning use of the appliance in a safe way and understand the hazards involved. Children shall not play with the appliance. Cleaning and user maintenance shall not be made by children without supervision.
10. The appliance is only to be used with the power supply unit provided with the appliance.
11. This appliance contains batteries that are non-replaceable.
12. The light on the charger will be green when the battery is full.
13. If it has not been used for a long time, please charge it for one hour and save it.
14. Do not use the appliance while tired or under the influence of alcohol, drugs or medication. A moment of inattention may result in serious personal injury.
15. Using the appliance during pregnancy is not allowed.
16. Rinse with fresh water after each use, especially after use in salt water.
17. Always charge the battery on a non-flammable base.

II. Parts of AQUAJET

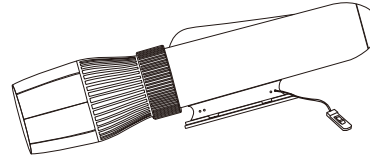

Propeller x 1

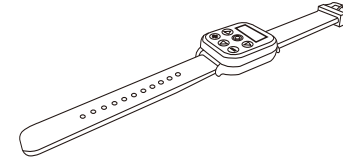

Remote Control x 1

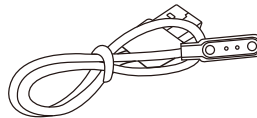

USB Charge Cable x 1

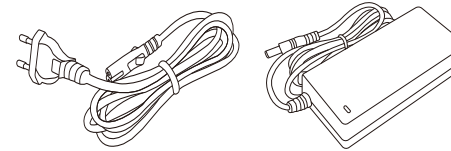

Propeller Charge Unit x 1

III . Technical Specifications

Propeller motor	DC24V
Propeller battery	Rechargeable lithium ion battery 22.2v
Propeller Charger	Input : 100-240V 50 / 60Hz , 15A Max Output : 25.2V DC 2A
Remote control battery	250 mAh
Remote control charging	USB 5V
Remote control frequency	868MHz

IV. AQUAJET In Use

1. Preparing the AQUAJET

a. Fully charging the propeller before use

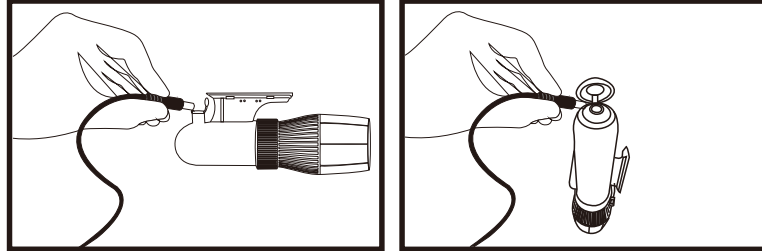

b. Fully charging the remote control for use

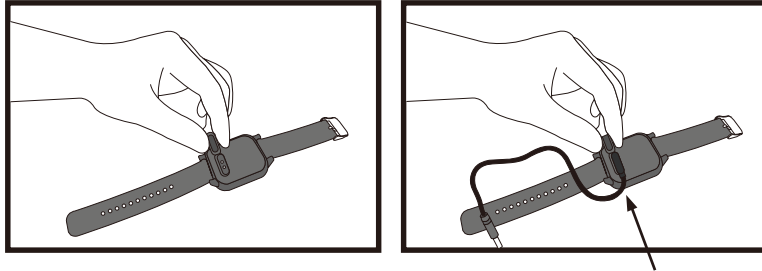

c. Install the propeller on a SUP

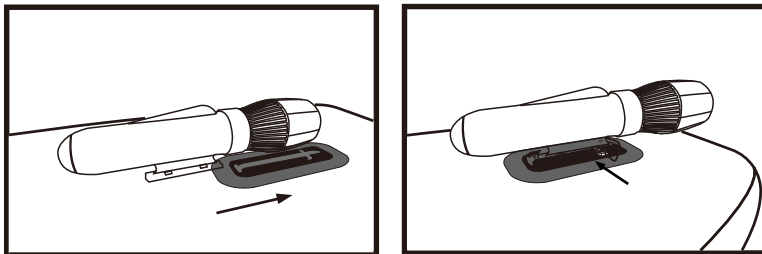

2. Using the AQUAJET on your SUP

- Put the SUP with the AQUAJET in the water and make sure that you have enough space and that you do not hit any obstacles.
- Stand or kneel on the SUP and take the remote control.
- Attach the remote control in case you fall off.

IV . AQUAJET In Use

3. Install diving handles and use thrusters on other hulls.
 - a. When installing the diving handle, it is necessary to install pins in both slots and remove them. The strap of the remote control watch is installed inside the waterproof box of the diving handle, Tighten the waterproof box and check its firmness. Before entering the water, wear a slip rope to prevent pushing. The inlet accidentally disengaged in the water.

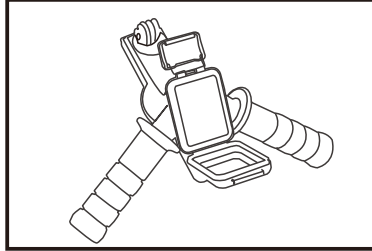

① Diving handle

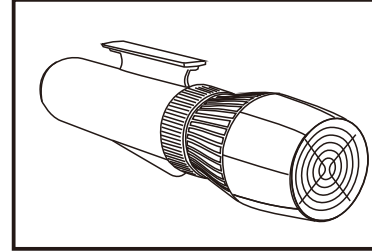

② Thruster host

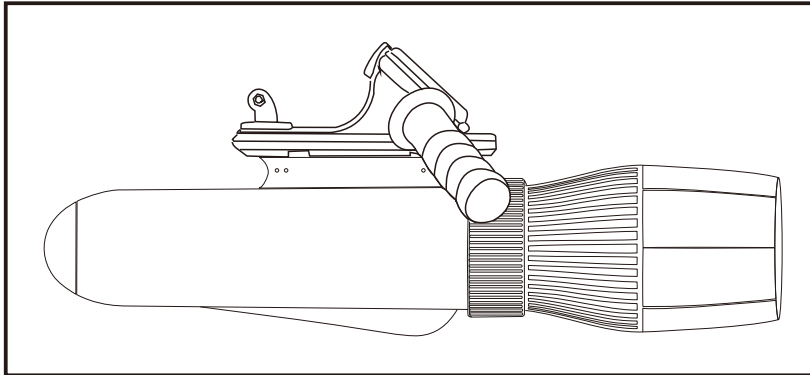

③ Connect the diving handle to the thruster host and secure it with a locking pin

- b. When using thrusters on other hulls or equipment, it is important to ensure that there are. The thruster slot device can only be used after being firmly installed to ensure that the thruster will not detach.

V. Remote Control

Status display and operating instructions

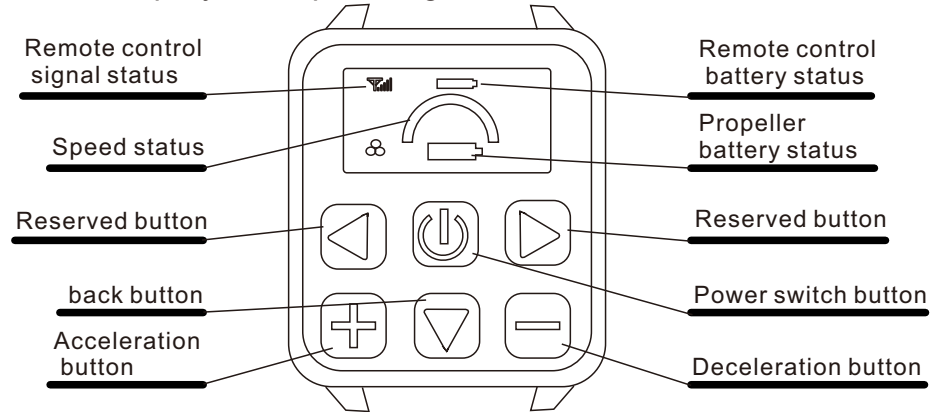

Schematic diagram of control

Remote Control and Host Pairing Signal: In the charging mode of the host, plug and unplug the DC charging plug twice in a row. Wait until you hear a beep sound from the host, then press any key on the remote control to complete the pairing. If the pairing is unsuccessful, repeat the above steps until a successful pairing is achieved.

Remote Control Signal Status: After successful pairing, the signal tower icon will be displayed on the remote control screen, indicating that the remote control has established a signal connection with the host. If the remote control loses signal connection with the host, the remote control screen will display an "x" icon. If the signal connection is lost while the host is running and continues for 1 minute, the host will automatically shut down.

Power Switch Button: In the case of successful pairing, double-click the power switch button on the remote control to turn on the host. The host defaults to the forward state and the default speed ratio is low speed. Please pay attention to the display information on the remote control screen to confirm the status of the host. To turn off the host, doubleclick the power switch button again. It is important to note that when the host is in charging mode, the battery is in a protected state and the thruster cannot be started.

Propeller Host Battery Status: Before each use, please ensure that the host battery is fully charged. During use, please frequently check the battery level displayed on the remote control screen and reserve enough power to ensure a safe return.

Speed Ratio Status: When the host is turned on, the default speed ratio is 20% low speed, with a minimum speed of 10% and a maximum speed of 100% full speed. If the host suddenly shuts down while running at full speed, it may be due to overcurrent protection or overtemperature protection being triggered. You can try restarting the host or wait a moment before starting it again, and the problem may be resolved.

VI. After Using AQUAJET

1. Flush the propeller to prevent corrosive water from damaging the propeller.
2. Try to put it in a dark place to dry, and do not expose it to the sun to prevent damage to the battery.
3. Store in a dark place after cooling and drying for reuse next time. If it is not used for a long time, please charge the remote control and the host and store them again (the chip will consume the reserved power and cause the remote control to crash).

VII. Thruster model parameters

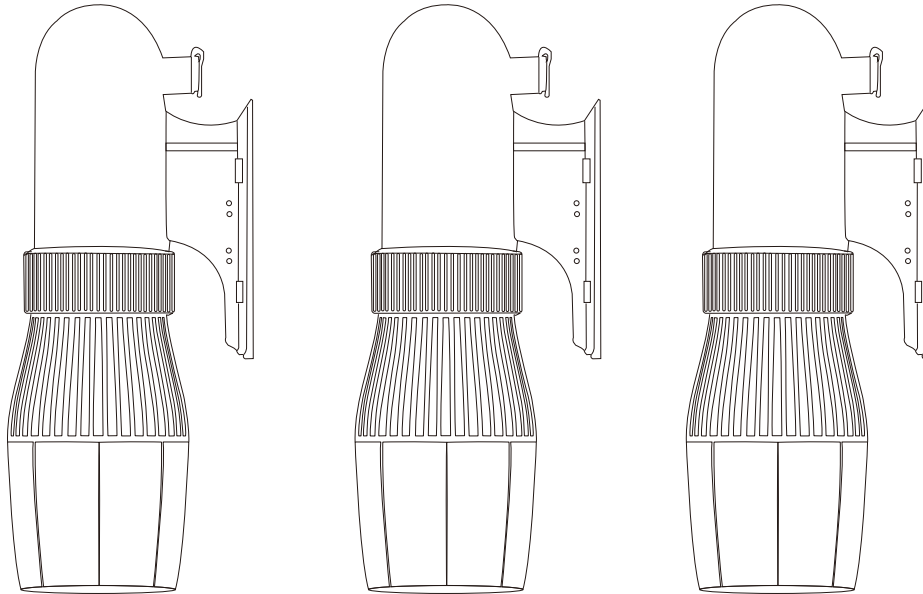

Thruster model	LXHD2-1
model	Brushless motor 6020
battery level	55.5Wh (2500mAh)
Endurance	40-25 Minutes/time
Approximate speed	2-4KM/H

Thruster model	LXHD2-2
model	Brushless motor 6020
battery level	97.68Wh (4400mAh)
Endurance	75-40 Minutes/time
Approximate speed	2-4KM/H

Thruster model	LXHD2-3
model	Brushless motor 6020
battery level	128.76Wh (5800mAh)
Endurance	100-51 Minutes/time
Approximate speed	2-4KM/H

VII. Thruster model parameters

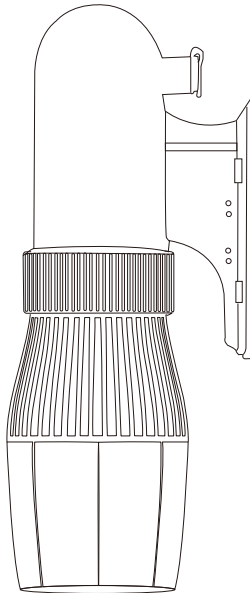

Thruster model	LXHD3-1
model	Brushless motor 6040
battery level	97.68Wh (4400mAh)
Endurance	60-20 Minutes/time
Approximate speed	3-7KM/H

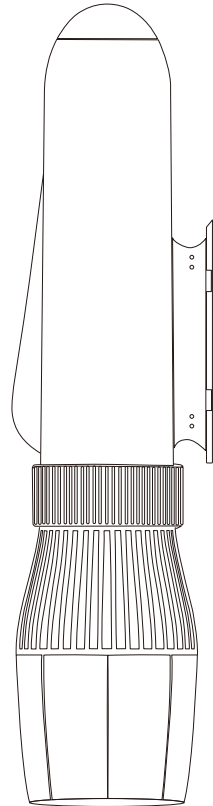

Thruster model	LXHD3-2
model	Brushless motor 6040
battery level	166.5Wh (7500mAh)
Endurance	100-35 Minutes/time
Approximate speed	3-7KM/H

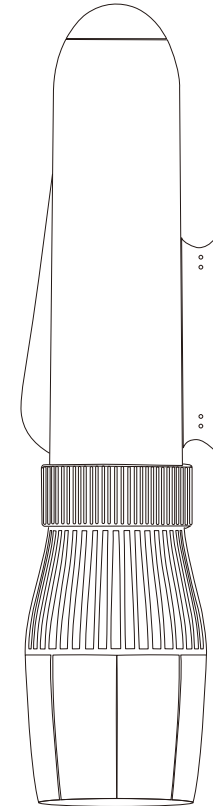

Thruster model	LXHD3-3
model	Brushless motor 6040
battery level	222Wh (10000mAh)
Endurance	130-50 Minutes/time
Approximate speed	3-7KM/H

VII. Thruster model parameters

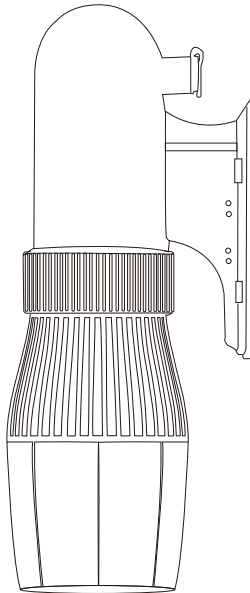

Thruster model	LXHD5-1
model	Brushless motor 6050
battery level	97.68Wh (4400mAh)
Endurance	60-15 Minutes/time
Approximate speed	3-9KM/H

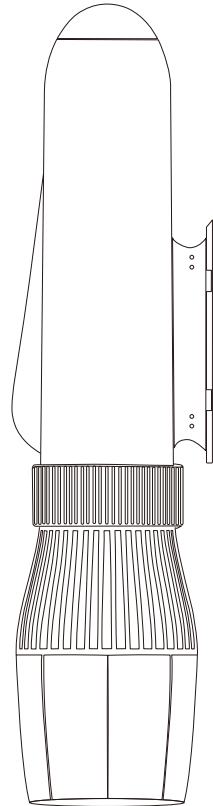

Thruster model	LXHD5-2
model	Brushless motor 6050
battery level	222Wh (10000mAh)
Endurance	130-40 Minutes/time
Approximate speed	3-9KM/H

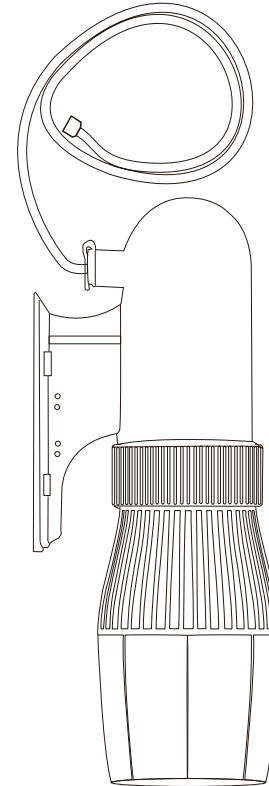

Thruster model	LXHD5-3
model	Brushless motor 6050
battery level	External 24V battery
Endurance	
Approximate speed	3-9KM/H

VII. Thruster model parameters

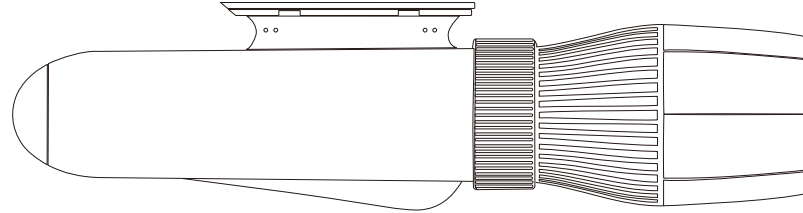

High speed diving specialized type

Thruster model	LXHD7-1
model	Brushless motor 6070
battery level	321Wh (14500mAh)
Endurance	160-35 Minutes/time
Approximate speed	3-11KM/H

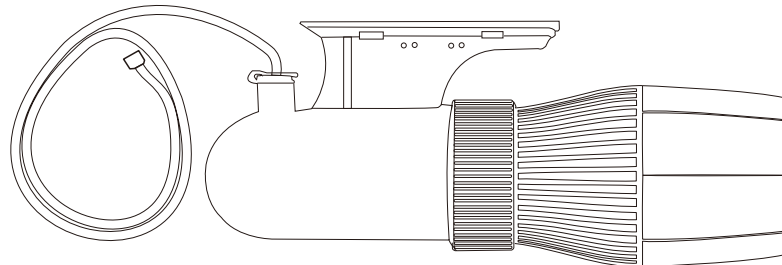

High speed motorboat special type (external battery)

Thruster model	LXHD7-2
model	Brushless motor 6070
battery level	External 24V battery
Endurance	
Approximate speed	3-11KM/H

This device complies with Part 15 of the FCC Rules. Operation is subject to the following two conditions: (1) this device may not cause harmful interference, and (2) this device must accept any interference received, including interference that may cause undesired operation

NOTE: This equipment has been tested and found to comply with the limits for a Class B digital device, pursuant to Part 15 of the FCC Rules. These limits are designed to provide reasonable protection against harmful interference in a residential installation. This equipment generates, uses and can radiate radio frequency energy and, if not installed and used in accordance with the instructions, may cause harmful interference to radio communications. However, there is no guarantee that interference will not occur in a particular installation.

If this equipment does cause harmful interference to radio or television reception, which can be determined by turning the equipment off and on, the user is encouraged to try to correct the interference by one or more of the following measures:

- Reorient or relocate the receiving antenna.
- Increase the separation between the equipment and receiver.
- Connect the equipment into an outlet on a circuit different from that to which the receiver is connected.
- Consult the dealer or an experienced radio/TV technician for help.

Warning: changes or modifications not expressly approved by the party responsible for compliance could void the user's authority to operate the equipment

The device has been evaluated to meet general RF exposure requirements, the device can be used in portable exposure condition without restriction