

Front Panel

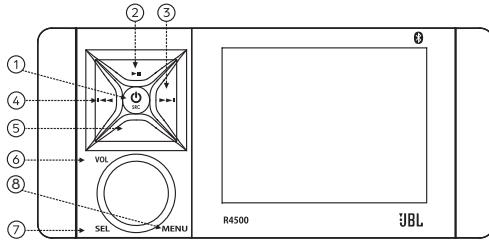

1. POWER ON/OFF BUTTON



MODE FUNCTION BUTTON



2. PLAY/PAUSE BUTTON



MUTE FUNCTION BUTTON



3. TRACK UP / TUNE UP / FAST FORWARD



4. TRACK DOWN / TUNE DOWN / REWIND



5. RETURN BUTTON

VOL

6. VOLUME INCREASE / DECREASE KNOB

SEL

7. SELECT FUNCTION KNOB

MENU

8. MENU BUTTON

Wiring Identification

NO	COLOR	DESCRIPTION
A1	BLACK	GROUND
A2	BLUE	AUTO ANT
A3	GREEN	REAR LEFT +
A4	GREEN/BLACK	REAR LEFT -
A5	GRAY	FRONT RIGHT +
A6	GRAY/BLACK	FRONT RIGHT -
A7	VIOLET	REAR RIGHT +
A8	VIOLET/BLACK	REAR RIGHT -
A9	RED	ACC
A10	WHITE	FRONT LEFT +
A11	WHITE/BLACK	FRONT LEFT -

Power & Speaker
Connection

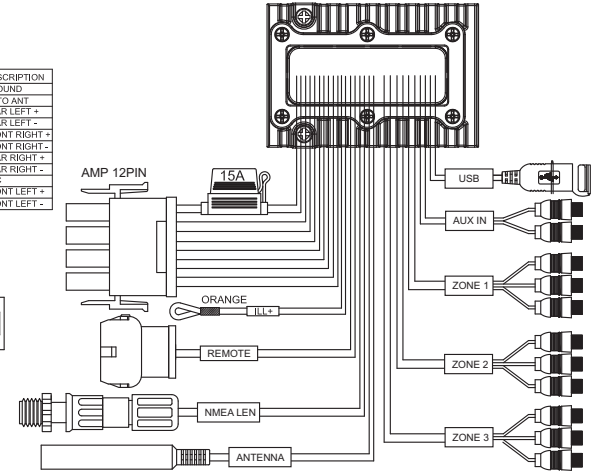
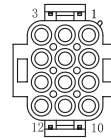

INSTALLATION BULLETIN

To avoid possible water ingress into wire harness area, route the harness in the downward direction as shown below on the left. Do not route the harness in the upward direction as shown on the right.

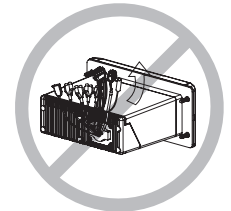
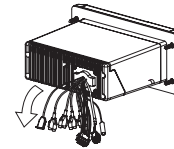

Auxiliary Input Mode

1. To Select AUX mode

Press RETURN button to display Home Menu, then turn VOL knob and press it to select AUX mode. (The foreground pop up icon refers to the source changing.)

Or repeat press SRC button to select the desired mode.



The use of auxiliary mode allows you to play the portable music device through the headphone jack.

Note: An additional accessory/adaptor must be purchased in order for this to happen.

Prospec's part, SEAMINI2 or SEAUSBMINI36 fulfills this option.

RCA OUTPUT

Description: The use of RCA outputs allow an amplifier or subwoofer to be hooked up.

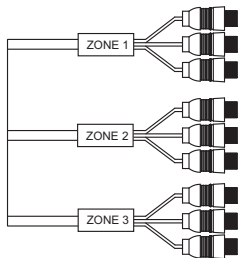

Each RCA has a Left Channel, Right Channel and a subwoofer channel which distinguish by the O-Ring on the jack.

- Red: Right Channel

- White: Left Channel

- Black: Subwoofer

The subwoofer was set as 80hz low pass filter and the subwoofer gain level for each zone can be adjusted in Audio Setting (refer to page 6).

General Operation

1. Power On/Off and Mode Switch

Press for the first time to turn the unit on.

Press and hold for more than 3 seconds to turn the unit off.

With unit powered on, press repeatedly to switch mode as follows:

FM --> AM --> WB --> BT MUSIC --> USB --> AUX.

2. Play or Pause / Mute

In BT MUSIC and USB mode, press repeatedly to play or pause track.

In Radio and AUX mode, press to mute sound output, press again to resume.

3. Track Up / Tune Up / Fast Forward

In Radio mode, press to work as Auto Tune. Press and hold to activate Manual Tune, then press repeatedly to tune by step. (It will revert to auto tune status if you do not press this button within 5s after Manual tune is activated.)

In BT MUSIC or USB mode, press to select the next track.

In USB mode, press and hold to fast forward.

4. Track Down / Tune Down / Rewind

In Radio mode, press to work as Auto Tune. Press and hold to activate Manual Tune, then press repeatedly to tune by step. (It will revert to auto tune status if you do not press this button within 5s after Manual tune is activated.)

In BT MUSIC or USB mode, press to select the previous track.

In USB mode, press and hold to rewind.

5. Return

In any source playing status, press to back to Home Screen.

In Sub-menu, press to back to previous display.

In Sub-menu, press and hold over 3s to back to Home Screen directly.

6. VOL Volume Increase / Decrease Knob

In all modes, turn the knob clockwise or counter clockwise to adjust master volume level (0~45) in any playing status. (See next page for zone volume control).

7. SEL Select Knob

In menu selection mode, press to confirm selection.

8. MENU Menu Knob

In source playing status, press to activate sub-menu of current playing source. Press and hold over 3s to enter Settings directly. (See details in each source operation.)

General Operation (SETUP)

1. Master / Zone Volume Control

Turn the knob clockwise or counter clockwise to adjust master volume level (0~45) in any playing status, each zone volume will change simultaneously. To adjust a Zone volume separately, press SEL knob at volume display status, turn VOL knob to select among ZONE1, ZONE2 and ZONE3, press SEL knob at desired zone and turn the knob again to adjust zone volume level.



2. Enter SETUP

There are two ways to enter Setup.

- Press RETURN button to display Home Screen, then turn VOL knob and press SEL knob when SETUP popup.
- Or enter SETUP by press and hold MENU knob for 3s while source playing. Turn VOL knob to move among Audio, System, Bluetooth and About, press SEL knob at desired setup.

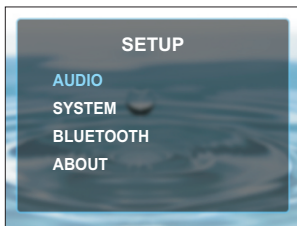

Note: If no operation occurs, it will revert back after 5s.

2-1. Audio Settings

Press SEL knob at AUDIO being highlighted to enter Audio Settings. Turn VOL knob and push SEL knob to select sub-features, then turn VOL knob to adjust the level of each sub-features.

BASS: Minimum -7 to maximum +7.

MIDRANGE: Minimum -7 to maximum +7.

TREBLE: Minimum -7 to maximum +7.

BALANCE: L10 (full left) to R10 (full right).

PRESET EQ: OFF, FLAT, JAZZ, POP, CLASSIC, ROCK, VOCAL, TECHNO.

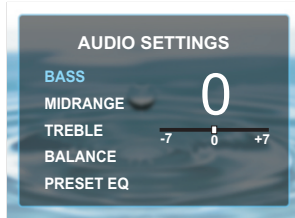

iPod/iPhone Operation

Use of the Made for Apple badge means that an accessory has been designed to connect specifically to the Apple product(s) identified in the badge, and has been certified by the developer to meet Apple performance standards. Apple is not responsible for the operation of this device or its compliance with safety and regulatory standards.

Please note that the use of this accessory with an Apple product may affect wireless performance.

iPhone and Lightning are trademarks of Apple Inc., registered in the U.S. and other countries.

Made for iPhone 11, iPhone 11 Plus, iPhone X, iPhone 8, iPhone 8 Plus, iPhone SE. Minimum iOS 10.3.2 or later.

1. Connect

Once you connect an iPod/iPhone to the USB input, it will read the files automatically. It can take up to 30 seconds to load all of the files, so please be patient. The more music you have, the longer it will take.

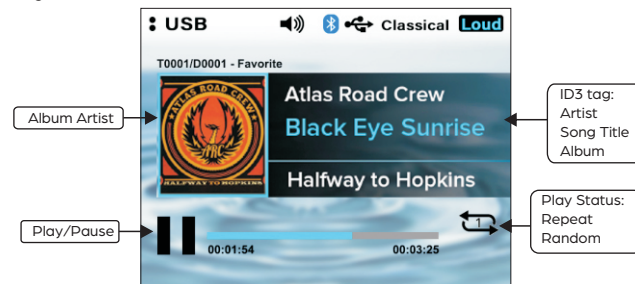

2. iPod/iPhone Operations

Play/Pause, Track Up/Down, Fast Forward, Rewind,

File List, Repeat, Random

All above operations are the same as USB section.

Note: Please make sure the iPod/iPhone cable is connected correctly.

It is recommended to use the original cable for connection.

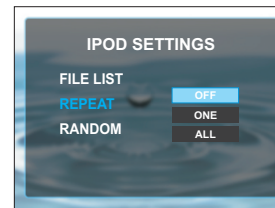

USB Section Operation

5. FILE LIST (Folder / File Search)

While USB is playing, press MENU button to show USB settings, press SEL knob to enter file list, it will display all the tracks in current playing folder.

- To select other tracks in current folder, turn VOL knob and press it at desired track.
- To select the track in other folders, press SEL button at the desired folder.

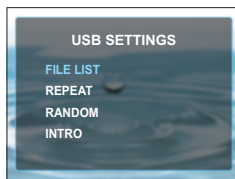

6. Repeat play

While USB is playing, press MENU button to show USB settings, turn VOL knob and preset it at Repeat, then turn VOL knob to select one, folder or all.

- Select Repeat One to play current track repeatedly.
- Select Repeat Folder to repeatedly play the tracks in current folder.
- Select Repeat All to repeatedly play all the tracks in drive.

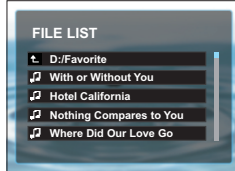

7. Random play

While USB is playing, press MENU button to show USB settings, turn VOL knob and press at Random, then turn VOL knob to select off, folder or all.

- Select Random off to disable Random play.
- Select Random Folder to play the tracks in current folder in a random sequence.
- Select Random All to play all the tracks in the USB device randomly.

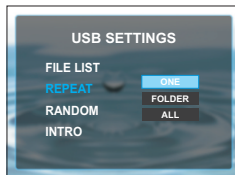

8. Intro Play

While USB is playing, press MENU button to show USB settings, turn VOL knob and press it at Intro, then turn VOL knob to select off, folder, or all.

- Select Intro off to disable Random play.
- Select Intro Folder to play the first 10s of the tracks in current folder.
- Select Intro All to play the first 10s of all the tracks in current directory.

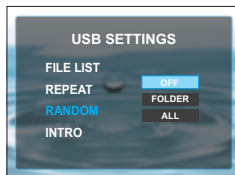

General Operation (SETUP)

LOUDNESS: OFF, ON.

SUB LEVEL: At Sub Level, turn VOL knob to toggle among ZONE1, ZONE2 or ZONE3 and push SEL knob at desired zone; turn VOL knob again to adjust the Sub Level from Minimum 0 to maximum 15.

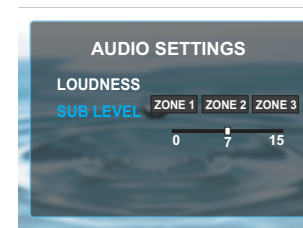

2-2. System Settings

Press SEL knob at SYSTEM being highlighted to enter System Settings.

Press VOL knob to select sub-features, then turn VOL knob to adjust the level of each sub-features.

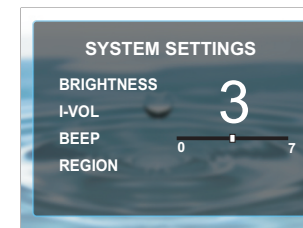

BRIGHTNESS: This feature controls the brightness of the display panel. It is adjustable from 0 to 7.

I-VOL: This feature controls the initial volume level of next power on. Turn the knob to adjust volume level (0~45) in any playing status. If the volume is set less than I-VOL, it will memorize the volume set after restarting the unit. If the volume is set higher than I-VOL, it will memorize the I-VOL after restarting the unit.

BEEP: This feature controls the beep sound when button was pressed.

BEEP ON: You can hear the beep sound each time you press the buttons.

BEEP 2ND: You will only hear the beep sound when the buttons are held down for more than 2 seconds.

BEEP OFF: You will not hear the beep sound when you press the buttons.

REGION: The Tuner Region is optional for EURO, USA, JAPAN.

(Note: with wrong Region selected, the tuner reception might be affected.)

General Operation (SETUP)

2-3 Bluetooth Settings

Press SEL knob at BLUETOOTH being highlighted to enter Bluetooth Settings. Turn VOL knob to select sub-features, then turn VOL knob to adjust the level of each sub-features.

AUTO CONNECT: If you don't want to auto connect to last paired phone, just set Auto Connect to OFF. It will default at ON.

DEVICE NAME: R4500. Select correct Device Name when you search for Bluetooth connection on your phone.

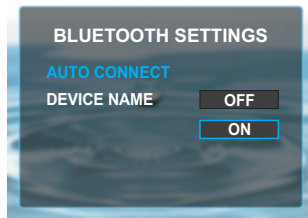

2-4. About

Press SEL knob at ABOUT being highlighted, it will show the firmware information of the product. With firmware information being displayed, press and hold the VOL knob for more than 5 seconds to display **Factory Reset**. Press SEL knob to confirm, the unit will be initialized and restarted.

Note: Once Factory Reset is carried out, prior presets will be cleared, and you will need to setup the features and Global Presets once again.

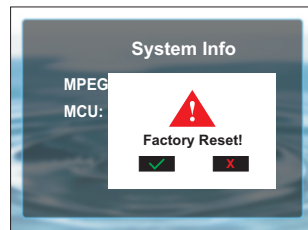

USB Section Operation

1. To Select Bluetooth mode

Press RETURN button to display Home Menu, then turn VOL knob and press it to select USB mode. (The foreground pop up icon refers to the source changing.)

Or repeat press SRC button to select the desired mode.



2. USB Screen Description

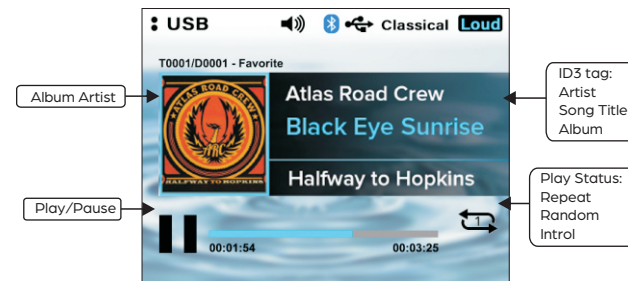

3. Play / Pause

While USB is playing, press the PAUSE button to pause the playback, and press again to resume playback.

Note: **||** refers to PAUSE; **▶** refers to PLAY.

4. Track Up/Down

While USB is playing, press the TUNE Up/Down button to select the next or previous track. To fast forward or rewind, press and hold TUNE Up/Down button.

Bluetooth Section Operation

3. Pair BT Device

In Bluetooth source, pick "R4500" option on your Bluetooth enabled device.
(if you are prompted for a password, the code entered will be "0000 or 1234".)

Note: The Bluetooth pairing only happens with unit in Bluetooth mode.

4. Play/Pause Play

Once the BT device being paired is successful, music will begin to play.

Note: For some Bluetooth enabled phones, you may need to activate play from your phone first. It depends on the phone itself.

While BT Music is playing, press the PAUSE button to pause the playback, and press it again to resume playback.

Note: **||** refers to PAUSE; **▶** refers to PLAY.

5. Disconnect

In BT Music playing mode, in order to disconnect the BT device, press MENU to display Bluetooth Settings, turn VOL knob and press it at Disconnect.

Note: When your BT device battery is at low charge, the Bluetooth connection may occasionally be lost. To maintain good connectivity ensure that your BT device battery is adequately charged.

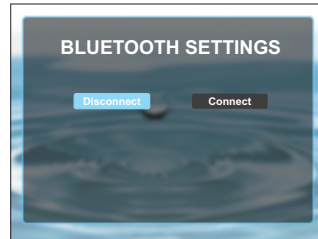

6. Connect

With BT device paired OK, but disconnected, if you want to re-establish the BT connection, press MENU to display Bluetooth Settings, turn VOL knob and press it at Connect. It will send a connect request to the last paired device.

Note: With the Bluetooth connection disconnected, once you power on the unit next time, you should go into Bluetooth mode, then it will establish the Bluetooth connection automatically. Sometimes, with Bluetooth mode not in use for over 1 hour, when you switch to BT mode again, it might take some time (5~10s) to re-establish the connection by itself.

Radio Section Operation

1. To Select Radio mode

Press RETURN button to display Home Screen, then turn VOL knob and press it to select AM, FM or WB mode. (The foreground popup icon refers to the source changing.)

Or simply repeat press SRC button to select the desired mode.



2. Radio Screen Description

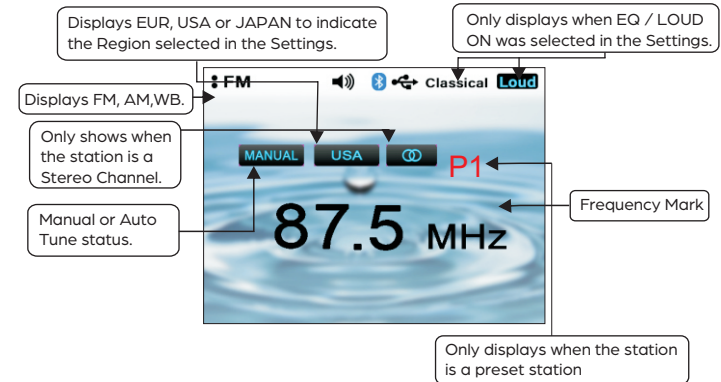

Radio Section Operation

3. Auto Tuning

In FM, AM, WB playing mode, press Tune up or down button to activate auto tune. This results in automatically stopping at next station of sufficient signal strength.

4. Manual Tuning

In FM, AM, WB playing mode, long press Tune up or down button for 2s. This will activate manual tune with MANUAL display on the top area. Then repeatedly press Tune up or down button to tune frequency by steps.

Note: Radio will revert back to AUTO tune mode after 5s without operation.

5. Station Save

At your favorite station, press the MENU knob to enter Tuner Settings, press VOL knob at SAVE AS PRESET to show the Global Preset list, then turn VOL knob to select a preset No. and press it to save the station into Preset List. The Preset No. will display once the station is saved.

Note: It will revert back to previous display after 5s without operation.

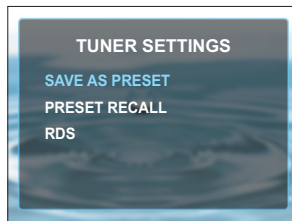

6. Recall Preset Station

In Radio (FM, AM, WB) or SXM source, press the MENU knob to enter Tuner Settings, turn VOL knob and press at PRESET RECALL to show the Global Preset list, turn the knob and press again at a desired Preset station. Once a preset station was selected, it will switch to source playing with the selected station information displayed.

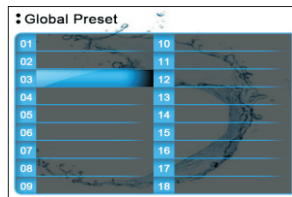

7. RDS Functions

Press MENU button in Radio source playing to display the Tuner Settings screen, turn VOL knob and press it at RDS, then turn VOL again and press it to select RDS on or off.

With RDS on selected, the station information, such as station name, title, etc would be displayed if the received station is a RDS station.

Bluetooth Section Operation

1. To Select Bluetooth mode

Press RETURN button to display Home Menu, then turn VOL knob and press it to select Bluetooth mode. (The foreground pop up icon refers to the source changing.)

Or repeat press SRC button to select the desired mode.



2. Bluetooth Screen Description



Note: the Album / Artist may sometimes not display, it is subjects to the BT Device that's connected.