

# INF PRV315.2 Owner's Manual



**Prospec Electronics**  
Sound Systems For The Outdoor Enthusiast

This product is serviced exclusively by Prospec Electronics Inc. and must be returned to Prospec for in and out of warranty repairs. It can not be serviced under warranty by other Infiniti service centers.

For service contact us :  
3325 South Morgans Point Road Mt Pleasant SC 29466

Tel 843-849-9037

Or visit: [www.prospecelectronics.com](http://www.prospecelectronics.com)

\*This stereo should not be washed with a pressure washer neither should it be washed with chemicals. A wet sponge or damp cloth will suffice.\*



**Prospec Electronics**  
Sound Systems For The Outdoor Enthusiast

3325 South Morgans Point Rd. | Mt. Pleasant, SC 29466

P: 843-849-9037 | [www.prospecelectronics.com](http://www.prospecelectronics.com)

## Troubleshooting

\*Note: In many respects, a stereo acts much like a computer and occasionally requires a reboot. In the unlikely event of product malfunction, a reset can usually fix the issue. For software reset operation, please refer to page 8.

Issue	Cause	Solution
No power	<ol style="list-style-type: none"> <li>1. Incorrect wiring</li> <li>2. Fuse is blown</li> <li>3. Low battery voltage</li> </ol>	<ol style="list-style-type: none"> <li>1. Double check wiring</li> <li>2. Replace fuse</li> <li>3. Check voltage of vehicle battery with multimeter. Voltage must be at least 11V.</li> </ol>
No Sound	<ol style="list-style-type: none"> <li>1. Speaker connection came loose</li> <li>2. Bad speaker</li> <li>3. Output blown</li> <li>4. Volume too low on media device</li> </ol>	<ol style="list-style-type: none"> <li>1. Double check connections.</li> <li>2. Replace bad speaker with known good speaker and connect.</li> <li>3. Send unit in for repair.</li> <li>4. Increase volume of media device</li> </ol>
No Reception	<ol style="list-style-type: none"> <li>1. Antenna not firmly seated in socket</li> </ol>	<ol style="list-style-type: none"> <li>1. Insert firmly</li> </ol>
USB stick not reading	<ol style="list-style-type: none"> <li>1. File must be a mp3 or wma file</li> </ol>	<ol style="list-style-type: none"> <li>1. Convert format to mp3 or mwa.</li> </ol>
While in Bluetooth mode:		
No Connection	<ol style="list-style-type: none"> <li>1. You are not connected to the "PRV315.2" address on your portable media device.</li> <li>2. Out of range</li> <li>3. The connection is already in use.</li> </ol>	<ol style="list-style-type: none"> <li>1. Choose "PRV315.2"</li> <li>2. Bring portable media device closer to the receiver. Device needs to be within 30'.</li> <li>3. Ask the person who first paired to drop out.</li> </ol>











## Table of Contents

Table of Contents -----	1
Product Description -----	2
Installation Instructions -----	3
Wiring Configuration -----	4
General Function of Buttons -----	5
Sign up Display & Home Menu -----	6
General Operations -----	7
General Settings -----	7
Radio Section Operation -----	9
Bluetooth Section Operation -----	11
USB Section Operation -----	13
AUX Section Operation -----	15
Troubleshooting -----	16

## Product Description

This radio is another forward thinking product from Infinity by Harman. Other Harman brands include JBL, JBL Professional, AKG, Mark Levinson, Harman Kardon, and Revel. Harman was purchased by Samsung in 2016. Prospec Electronics is Harman's exclusive distributor to OEM's in the marine, side by side, golf car, and hot tub industries. Our products range from mechless receivers, amplifiers, subwoofers, speakers, and other accessories. Prospec is located in Mount Pleasant, S.C., a stone's throw away from Charleston, S.C. Should you need our expertise, please do not hesitate to give us a call. We're all about the music and this music should resonate from components verified to complement your hard earned off road purchase.

The PRV315.2 incorporates the following features:

-  AM/FM/WB/ RBDS
-  Bluetooth Audio Streaming with ID tagging
-  USB input and control-for USB drives only
-  Auxiliary input
-  3.5" color TFT screen / Waterproof faceplate
-  50W x 4 amplifier / 2 ohm stable
-  Wired remote option
-  U.S., European and Japan tuning
-  Charging through USB
-  3 pair of RCA output including subwoofer output
-  Video input

## AUX Section Operation

### 1. To Select AUX mode

At Home Menu, press TUNE Up or Down to move the highlight to AUX source, then press ENTER button to go into the AUX mode. You can also press SRC button to enter AUX mode.

Note: highlight movement indicated by the icon background change to light blue.



The use of auxiliary mode allows you to play the portable music device through the headphone jack.

Note: An additional accessory/adaptor must be purchased in order for this to happen. Prospec's part, SEAMINI2 or SEAUSBMINI36 fulfills this option.



## USB Section Operation

### 4. Track Up/Down

While USB is playing, press the button to select the next or previous track. To fast forward or rewind, press and hold TUNE button.

### 5. Repeat play

While USB is playing, press MENU button to show USB settings, turn VOL knob and press it at Repeat, then turn VOL knob to select one, folder or all.

- Select Repeat One to play current track repeatedly.
- Select Repeat Folder to repeatedly play the tracks in current folder.
- Select Repeat All to repeatedly play all the tracks in USB the device.

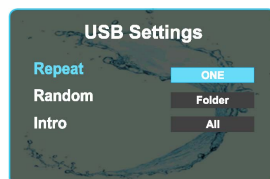

### 6. Random play

While USB is playing, press MENU button to show USB settings, turn VOL knob and press it at Random, then turn VOL knob to select off, folder or all.

- Select Random off to disable Random play.
- Select Random Folder to play the tracks in current folder in a random sequence.
- Select Random All to play all the tracks in the USB device in a random sequence.

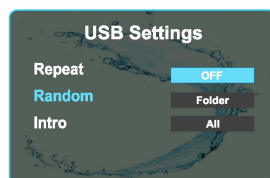

### 7. Intro Play

While USB is playing, press MENU button to show USB settings, turn VOL knob and press it at Intro, then turn VOL knob to select off, folder, or all.

- Select Intro off to disable Intro play.
- Select Intro Folder to play the first 10s of the tracks in current folder.
- Select Intro All to play the first 10s of all the tracks in the USB device.

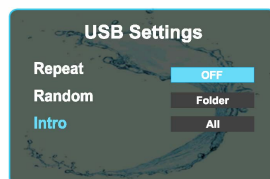

### 8. P.LIST (Folder / File Search)

While USB is playing, press P.LIST button to enter track search mode, it will display all the tracks in current playing folder.

- To select other tracks in current folder, just simply turn VOL knob and press it at desired track.
- To select the track in other folders, press Return button at the track display screen, it will back to folder display, turn VOL knob and press the knob at desired folder, repeat above operation until a desired track selected.



## Installation

A mounting gasket has been added inside the package for convenience. Trace along the outside edge of the gasket thus revealing your cutout.

### Mounting Illustration

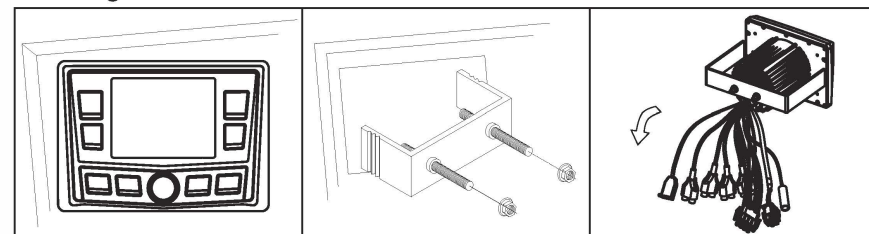

1. Avoid installing stereo below cupholders! Make sure mounting substrate is flat to avoid flexing of the plastic.
2. Use the back bracket and studs to affix the unit. Install the U bracket behind the unit, using two nuts per bolt for ultra hold.
3. To avoid possible water ingress into wire harness area, route the harness in the downward direction as shown above.

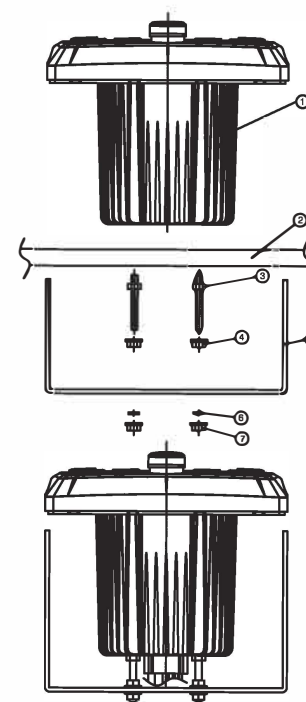

NO.	PART DESCRIPTION
1	RADIO
2	MOUNTING PLATE
3	MOUNTING STUDS
4	JAMB NUTS
5	MOUNTING BRACKET
6	SPRING WASHER
7	OUTER NUTS

#### Instructions:

1. Install jamb nuts (4) loosely on mounting studs (3), so they will not touch mounting brackets (5) when installed.
2. Slip mounting bracket (5) on and make flush with mounting surface (2).  
DO NOT TIGHTEN
3. Snug spring washer (6) and outer nuts (7) against mounting plate (2).  
DO NOT TIGHTEN
4. Position jamb nuts (4) approximately 1/16" from mounting bracket.
5. Tighten outer nuts (7) completely.

## Wire Configuration

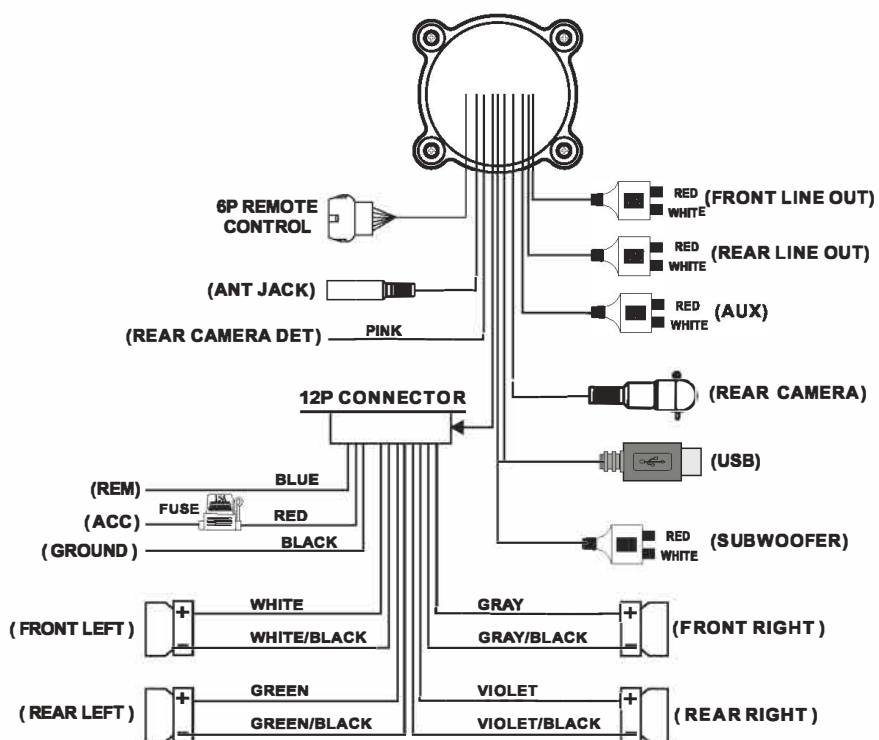

### NOTE:

1. When wiring, the red lead is recommended to be wired to ACC/ignition power lead.
2. Make sure that the black wire on the wiring harness is connected to a good ground point on the boat. If the chassis of the boat is used as a ground point, make sure that the surface is scraped clean of paint before attaching the wire to it. It is recommended to connect the black ground wire directly to negative terminal (-) of the boat battery.
3. Before wiring your system, disconnect your boat battery's positive (+) cable. This helps prevent damage in case of a short.

## USB Section Operation

### 1. To Select USB mode

At Home Screen, turn VOL knob and press knob while on USB to select USB source. (The bigger pop up icon refers to the source changing.) Or simply repeat press SRC button to select the desired source.  
 Note: This input is designed to read and play USB drives (mp3 and wma files), not media or phones.



### 2. USB Screen Description

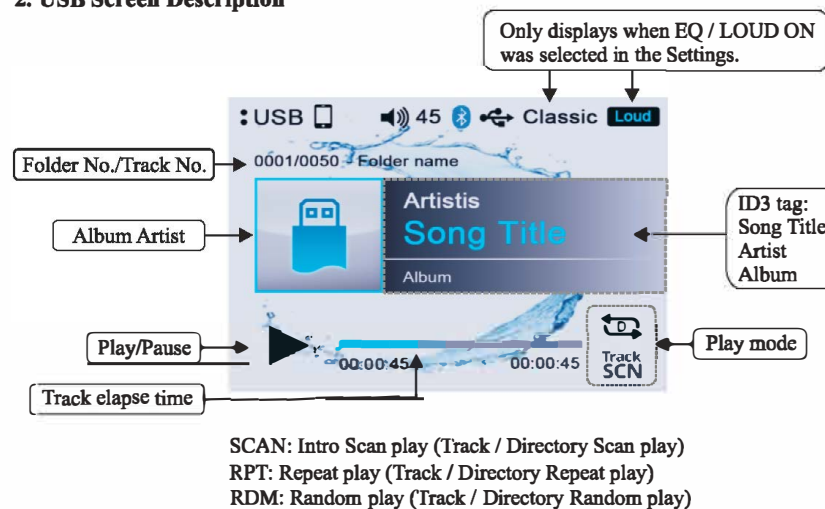

### 3. Play/Pause Play

While USB is playing, press the PAUSE button to pause the playback, and press again to resume playback.  
 Note: **||** refers to PLAY; **▶** refers to PAUSE.

## Bluetooth Section Operation

### 4. Play/Pause Play

Once the BT device being paired is successful, music will begin to play.

Note: For some Bluetooth enabled phones, you may need to activate play from your phone first. It depends on the phone itself.

While BT Music is playing, press the PAUSE button to pause the playback, and press it again to resume playback.

Note: **||** refers to PLAY; **▶** refers to PAUSE.

### 5. Disconnect

In BT Music playing mode, in order to disconnect the BT device, press MENU to display Bluetooth Settings, turn VOL knob and press it at Disconnect.

Note: When your BT device battery is at low charge, the Bluetooth connection may occasionally be lost. To maintain good connectivity ensure that your BT device battery is adequately charged.

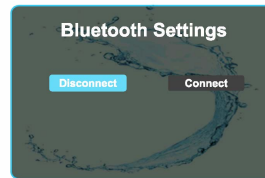

### 6. Connect

With BT device paired but disconnected, if you want to re-establish the BT connection, simply press MENU to display Bluetooth Settings, turn VOL knob and press it at Connect. It will send a connect request to the last paired device, confirm on BT device to establish BT connection.

Note: With the Bluetooth connection disconnected, once you power on the unit next time, you should go into Bluetooth mode, then it will establish the Bluetooth connection automatically.

Sometimes, with Bluetooth Source not in use for over 1 hour, when you switch to BT Source again, it might take sometime (5~10s to re-establish the connection by itself).

#### FCC Statement:

This device complies with Part 15 of the FCC rules. Operation is subject to the following two conditions: 1) this device may not cause harmful interference, and 2) this device must accept any interference received, including interference that may cause undesired operation.

This equipment has been tested and found to comply with the limits for a Class B digital device, pursuant to Part 15 of the FCC rules. These limits are designed to provide reasonable protection against harmful interference in a residential installation. This equipment generates, uses and can radiate radio frequency energy and if not installed and used in accordance with the instructions, may cause harmful interference to radio communications. However, there is no guarantee that interference will not occur in a particular installation. If this equipment does cause harmful interference to radio or television reception, which can be determined by turning the equipment off and on, the user is encouraged to try correct the interference by one or more of the following measures:

- Reorient the receiving antenna.
- Increase the separation between the equipment and receiver.
- Connect the equipment into an outlet on a circuit different from that to which the receiver is connected.
- Consult the dealer or an experienced radio/TV technician for help.

Changes or modifications not expressly approved by the party responsible for compliance could void your authority to operate the equipment.

#### IC STATEMENT

This device contains licence-exempt transmitter(s)/receiver(s) that comply with Innovation, Science and Economic Development Canada's licence-exempt RSS(s). Operation is subject to the following two conditions:

- (1) This device may not cause interference.
  - (2) This device must accept any interference, including interference that may cause undesired operation of the device.
- Cet appareil contient des émetteurs / récepteurs exempts de licence conformes aux RSS (RSS) d'Innovation, Sciences et Développement économique Canada. Le fonctionnement est soumis aux deux conditions suivantes :

- (1) Cet appareil ne doit pas causer d'interférences.
- (2) Cet appareil doit accepter toutes les interférences, y compris celles susceptibles de provoquer un fonctionnement indésirable de l'appareil.

## General Function of Buttons

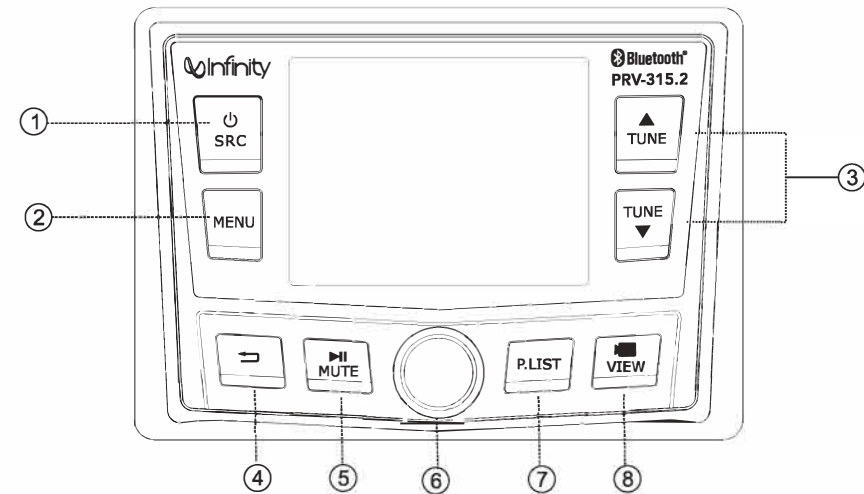

### 1. POWER, SRC button

- With unit off, press to power the unit on.
- With the unit on, press and hold for over 3s to power the unit off.
- Press SRC button to switch modes amongst AM/FM/WB/Bluetooth/USB/AUX.

### 2. MENU button

- In any source playing, short press to display sub-menu of current source.
- In any source playing, press and hold for 2s to enter Settings.

### 3. Tune Up/Down button

- In Radio (FM/AM/WB) mode playing, short press to select the previous or next station.
- In USB/BT Music source playing, short press to select the previous or next track.
- In USB source playing, press and hold to go fast forward or rewind.

### 4. Return button

- In any status, press to return to previous screen.

### 5. Pause, Mute button

- In Radio, AUX source, press to MUTE sound output, press again to resume sound output.
- In USB, BT Music source playing, press to PAUSE playback, press again to resume playback.

### 6. VOL Knob, Selection/Enter button

- At source playing status, turn the knob to increase or decrease volume level.
- In selection status, turn it to scroll move highlight upward/over, and press it to confirm selection.

### 7. P.List button

- In Radio source, press to enter Global Preset List.
- In USB source, press to enter file/folder list.

### 8. VIEW button

- In any source, press to activate Rear Camera display, press it again to exit Camera view.

## Sign Up Display & Home Menu

### 1. Sign up

Once the unit powers on, the introductory home screen appears for 5 seconds, then switches to the last played mode before power off occurred.



### 2. Home Screen (source display)

At Home Screen, turn VOL knob to move to desired source and press ENTER button to enter the desired source.



## Bluetooth Section Operation

### 1. To Select Bluetooth mode

At Home Screen, turn VOL knob and press it to select BT source. (The bigger pop up icon refers to the source changing.)

Or simply repeat press SRC button to select the desired source.



### 2. Bluetooth Screen Description



### 3. Pair BT Device

In Bluetooth source, pick "PRV315.2" option on your Bluetooth enabled device. (if you are prompted for a password, the code entered will be "0000".)

Note: The Bluetooth pairing only happens with unit in Bluetooth source.

## Radio Section Operation

### 3. Auto Tuning

In AM, FM, WB playing mode, press Tune up or down button to activate auto tune. This results in automatically stopping at next station of sufficient signal strength.

### 4. Manual Tuning

In AM, FM, WB playing mode, long press Tune up or down button for 2s. This will activate manual tune with MANUAL display on the top area. Then repeatedly press Tune up or down button to tune frequency by steps.

Note: Radio will revert back to AUTO tune mode after 5s without operation.

### 5. Station Save

At your favorite station, press MENU button to enter Radio Settings, press VOL knob at SAVE AS PRESET to show the Global Preset List, then turn VOL knob to select a preset No. and press it to save the station into Preset List. The Preset No. will display once the station is saved.

Note: It will revert back to previous display after 5s without operation.

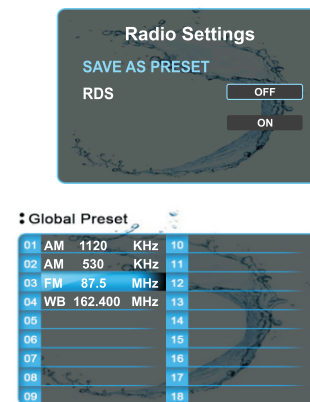

### 6. Recall Preset Station

In Radio (FM, AM, WB) source, press P.LIST button to show the Global Preset List, then turn VOL knob and press it to select the station saved on that Preset No. Once a preset station was selected, it will switch to source playing with the selected station information displayed.

### 7. RDS OFF/ON Selection

Press MENU button in Radio source playing to display the Radio Settings screen, turn VOL knob and press it at RDS, then turn VOL again and press it to select RDS on or off. With RDS on selected, the station information, such as station name, title, etc would be display if the received station is a RDS station.

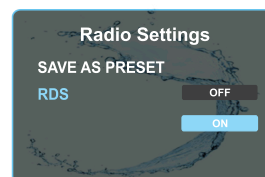

## General Operations

### 1. VOLUME Control

In any source playing status, turn VOL knob to adjust volume level.

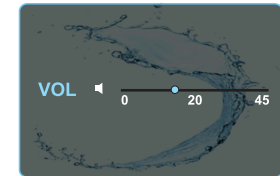

### 2. MUTE Control

In Radio or AUX mode, press MUTE button to mute sound output; press again to resume sound output.



### 3. SETUP

At Home Screen, turn VOL knob and press it to enter SETUP, then turn VOL knob to move amongst Audio, System, Bluetooth, About. Press the knob at desired feature and turn the knob again to adjust the level. Press the knob again to exit current feature adjustment.

Note: If no operation occurs, it will revert back to source playing screen after 5s.

You can also enter Setup by pressing and hold MENU button at any status.

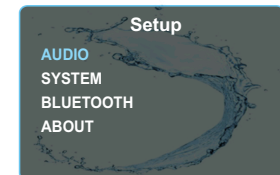

#### 3-1. Audio Settings

At Audio Settings, turn VOL knob and press it to select the sub-item what you desired to adjust, then turn VOL knob to adjust the level, and press VOL knob again to exit current item adjustment. Then you can repeat above operations to adjust other items to desired value.

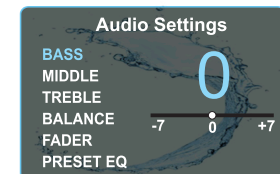

- BASS: Minimum -7 to maximum +7.
- MIDDLE: Minimum -7 to maximum +7.
- TREBLE: Minimum -7 to maximum +7.
- BALANCE : L10 (full left) to R10 (full right).
- FADER: F10 (full front) to R10 (full rear).
- PRESET EQ: OFF, JAZZ, POP, CLASSIC, ROCK, VOCAL.
- LOUDNESS: OFF, ON
- SUBWOOFER GAIN: Minimum 0 to maximum 15.

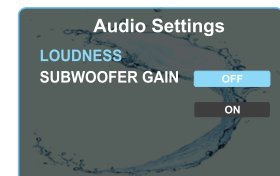



## General Settings

### 3-2. System Settings

At System Settings, turn VOL knob and press it to select the sub-item what you desired to adjust, then turn VOL knob to adjust the level, and press VOL knob again to exit current item adjustment. Then you can repeat above operations to adjust other items to desired value.

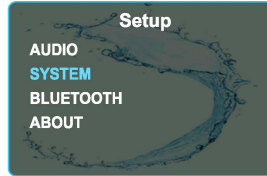

- **BRIGHTNESS:** This feature controls the brightness of the display panel. It is adjustable from 0 to 7.
- **I-VOL:** This feature controls the initial volume level of next power on.
- **BEEP:** This feature controls the beep sound when button was pressed. With beep 2nd selected, you will hear a beep sound when the button was pressed over 2s; With beep on selected, you will hear a beep sound when any button was pressed; With beep off selected, no beep sound will be heard.
- **REGION:** The Tuner Region is optional for EURO, USA, JAPAN.  
(Note: with wrong Region selected, the tuner reception might be affected.)



### 3-3. Bluetooth Settings

At Bluetooth Settings, turn VOL knob and press it to select the sub-item what you desired to adjust, then turn VOL knob to adjust the level, and press VOL knob again to exit current item adjustment.

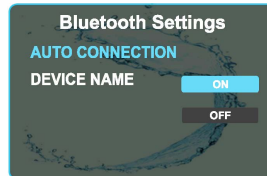

- **Auto Connection:** With ON selected, it will try to connect with the last paired BT device once Bluetooth source selected.
- **Device Name:** PRV315.2 will show once you turn VOL knob to Device Name highlighted.

### 3-4. About

Press VOL knob at About highlighted to show the firmware information of the product.

- **FACTORY RESET:** The unit works like a computer and may occasionally get “stuck”. If encountered, initialize a Factory Reset. Press and hold VOL button for more than 5s to display Factory Reset, then press SEL button to confirm.  
(Note: once Factory Reset is carried out, prior presets will be cleared, and you will need to setup the features and Global Presets once again.)

## Radio Section Operation

### 1. To Select Radio mode

At Home Screen, turn VOL knob and press it to select AM, FM or WB source. (The bigger popup icon refers to the source changing.)  
Or simply repeat press SRC button to select the desired source.



### 2. Radio Screen Description

