

**SL-A710 MASSAGE CHAIR**  
OPERATION INSTRUCTIONS

**SAVE THESE INSTRUCTIONS**

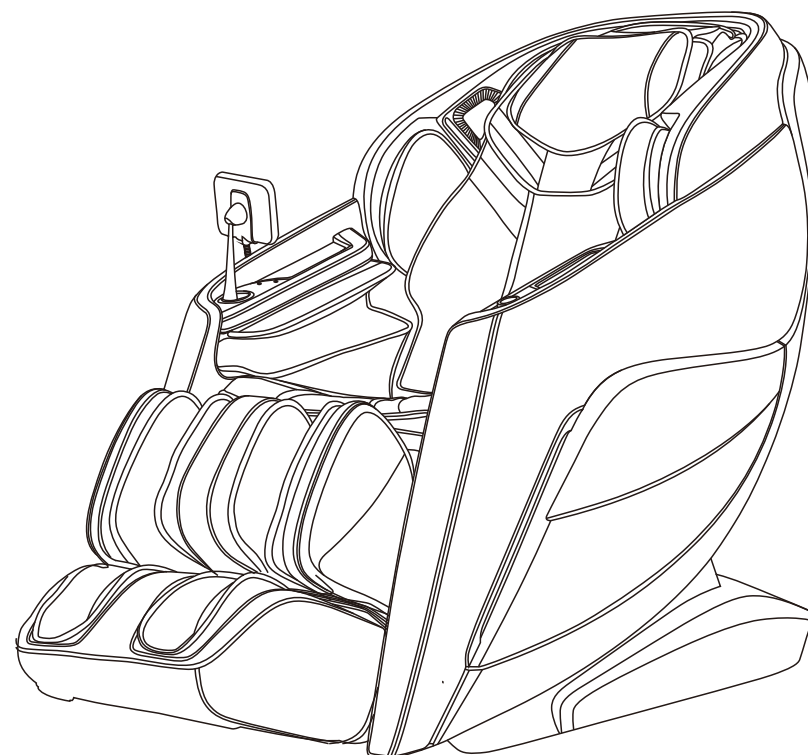

Thanks for purchasing this product. Please read this manual instruction carefully in order to know how to use this product correctly before operation. Please pay more attention to some important safety warning and keep this manual book properly for future use.

Note: Our company reserves the right to change and explain the design of the product. If there is some difference between the product function in market circulation and the description in the manual, it is a normal update of the product, and our company will not inform you otherwise. The specific product function and color shall prevail in kind.

## **CONTENTS**

---

Safety and Maintenance	02-03
Safety Warning	04-08
Name of Components	09
Function	10-11
Touch screen manual controller interface introduction	12
Method of Usage	13
I. Turn on the power supply of this product	13
II. Massage Function Control Operation	13-26
III. Introduction to Armrest Shortcut Keys	27-28
IV. Voice Control Mode	29
V. Turn off power, stop massage	30
VI. Installation Instructions for Armrests	30-31
VII. Installation Instructions for Legrest	32-33
VIII. Installation Instructions for Legrest	34
IX. Use of the shawl	34
X. Pillow Pad and backrest pad's dismounting and use manual	35
XI. Floor Protection	36
XII. Instruction for Movement	36
Legal notices	37
Product Specification	37

## Safety and Maintenance

---

### 1. Important Safety Warnings

- Do not allow children to touch any movable part of this product.
- Use the well-grounded power supply unit suitable for this product.
- Pull out the plug after use or before cleaning to avoid any physical injury or damage to the product.
- Operate this product as instructed in this manual.
- Do not use any parts or accessories which are not recommended.
- Do not use this product outdoors.
- Please read the Operation Instructions carefully before operation.
- Never use this product for any other purpose not listed herein.
- 20 minutes of usage each time is recommended.
- Do not use this product if the leather is broken or damaged.
- Do not use this product if the cover or leather is broken or damaged.
- Do not use this product if the radiator hole is covered or blocked.
- Do not drop anything into this product.
- Never fall asleep while using this product.
- Do not use this product if you are drunk or feel unwell.
- Do not use this product within one hour after a meal.
- Do not use this product with excessive force to avoid any injury.
- Do not carry any fragile, explosive, or combustible material in your pocket, such as a mobile phone and lighter when using the massage chair.

### 2. Operating Environment

- Do not use this product in a very moist environment such as the bathroom.
- Stop using this product immediately when the ambient temperature changes sharply.
- Do not use this product in any heavily-dusty or caustic environment.
- Do not use this product in a small space or a place without good ventilation.
- The normal room temperature ranges from 0 °C to 35 °C.
- Do not use this product in an excessively humid room such as a bathroom. Use it at a relative humidity between 20% and 80%.
- Do not use this product outdoors.
- Avoid direct sunlight.
- Keep this product away from any heat source such as a stove and air outlet of an air conditioner.
- Do not use this product during thunder or lightning weather.
- Do not use this product in dusty places.

### 3. The following populations should not use this product:

- Patients with osteoporosis.
- Patients with heart disease or wearing electronic medical devices such as a pacemaker.
- People who have a fever.
- Pregnant women or women on their menstrual period.
- Patients who are injured or have a skin disease.
- When unsupervised, any children are under the age of 14 and those unconscious are not allowed to use this product.
- People who are told by their physicians to have rest or who feel unwell.
- People whose bodies are wet are forbidden to use this product.
- This product has a hot surface. Persons insensitive to heat must pay attention when using this product.

## Safety and Maintenance

---

### 4. Safety Precautions

- Check whether voltage is consistent with the specification of this product.
- Never insert or pull out the plug with a wet hand.
- Do not let water flow into this product to avoid electric shock or cause damage to this product.
- Do not pull the power cord when plugging or unplugging it. Rough handling is forbidden.
- Do not damage the wire or modify the circuit of this product.
- Do not clean live parts of this product with a wet cloth such as a power switch and plug.
- Be away from this product in case of power failure to avoid any injury if power is restored suddenly.
- Stop using this product at once while it works abnormal, and consult your local supplier.
- Stop using this product if you feel unwell, and consult your health care practitioner.
- This product is not intended for use by persons (including children) with reduced physical, sensory or mental capabilities, or lack of experience and knowledge, unless they have been given supervision or instruction concerning the use of this product by the personnel responsible for their safety. Children should be supervised to ensure that they do not play with this product.
- If the power cord is damaged, it must be replaced by the manufacturer, its service agent or similarly qualified staff in order to avoid hazards.

### 5. Product Service and Maintenance

- This product should be maintained by the service center designated by the manufacturer only. No user should disassemble or maintain it without permission.
- Do not forget to turn off the main power switch after usage.
- Do not use this product if the power socket becomes loose.
- If this product will be left unused for a long period of time, it is necessary to roll up the power cord of this product and store this product in a dry and dust-free environment.
- Do not store this product at a high temperature or near open flame. Avoid prolonged exposure to direct sunshine.
- Please clean this product with dry cloth. Never use thinner, benzene or alcohol.
- The mechanical components of this product are specially designed and manufactured, so no special maintenance is needed.
- Do not use a sharp object to stab at this product.
- Do not roll or pull this product on any uneven ground. Instead, it should be lifted before moving.
- Please use this product intermittently. Do not keep it working continuously for a long period of time.

### 6. Solutions to Ordinary Malfunctions

- If the motor sounds during operation of this product, this is the normal operation sound.
- If the controller cannot work normally, check whether the plug and the power socket are connected reliably, and whether the power switch is turned on.
- If the rated working time is over, this product will automatically activate the power-off button; If this product keeps operating for a long period of time, the temperature protector will stop this product automatically. The product can be used again after half an hour.

### 7. Storage Conditions

- Storage room temperature: -5 °C to 35 °C.
- Relative humidity (RH) between 20% and 80%; free of corrosive gases, and a well-ventilated room.

## Safety Warning

### ⚠ Warning

When the legrest of the massage chair is lifted, nobody should apply pressure on the legrest to prevent the massage chair from falling forward which will damage this product or result in personal injuries.

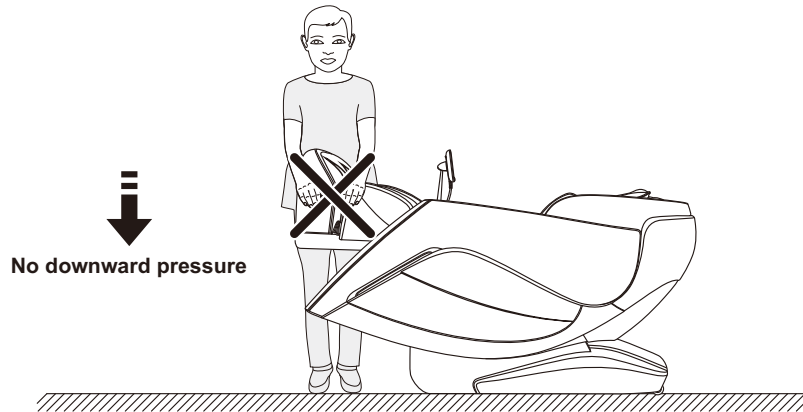

### ⚠ Warning

Before sitting on the massage chair, make sure that the massage chair manipulator does not stay in the seat cushion position to avoid discomfort to the buttocks during the body pressing down and any damage to the massage chair manipulator.

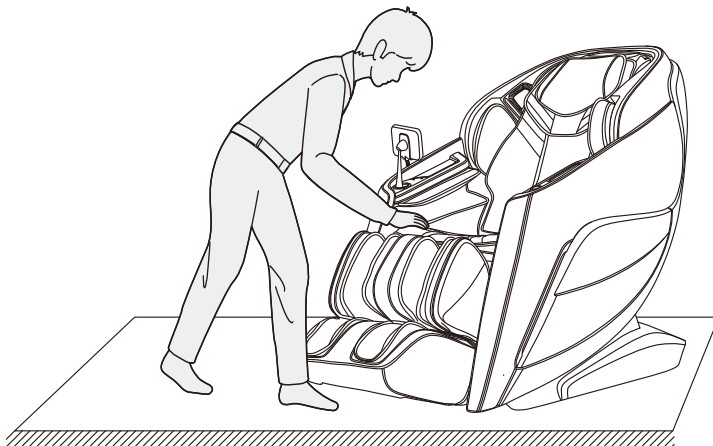

04

## Safety Warning

### ⚠ Warning

Do not remove or pull out the remote controller cable or the power cord in the standby or power-on state to avoid any damage to this product or accidental electric shock of a body part. You are advised to unplug the remote controller cable and the power cord and put them away after you use the massage chair.

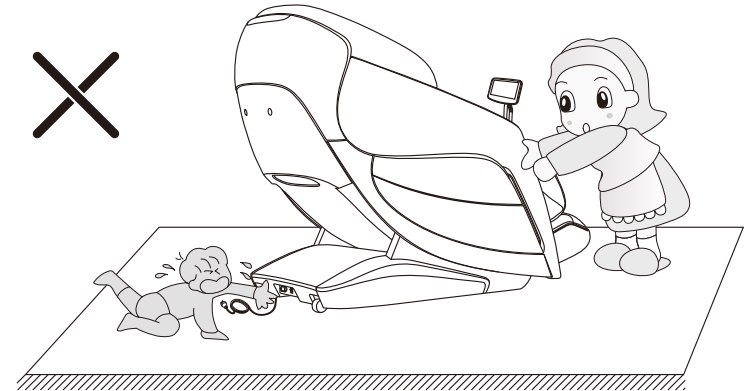

### ⚠ Warning

When the zero-gravity lying function is enabled, be sure to check whether there is any child or pet staying or playing under the bottom of the legrest and backrest, in order to avoid any damage to this product or physical injury.

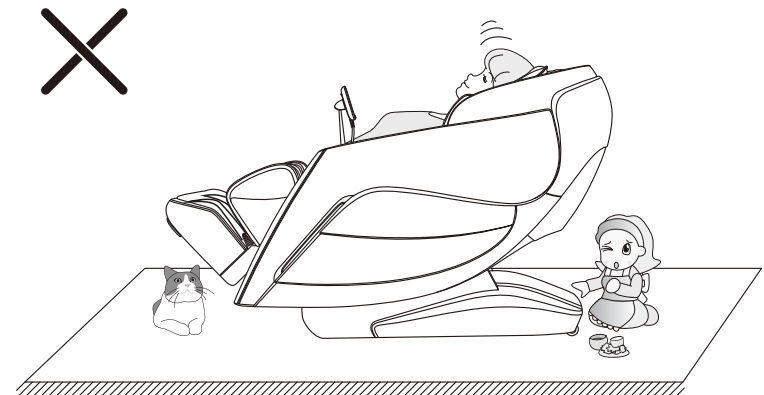

05

## Safety Warning

### ⚠ Warning

Before using the massage chair, remove any hard objects in your pocket(s) or any jewelry carried with you (e.g. key, watch, other similar portable hard objects) to avoid any damage to this product or physical injury during massage.

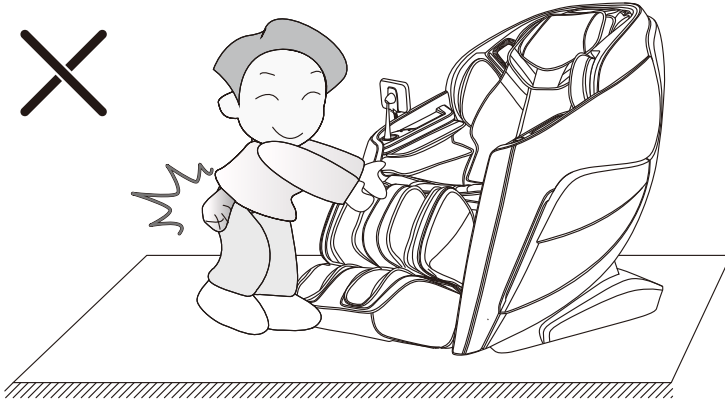

### ⚠ Warning

Do not unplug the power cord, or directly turn off the power switch on the back of the massage chair during massage, in order to avoid any damage to this product or physical injury.

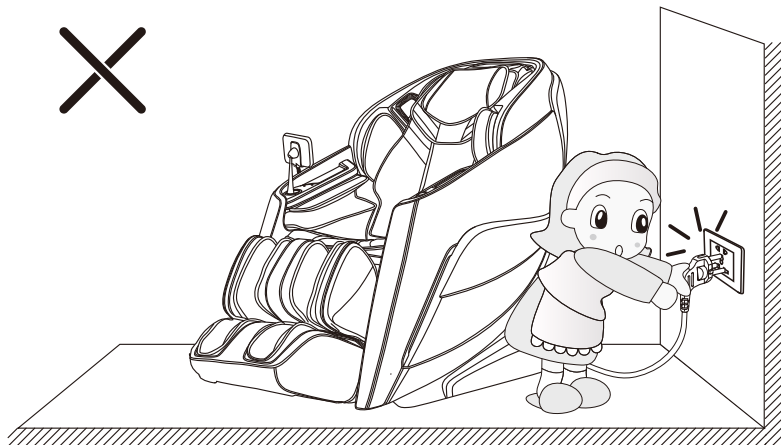

## Safety Warning

### ⚠ Warning

Please do not fall asleep on the massage chair while using to avoid personal injury caused by unconscious use.

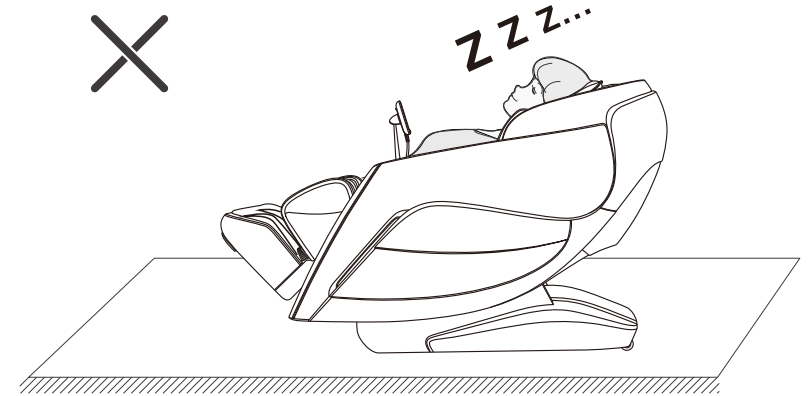

### ⚠ Warning

The massage chair should not be used by more than two people at the same time to avoid product failure or personal injury. In addition, do not let children play on the massage chair or climb onto the lower leg, seat cushion, foot, backrest or armrest. Otherwise, accidents or injuries may be caused.

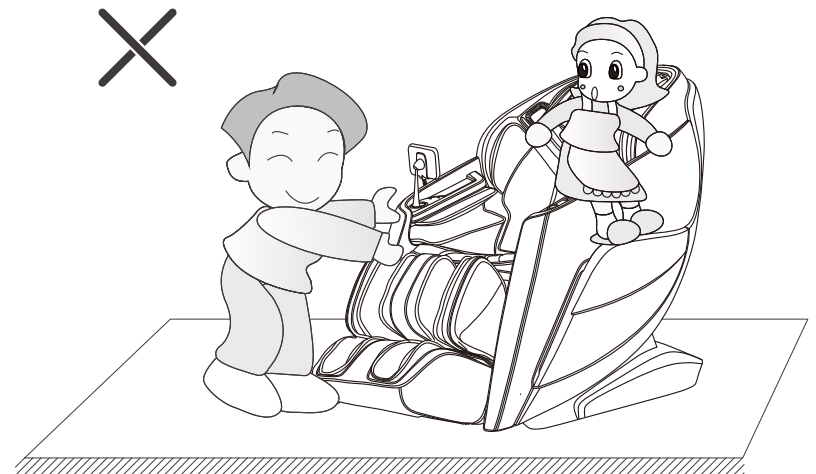

## Safety Warning

### Warning

When adjusting the footrest retractable function or when footrest is declining, please be sure not to put hard objects (such as keys, mobile phones, Etc.) or put the hand into the gap of the footrest, and the intersection with the armrest; To avoid product damage or personal injury caused during the process.

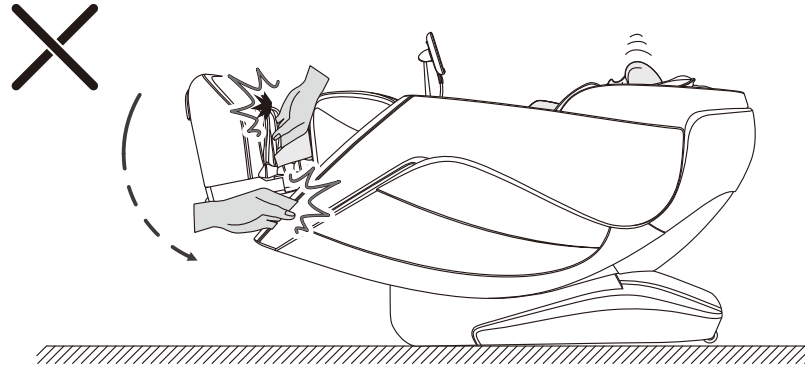

### Warning

Before turning on the massage chair, check the surroundings to make sure that there are no people, pets or other objects around the massage chair. Avoid damage to the product or other objects or personal injury during the operation of the massage.

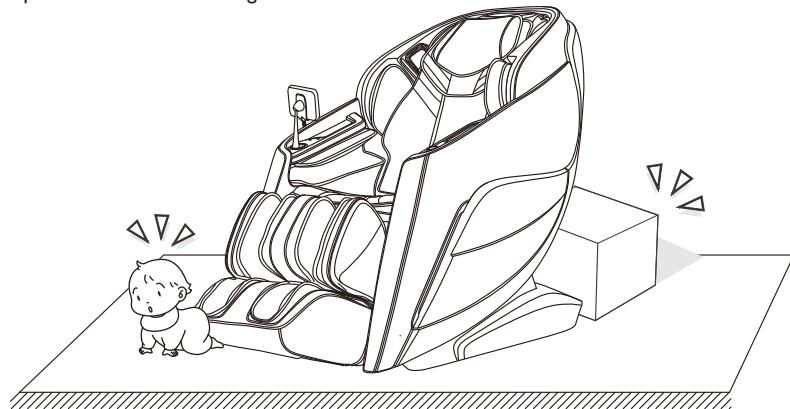

## Name of Components

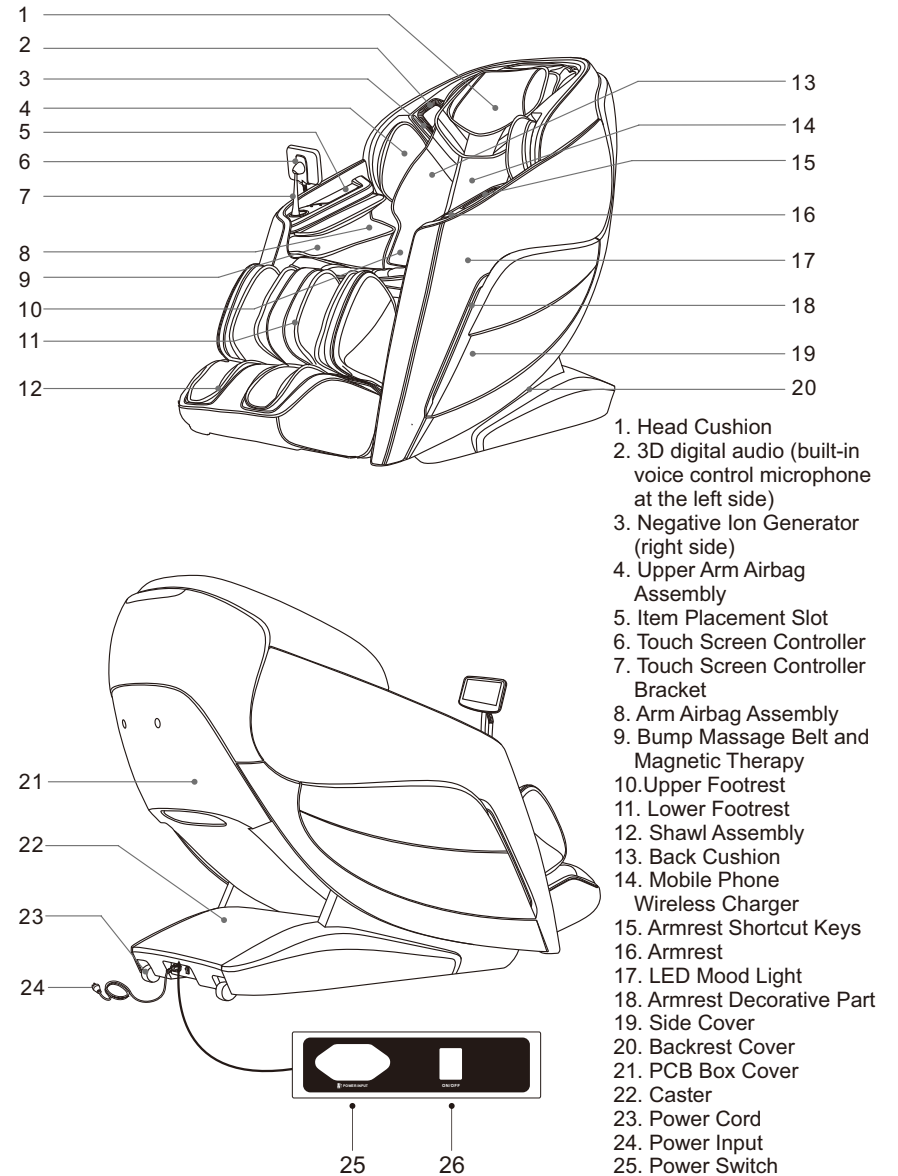

## Function

---

- This product has designed a group of AI massage robots that can walk up and down, stretch back and forth, and are silent in design.
- It is designed with the function of automatic detection and micro-adjustment of shoulder position and the automatic detection function of human body curve and Shiatsu point to automatically adjust the stretch back and forth of the robot according to the detected human body curve and Shiatsu point, making massage more humanized and scientific.
- There are four types of automatic massage scenes with different characteristics: AI intelligent programs (Stress Relieving, Energy, Good-night Sleep, Joint Care, Neck&shoulder care, Spine Massage), exclusive programs for the wise (Only for White-collars, Exercise Conditioning, Relaxing Brain, Spine Care, Waist Care, Legs Care), relaxing and activating programs (Healthy Charge, Meridian Treatment, Keep Fit, Detox, Restoration Massage, Balance) and overall relaxation programs (Full-body Stretch, Thai Massage, Chinese Massage, Total Relax, Psychic Communion), 23 types of automatic massage programs.
- It has three intelligent storage functions: Custom 1, Custom 2 and Custom 3.
- It is provided with five message positions for manual selection, i.e. Full, Partial, Spot, Upper and Lower.
- It is provided with manual massage functions: including 17 massage techniques such as Knead (7 modes for switching cyclically), Tap (Tap I, Tap II), Knead & Tap, Shiatsu (Shiatsu I, Shiatsu II), Grasp, 4D (4D I, 4D II, 4D III, 4D IV) for selection.
- It is provided with massage adjustment functions: including 7 massage adjustment functions such as five-level back speed adjustment, five-level massage scope adjustment, five-level massage width adjustment, pneumatic three-level intensity adjustment, three-level roller speed adjustment and four-level massage time adjustment.
- It is provided with pneumatic massage function: the arm pneumatic massage function (8 built-in airbags), upper arm pneumatic massage function (4 built-in airbags), three-level pneumatic intensity adjustment.
- It is provided with the lower body pneumatic massage function; the leg pneumatic massage function (4 built-in airbags), foot pneumatic massage function (16 built-in airbags), three-level pneumatic intensity adjustment.
- It is provided with a unique shawl assembly, with innovative heating functions on the shoulder, back, waist and abdomen and heating with graphene. Users can place the shawl at different massage positions according to massage requirements. When the shawl assembly is placed at the shoulder position, it will heat the acupoints such as Bingfeng, Tianzong, Yunmen and Qihu around the shoulders and clavicle by graphene heating, effectively relieving symptoms such as scapulohumeral periarthritis and coughs and removing cold and moisture from shoulder joints; when the shawl assembly is placed on the abdomen and back (dual-purpose), through graphene heating, it plays the role of dispelling cold and relieving pain, warming channels and removing blood stasis in the back and abdomen, distributing Qi and blood of the back and abdomen meridian, alleviating the symptoms such as irregular menstruation and dysmenorrhea for women, relieving low back pain and kidney discomfort, warming intestines and stomach and clearing intestinal cold, with a good effect on some people with deficiency of qi and deficiency of spleen and stomach.
- Slide rail technology is adopted for lying down of the backrest frame to always make the backrest zero distance from the wall thus saving space to the greatest extent.

## Function

---

- The guide rail of the backrest frame adopts curved guide rail technology, which completely conforms to the back of the human body and makes people enjoy a massage from the head to the thigh.
- It is provided with an intelligent voice control recognition function to control the massage chair with voice.
- Music playing system, with built-in 3D digital audio in the left and right upper arms. The Bluetooth function of intelligent devices can be used for wireless connection to play music.
- Mobile phone wireless charging function is set at the shortcut key of the left armrest and the mobile phone is placed in a fixed wireless charging position for charging.
- The left armrest is provided with shortcut keys such as On/Off (Pause) key, 4D intensity knob key, zero-gravity key, automatic mode key, voice control wake-up key, foot rest telescopic key, leg rest telescopic key, seat-up key, seat-down key, etc.
- It is provided with adjustment functions between calf-up and calf-down, between seat-up and seat-down, between zero-gravity 1 and zero-gravity 2.
- It is provided with calf kneading function: kneading and airbag squeezing around the inside and outside of the calves, which can relieve the stiffness or tension of the calf muscles caused by long standing.
- It is provided with foot roller massage function to scrape and massage mastoid at the arch and toes.
- It is provided with ankle stretching function: use the airbag squeezing function of foot rest and leg rest to fix the calf and feet by airbag tension, and then stretch the ankle by stretching the foot rest up and down, effectively alleviating muscle stiffness, leg muscle soreness and ankle strain after long-term walking and strenuous exercise.
- It is provided with leg traction massage function: the calf and backrest are lifted to form automatic lying down in a cyclic manner. At the same time, the lower leg air compression and the back manipulators cooperate together to massage, and the legs can be stretched for traction massage.
- The foot rest has the function of automatically detecting the plantar position. When the calf frame rises or falls to a proper angle, the foot rest will automatically detect the plantar position.
- The foot rest is provided with an electric telescopic adjustment function, which can adjust the telescopic distance according to the leg length of the user to achieve the most comfortable massage position and length for the foot.
- It is provided with a bump massage belt and magnetic therapy function in the left and right palm airbags.
- The left space capsule is provided with a voice control microphone and the right side of the head is provided with a negative oxygen ion generator.
- It is provided with a 7-inch TFT colored touch screen controller.
- It is provided with LED mood lights at the left and right armrest.
- Automatic sit-up function when the power is off and manipulator automatic reset function.



## Touch screen manual controller interface introduction

### Touch screen remote controller introduction



**Note: The touch screen remote controller displays the color, massage function and message function icon layout order, please refer to the physical display!**

1. Bluetooth switch and display
2. Time adjustment button and display
3. The status bar
4. The shoulder position can be adjusted up and down
5. Massage status information display
6. Air pressure intensity display
7. Manual, intelligent storage, angle adjustment, settings and other massage function keys
8. The power switch
9. Automatic massage function
10. Massage switch
11. 4D massage function keys
12. Operation / pause button

## Method of Usage

### I. Switch power supply on

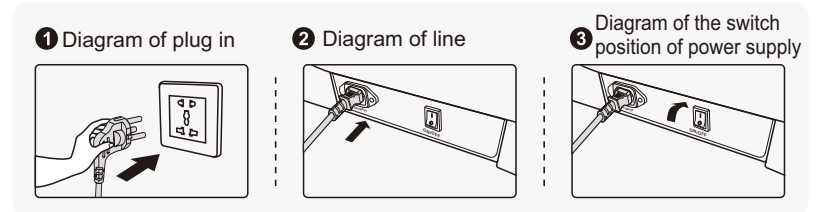

### II. Massage function control operation

#### 1). Start to massage

- After the massage chair cannot enter any mode operation in standby mode.
- Press "Power" button to start massage, enter the boot screen, backrest maintains the default position, calf rest raises slightly, choosing certain auto mode to start massage (Auto mode or memory function can be selected). The massage chair will shut down automatically if auto mode is not selected within 5 minutes.

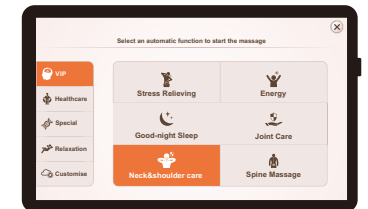

- VIP Auto Program: Stress Relieving, Energetic Morning, Good-night Sleep, Joint Care, Neck&shoulder care, Spine Massage.
- Healthcare Auto Program: Office Regimen, Sport Recovery, Brain Refresh, Spine Care, Waist Care, Legs Care.
- Special Auto Program: Health Recharge, Meridian Treatment, Keep Fit, Bottom Toning, Restoration Massage, Tiredness Relief.
- Relaxation Auto Program: Full-body Stretch, Thai Massage, Chinese Massage, Total Relax, Airbag.



## Method of usage

- When you select any of the automatic modes, the backrest and calf position will be adjusted to the set angle.
- After adjusting the angle, the massage chair will automatically proceed detection of your shoulder position and acupressure points (Note: There is only shoulder position detection when in Frozen Shoulder program, while the others are whole body detection.). If the scan uncompleted, you press the “✕” button to skip the detection, automatically operate the default massage mode.

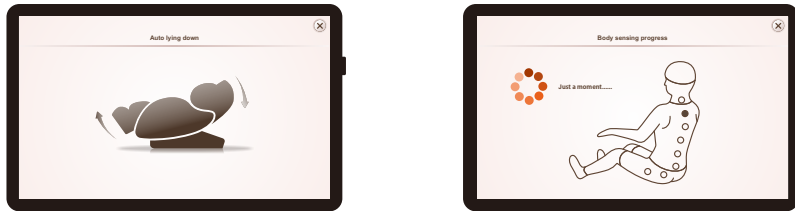

- Upon completion of scan, a beeping sound will emitting from the chair for 10 seconds or press the enter button, the massage heads will gently roll on your shoulders. During this period, if you would like to further adjust the detected shoulder region, you can do so by depressing the up or down shoulder button. There are 11 levels adjust position. If fail to detect, automatically operate the default massage point.

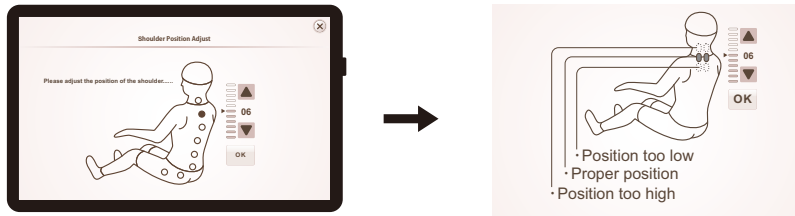

Buttons	Description
	Press to adjust the massage heads higher.
	Press to adjust the massage heads lower.

## Method of usage

### 2). The pause button

- While the massage function is operate, press the “Pause” button to temporarily stop all massage functions; Press the “Pause” button again to continue the massage. If the pause time exceeds 20 minutes, all massage functions are automatically turned off.

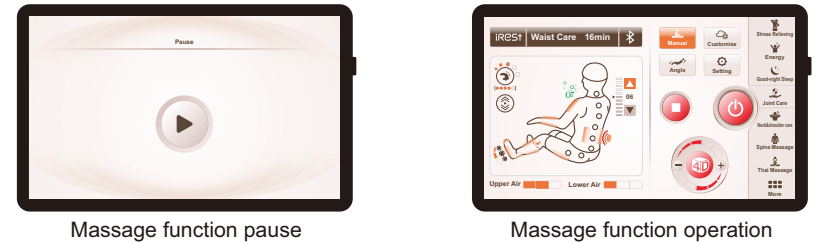

Massage function pause

Massage function operation

Run/pause Button	Functional description
Pause	In the operation state, press this button to pause all current massage functions.
Operation	In the pause state, press this button to continue the massage function before the pause

### 3). Upper body massage strength (4D key)

- Under the massage information interface, click the “-” or “+” button on the 3D icon to adjust the massage intensity of the upper back muscles, Five levels intensity.



#### Note:

- Massage strength: 4D massage strength, that is, the massage head is extended forward or the whole is retracted. The strength of the massage is adjusted to the strength within a certain massage area. Detect acupressure points, the strength of each massage point can be tested. You can adjust the strength of a certain massage point with this button in both automatic and manual conditions.

## Method of usage

### 4). Automatic function

- There are four different automatic massage scenes in Auto mode:
- VIP Auto Program: Stress Relieving, Energetic Morning, Good-night Sleep, Joint Care, Neck&shoulder care, Spine Massage.
- Healthcare Auto Program: Office Regimen, Sport Recovery, Brain Refresh, Spine Care, Waist Care, Legs Care.
- Special Auto Program: Health Recharge, Meridian Treatment, Keep Fit, Bottom Toning, Restoration Massage, Tiredness Relief.
- Relaxation Auto Program: Full-body Stretch, Thai Massage, Chinese Massage, Total Relax, Airbag. There are 23 automatic massage functions in total. Click the "auto" icon to select the automatic massage, when in automatic massage, the speed and width can not be adjusted.
- Press "more" icon to select the corresponding automatic massage function.



Auto mode	Function	Description
VIP	Stress Relieving	Relieve fatigue and relax muscle, improve microcirculation of back & limbs and quickly relieve stress.
	Energy	The body gets rest after one night sleeping. Quickly wakeup all the body functions by massaging whole muscle to start a fresh day.
	Good-night Sleep	It helps balance your body, quickly improve sleep quality by massaging the 12 health acupoints.
	Joint Care	Care for the health of all joints by pushing, pulling, stretching and other massage modes
	Neck& shoulder care	The unique massage mode for neck and shoulder, relieve neck and shoulder pain and improve blood supply in the brain.
	Spine Massage	Massage each spine to protect its health, alleviate slipped disc.

## Method of usage

Healthcare	Office Regimen	Increase physical exercise by massage, improve the body functions of Office Sedentary.
	Sport Recovery	Restoring physical fatigue quickly of after-exercise-body.
	Brain Refresh	Relieve neck and shoulder pain, promote blood supply to the brain by massaging YUZHEN and DAZHU points.
	Spine Care	Care for the health of spine and improve the lack of exercise.
	Waist Care	Focus on improving spine health and relieving stiffness in the waist muscles.
	Legs Care	Quickly relieve the soreness and muscle fatigue in lower body.
Special	Health Recharge	Improve the quality of nap and work efficiency.
	Meridian Treatment	Dredge the meridians, improve the body's microcirculation and immunity quickly.
	Keep Fit	Effectively massage buttocks and legs to shaping the body, reduce the accumulation of body fat.
	Bottom Toning	Improve overall blood circulation of body to enhance vitality and immunity.
	Restoration Massage	Wake up all body functions quickly, replenish physical strength and restore fatigue by massaging the 12 health acupoints.
Relaxation	Tiredness Relief	Relieve fatigue, restore vitality, clean the blood lactic acid produced after exercise.
	Full-body Stretch	Stretch the body to increasing its flexibility by Thai massage.
	Thai Massage	Comprehensively relieve fatigue and soreness through a deep massage for whole body.
	Chinese Massage	According to the traditional Chinese medicine theory, balance the body function to achieve physical fitness and remove the disease.
	Total Relax	Total Relax, soothing massage the whole body by kneading and tapping to relieve fatigue.
	Airbag	Focusing on body pressure massage, it can fully relax the body, restore fatigue, and calm the nerves.

## Method of usage

### 5). Manual

- Click the "Manual" icon to enter the manual massage function selection interface, including manual, manual strength and width, back stretch, upper airbag massage, lower air bag massage, calf squeeze, foot rollers, Negative oxygen ions, heat and other massage functions.
- Click the "X" icon to close the manual massage interface.

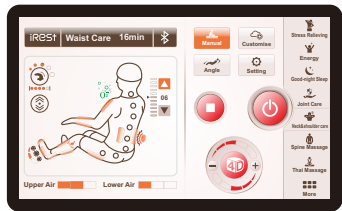

Manual massage function selected interface

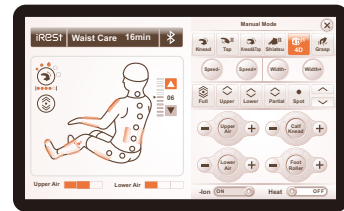

Manual massage function interface

### 01). Manual - manipulation

- Under the manual massage function interface, select the manual massage technique, back stretch, speed and width adjustment.
- Manual (manipulation): includes six different massage techniques: knead, tap, knead & tap, shiatsu, 4D, and shoulder. In the state of tap and shiatsu massage, the width of the massage ball of the robot is adjustable. The massage speed can be adjusted in other massage techniques except for stopping. You can also close the manual massage interface by clicking the "X" icon.

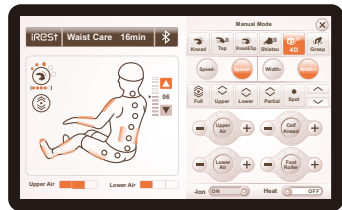

Manual massage function - manual interface

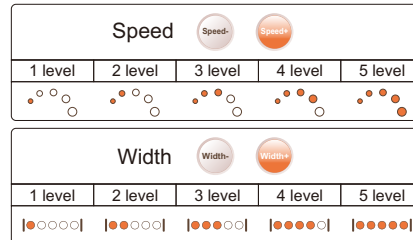

## Method of usage

Function	Description	
Kneading(Seven modes of kneading can be switched cyclically)	Speed, Intensity	
Tapping(Tapping I, Tapping II)	Speed, Width, Intensity	• 5 Speed levels adjustable
Simultaneous kneading and tapping	Speed, Intensity	• 5 Width levels adjustable
Shiatsu(Shiatsu I, Shiatsu II)	Speed, Width, Intensity	• 5 Intensity levels adjustable
Shoulder lifting	Speed, Intensity	
4D(4D I, 4D II, 4D III, 4D IV)	Speed, Width, Intensity	

Note: In 4D massage technique mode, the width of 4D I and 4D II cannot be adjusted; the width of 4D III and 4D IV can be adjusted.

### 02). Manual - back stretching

- Manual (massage area): includes massage functions such as fixed, partial, overall, upper back, and lower back.
- Click on the corresponding stretch mode icon to select the personalized massage function. You can also close the manual massage interface by clicking the "X" icon.

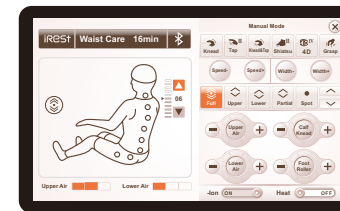

Manual massage function - back stretching interface

## Method of usage

Function	Description
Point	Press button once, a single dot appears in the display. Massage apparatus will stay stationary.
Local	Press button again, two arrows appear. Massage apparatus will move in an approximately 3 inch range.
Upper back	Round back massage.
Lower back	Round back massage.
overall	Full back massage.
Upper adjust	Press and hold to move the range of the massage area up in the Fixed or Partial Position.
Lower adjust	Press and hold to move the range of the massage area up in the Fixed or Partial Position.

### 03)、Manual - air pressure massage

- Manual (air pressure): includes upper body airbag pressure and lower body air pressure massage function. Click the air pressure function icon to turn the air pressure massage function on or off. Adjust the intensity by clicking the "−" or "+" button. You can also close the manual massage interface by clicking the "×" icon.

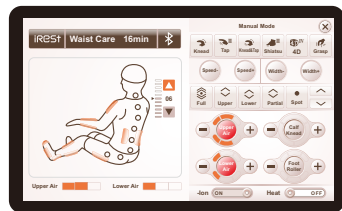

Manual massage function - air pressure selection interface

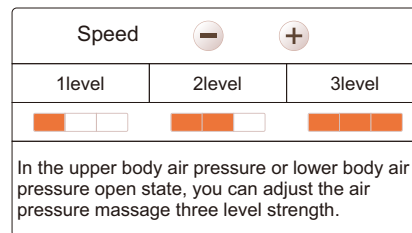

In the upper body air pressure or lower body air pressure open state, you can adjust the air pressure massage three level strength.

Function	Description
Upper Air	Turn the upper body air pressure massage function on or off.
Lower Air	Turns the lower body air pressure massage function on or off.

## Method of usage

### 04)、Manual - calf squeeze

- Select to turn the calf massage function on or off by pressing the "Calf Knead" button; There are three different calf massage modes. Adjust the calf massage mode by clicking the "−" or "+" button.
- Click the "×" icon to close the manual massage interface.

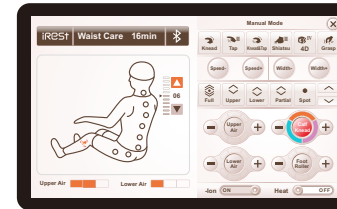

Manual massage function – the calf squeeze interface

Calf squeeze massage mode		
Mode I	Mode II	Mode III
Forward	Reverse	Positive inversion
After opening calf squeeze massage function, adjust positive and negative rotation massage function.		

Function	Description
	Press the switch on or off the calf squeeze massage function.

### 05)、Manual - foot rollers

- By Pressing "Foot Roller" to select switch on or off the foot rollers massage function. Click "−" or "+" to adjust the speed of the roller. The speed can be adjusted in three levels. You can also click "×" icon to close the manual massage interface.

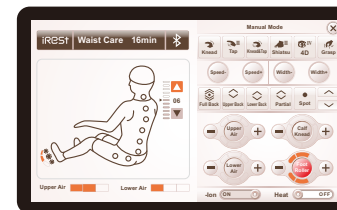

Manual massage function - foot rollers selection interface

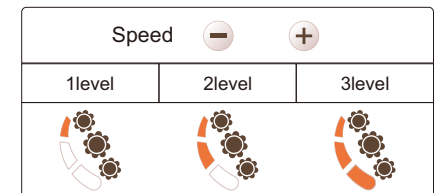

Function	Description
	Press the switch on or off the foot rollers massage function.

## Method of usage

### 06). Manual - negative oxygen ion

- Click the “Negative Ions **ON**” button to select switch on or off the negative oxygen ion message function. You can also click the “✕” icon to close the manual message interface.

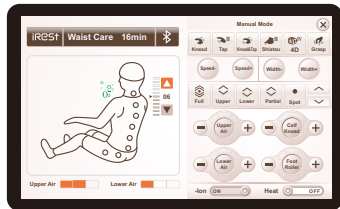

Manual message function - Negative Ions selection interface

Function	Description
 Negative oxygen ion	Press this button switch on or off the negative oxygen ion function.

### 07). Manual - back heating

- Click the “Heat **ON**” button to turn on or off the heating function of the cape (graphene heating) . it will be warm 3 minutes after the heating function is turned on
- Click the “✕” icon to close the manual message interface.

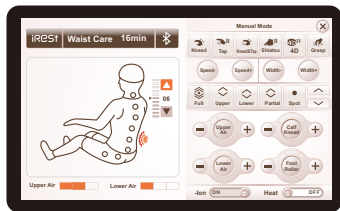

Manual message function - heating selection interface

Function	Description
 Heat	Press this button to turn on or off the heating function.

## Method of usage

### 6). Customise

- Click the “**Customise**” button icon to enter the program memory message function selection interface, including program memory I, program memory II, program memory III and other storage or recall functions.
- Select to the storage or recall message function by clicking on it.
- Storage: Store all current massage methods, air pressure, angle, and other massage functions.
- Call: Call the previously stored technique, air pressure, angle, and other massage functions.
- Click the “✕” icon to close the program memory message interface.

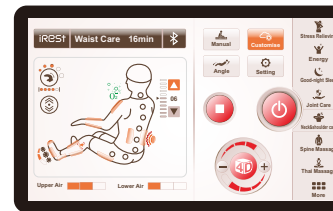

Program memory selection interface



Program memory interface

### 7). Angular adjustment

- Click the “**Angle**” button icon to enter adjustment interface, including massage function of linkage sitting, linkage lying, calf rise, leg down, zero gravity, leg stretch, and foot stretch.
- Click the “✕” icon to close the angle adjustment interface.

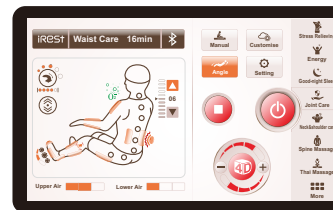

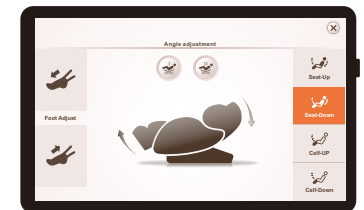

Angle adjustment selected interface







Angle adjustment interface

## Method of usage



### 01). Zero gravity adjustment

Function	Description
	Zero gravity I : Automatically adjust the calf and backrest position to zero gravity I position.
	Zero gravity II : Automatically adjust the calf and backrest position to zero gravity II position.

### 02. Lying angle adjustment



Function	Description
 Calf-Up	Leg up key: Press and hold to raise the calf unit independently of the backrest, release to stop; After the calf rest up is completed, the calf frame will automatically detect the length of the foot.
 Calf-Down	Leg down key: Press and hold to lower the calf unit independently of the backrest, release to stop; After the calf rest down is completed, the calf frame will automatically detect the length of the foot.
 Seat-up	Seat-up key: press and hold this key to slowly rise the backrest frame while slowly lowering the calf frame, and release it to stop rising of the backrest frame or lowering of the calf frame; after the seat-up action is completed, the calf frame will automatically detect the foot length.
 Seat-down	Seat-down key: press and hold this key to slowly lower the backrest frame while slowly rising the calf frame, and release it to stop lowering of the backrest frame or rising of the calf frame; after the seat-down action is completed, the calf frame will automatically detect the foot length.

### 03). Footrest Stretch adjust

Function	Description
	Foot rest shortening key: manually adjust shortening of the foot rest; press and hold this key to move the foot rest up slowly and stop when released.
	Foot rest extension key: manually adjust extension of the foot rest; press and hold this key to move the foot rest down slowly and stop when released.

## Method of usage

### 8). Settings

- Click the “” button icon to enter the setting selection interface, including backlight brightness adjustment, sleep time adjustment, button volume switch, serial number, language selection and other settings.
- Click the “” icon to close the settings interface.



Setting selection interface

Setting interface

#### 01). Brightness

- Select brightness slider and slide left and right to adjust the backlight brightness.

#### 02). Auto-Lock

- Select lock screen button and make choice with 1 minute, 3 minutes, 10 minutes or 30 minutes.

#### 03). Sound

- Click the “” icon to turn off the button volume, and click “” to turn on the button volume.

#### 04). Language



- Language selection

#### 05). S/N

- Displays information such as current equipment.

## Method of usage

### 9). Bluetooth

- Click the “” icon to switch on or off Blue tooth. “” is to switch off the Blue tooth status, and “” is to switch on the Blue tooth status.
- After the Blue tooth-enabled audio source device (such as mobile phone, MID tablet, etc.) is paired with the massage chair Blue tooth module, the music played by the audio source device can be wirelessly transmitted to the massage chair audio system for music playback via Blue tooth.

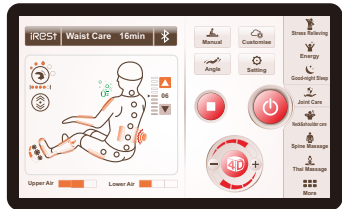

Blue tooth interface not enabled

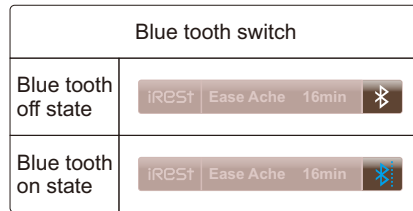

Attentions: When controlling the Blue tooth switch, you should return to the main information control interface. If you are in the manual, angle adjustment or custom storage control interface, Blue tooth can't be controlled.

### 10). Time adjustment

- Click the “16min” icon to adjust the massage time function. Each time you press it, it will add 5 minutes. It cannot exceed 40 minutes. If it exceeds 40 minutes, it will return to 5 minutes.

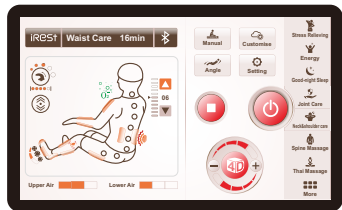

Time adjustment interface

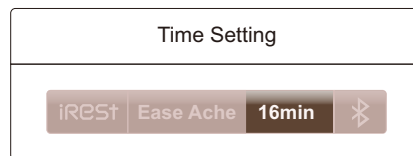

Attentions: When adjusting the time, you should return to the main information control interface. If you are in manual, angle adjustment or custom storage control interface, the time cannot be controlled.

## Method of usage



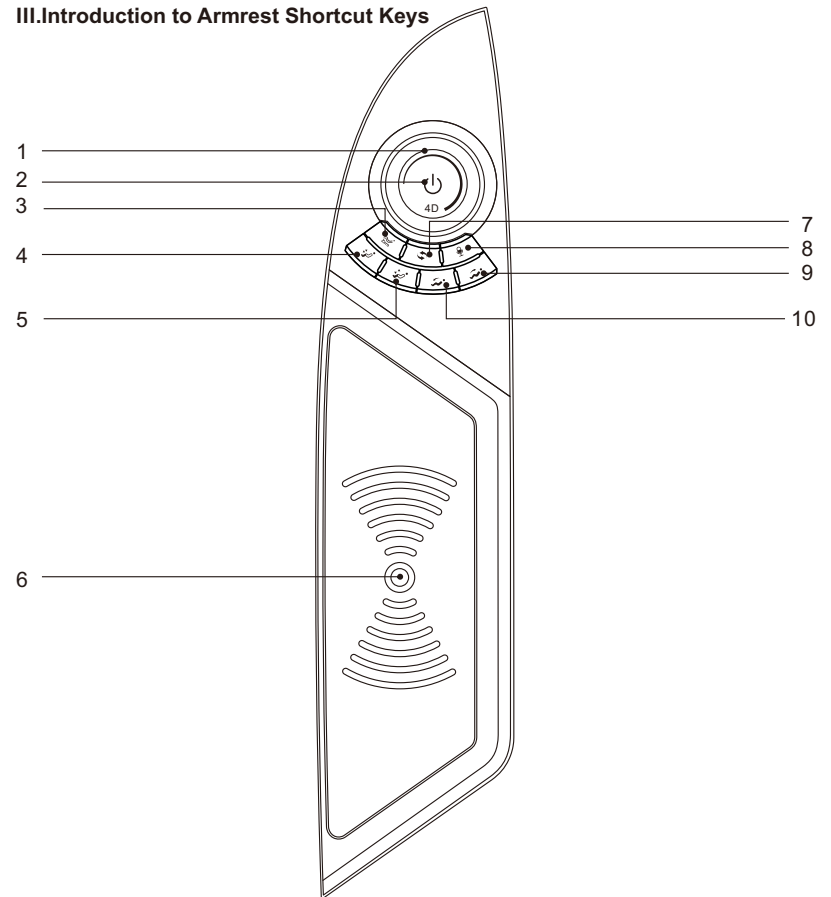





### III.Introduction to Armrest Shortcut Keys



1. 4D Intensity rotation button: adjust the massage intensity of the 4D manipulator.
2. On/Off key: Turn on (short press to pause) or off the massage chair.
3. Zero Gravity key: adjust massage chair to the zero gravity angle.
4. Extension adjustment of the foot rest: extend the foot rest by adjustment.
5. Shortening adjustment of the foot rest: shorten the foot rest by adjustment.
6. Wireless Charging: Mobile Phone Wireless Charger.
7. Auto key: Adjust the automatic massage function, and cyclically switch the automatic function every time you press it.
8. Voice Control Wake-up key: Short press this key to wake up the voice control, long press for 3 seconds to turn on/off the voice control function.
9. Linkage Lying key: adjust the linkage lying angle.
10. Linkage Up key: adjust the linkage up angle.



## Method of usage

Function	Description
	On/Off key: short press this key to suspend operations and press it for 3 seconds to turn it on and off. If the pause lasts for more than 20 minutes during massage, all massage functions will be automatically turned off.
	4D intensity knob key: Adjust the massage intensity of 4D manipulator (weakened when rotating counterclockwise, enhanced when rotating clockwise), and the intensity ranges from Level 1 to Level 5.
	Zero-gravity key: each time the key is pressed, the position of the calf frame and backrest frame will be automatically adjusted to the zero-gravity position. There are two zero-gravity lying modes, which can be switched in cycles.
	Footrest shortening key: manually adjust the Footrest shortening; Press this key to slowly shorten the movement of the Footrest up, release to stop.
	Footrest elongation key: manually adjust the Footrest elongation; Press this key to slowly extend down the Footrest to move, release to stop.
	Auto Mode key: Switch the automatic massage function every time you press it.
	Voice Control Wake-up key: Short press this key to wake up the voice control, long press for 3 seconds to turn on/off this function.
	Seat-up key: Press and hold this key to slowly rise the backrest frame while slowly lowering the calf frame, and release it to stop rising of the backrest frame or lowering of the calf frame; after the seat-up action is completed, the calf frame will automatically detect the foot length.
	Seat-down key: press and hold this key to slowly lower the backrest frame while slowly rising the calf frame, and release it to stop lowering of the backrest frame or rising of the calf frame; after the seat-down action is completed, the calf frame will automatically detect the foot length.

## Method of usage

### IV. Voice Control Mode

- When the massage chair is turned on or in standby mode, the sound "Hi Alice" or "Hey Alice" will be produced to enable the voice control function.
- Long press zero gravity button of remote controller for 3 seconds to turn on or off this function.
- After such function is enabled successfully, the massage chair will reply "I am here". At this moment, once a corresponding voice control entry to be implemented is given within six seconds, the corresponding voice control function can be performed after a reply is received from the massage chair; if no correct voice control entry is given within six seconds, the voice control function automatically will be off automatically and needs to be enabled again.
- Note: When the voice control function is enabled, please use English. The speaking speed cannot be too fast. The speech instruction should be issued according to the voice control entry.

Voice Control Entry		
Entry: "Hi Alice" or "Hey Alice". Answer: I am here.		
No.	Voice control entry	Answer entry
1	Massage on	Answer: Ok, massage on
2	Massage close	Answer: Ok, massage close
3	Comfort Massage	Answer: Ok, comfort massage
4	Relax massage	Answer: Ok, relax massage
5	Full body massage	Answer: Ok, full body massage
6	Neck and shoulder massage	Answer: Ok, neck and shoulder massage
7	Back and waist massage	Answer: Ok, back and waist massage
8	Stretch massage	Answer: Ok, stretch massage
9	Open the air pressure	Answer: Ok, open the air pressure
10	Close the air pressure	Answer: Ok, close the air pressure
11	Up the seat position	Answer: Ok, up the seat position
12	Down the seat position	Answer: Ok, down the seat position
13	Change the other mode	Answer: Ok, change the other mode
14	Go little down	Answer: Ok, go little down
15	Go little up	Answer: Ok, go little up

Note: commands 14 and 15 can only be used after command 13.

## Method of usage

### V. Turn off power, stop massage

- In the process of massage, press the power switch key to immediately turn off all massage functions, the backrest and the calf are reset, the massage time is up, and all massage functions are immediately turned off, and the backrest and the calf are not reset.
- Cut off the power supply of the whole machine, the figure (schematic diagram of the whole machine power cut).

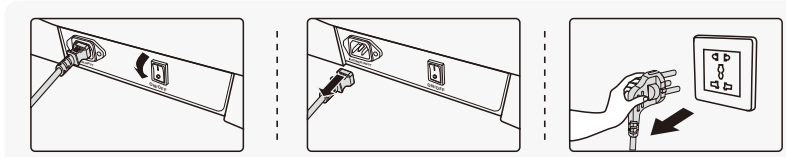

- ① Schematic diagram of the whole machine power turning off.
- ② Schematic diagram of unplugging the whole machine wiring.
- ③ Schematic diagram of unplugging the power plug.

### VI. Installation Instructions for Armrests

1. Find out the connector and air tube from the bottom of the seat frame and pass out from the middle of the seat frame (Figure 1).
2. Take out the armrest from the package and make the connector and air tube on the armrest correspond to the connector and air tube at the bottom of the seat frame one by one (butt joint according to the mark on the physical butt joint line) (Figure 2).

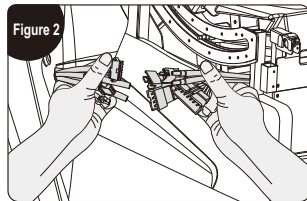
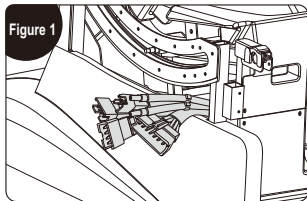

3. The connector and air tube on the armrest are inserted into the connector and air tube at the bottom of the seat frame, which should be in place and firm (Figure 3).
4. After the air tube and connector are docked, insert them into the bottom of the seat frame and take care to avoid the air tube from being folded (Figure 4).

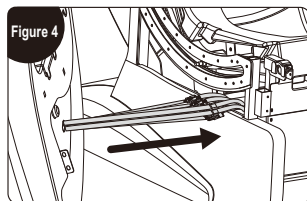
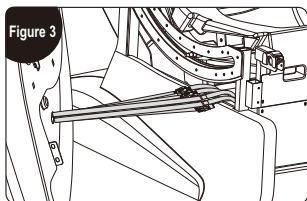

## Method of usage

5. Hold the armrest with both hands, first hook the front end of the armrest, hang it in the seat frame steel and press down the front end of the armrest. (Figure 5)
6. Then, align the male buckle on the rear end of the armrest with the female buckle on the capsule, insert the rear end of the armrest into the female buckle of the capsule and snap it tightly (note that the fit gap of the armrest capsule should be even). (Figure 6)

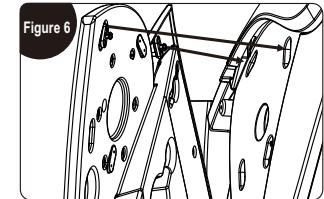
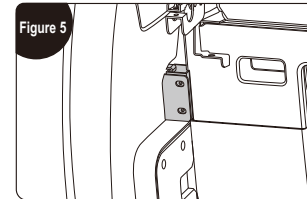

7. Fix the rear end of the armrest tightly with a M6\*20 screw (Figure 7).
8. Pull the upper arm holster away and fix it with a M6\*20 screw (Figure 8);

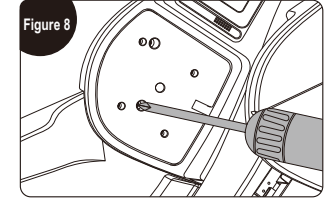
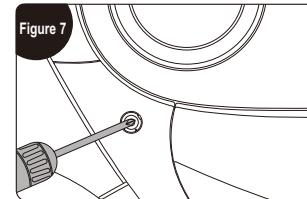

9. Align the mounting holes that fix the steel frame at the front end of the armrest, and then use the provided 4# Allen wrench to fix and tighten the armrest and the seat frame steel piece with two M5×14 black zinc environmental friendly hexagon socket head cap screws and a 6×12×1.5 black zinc environmental friendly flat pad (Figure 9).
10. Install the screw hole plug at the back end of armrest (Figure 10).

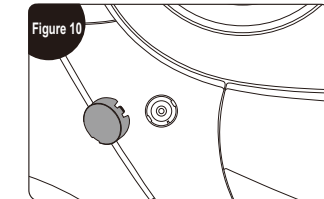
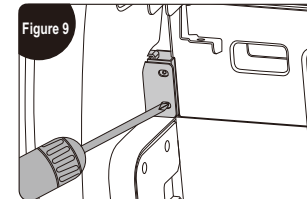

## Method of usage

### VII. Installation Instructions for Legrest

1. First of all, cut the connection wire and the air pipe tie fixed on the steel pipe (Figure 1).
2. Connect the connection wire and the air pipe leading from the lower end of the backrest to the legrest connectors. Confirm whether butt connection is OK. Then insert the butt connection wire and air pipe into the bottom of the frame from the lower hole of the backrest. Pay attention to avoiding any air pipe bending during insertion (Figure 2).

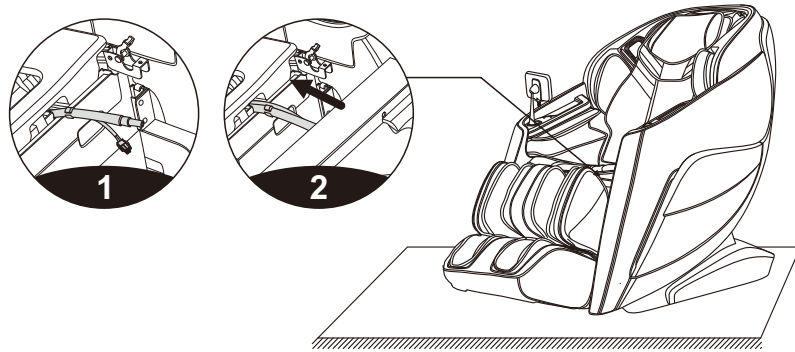

3. Firstly, insert the rotating inner sleeve and the rotating outer sleeve into the left and right rotation shafts of the legrest (Note: The large step must face inward) (Figure 3).
4. Then remove the rotation shaft cover supporting the legrest on the left and right frames of the massage chair (Figure 4).

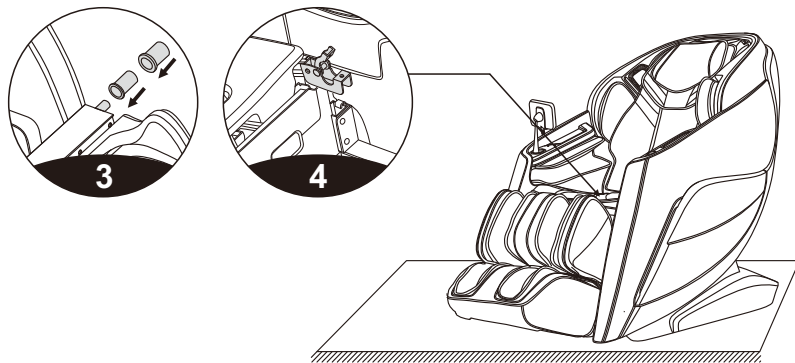

## Method of usage

5. Next, hang the legrest (left and right rotation shafts) into the rotation shaft cover supporting such frames simultaneously (Figure 5).
6. Place the rotation shaft cover. Press the rotating outer sleeve of the legrest. Then tighten the rotation shaft cover supporting the legrest with two M5×14 black zinc environmentally-friendly hexagonal socket head screws and a 6×12×1.5 black zinc environmentally-friendly flat pad by the supplied 4# hex wrench (Figure 6).

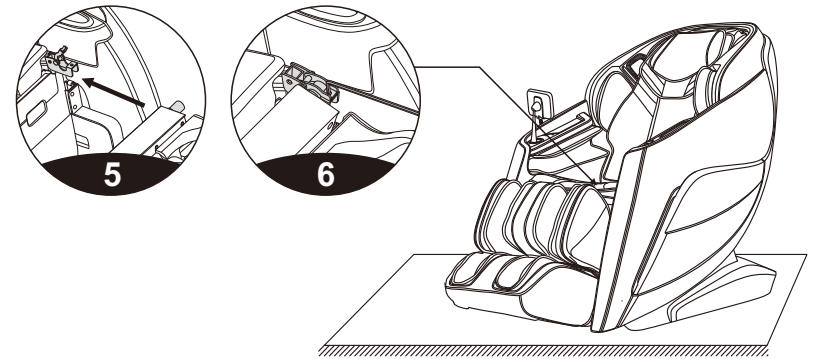

7. After the screws are tightened, hook the groove at the back end of the legrest cover to the hinge pin. Then press down the front end of the legrest cover to make it completely parallel to the rotation shaft cover. Hook the convex point at the side of the legrest cover to the hole at the side of the legrest hook. Finally, the legrest is installed (Figure 7)

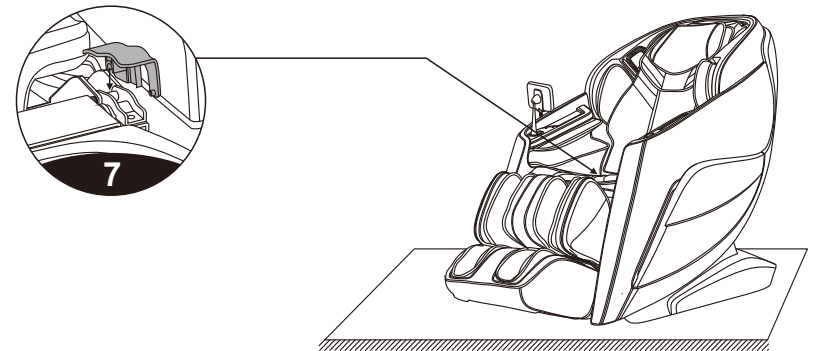

## Method of usage

### VIII. Installation Instructions for Legrest

1. Align the positioning column of the bracket assembly with the positioning hole of the armrest bracket support plate and lock it with 3 cross-recessed screws (Figure 1).
2. Then fasten the decorative cover of the support (Figure 2).

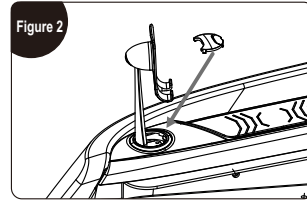
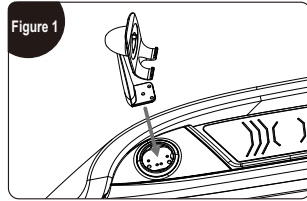

### IX. Use of the shawl

- It is provided with a unique shawl assembly, with innovative heating functions on the shoulder, back, waist and abdomen and heating with graphene. Users can place the shawl at different massage positions according to massage requirements. When the shawl assembly is placed at the shoulder position, it will heat the acupoints such as Bingfeng, Tianzong, Yunmen and Qihu around the shoulder and clavicle by graphene heating, effectively relieving symptoms such as scapulohumeral periarthritis and cough, and removing cold and moisture from shoulder joints.
- When the shawl assembly is placed on the abdomen and back (dual-purpose), through graphene heating, it plays the role of dispelling cold and relieving pain, warming channels and removing blood stasis in the back and abdomen, distributing Qi and blood of the back and abdomen meridian, alleviating the symptoms such as irregular menstruation and dysmenorrhea for women, relieving low back pain and kidney discomfort, warming intestines and stomach and clearing intestinal cold, with a good effect on some people with deficiency of qi and deficiency of spleen and stomach.

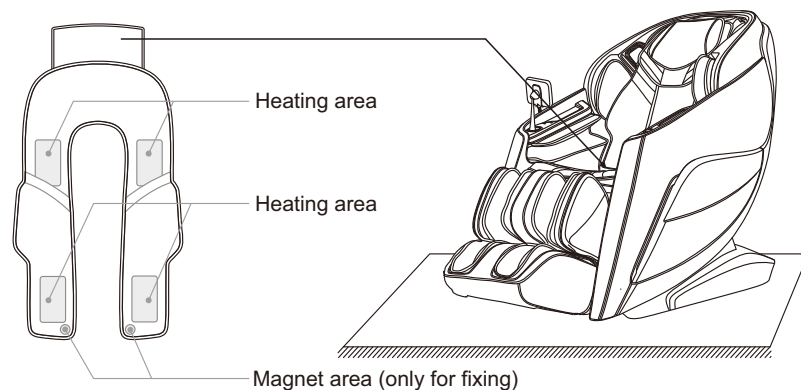

## Method of usage

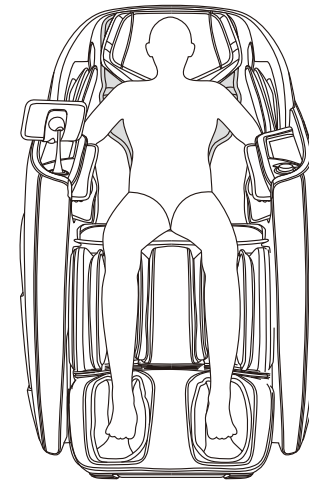

Schematic diagram of back and waist

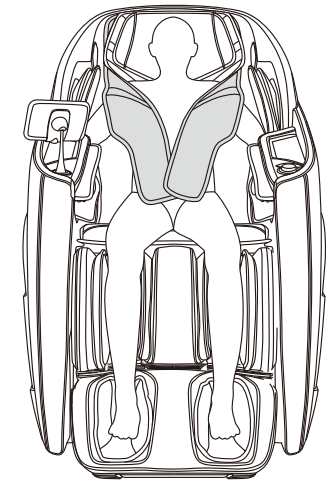

Schematic diagram of shoulder and abdomen

### X. Pillow Pad and backrest pad's dismounting and use manual

- Using head cushions can reduce the kneading massage intensity on neck and shoulder, according to your needs to decide whether the head cushions is needed (recommend head cushions). Backrest cushion and backrest connected by zipper (1), head cushions and backrest pad connected by zipper (2).

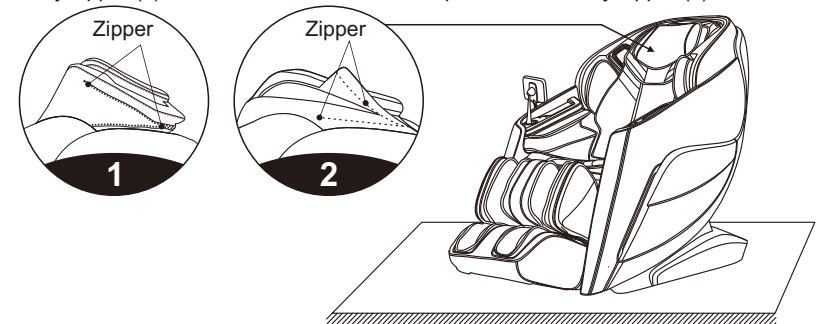

## Method of usage

### XI. Floor Protection

- Put the heavy massage chairs on the wood floor for a may damage the floor, so please place a carpet or other object to avoid this damage.

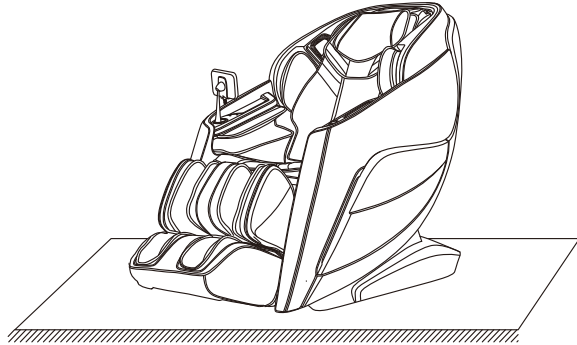

Caution: Do not move the chairs with its wheels on wood floor, rough ground or in a narrow space. Two people are required to lift the chair. During the lifting period, take the calf rest end sealing plate and backrest cover grooves as the force-bearing point(Please do not lift armrest directly.)

### XII. Instruction for Movement

- Make sure that all the wires are pulled away from the massage chair surface; then press the backrest down to a certain angle (with the center of gravity resting on the wheels), you can push the massage chair forward with hands, move it to a suitable position and gently restore it to the normal angle. (Note: During movement, you must turn off the power button first and then unplug the power cord and the remote controller connection wire).

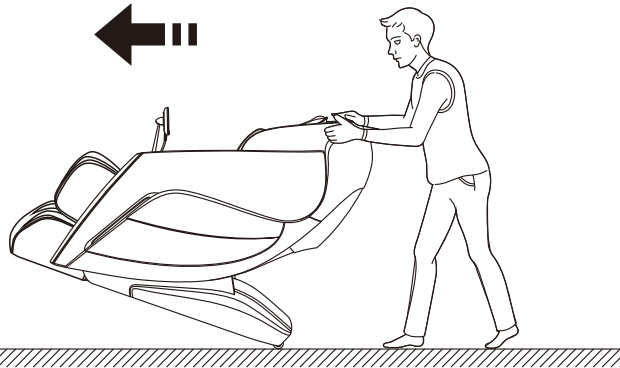

Warning : The rear moving wheels of the massage chair are only suitable for short-distance and slow movement. For long-distance transportation, please use other auxiliary moving tools to move this massage chair!

## Legal notices

### FCC Information

- Any changes or modifications not expressly approved by the party responsible for compliance could void the user's authority to operate the equipment.
- This device complies with Part 15 of the FCC Rules. Operation is subject to the following two conditions:
  - this device may not cause harmful interference, and
  - this device must accept any interference received, including interference that may cause undesired operation.
- This equipment has been tested and found to comply with the limits for a Class B digital device, pursuant to Part 15 of the FCC Rules. These limits are designed to provide reasonable protection against harmful interference in a residential installation. This equipment generates, uses, and can radiate radio frequency energy, and if not installed and used in accordance with the instructions, may cause harmful interference to radio communications. However, there is no guarantee that interference will not occur in a particular installation. If this equipment does cause harmful interference to radio or television reception, which can be determined by turning the equipment off and on, the user is encouraged to try to correct the interference by one or more of the following measures:
  - Reorient or relocate the receiving antenna.
  - Increase the separation between the equipment and receiver.
  - Connect the equipment into an outlet on a circuit different from that to which the receiver is connected.
  - Consult the dealer or an experienced radio/TV technician for help.

This equipment complies with FCC radiation exposure limits set forth for an uncontrolled environment. This equipment should be installed and operated with a minimum distance of 20cm between the radiator & your body. This transmitter must not be co-located or operating in conjunction with any other antenna or transmitter.

## Product specifications

Model: SL-A710

Configure: 11

Name: Massage Chair

Rated voltage: 110-120V~ 60Hz

220-240V~ 50Hz/60Hz

Rated power:220W

Rated time: 20min

Safety structure: Class I

Material description: PVC, PA, steel parts, electric and electron components

MATERIAL	PU	LEATHER	CLOTH	WOOD