

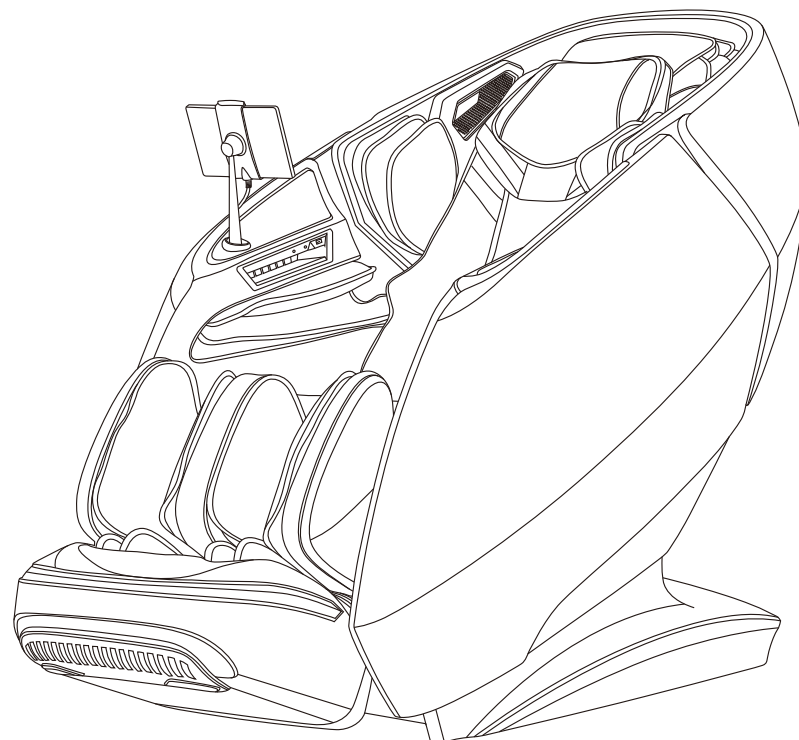

A665-6 MASSAGE CHAIR
OPERATION INSTRUCTIONS

SAVE THESE INSTRUCTIONS



Thanks for purchasing this product. Please read this manual instruction carefully in order to know how to use this product correctly before operation. Please pay more attention to some important safety warning and keep this manual book properly for future use.

Note: Our company reserves the right to change and explain the design of the product. If there is some difference between the product function in market circulation and the description in the manual, it is a normal update of the product, and our company will not inform you otherwise. The specific product function and color shall prevail in kind.

CONTENTS

Before use

Safety precautions	02-04
Installation parts	05-06
Place massage chair	07-08
Before use	09-10
Product structure	11-16

Usage method

Operation Instructions	17-45
End massage	45

Maintain



Cleaning and Maintenance	46
--------------------------	----

Important

Troubleshooting	47
Product Specifications	48

Safety Precautions (must be observed)

- Please read all relevant instructions carefully before use.
- The notes marked here will help you to use the product safely and correctly.
- In order to clearly indicate the extent of harm and damage, precautions are divided into **"Warning"** and **"Caution"** that may be caused by incorrect use. Both of them are important for safety and must be followed.

 Warning	Indicates that serious injury or death may result from improper use.
 Caution	Indicates that misuse may cause minor injury or property damage.

- Please pay attention to the symbol before each safety item.

 Forbidden	Absolute prohibition
--	----------------------

The following populations should not use this product

 Forbidden	<ul style="list-style-type: none"> ■ The device is not intended for use by persons (including children) with physical disabilities, sensory or neurological impairments or who lack experience and common sense, unless they are supervised and instructed in the use of the device by those responsible for their safety. Children must be supervised to ensure they do not play with instruments. ■ Patients with osteoporosis. ■ Patients with heart disease or wearing electronic medical devices such as a pacemaker. ■ People who have a fever. ■ Pregnant women or women on their menstrual period. ■ Patients who are injured or have a skin disease. ■ When unsupervised, any children are under the age of 14 and those unconscious are not allowed to use this product. ■ People who are told by their physicians to have rest or who feel unwell. ■ People whose bodies are wet are forbidden to use this product. ■ This product has a hot surface. Persons insensitive to heat must pay attention when using this product. ■ If the supply cord is damaged, to avoid danger, it must be replaced by a professional from the manufacturer, its maintenance department or similar department
---	---



Safety Precautions (must be observed)

Important safety warnings	
 Warnings	<ul style="list-style-type: none"> ■ Do not allow children to touch any movable part of this product. ■ Use the well-grounded power supply unit suitable for this product. ■ Pull out the plug after use or before cleaning to avoid any physical injury or damage to the product. ■ Operate this product as instructed in this manual. ■ Do not use any parts or accessories which are not recommended. ■ Do not use this product outdoors. ■ Please read the Operation Instructions carefully before operation. ■ Never use this product for any other purpose not listed herein. ■ 20 minutes of usage each time is recommended. ■ Do not use this product if the cover or leather is broken or damaged. ■ Do not drop anything into this product. ■ Never fall asleep while using this product. ■ Do not use this product if you are drunk or feel unwell. ■ Do not use this product within one hour after a meal. ■ Do not use this product with excessive force to avoid any injury.

Safety precautions	
 Caution	<ul style="list-style-type: none"> ■ Check whether voltage is consistent with the specification of this product. ■ Never insert or pull out the plug with a wet hand. ■ Do not let water flow into this product to avoid electric shock or cause damage to this product. ■ Do not pull the power cord when plugging or unplugging it. Rough handling is forbidden. ■ Do not damage the wire or modify the circuit of this product. ■ Do not clean live parts of this product with a wet cloth such as a power switch and plug. ■ Be away from this product in case of power failure to avoid any injury if power is restored suddenly. ■ Stop using this product at once while it works abnormal, and consult your local supplier. ■ Stop using this product if you feel unwell, and consult your health care practitioner.

Storage conditions	
 Caution	<ul style="list-style-type: none"> ■ Storage room temperature: 5 °C to 40 °C. ■ Relative humidity (RH) between 20% and 80%; free of corrosive gases, and a well-ventilated room.

Safety Precautions must be observed

Product service and maintenance	
 Caution	<ul style="list-style-type: none"> ■ This product should be maintained by the service center designated by the manufacturer only. No user should disassemble or maintain it without permission. ■ Do not forget to turn off the main power switch after usage. ■ Do not use this product if the power socket becomes loose. ■ If this product will be left unused for a long period of time, it is necessary to roll up the power cord of this product and store this product in a dry and dust-free environment. ■ Do not store this product at a high temperature or near open flame. Avoid prolonged exposure to direct sunshine. ■ Please clean this product with dry cloth. Never use thinner, benzene or alcohol. ■ The mechanical components of this product are specially designed and manufactured, so no special maintenance is needed. ■ Do not use a sharp object to stab at this product. ■ Do not roll or pull this product on any uneven ground. Instead, it should be lifted before moving. ■ Please use this product intermittently. Do not keep it working continuously for a long period of time.
Operating environment	
 Caution	<ul style="list-style-type: none"> ■ Do not use this product in a very moist environment such as the bathroom. ■ Stop using this product immediately when the ambient temperature changes sharply. ■ Do not use this product in any heavily-dusty or caustic environment. ■ Do not use this product in a small space or a place without good ventilation.
Solutions to ordinary malfunctions	
 Caution	<ul style="list-style-type: none"> ■ If the motor sounds during operation of this product, this is the normal operation sound. ■ If the controller cannot work normally, check whether the plug and the power socket are connected reliably, and whether the power switch is turned on. ■ If the rated working time is over, this product will automatically activate the power-off button; If this product keeps operating for a long period of time, the temperature protector will stop this product automatically. The product can be used again after half an hour.

Installation parts

Armrest installation instructions

1. After powering on, use the Remote control to lie down the backrest to the end.
2. Insert the harness assembly and air pipe on the steel frame assembly into the armrest plug and air pipe joint respectively, and dock them firmly (Figure 1)

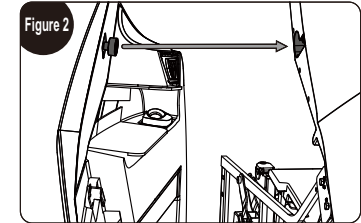
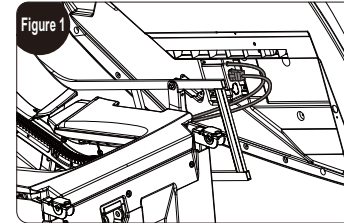

3. First, lift and tilt the front of the armrest, then place the rollers at the rear end of the armrest into the corresponding slots on the side of the capsule (Figure 2), push the armrest towards the upper rear end, and push the roller to the limit position of the slot. (Figure 3)

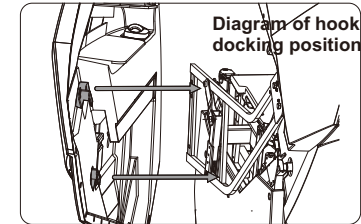
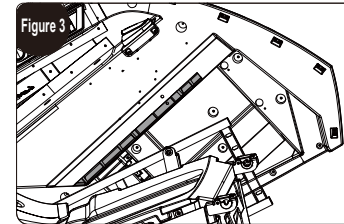

4. Press the front end of the armrest down, and hang the hook position on the armrest to the pipe fittings of the steel frame assembly. The front side screw position of the armrest is aligned with the steel frame assembly and exposed, which means it is assembled in place. (Figure 4) Finally, lock with 2 M5 screws. (Figure 5)

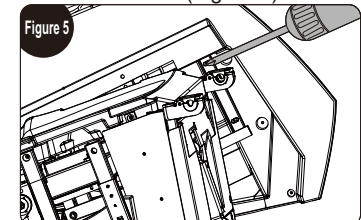
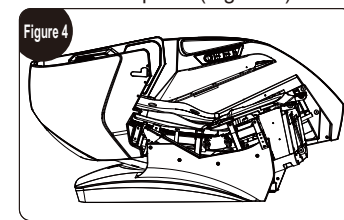

Calf installation instructions

1. Insert the wire of the calf and the air pipe into the sockets on the front end of the steel frame assembly (Figure 1).
2. After the wire docking is completed, open the calf fixing covers on both sides of the steel frame assembly (Figure 2).

Installation parts

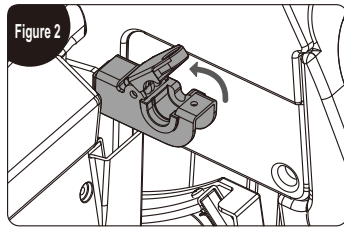
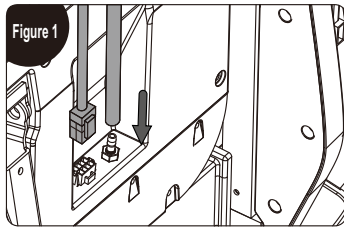

3. Lift the calf into the notch, close the fixing covers, and secure it in place with 2 pieces M5 screws (Figure 3).

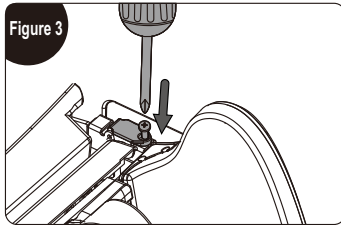

Touchscreen hand control bracket installation instructions

1. Align the bracket with the hole at the front of the armrest (right) and fasten it with M5 screws (Figure 1).
2. Align the bracket decorative piece with the bracket and press down along the bracket rods all the way down (Figure 2).

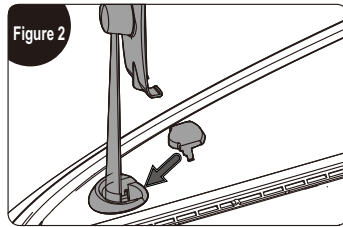
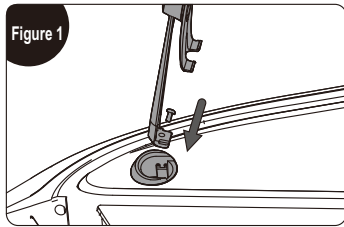

3. After the entire bracket is installed, shake the bracket lightly to confirm whether it is firmly installed; the bracket installation is complete (Figure 3).

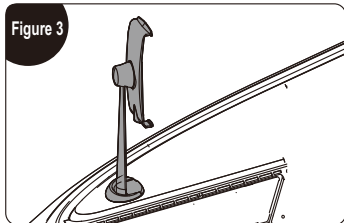

Place massage chair

Installation placement

Make sure there is enough space for the massage chair can be tilted at least 10 cm.

Do not expose the massage chair directly to high temperature environment due to sunlight (such as: in front of heating equipment), and place it to where can avoid high temperature and direct sunlight. It is recommended to lay a soft cushion for long-term use in a designated location. When laying the cushion, the size of the cushion should be enough to cover. Keep the range where the machine touches the floor and the range where your feet touch the floor.

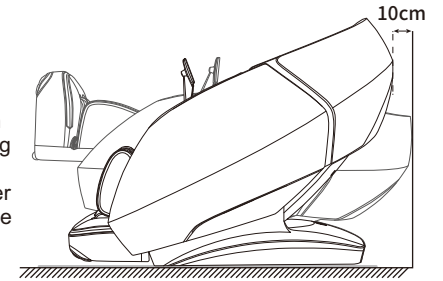

Product lift instruction

Require team work to lift and move the chair to avoid injury.

1. Please lift the massage chair to move it on vulnerable ground such as wooden floor.
2. When moving on a similar wooden floor, it is recommended to lift it. Avoid damage to the casters. When the floor is lifted and moved to the designated position, be careful to keep your hands out of the way to avoid injury, and be careful of your feet being crushed. Do not let go of the unit until the unit is completely flat, the floor may be damaged, therefore, it is recommended to place mats, etc. on the floor.

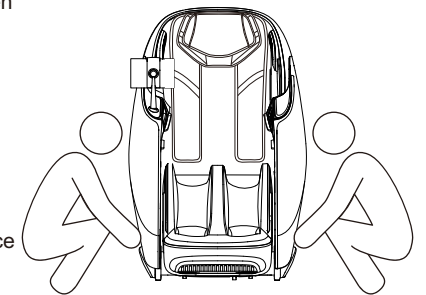

Place massage chair

Move method

Use the rear casters to move the massage chair. Move the chair by tilting it down and backward about 45° as shown in the diagram.

NOTE: Excessive force to title will cause the chair to tip over completely and product damage.

1. Before moving, please shut down the machine properly to reset the whole machine, and then cut off the power.
2. Please keep the chair vacant when moving. (People, pets or clutter will not be able to stay on the chair.)
3. When moving, do not cross a drop barrier higher than 2mm or a gap greater than 5mm.
4. When using casters to move this product, single continuous movement is not supported; if the distance exceeds 50 meters, please make this product move slowly and evenly.

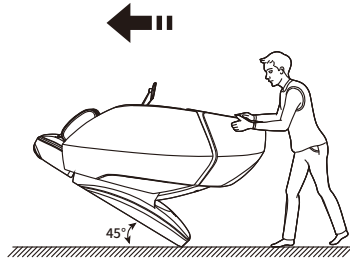

CAUTION

How to disassemble and use headrest cushion and backrest cushion

Using a headrest cushion can reduce the intensity of kneading massage on the neck and shoulders, and you can decide whether to use a headrest cushion according to your needs (recommended to use a headrest cushion). The backrest cushion and the backrest are connected by a zipper (1), and the headrest cushion and the backrest cushion are connected by a zipper (2).

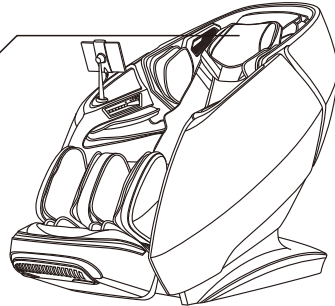
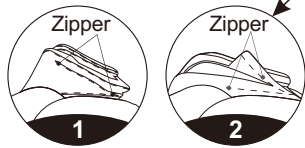

CAUTION

Before use

Check around

Make sure that there are no people, pets and other objects around the unit.

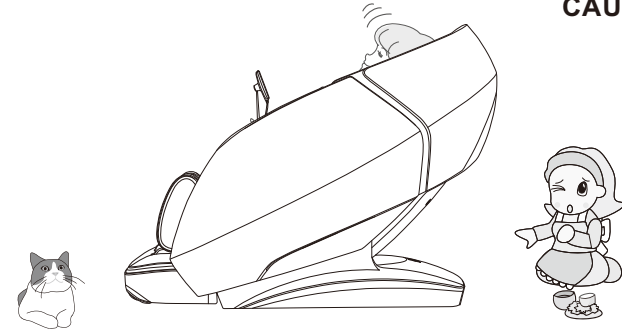

CAUTION

Make sure there are no foreign objects in the gaps of the machine

Before massaging, make sure that no foreign objects are caught in the legs, feet, etc. Under no circumstances allow hands, feet, and head to penetrate into the area between the lower leg mechanism and main body, or the area between the armrest and the capsule. Under no circumstances should hands, feet, or head sink under the fabric or leather covering of the massage area.

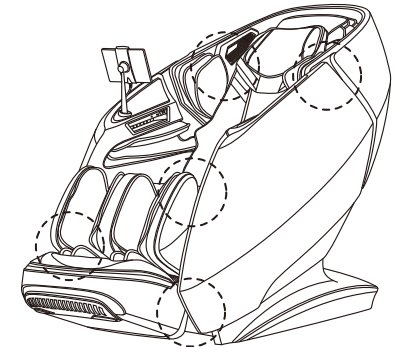

CAUTION

Before use

Turn on the power

CAUTION

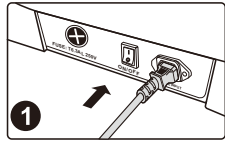

1 Plug in power cord

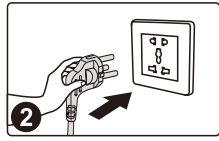

2 Schematic diagram of power on

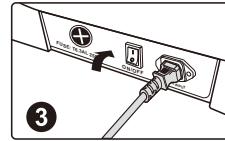

3 Turn on the power switch ("I" position)



Warn

- Please check the power cord and plug for damage before use.
- Please supply power to this product in accordance with the working power requirements of this product's calibration.
- It is strictly forbidden to use a power supply other than the nominal power supply of this product.
- It is strictly forbidden to connect various power conversion devices without authorization to supply power to this product.

Product structure

Description of Components

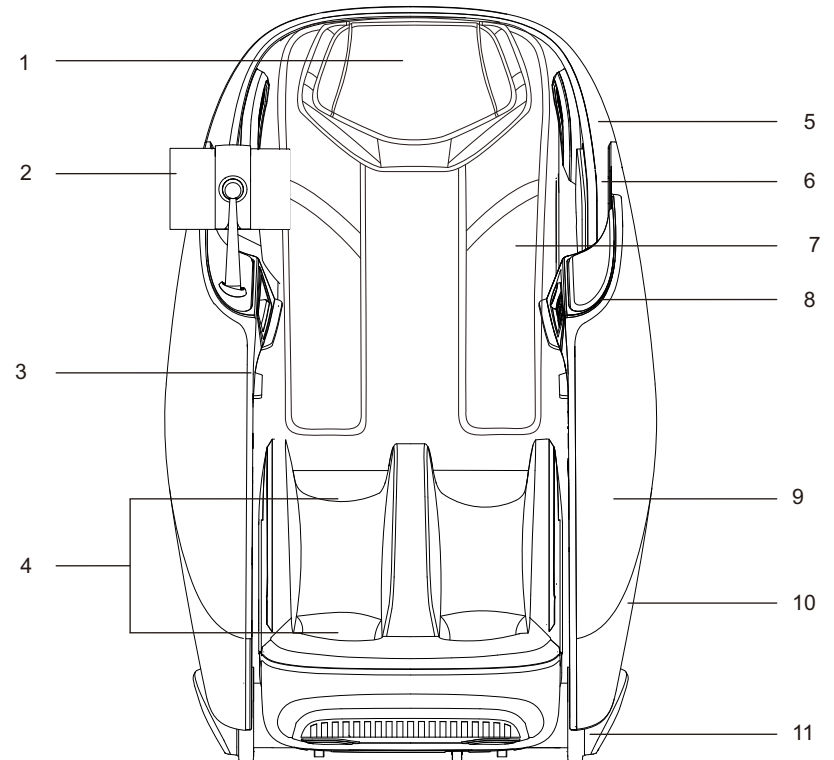

- 1. Head cushion
- 2. Manual controller
- 3. Arm air pressure
- 4. Leg massage components
- 5. Space capsule
- 6. Shoulder air pressure

- 7. Shawl back cushion
- 8. Armrest shortcut keys
- 9. Armrest
- 10. Atmosphere lamp
- 11. Side cover

Product structure

Schematic view of functional distribution

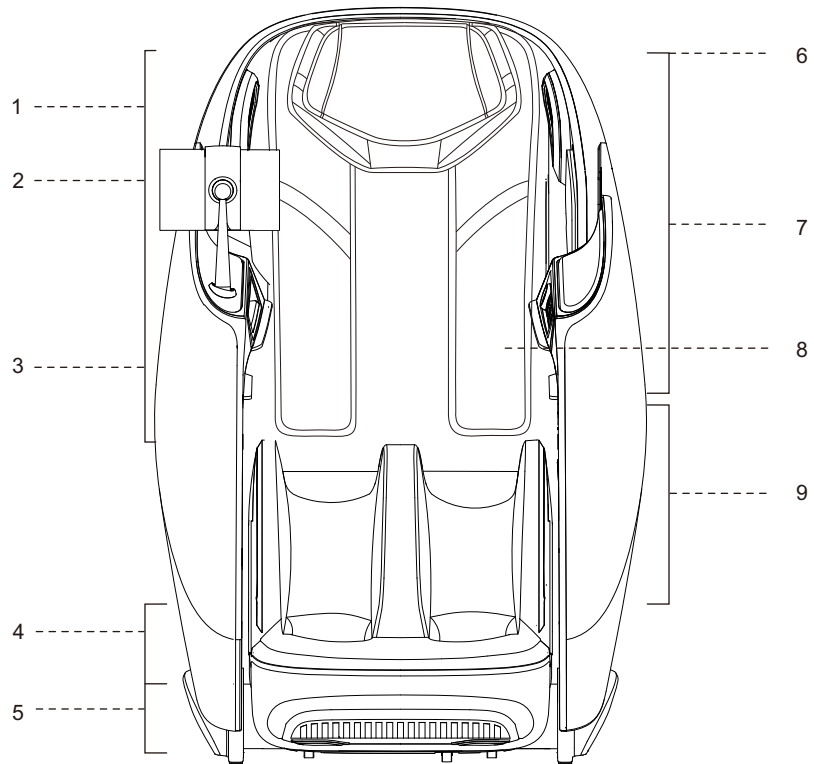

1.Shoulder
• Airbag massage

2.Arm
• Manual bracket
• Mobile phone placement slot
• USB charging port
• Wireless charger

3.Hand
• Airbag massage

4.Leg
• Airbag massage

5.Sole
• Roller massage
6.3D digital audio on both sides of the head
• Music player

• Built-in voice control microphone

7.Head and neck to seat
• Manipulator massage

8.Shoulder, back & waist, abdomen
• Heating function

9.Leg
• Airbag massage
• Kneading massage

Product structure

How to use the shawl

- It is provided with a unique shawl assembly, with innovative heating functions on the shoulder, back, waist and abdomen and heating with graphene. Users can place the shawl at different massage positions according to massage requirements. When the shawl assembly is placed at the shoulder position, it will heat the acupoints such as Bingfeng, Tianzong, Yunmen and Qihu around the shoulder and clavicle by graphene heating, effectively relieving symptoms such as scapulothoracic periarthritis and cough, and removing cold and moisture from shoulder joints.
- When the shawl assembly is placed on the abdomen and back (dual-purpose), through graphene heating, it plays the role of dispelling cold and relieving pain, warming channels and removing blood stasis in the back and abdomen, distributing Qi and blood of the back and abdomen meridian, alleviating the symptoms such as irregular menstruation and dysmenorrhea for women, relieving low back pain and kidney discomfort, warming intestines and stomach and clearing intestinal cold, with a good effect on some people with deficiency of qi and deficiency of spleen and stomach.

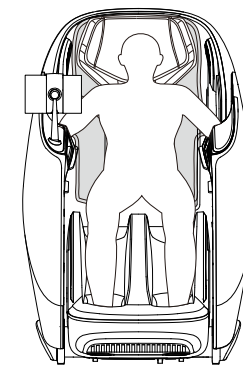
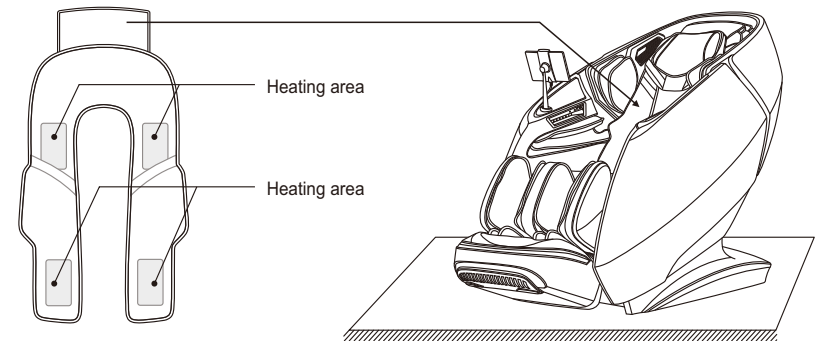

Schematic diagram
of use on back and waist

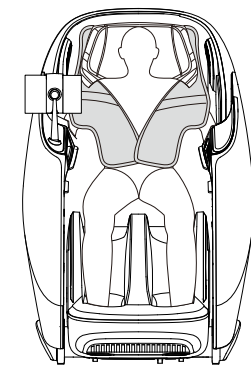

Schematic diagram
of use on shoulder and abdomen

Product structure

I.Remote controller keys instruction

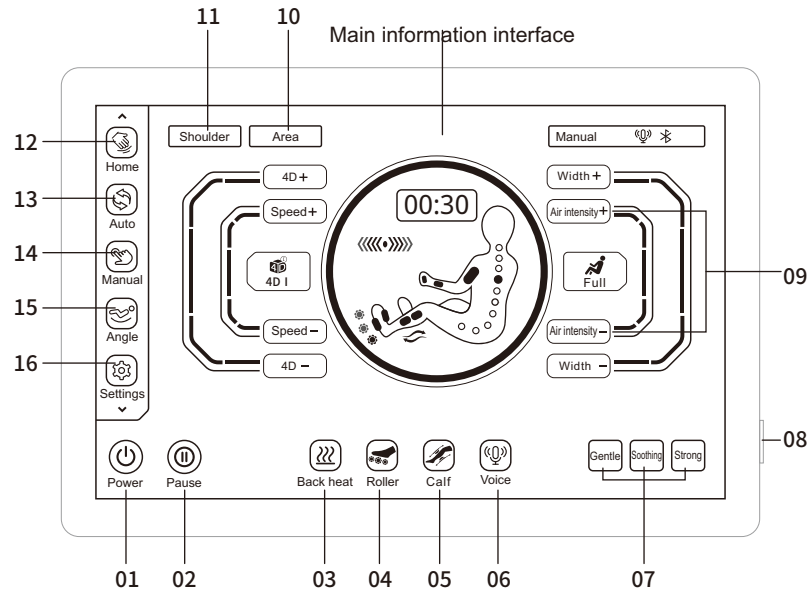

- 01.On/off touch key: Enable or disable the Massage Chair function.
- 02.Pause key: Pause the massage or exit from pause massage
- 03.Back heating key: Enable or disable the Back Heating function.
- 04.Sole roller key: Enable or disable the Sole Roller function.
- 05.Calf kneading key: Enable or disable the Calf Kneading function.
- 06.Voice control key: Wake up voice assistant.
- 07.Intensity selection key: Select one from different automatic massage intensities.
- 08.Button ON/OFF key: Turn on or off the massage chair.
- 09.Air pressure intensity key: Adjust the air pressure.
- 10.Massage area key: The function of selecting massage position.
- 11.Shoulder position adjustment key: Regulate shoulder position and confirm massage criterion
- 12.Current status key: Enter to view current massage chair status.
- 13.Auto key: Enter the automatic massage program selection function.
- 14.Manual key: Enter the manual setting massage function.
- 15.Angle button: Enter the angle adjustment interface to select the sitting posture angle.
- 16.Settings key: Enter the setting menu interface.

Product structure

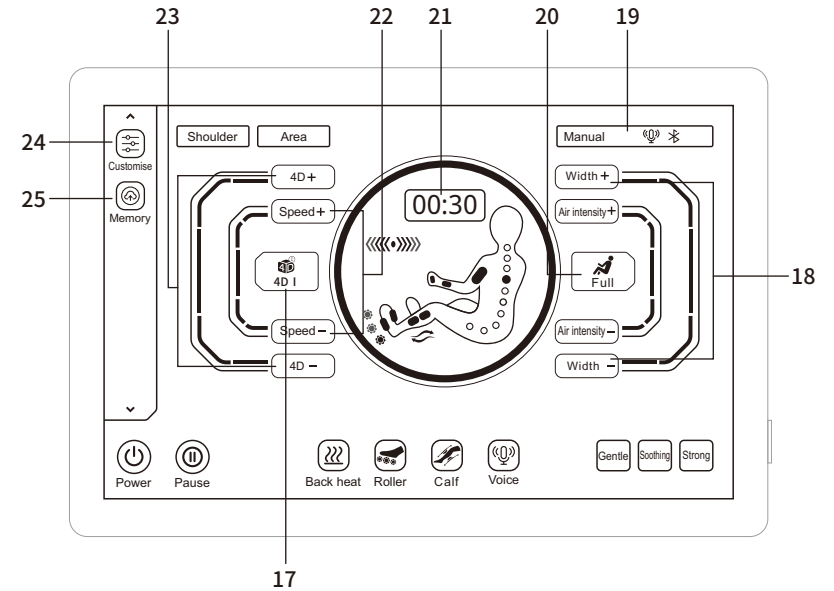

- 17.Massage technique selection key: Select the massage technique.
- 18.Massage width key: Adjust the massage width.
- 19.Status display bar key: Display the massage program status information.
- 20.Air massage selection key: Select air position.
- 21.Time adjustment menu key: Adjust the massage time.
- 22.Massage speed key: Adjust the massage speed.
- 23.4D intensity key: Adjust 4D intensity.
- 24.Custom key: Enter the custom interface.
- 25.Storage key: Enter the storage interface

Product structure

II. Description of armrest shortcut keys

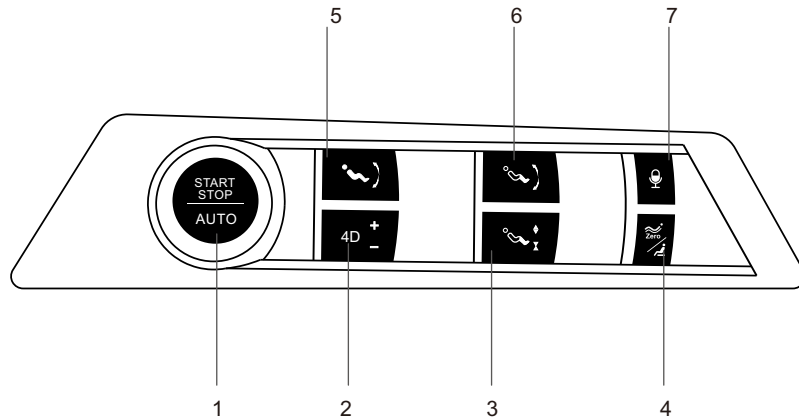

1. Switch
 - Turn on or off the massage chair.
2. 4D+ key
 - Press this key to increase the 4D intensity, up to 5 levels.
 - Lift this key up, the 4D intensity is reduced, and the lowest is 1 level.
3. Calf retractable key
 - Press and hold the button to extend the foot slowly, release it to stop the foot extension.
 - Lift the button to shorten the foot slowly, release it to stop the foot shortening.
4. Zero gravity key
 - Short press this key to automatically adjust the zero gravity angle, two levels can be adjusted. Press and hold for 1 second, the angle returns to the initial angle, the calf is lowered to the lowest position, and the backrest is raised to the highest position.
5. Linkage up and down key
 - Press and hold this button, the backrest rises slowly, and the leg rest slowly descends, release it to stop the backrest rising and the leg rest descending, and the leg rest will automatically detect the foot length.
 - Lift the button and the backrest will slowly descend, and the leg rest will slowly rise. Release it to stop the backrest descending and the leg rest ascending. The leg rest will automatically detect the foot length.
6. Leg rest up and down key
 - Press and hold the button to lower the leg rest slowly, release it to stop the lowering, the leg rest will automatically detect the foot length.
 - Lift the button to raise the leg rest slowly, release it to stop the leg rest rising, the leg rest will automatically detect the foot length.
7. Voice control key
 - Press to turn on or off the voice assistant function, and short press to wake up the voice assistant.

Operation Instructions

III. Start message

1. Press the remote controller side button on/off key or long press the armrest on/off key

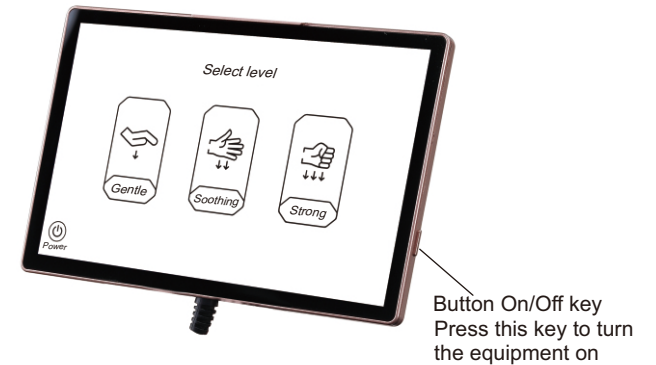

2. After the system is started, select the massage intensity by clicking on any one of the Gentle , Comfort or Strong keys on the remote controller to turn on the massage chair and enter the lying state. If it is not selected within 5 minutes, the massage chair will turn off automatically.

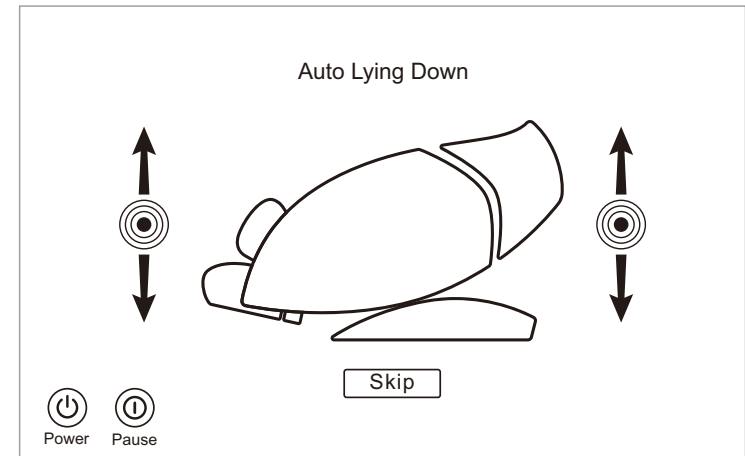

3. For automatic angular adjustment, select the automatic program, then the massage chair will be automatically adjusted to zero-gravity angle, and wait until its adjustment is completed. To skip a step, press the skip key to go directly to the next step.

Operation Instructions

4.Wait until body shape detection is completed, or you can press the skip key **Skip** to skip detection and start massage directly.

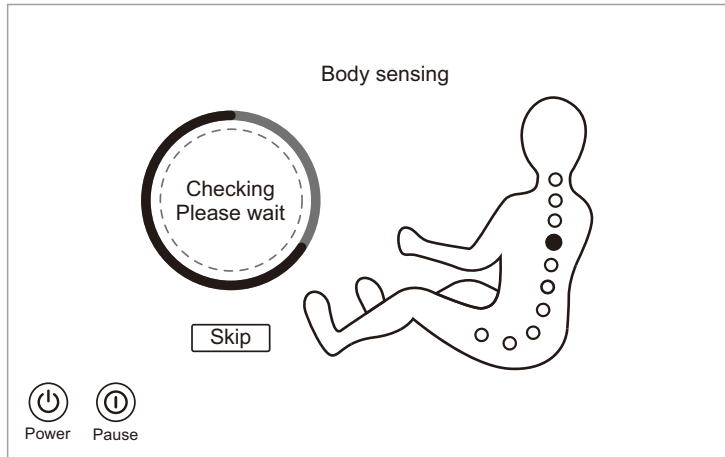

For fine adjustment of shoulder position, after body shape detection, the remote controller or a voice prompt will remind the user of fine adjustment of shoulder position. If the massage roller stops at the shoulder position, directly press the OK key **OK** to start massage. If not, use the Up key **▲** and Down key **▼** to adjust the massage roller to the shoulder position, and then press the OK key **OK** to start the massage. If no operation is made within 20s, directly default the current massage roller position for the shoulder position and start massage.

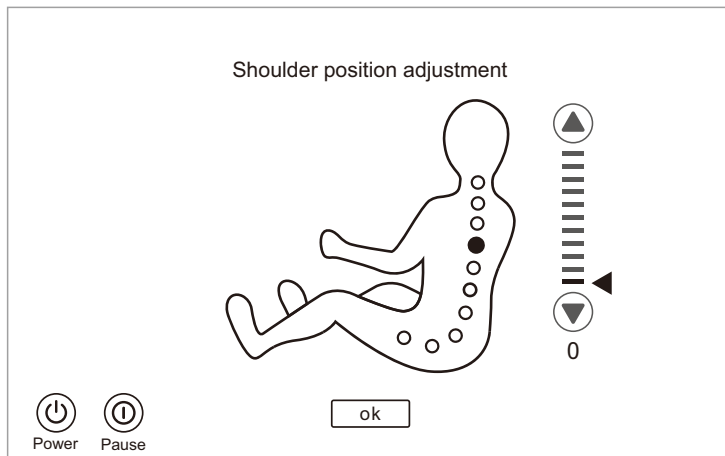

Operation Instructions

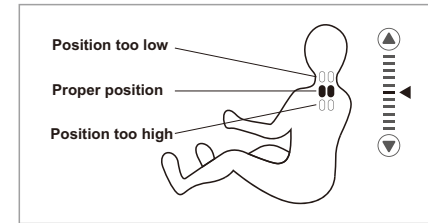

IV.Pause function (please use this function after the equipment is turned on)

After the massage chair is turned on, press the pause key **⏸** to enter the pause state, then all massage functions will be suspended, and press the pause key **▶** again to resume the previous massage state.

Note: In the pause state, all functions do not work except shutdown. If Pause more than 20 minutes, will shutdown reset automatic

V.Automatic program (please use this function after the equipment is turned on)

Automatic program selection

- (1)Select the Automatic key **🔄** in the left menu bar to enter the automatic selection interface.
- (2) In the automatic program selection interface, there are 20 automatic programs to choose from: Total Relax, Neck & shoulder Care, Back Spa, Hips&Legs Fit, Leg&Foot Relieve, Energy Boost, Lunch Break, Sweet Dream, Relieve Muscle, Body Balance, President Cosy, Keep Fit, Superior Enjoyable, Office Regimen, Health Recharge, Full-body Stretch, Chinese Massage, Thai Massage, Spine Traction, Sport Recovery.
- (3) Click the desired automatic program to start the massage.

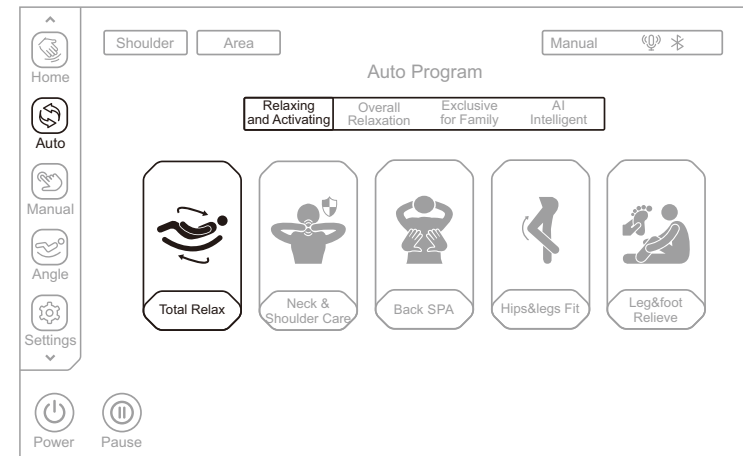

Schematic diagram of automatic massage program selection

Operation Instructions

Massage scenes(Health Maintenance)	
Function	Description
Total Relax	With the aid of flexible guide rails, let the body posture angle closer to lying flat; with the effective anti-arch stretching of 3D movement to the back, achieve zero pressure stretching, effectively relieve lumbar muscle pain, and eliminate fatigue, thus to get a better massage experience, relieve the stress on the body and mind.
Neck & Shoulder Care	Massage the neck and shoulders by means of kneading and stretching techniques mainly, and also the upper back by medical massage, and then press the Jianjing acupoint to relieve cervical spondylosis and achieve the effect of relaxing the muscles of the neck and shoulders. Massage intensity is gentle, suitable for people working in office and suffering from cervical fatigue.
Back SPA	Mainly use anti-kneading, positive and negative kneading techniques to do back-opening massage on the entire back, combined with flapping and shiatsu techniques, the massage intensity is moderate, suitable for people with back congestion and poor blood flow.
Hips&legs Fit	Massage buttocks by kneading and medical massage mainly, and then through patting and kneading, deeply massage buttocks and perineum, to relax the hip muscles and lift the hip, which is suitable for women massage, and also for men for maintenance of prostate.
Leg&foot Relieve	Massage the shoulders and waist by means of kneading, patting, kneading and patting mainly, apply air massage on the legs and feet for squeezing massage, allowing more soothing leg and foot massage, suitable for sedentary people with low stress on the legs and feet, not only relieving the cervical spine, lumbar spine pain of sedentary people, but also soothing the legs and feet. Massage intensity is gentle.

Operation Instructions

Massage scenes(Overall Relaxation)	
Function	Description
Energy Boost	Massage the waist, shoulders and neck by means of kneading, patting, kneading and patting techniques, to awaken the body's vital energy, stimulate physical energy through such deep massage of the whole body with the massage intensity being heavy, which is suitable for people with strong stress, such as athletes, for stimulating the potential before a race.
Lunch Break	Massage the back and waist by means of kneading and patting techniques, and press the Shenyu acupoint, to improve the quality of lunch break, so that the user is more energetic in afternoon work. It is suitable for office workers, and the massage intensity is gentle.
Sweet Dream	Massage the shoulders, neck, back and waist by means of kneading and medical massage techniques, and press the acupoints of Fengchi and Shenyu, to improve the sleep quality and help sleep. It is suitable for people suffering from poor sleep, and the massage intensity is gentle.
Relieve Muscle	Mainly massage the back and waist with flapping and kneading techniques to promote blood circulation and eliminate local muscle soreness. Suitable for people with long-term weight-bearing activities and muscle strain. The massage intensity is moderate.
Body Balance	Mainly massage the shoulders & neck, back & waist with kneading, 4D kneading and shiatsu. Suitable for people who are mentally stressed, physically and mentally unbalanced. The massage intensity is gentle.

Operation Instructions

Massage scenes(Exclusive for family)	
Function	Description
President Cosy	Massage the shoulders, neck, back and waist by means of kneading, patting, kneading and patting mainly, to relieve fatigue, promote blood circulation, and release stress by such deep massage. It is suitable for men, and the massage intensity is moderate.
Keep Fit	Massage the shoulders, neck, waist and hips by means of kneading and finger pressing techniques, through the massage on the whole body, to relax the body and mind, and enjoy the queen-level treatment. It is suitable for women, and the massage intensity is gentle.
Superior Enjoyable	Apply air massage on the whole body, with the foot roller and calf kneading massage. Calf stretching function is canceled, suitable for the elderly and people suffering stress on back. The massage intensity is gentle.
Office Regimen	Massage the shoulders, neck and waist by means of kneading, patting, kneading and patting techniques mainly, to relieve shoulder and neck pain, improve lumbar muscle soreness and maintain lumbar spine through such deep massage. It is suitable for office white-collar and sedentary people, and the massage intensity is moderate.
Health Recharge	Deeply massage the whole body by means of kneading, patting and finger pressing techniques, to promote blood circulation throughout the body and prevent blood clots. It is suitable for people who live at home for a long time and do not like to go out, and the massage intensity is moderately gentle.

Operation Instructions

Massage scenes(AI Intelligent)	
Function	Description
Full-body stretch	The legs, hands and shoulders are mainly clamped by air pressure, and the massage chair automatically adjusts various angles to achieve the effect of stretching and traction. Suitable for people who practice yoga. The massage intensity is moderate.
Chinese Massage	By means of Traditional Chinese medicine massage technique mainly, apply 3D massage on the back and waist so as to promote the blood circulation of the back and waist, soothe the meridians and relieve the blockage of the back and waist through massage. It is suitable for people with back and waist pain, and lumbar muscle strain. Massage intensity is gentle.
Thai Massage	Mainly use calf and backrest electric push rod to clamp legs, hands and shoulders with the aid of air massage, and then apply stretching massage, while the movement holds against the back and waist for 3D medical massage, so that the body is in the Thai stretching state. It is suitable for people under high stress to improve their head-down on chest and humpback. Massage intensity is strong.
Spine Traction	Mainly use the calf, backrest electric push rod and air pressure to clamp the human body's legs, hands and shoulders, and then pull the spine to different angles. Can improve the deformation and curvature of the spine. Strong massage.
Sport Recovery	Massage the shoulders, neck and back and waist by means of kneading, patting and finger pressing techniques. At the same time, drag the calves to achieve the function of knee joint movement. Such deep massage can obtain the effect of exercise. It is suitable for people with less exercise, and the massage intensity is moderate.

Operation Instructions

VI.remote program (please use this function after the equipment is turned on)



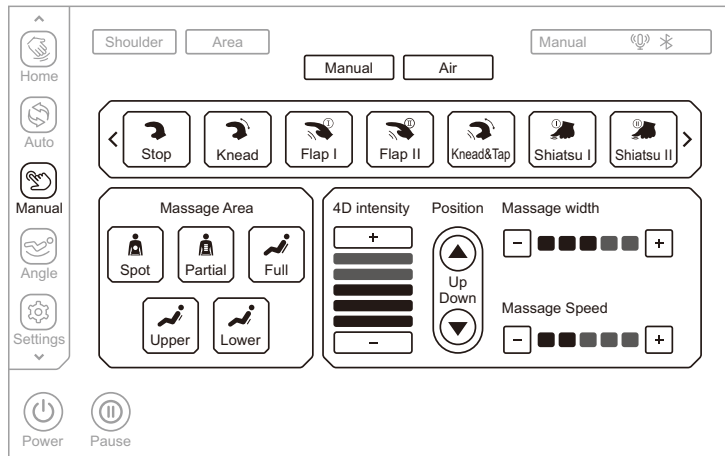

Remote program selection

Select the remote key  in the left menu bar and click to enter the remote menu to select massage technique, massage area, 4D intensity, massage hand adjustment, massage width, massage speed, air massage, air intensity and other massage functions.







1. In the massage technique menu, a total of 11 options are available, including kneading, patting I, patting II, kneading and patting, finger pressing I, finger pressing II, shoulder grasp, 4DI, 4DII, 4DIII and 4DIV. (Note: Click the "leftward arrow <" and rightward arrow >" button in the remote adjustment menu to scroll left and right to display more massage techniques).





Remote program - Schematic diagram of technique selection

Function	Massage roller adjustment	
4D I 	Speed and strength.	Adjustable speed in five gears Adjustable width in five gears Adjustable intensity in five gears
4D II 	Speed and strength.	
4DIII 	Speed, width and strength.	
4DIV 	Speed, width and strength.	

Operation Instructions

Function	Massage roller adjustment	
Stop	Press this key to massage without any technique.	-Adjustable speed in five gears -Adjustable width in five gears -Adjustable intensity in five gears
Knead 	The speed and strength can be adjusted.	
Flap I 	The speed, width and strength can be adjusted.	
Flap II 	The speed, width and strength can be adjusted.	
Knead&Tap 	The speed and strength can be adjusted.	
Shiatsu I 	The speed, width and strength can be adjusted.	
Shiatsu II 	The speed, width and strength can be adjusted.	
Grasp 	The speed and strength can be adjusted.	

Note: You can also click the massage technique key  in the "Current Status"  interface to select the corresponding massage technique in the pop-up menu for massage (this function is a shortcut for switching massage techniques in the current status page of the remote program - technique adjustment).

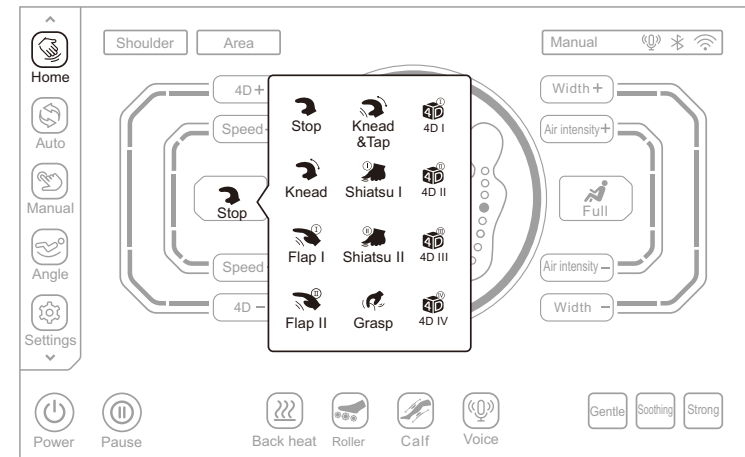

Current Status - Schematic diagram of technique selection

Operation Instructions

The massage area menu has five options: Spot, Partial, Full, Upper and Lower. Select the corresponding massage area for massage.

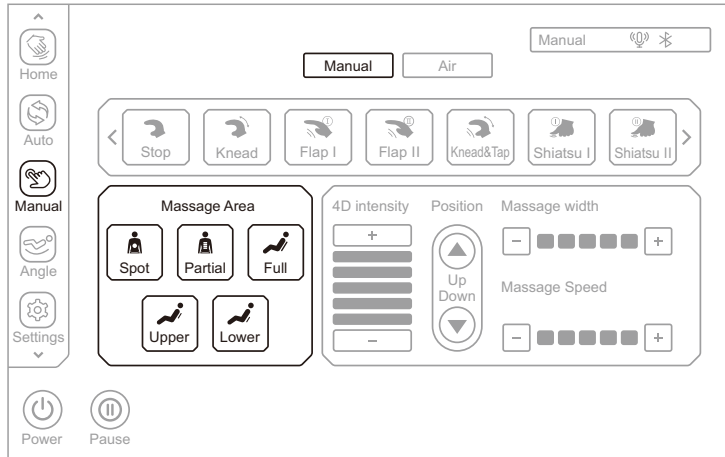

Remote program - schematic diagram of massage area selection

Key	Description
	Fixed-point massage at fixed-point position.
	Small-scope local massage back and forth.
	Full back massage back and forth.
	Upper back massage back and forth.
	Lower back massage back and forth.

Note: You can also click the massage area key **Area** in the "Current Status" interface to select the corresponding massage area in the pop-up menu for massage (this function is a shortcut for switching massage areas in the current status page of the remote program - massage area).

Operation Instructions

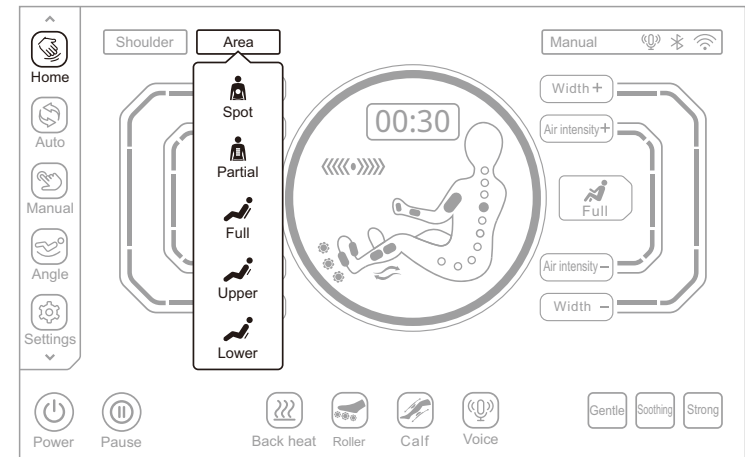

Current Status - Schematic diagram of massage area selection

3. You can adjust 4D intensity in the 4D intensity menu. There are 1~5 gears available for adjustment with 1 being the weakest and 5 being the strongest. The stronger the 4D intensity, the higher the massage roller ejection and the greater the massage strength. Select plus key **+** or minus key **-** to reduce the 4D intensity.

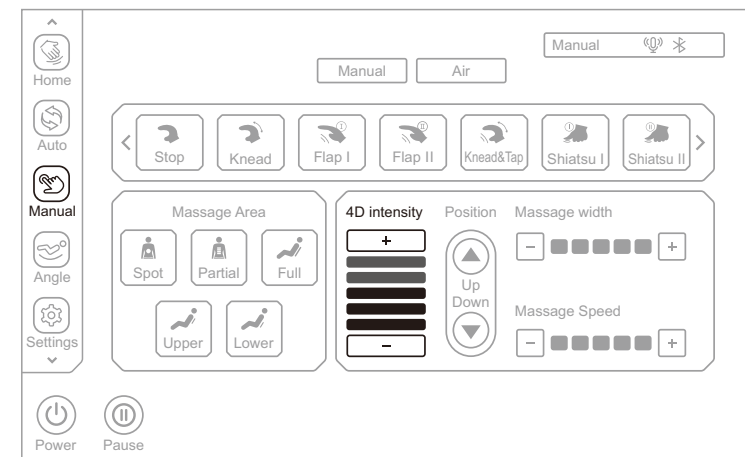

Remote program - schematic diagram of 4D intensity

Operation Instructions

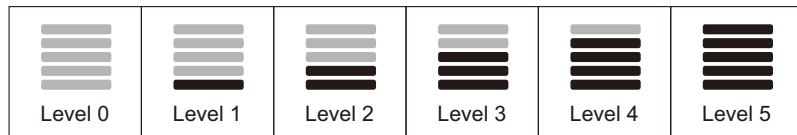

Key	Description
+	Press this key to increase 4D intensity which is adjustable from 1 to 5.
-	Press this key to decrease 4D intensity which is adjustable from 1 to 5.

Note: You can also select the 4D intensity + key **4D +** or 4D intensity - key **4D -** the "Current Status" interface to adjust the 4D intensity. (This function is a shortcut to the 4D intensity in the current status page of the remote program-4D intensity).

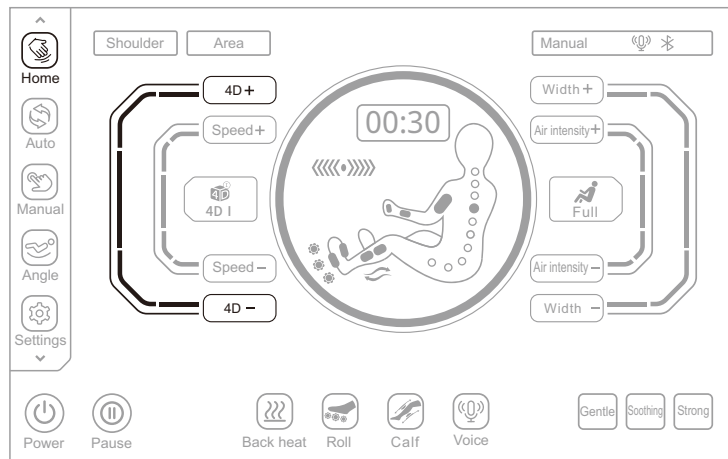

Current Status - remote program-4D intensity

Key	Description
4D +	Press this key to increase 4D intensity which is adjustable from 1 to 5.
4D -	Press this key to decrease 4D intensity which is adjustable from 1 to 5.

Operation Instructions

4. In the spot and local message section, adjust the manipulator, select the up arrow or the down arrow to fine-tune the position of the manipulator upward or downward.

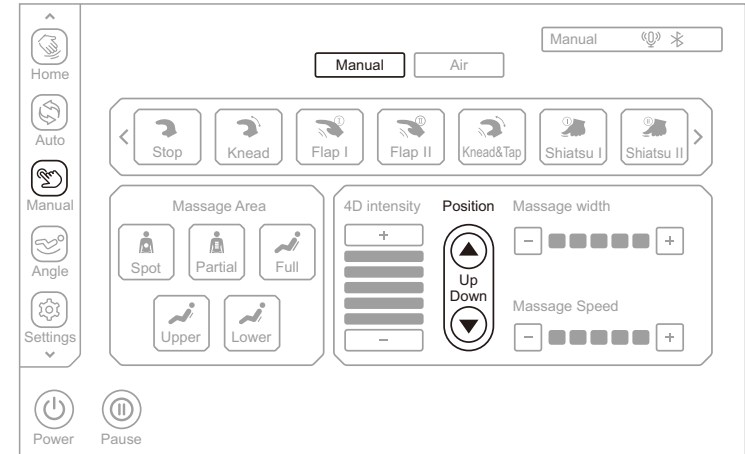

Remote program - schematic diagram of message hand adjustment

5. For message width, as shown in the figure below, select the message width to adjust.

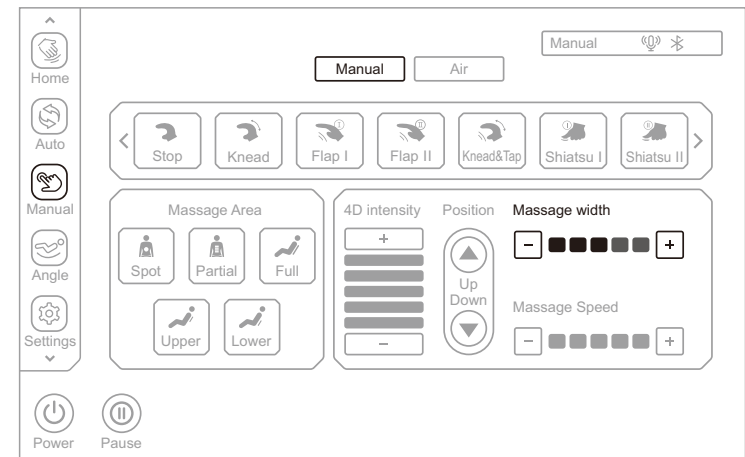

Remote program - schematic diagram of message width

Operation Instructions

(1)The width can be adjusted only when the user enters the remote mode in selecting message technique or massage area.

(2)The massage width is available from 1 to 5 gears, with 1 being the narrowest and 5 being the widest. Please use the following massage techniques: PattingI, PattingII, Finger PressingI, Finger Pressing II, 4D III and 4D IV.

Level 0	Level 1	Level 2	Level 3	Level 4	Level 5
Key	Description				
+	Press this key to increase massage width which is adjustable from 1 to 5.				
-	Press this key to decrease massage width which is adjustable from 1 to 5.				

Note: You can also select the massage width + **Width+** key or the massage width - **Width-** key in the "Home" interface to adjust the massage width.

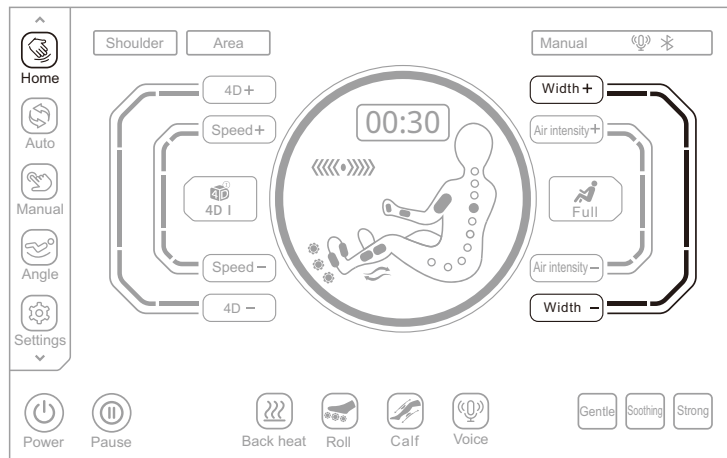

Home - Schematic diagram of massage width

Operation Instructions

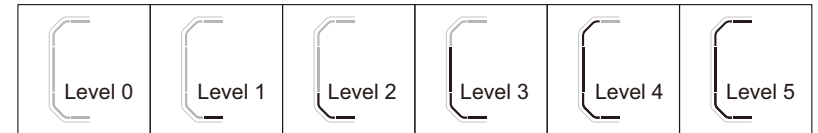

Key	Description
Width +	Press this key to widen the massage width, the width can be adjusted from 1 to 5 levels.
Width -	Press this key to narrow the massage width, and the width can be adjusted from 1 to 5 levels.

6.For message speed, as shown in the figure below, select the massage speed to adjust.

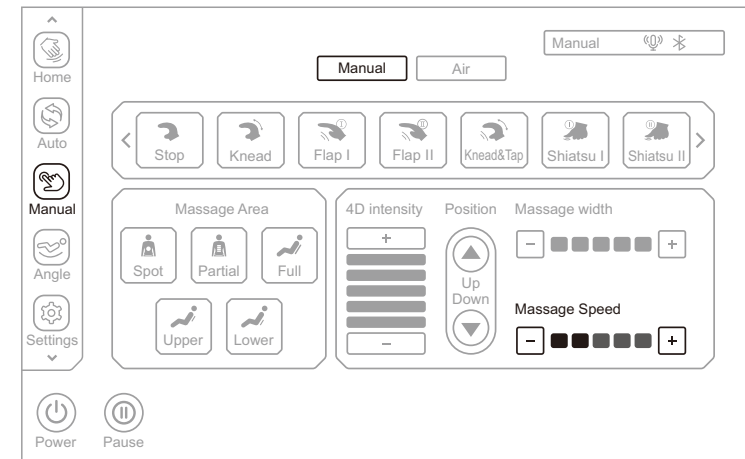

Remote program - schematic diagram of massage speed

(1)The speed can be adjusted only when the user enters the remote mode in selecting message technique or massage position.

(2)The massage speed is available from 1 to 5 gears, with 1 being the fastest and 5 being the slowest. The speed cannot be adjusted when the massage technique stops.

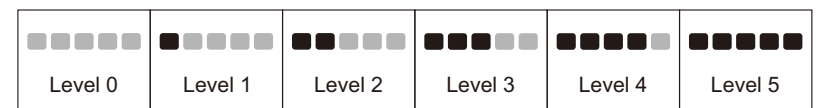

Operation Instructions

Key	Description
	Press this key to increase massage speed which is adjustable from 1 to 5.
	Press this key to decrease massage speed which is adjustable from 1 to 5.

Note: You can also select the massage speed + key or massage speed - key in the "Current Status

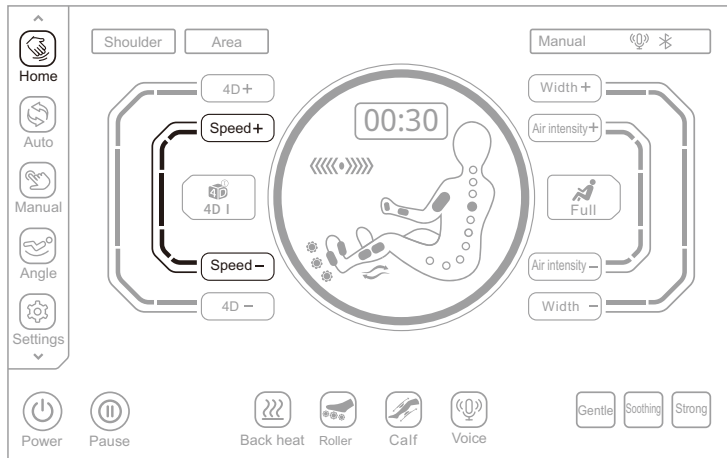

Current Status - Schematic diagram of massage speed

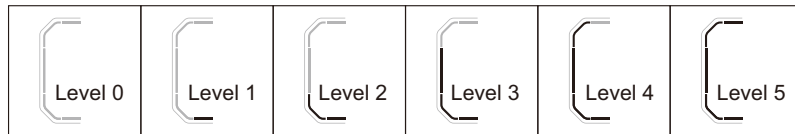

Key	Description
	Press this key to increase massage speed which is adjustable from 1 to 5.
	Press this key to decrease massage speed which is adjustable from 1 to 5.

Operation Instructions

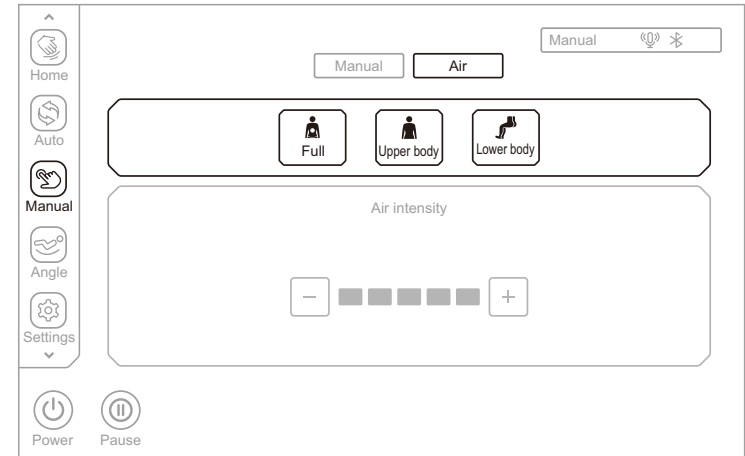

7. For air massage, as shown in the figure below, enter the air massage menu to select the air mode. The air modes include upper body, lower body, and whole body air massage. The air function will be disabled when all above modes are off.

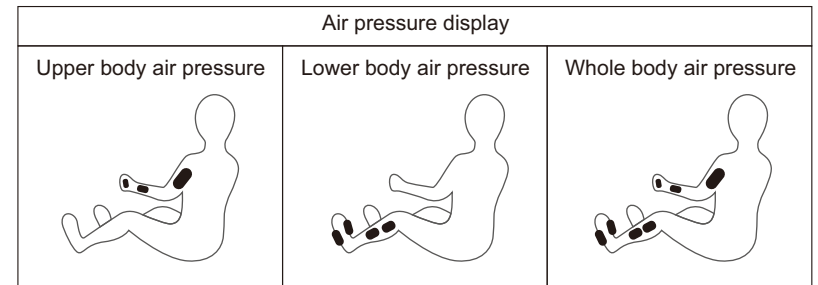

Key	Description
	Press this key to enable or disable the whole body air massage function.
	Press this key to enable or disable the upper body air massage function.
	Press this key to enable or disable the lower body air massage function.



Operation Instructions

Note: You press also air massage key  in the "Current Status  " interface, and select corresponding air mode in the pop-up menu. (This function is a shortcut to the air massage in the current status interface of the remote function - air massage.)

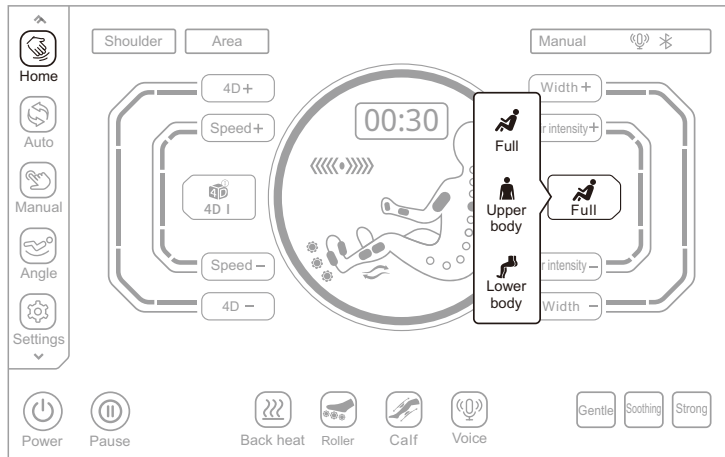

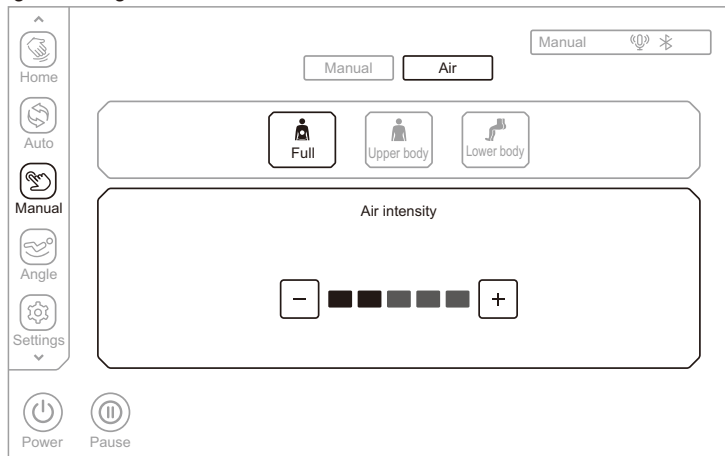

Current status - Schematic diagram of air massage

8. For air intensity adjustment, the air function shall be turned on so as to adjust the air intensity, with a total of five adjustable levels, with 1 being the weakest and 5 being the strongest.

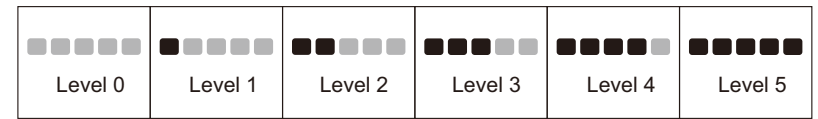

Operation Instructions



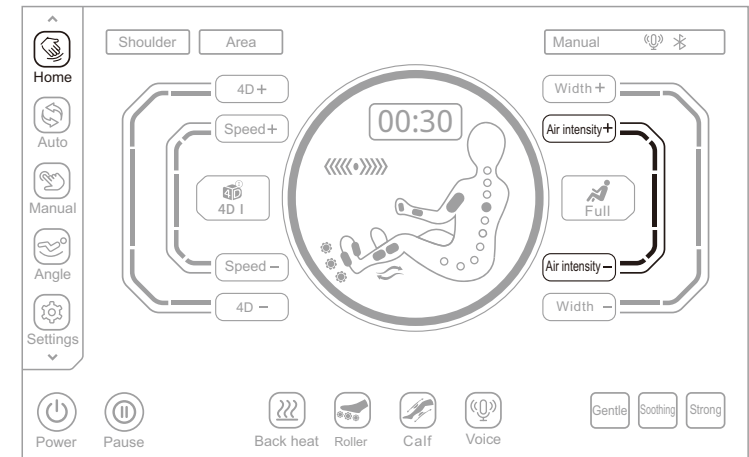

Key	Description
	Press this key to increase the air intensity which is adjustable from 1 to 5.
	Press this key to decrease the air intensity which is adjustable from 1 to 5.

Note: You can also select the air pressure intensity +  key or the air pressure intensity -  key in the "Home  " interface to adjust the air pressure intensity. The air pressure intensity is divided into 5 levels.

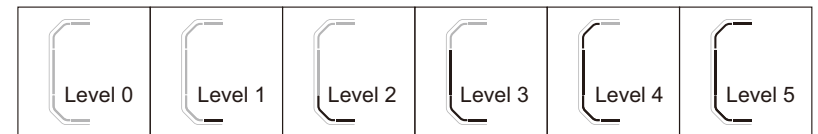

Home - Schematic diagram of air pressure intensity



Key	Description
	Press this key to increase the air pressure intensity, the intensity can be adjusted from 1 to 5 levels.
	Press this key to weaken the air pressure intensity, the intensity can be adjusted from 1 to 5 levels.

Operation Instructions

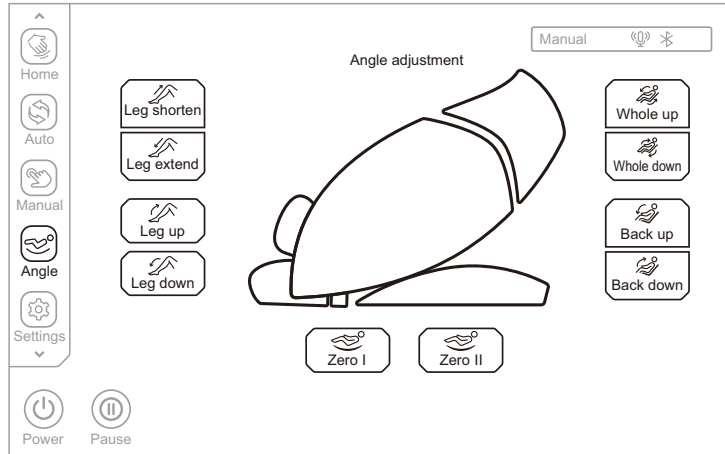

VII. Seat adjustment

Click the "Angle"  button in the menu bar on the left side of the display screen to enter the angle adjustment interface, which includes leg rest telescoping, footrest telescoping, leg rest lifting, linkage lifting, backrest lifting, zero gravity, and other massage functions.





Schematic diagram of sitting posture adjustment

1.Zero-gravity adjustment



Key	Description
 Zero I	Zero-gravity 1 key: automatically adjust the position of leg unit and backrest unit to zero-gravity 1 position.
 Zero II	Zero-gravity II key: automatically adjust the position of leg unit and backrest unit to zero-gravity II position.

2.Leg unit extension/shortening adjustment



Key	Description
 Leg shorten	Leg unit shortening key: remotely adjust shortening of the leg unit; press and hold this key to move the leg unit up slowly and stop when released.
 Leg extend	Leg unit extension key: remotely adjust extension of the leg unit; press and hold this key to move the leg unit down slowly and stop when released.

Operation Instructions



3.Leg unit extension/shortening adjustment

Key	Description
 Leg up	Leg unit Up key: press and hold this key to slowly raise the leg unit, and release it to stop rising; after the leg unit rising action is completed, the leg unit will automatically detect the foot length.
 Leg down	Leg unit Down key: press and hold this key to slowly lower the leg unit, and release it to stop lowering; after the leg unit lowering action is completed, the leg unit will automatically detect the foot length.

4.Linkage lifting Angle adjustment

Key	Description
 Whole up	Linkage Up key: press and hold this key to slowly raise the backrest unit while slowly lowering the leg unit, and release it to stop raising the backrest unit or lowering the leg unit; after the linkage rising action is completed, the leg unit will automatically detect the body height.
 Whole down	Linkage Down key: press and hold this key to slowly lower the backrest unit while slowly raising the leg unit, and release it to stop lowering the backrest unit or raising the leg unit; after the linkage lowering action is completed, the leg unit will automatically detect the body height.

5.Backrest unit angular adjustment

Key	Description
 Back up	Backrest unit Up key: press and hold this key to slowly raise the backrest unit and release it to stop rising.
 Back down	Backrest unit Down key: press and hold this key to slowly lower the backrest unit and release it to stop lowering.

Operation Instructions

VIII. Setting (please use this function after the equipment is turned on)

Click the "Settings" button in the menu bar on the left side of the display screen to enter the setting interface, can view the product number, software version number, ID code and firmware version number. The interface includes setting functions such as voice control, language selection, and Bluetooth.

1. Product model, software version, product serial number, and firmware version show the information of current device.

2. Bluetooth (Operation Instructions for Bluetooth Speaker Play)

Click Bluetooth switch to enable or disable the Bluetooth function. After pairing and connecting the sound source device with Bluetooth function (such as mobile phone, MID tablet, etc.) with the Bluetooth module of the massage chair, the music played by the sound source device can be wirelessly transmitted to the sound system of the massage chair through Bluetooth for music playing.

1. Enter the smart device main menu. Open "Settings" and select the "Bluetooth" option. Open "Bluetooth", and Bluetooth will automatically "Search for a New Bluetooth Device".

2. The smart device will search for the corresponding Bluetooth model (e.g. IMCM-XXXX). Click the "Match" button. If you are asked whether to match with the device, you just select "Match" to complete matching.

3. Turn on "Music Player" in the smart device and select the song to play.

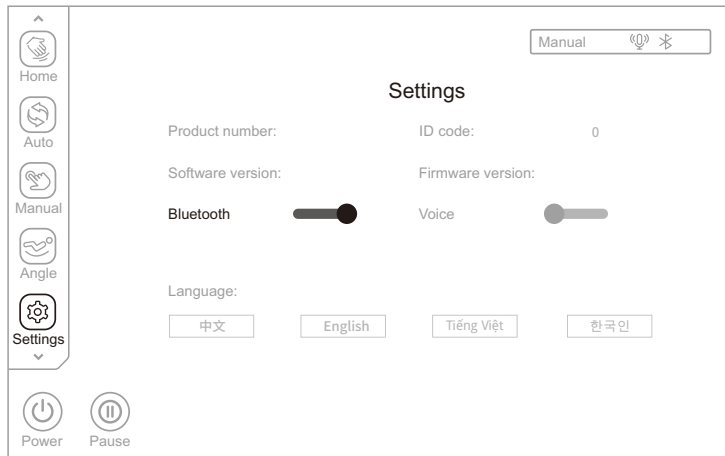

Schematic diagram of Setting

Operation Instructions

2. Voice Control

Click Voice Control switch to enable or disable the Voice Control function. After enabling the voice function, you can control the massage chair by voice according to the content of the voice entry.

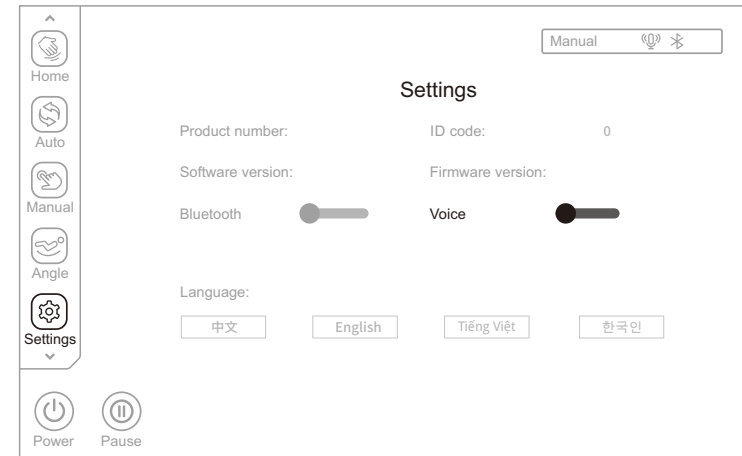

3. Language selection

The language is Chinese by default. English, Vietnamese, Korean is optional.

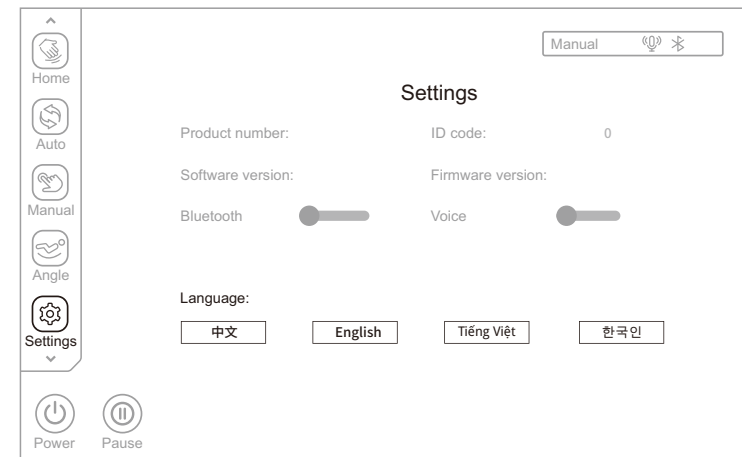

Operation Instructions

(1) Near the left armrest, say "Hi Alice" or "Hey Alice" to wake up the voice assistant, or press the voice key  on the left armrest to wake up the voice assistant, and the voice assistant replies "I am here" to indicate that it has been awakened.

(2) After waking up the voice assistant, please speak the command within 6 seconds to realize the function control of the massage chair. After the voice assistant responds to the command, you can continue to speak the command. The interval between two adjacent commands cannot exceed 6 seconds, otherwise the voice assistant needs to be re-awakened.

Voice Control Entry		
Entry: "Hi Alice" or "Hey Alice". Answer: I am here.		
No.	Voice control entry	Answer entry
1	Massage on	Answer: Ok, Massage on
2	Massage close	Answer: Ok, Massage close
3	Total Relax	Answer: Ok, Total Relax
4	Energy Boost	Answer: Ok, Energy Boost
5	Sweet Dream	Answer: Ok, Sweet Dream
6	Neck & Shoulder Care	Answer: Ok, Neck & Shoulder Care
7	Lunch Break	Answer: Ok, Lunch Break
8	Thai Massage	Answer: Ok, Thai Massage
9	Open the air pressure	Answer: Ok, Open the air pressure
10	Close the air pressure	Answer: Ok, Close the air pressure
11	Up the seat position	Answer: Ok, Up the seat position
12	Down the seat position	Answer: Ok, Down the seat position
13	Change the other mode	Answer: Ok, Change the other mode
14	Go little down	Answer: Ok, Go little down
15	Go little up	Answer: Ok, Go little up

Note: commands 14 and 15 can only be used after command 13.

Operation Instructions

IX. Custom (please use this function after the equipment is turned on)

Click the "Custom  " key in the menu bar on the left side of the display to enter the custom setting interface and select either Custom I or Custom II (only if the corresponding custom has been previously set and saved) for massage.

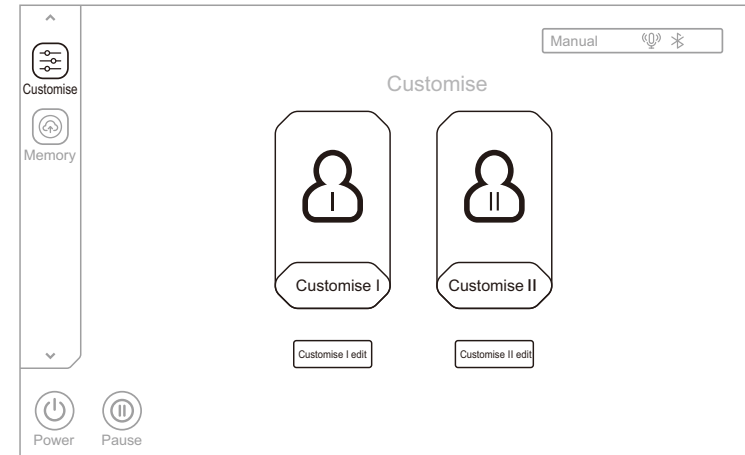

Schematic diagram of Custom

Click Custom I Setting or Custom II Setting to enter the Custom Setting interface, then select the preferred massage technique whose icon will be highlighted after selection, and select the massage interval, 4D intensity, air massage, massage width, massage speed, air intensity, back heating, calf kneading and other functions, then click Save to save the current settings as Custom I and Custom II. After the settings are saved successfully, the custom program will be immediately available and can be used for the next massage by clicking the saved custom program.

Operation Instructions

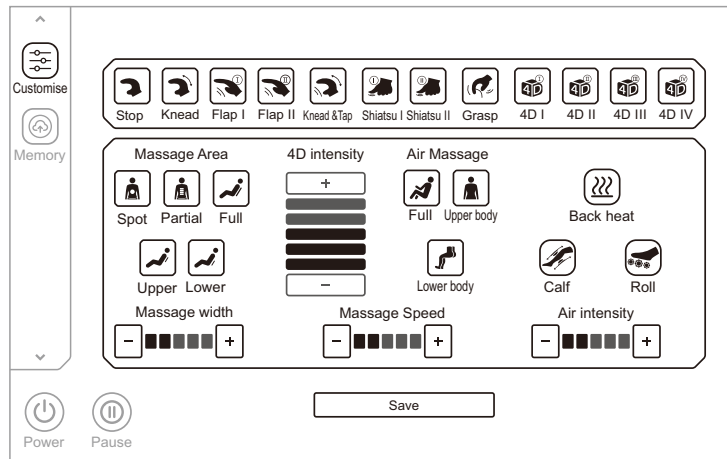

X.Other function (Please use this function after power on)

In the "Home" interface, click the "Back heat" button to turn on or off the back heating function (for graphene heating), and it will warm after 3 minutes of turning on the heating function.

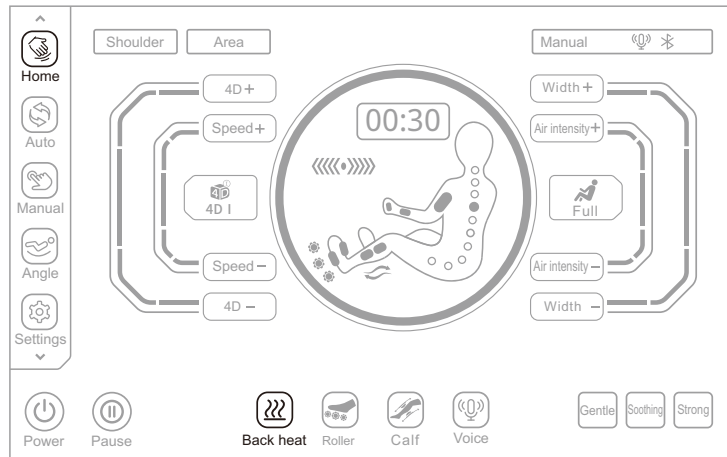

In the "Home" interface, click the "Roll" button to turn on or off the foot roller massage function, with three adjustable speeds.

Operation Instructions

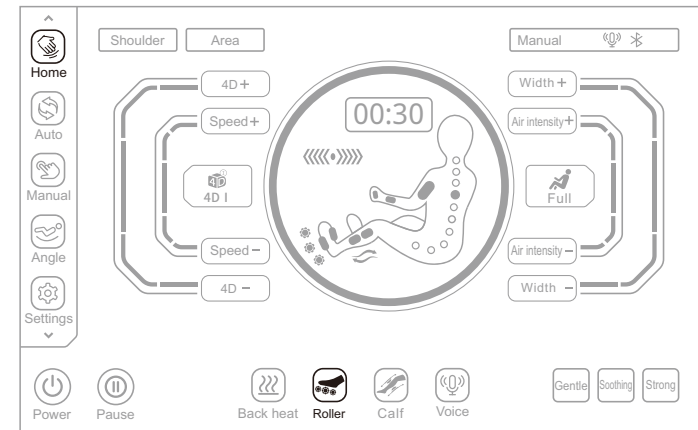

Key	Description
 Level 1 Level 2 Level 3	Press this key to enable or disable the Sole Roller function. Press it for the first time to start Level 1 speed; press it for the second time to start the Level 2 speed; press it for the third time to start the Level 3 speed; and press it for the fourth time to disable the Sole Roller function, which are switched cyclically.

In the "Home" interface, click the "Calf" button to turn on or off the calf kneading massage function; there are kneading and airbag squeezing massage functions on the inside and outside of the calf, which can relieve the stiffness or tension of the calf muscles caused by standing for a long time.

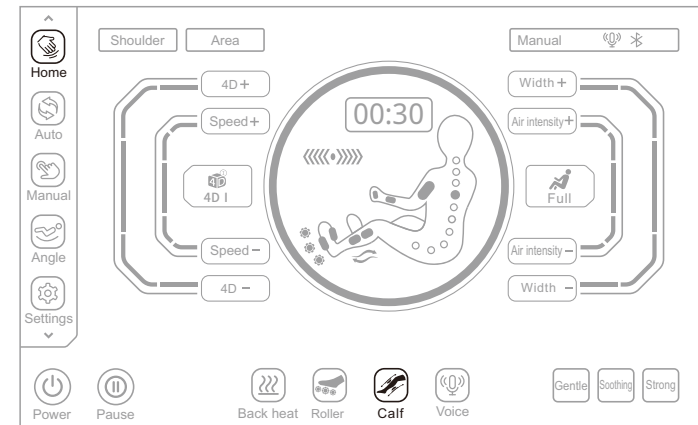

Operation Instructions

In the "Home"  interface, click the "Voice"  button to wake up the voice assistant.

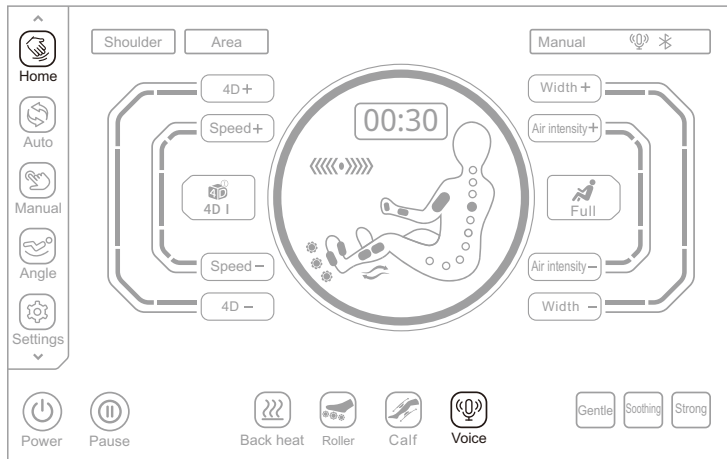



XI.Storage (please use this function after the equipment is turned on)

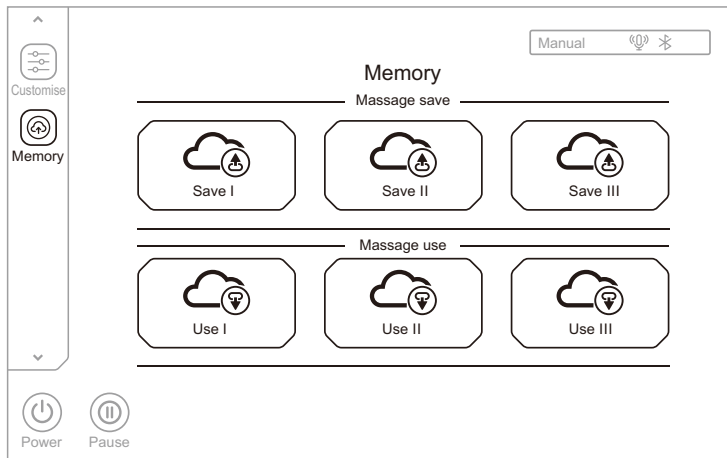

Click the "Storage"  key in the menu bar on the left side of the display to enter the message function storage selection interface, with two categories including message function storage and message function call. Message storage includes: Storage I, Storage II and Storage III. Message call includes: Call I, Call II and Call III



Operation Instructions

Key	Description
	Storage: Saving the currently running massage program, including automatic program, massage technique, air mode and intensity, position and angle of leg unit and backrest unit, and other massage functions.
	Call: Calling the previously saved massage program, including automatic program, massage technique, air mode and intensity, position and angle of leg unit and backrest unit, and other massage functions.

XII.End massage

During massage, press the remote controller touch switch key  or press the right armrest switch key  to turn the equipment off. Immediately turn off all massage functions, reset the backrest unit and the leg unit, or when the massage timing time arrives, all massage functions will be automatically turned off, with the backrest unit and the leg unit not reset.

Cut off the whole machine power supply, as shown in the figure (Schematic diagram of power switch position of the whole machine).

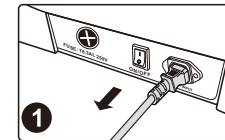

Turn off the power switch ("0" position)

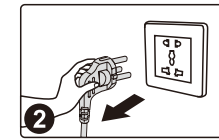

Schematic diagram of pulling out the power plug

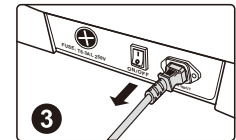

Remove the product connection power cord

Cleaning and Maintenance

Cleaning synthetic leather and plastic parts

Wipe the leather with a soft, dry cloth.

- Do not use chemicals such as thinner, gasoline, alcohol, etc. to clean the unit.
- When using commercially available leather care products (rags), please follow the instructions for use.
- If synthetic leather is particularly dirty, wipe it in the following way.
 - ① Immerse a soft cloth in water or hot water containing 3% to 5% neutral detergent, then wring it out thoroughly.
 - ② Use the above soft cloth to wipe the leather surface.
 - ③ Wipe off the cleaning solution with a cloth soaked in clean water and thoroughly wrung out.
 - ④ Wipe with a wrung soft cloth.
 - ⑤ Let it air dry naturally.
- When it is difficult to remove stains, please immerse commercially available melamine foam in neutral detergent, and then wipe the machine with it.
- Do not use a hair dryer to dry the surface.
- Be careful when wiping the machine with denim and colored fabrics, as the color of the fabric will stain the surface of the synthetic leather.
- Do not keep these parts in contact with plastic for a long time, as this will cause discoloration.
- Synthetic leather may be discolored, so when using hair dye, please cover the touched part with a towel.

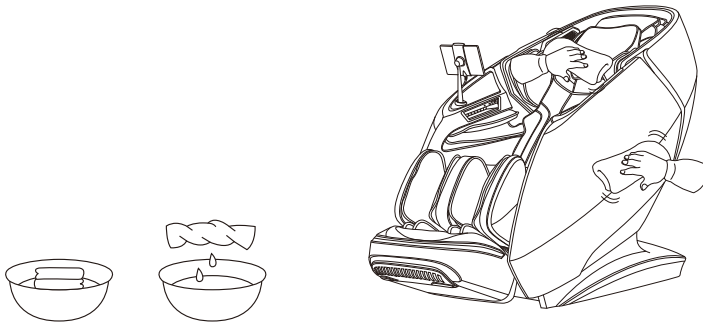

Troubleshooting

Fault	When the calf mechanism or the backrest reaches a certain position, press the corresponding adjustment button and it will no longer change, and a continuous "beep, beep" sound will be emitted.
Solution	Due to product structure design and ergonomic requirements, this product has a limited protection design for the limit state of attitude adjustment. At the same time, a reminder sound will sound when the limit is reached.
Fault	The function does not work or some functions do not work after the machine is turned on.
Solution	After the machine is turned on by pressing the switch key, it is necessary to manually select an automatic massage program or other working state. If it is not operated, the machine will automatically shut down after 20 minutes. If the manual operation mode is selected, the functions that are not selected may be disabled, and the working mode needs to be manually set in the manual mode.
Fault	The machine makes a leather rubbing sound when adjusting its posture.
Solution	This product adopts high-grade anti-corrosion leather that meets environmental protection requirements. Due to the inherent characteristics of leather materials, there will be a normal slight noise when rubbing at the relative movement, which is a normal phenomenon. Note: If you hear fabric or leather tearing sound when the machine is running, please stop using it immediately and seek professional maintenance.
Fault	The massage wheel did not reach the shoulders or neck.
Solution	If the head does not touch the head cushion or the back does not touch the backrest, the shoulder position may be lower than the actual position during the body shape detection process. Sit in the deepest position of the seat, rest your head on the headrest, and start over from the beginning.
Fault	The unit is damaged. The power cord or power plug is abnormally hot.
Solution	To prevent accidents, be sure to contact an authorized service center.

Please feel free to contact the designated service personnel for any questions or doubts about this product.

Product Specifications

Model: A665

Configure: 6

Name: Massage Chair

Rated voltage: 110-120V~ 60Hz
 220-240V~ 50Hz/60Hz

Rated power: 160W

Rated time: 20min

Safety structure: Class I

Material description: PVC, PA, steel parts, electric and electron components

MATERIAL	PU	LEATHER	CLOTH	WOOD

FCC Statement:

This device complies with part 15 of the FCC Rules. Operation is subject to the following two conditions:

(1) This device may not cause harmful interference, and

(2) this device

must accept any interference received, including interference that may cause undesired operation.

This equipment has been tested and found to comply with the limits for a Class B digital device, pursuant to part 15 of the FCC Rules. These limits are designed to provide reasonable protection against harmful interference in a residential installation. This equipment generates, uses and can radiate radio frequency energy and, if not installed and used in accordance with the instructions, may cause harmful interference to radio communications.

However, there is no guarantee that interference will not occur in a particular installation. If this equipment does cause harmful interference to radio or television reception, which can be determined by turning the equipment off and on, the user is encouraged to try to correct the interference by one or more of the following measures:

—Reorient or relocate the receiving antenna.

—Increase the separation between the equipment and receiver.

—Connect the equipment into an outlet on a circuit different from that to which the receiver is connected.

—Consult the dealer or an experienced radio/TV technician for help.

Caution: Any changes or modifications not expressly approved by the party responsible for compliance could void the user's authority to operate the equipment.

This equipment complies with FCC radiation exposure limits set forth for an uncontrolled environment. This transmitter must not be co-located or operating in conjunction with any other antenna or transmitter.

This equipment complies with FCC radiation exposure limits set forth for an uncontrolled environment. This equipment should be installed and operated with minimum distance of 20 cm between the radiator and your body.