

**INSIGNIA™**

**USER GUIDE**

Final Trim Size: 5.512 x 8.268 in. (140 x 210 mm)

# 3D Zero Gravity, Full-body Massage Chair

**NS-MGC600BK2**

**v1  
R5**

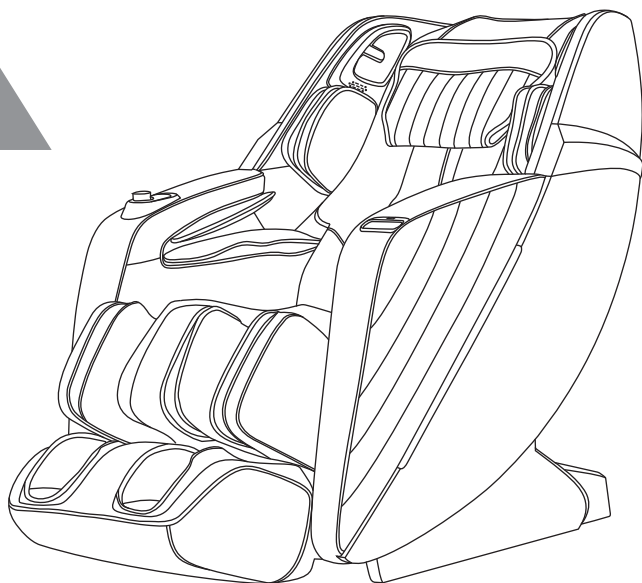

Before using your new product, please read these instructions to prevent any damage.

## Contents

IMPORTANT SAFETY INSTRUCTIONS .....	3
Features .....	5
Package contents .....	5
Components .....	6
Remote control .....	8
Armrest shortcut controls .....	10
Setting up your massage chair .....	11
Providing the correct power supply .....	11
Choosing a location .....	12
Moving your chair .....	13
Attaching or removing the cushions .....	13
Using your massage chair .....	14
Connecting power and turning on your chair .....	14
Turning off a running massage .....	15
Disconnecting power .....	16
Starting a massage .....	16
Manually changing the massage type .....	21
Adjusting massage functions .....	22
Adjusting manual mode options .....	24
Manually adjusting other customization options .....	25
Saving your massage settings .....	27
Loading a stored massage .....	28
Changing saved massage settings .....	30
Turning the remote beep on or off .....	31
Connecting a Bluetooth device .....	32
Checking your chair's software version .....	33
Checking your chair's equipment ID .....	34
Using zero gravity .....	35
Adjusting the lying angle .....	36
Troubleshooting .....	36
Service error codes .....	36
Specifications .....	38
Legal notices .....	38
ONE-YEAR LIMITED WARRANTY .....	40

# IMPORTANT SAFETY INSTRUCTIONS

**When using an electrical appliance, basic precautions should always be followed, including the following:**

Read all instructions before using (this appliance)

## **DANGER** - To reduce the risk of electric shock:

- Always unplug this appliance from the electrical outlet immediately after using and before cleaning.
- Keep dry – Do not operate in wet or moist conditions.

**WARNING** - Risk of collapse and serious injury. Maximum load **286.6 lbs. (130 kg).**

**WARNING** - To reduce the risk of burns, fire, electric shock, or injury to Persons:

- An appliance should never be left unattended when plugged in. Unplug from outlet when not in use, and before putting on or taking off parts.
- Close supervision is necessary when this appliance is used by, on, or near children, invalids, or disabled persons.
- Use the appliance only for its intended use as described in this manual. Do not use attachments not recommended by the manufacturer.
- Never operate this appliance if it has a damaged cord or plug, if it is not working properly, if it has been dropped or damaged. Return the appliance to a service center for examination and repair.
- Keep the cord away from heated surfaces.
- Never drop or insert any object into any opening.
- Do not use outdoors.
- Do not operate where aerosol (spray) products are being used or where oxygen is being administered.
- To disconnect, turn all controls to the off position, then remove plug from outlet.
- The appliance is intended for household and indoor use only.
- Connect this appliance to a properly grounded outlet only. See [GROUNDING INSTRUCTIONS](#) on page 4.
- Keep children away from extended foot support (or other similar parts)
- Do not use massager in close proximity to loose clothing or jewelry.
- Keep long hair away from massager while in use.
- Temperatures sufficiently high to cause burns may occur regardless of the control setting. Do not fall asleep on massage chair. The unattended use of heat pad by children or incapacitated persons may be dangerous. Do not use on sensitive skin or on a person with poor blood circulation. Check the skin in contact with the heated area of the appliance frequently to reduce the risk of blistering.

**CAUTION** - Use extreme caution with children. Your chair should not be accessible to child's play.

## SAVE THESE INSTRUCTIONS

## GROUNDING INSTRUCTIONS

This product must be grounded. If it should malfunction or breakdown, grounding provides a path of least resistance for electric current to reduce the risk of electric shock. This product is equipped with a cord that has an equipment grounding conductor and a grounding plug. The plug must be plugged into an appropriate outlet that is properly installed and grounded in accordance with all local codes and ordinances.

### **DANGER:** Improper connection of the equipment grounding

- An improperly installed conductor can result in a risk of electric shock. Check with a qualified electrician or serviceman if you are in doubt as to whether the product is properly grounded. Do not modify the plug provided with the product to make it fit the outlet. Have a proper outlet installed by a qualified electrician.
- This product is for use on nominal 120-volt circuit, and has a grounding plug. See [Providing the correct power supply](#) on page 11. If do not have a grounded receptacle, you can use a temporary adapter 2--pole receptacle. See [Providing the correct power supply](#) on page 11. Only use the temporary adapter until you have a qualified electrician install a properly grounded receptacle. While using a temporary adapter, the green colored rigid ear, lug, or the like extending from the adapter must be connected to a permanent ground such as a properly grounded outlet box cover, Whenever the adapter is used, it must be held in place by a metal screw.

## Features

- 3D digital audio lets you listen to music during a massage
- 21 unique programs target key areas of the body or manually create your own ideal massage
- Roller and air pressure combination provides maximum comfort and relaxation
- Armrest shortcut key lets you adjust the settings easily
- Auto extend footrest helps to relax your leg muscles
- Upper body scan lets the chair adjust to your precise measurements
- Memory function lets you set up, save, and load up to five customized massage modes
- Infrared heating helps to sooth sore muscles
- Polyurethane leather covering provides both comfort and durability
- Corded remote makes it easy to adjust your settings
- Automatic shutoff helps you save electricity and money
- Quick setup takes only five to ten minutes after unboxing

## Package contents

- 3D Zero Gravity, Full-body Massage Chair **Comment said to delete Full-body. Should the product description on the front cover also change?**
- Corded remote
- Power cord
- Fuse
- *User Guide*
- *Quick Setup Guide*
- **Leg Rest Installation I added this because it is a separate document.**

**Components**

**Front**

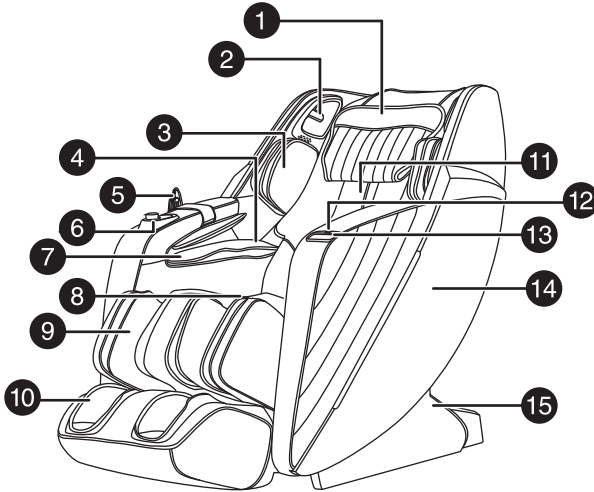

#	DESCRIPTION
1	Head cushion
2	3D digital <b>audio speakers</b>
3	Upper arm airbag component
4	Arm airbag component
5	Remote control
6	Armrest shortcut keypad
7	<b>Hand and forearm</b> Comment said to delete "magnetic and air therapy." So what is this a hand and forearm rest? We need a noun.
8	Seat cushion

#	DESCRIPTION
9	Leg rest
10	Footrest
11	Backrest
12	USB charging port
13	Mobile phone placement slot
<b>14</b>	Armrest
15	Side cover

## Back

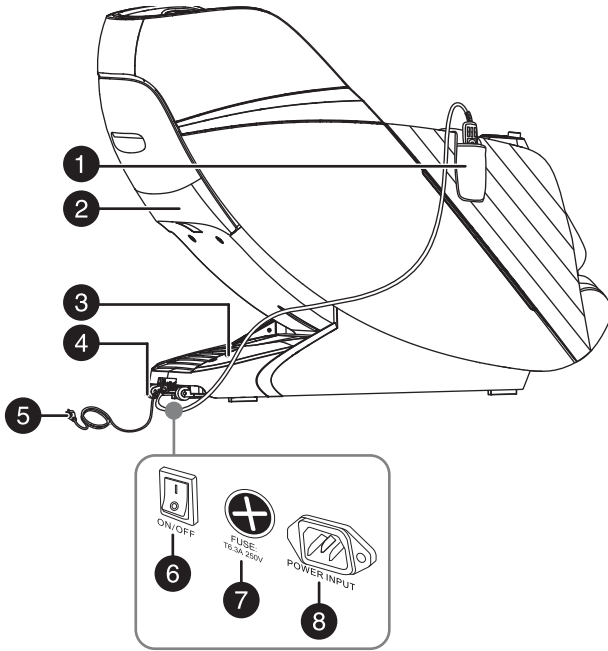

#	DESCRIPTION
1	Remote holder
2	Backrest cover
3	Drive box cover
4	Wheel





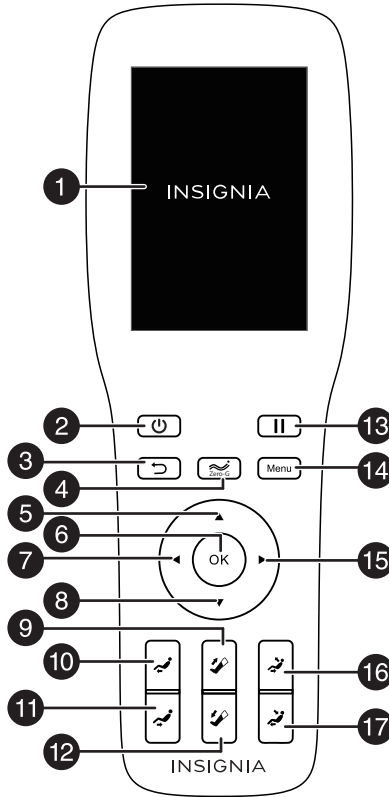

#	DESCRIPTION
5	Power cord and plug
6	Switch
7	Fuse holder
8	Power input

Remote control



#	ITEM	DESCRIPTION
1	Display	Shows the current settings for your chair.
2	⏻ (power)	Turns all massage functions on or off.
3	↶ (return)	Returns to the previous menu.
4	 (zero gravity)	Adjusts the angle of the massage chair for zero gravity. Each time you press the button, the angle changes. You can select from four levels. See <a href="#">Using zero gravity</a> on page 35.
5	▲ (up)	Moves up in a menu or adjusts an option upward.









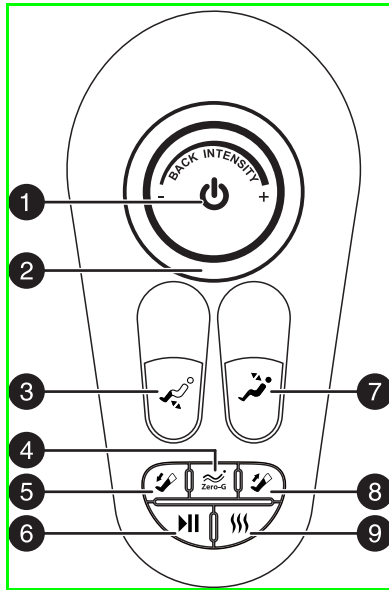

#	ITEM	DESCRIPTION
6	OK	Confirms a selection.
7	◀ (left)	Moves left in a menu.
8	▼ (down)	Moves down in a menu or adjusts an option downward.
9	 (footrest shortening)	Shortens and adjusts the footrest.
10	 (leg rest up)	Adjusts the leg rest upward.
11	 (leg rest down)	Adjusts the leg rest downward.
12	 (footrest lengthening)	Lengthens and adjusts the footrest.
13	(pause)	Stops or starts massage functions.
14	Menu	Opens the main menu.
15	▶ (right)	Moves right in a menu or opens a submenu.
16	 (linkage sitting)	When your chair is in the sitting position, adjusts the backrest and leg rest functions at the same time.
17	 (linkage lying)	When your chair is in the lying position, adjusts the backrest and leg rest functions at the same time.

### Armrest shortcut controls

Shortcut controls are built into the armrest.



#	ITEM	DESCRIPTION
1	 (power)	Press firmly once to turn on your massage chair. During an active massage, press once to pause or press and hold firmly for three to five seconds to turn off your massage chair. When turning off, hold the button until your chair returns to the upright position, then release.
2	 3D intensity knob	Adjusts the intensity of the 3D massage back roller.
3	 (calf rest control)	Adjusts the calf rest. Press up to raise the calf rest. Press down to lower the calf rest. The calf frame automatically detects the foot length.
4	 Zero-G (zero gravity)	Adjusts the positions of the leg rest and backrest for zero gravity. Each time you press the button, the angle changes. You can select from four levels. See <a href="#">Using zero gravity</a> on page 35.
5	 (footrest lengthen)	Lengthens and adjusts the footrest.

#	ITEM	DESCRIPTION
6	 (Bluetooth)	Controls Bluetooth. See <a href="#">Connecting a Bluetooth device</a> on page 32. Press to play or pause Bluetooth music. Press and hold for two seconds to connect or disconnect a Bluetooth device. Press and hold for four seconds to turn Bluetooth power on or off.
7	 (backrest control)	Adjust the backrest and calf rest. Press up to raise the backrest and lower the calf rest. Press down to lower the backrest and lower the calf rest.
8	 (footrest shortening)	Shortens and adjusts the footrest.
9	 (heat treatment)	Turns the heat treatment feature in the lower back area on or off.

## Setting up your massage chair

### Providing the correct power supply

**Note:**

Pressing  turns off your chair, but your chair is still receiving power. To cut power to your chair, turn off the rear power switch, then unplug the power cord.

- You must ground your chair. In the event of a malfunction or breakdown, grounding reduces the risk of electric shock by providing a path of least resistance for the electric current.
- Your chair has a power cord with a three-pronged grounding plug for use in a correctly installed and grounded outlet.
- The outlet must be correctly installed and grounded in accordance with all local codes and ordinances.

#### 3-prong plug and outlet

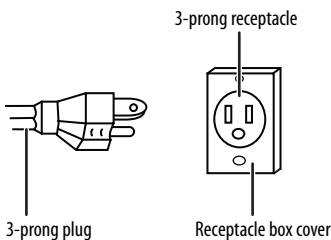

#### Grounding adapter

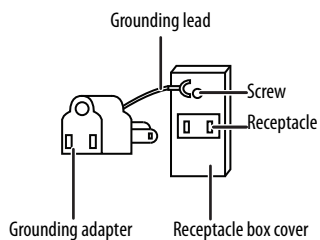

## Choosing a location

**CAUTION:**

- To prevent scratches on a wood or hard-surface floor, we recommend that two people carry your chair to its preferred location.
  - When carrying your chair, use the leg rest sealing plate and backrest cover grooves to lift your chair. Do not use the armrests to lift your chair.
- 
- Make sure that the location is close to a grounded power outlet.
  - Do not let the power cord extend across the floor to avoid accidental tripping.
  - Do not let your chair or any other item lay on the power cord.
  - If the location you select is a wood floor, place a rug or similar material under your chair to protect the floor from damage. The prolonged heavy pressure on your chair may cause scratches or dents on the floor.

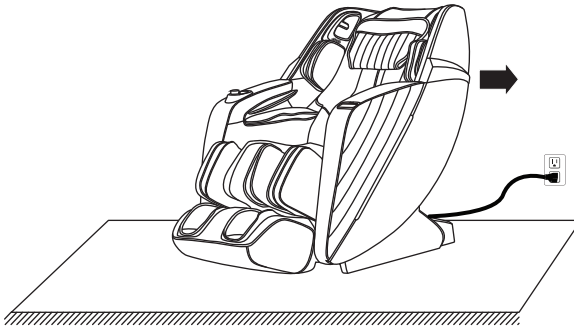

## Moving your chair

**CAUTION:**

The rear moving wheels on your chair are only suitable moving your chair for a short distance using slow movement. For long-distance transportation, use other auxiliary moving tools to move your chair.

- 1 Turn off your chair, then unplug the power and remote control cords. Make sure that the cords are out of the movement path.
- 2 Make sure that all the wires are pulled away from your chair's surface.
- 3 Press the backrest down. The center of gravity should be on the wheels.

**CAUTION:** Don't roll your chair on soft wood or on a laminated or vinyl floor to prevent damage to the floor.

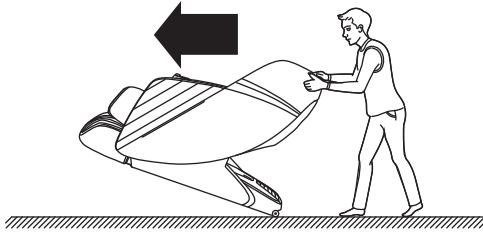

- 4 Push or pull your chair to the new location, then gently lower your chair.
- 5 Return the backrest to its normal position.
- 6 Plug the power cord and remote control cable back in.

## Attaching or removing the cushions

You can use the head cushion to reduce the intensity of kneading on your neck and shoulders. (We recommend using the head cushion.)

The backrest and back cushion are connected by a zipper.

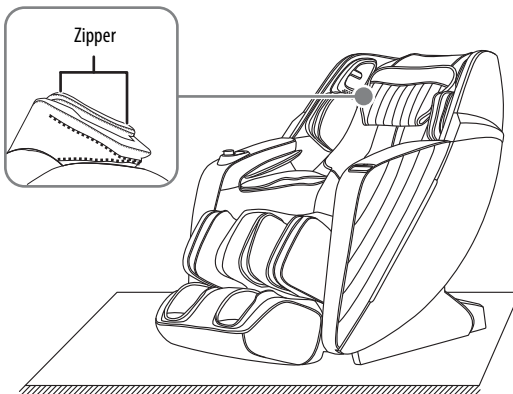

The head cushion and backrest are connected by a hook-and-loop fastener.

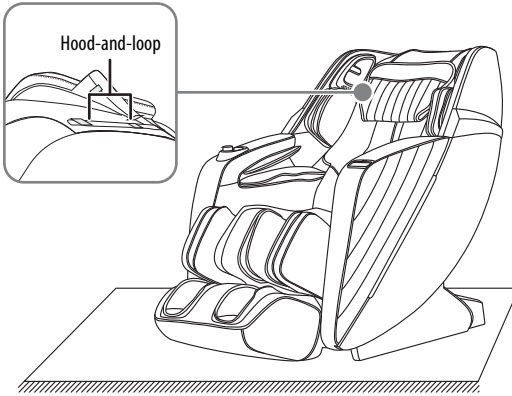

## Using your massage chair

### Connecting power and turning on your chair

- 1 Plug the power cord into the power input on the back of your chair.
- 2 Plug the power cord into a power outlet.

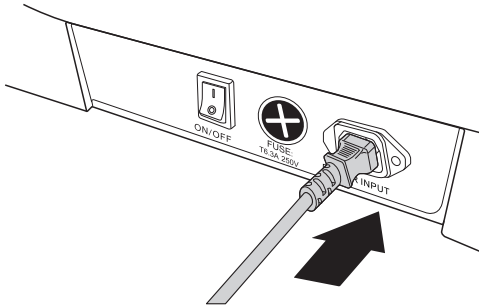

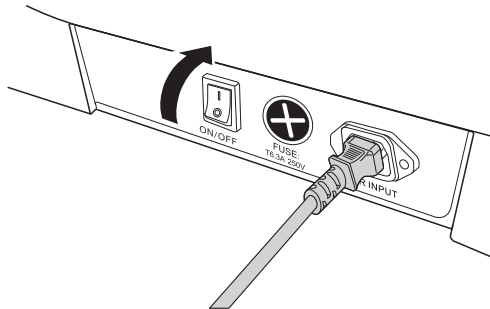

- 3 Press the **ON/OFF** switch on the back of your chair to the on position. Your chair turns on and enters standby mode.



**Note:** In standby mode, the remote control display is off. The only button that you can use is the  (power) button on the remote control or the armrest to turn your chair on.

### Turning off a running massage

If you press the  (power) button, the massage stops and the backrest, leg rest, and all massage functions return to the default positions for the selected massage program. When the massage program time is up, the backrest and leg rest do not return to the defaults.

**Note:** To return your chair to its upright position, hold the  (power) continuously until the chair is fully upright. Make sure that the area around your chair and under the footrest isn't blocked by any items and that nothing is under the footrest area.



## Disconnecting power

If you don't plan to use your chair for an extended period of time or you move your chair, you need to disconnect power.

- 1 Press the **ON/OFF** switch on the back of your chair to the off position.

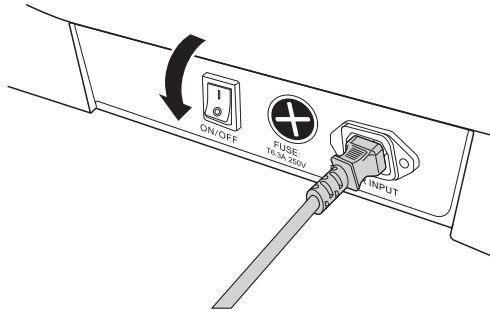

- 2 Unplug the power cord from the back of your chair and from the power outlet.

## Starting a massage

- 1 Press the  (power) button.
- 2 Press **OK**. The *Massage Type* screen opens with **3D** selected.

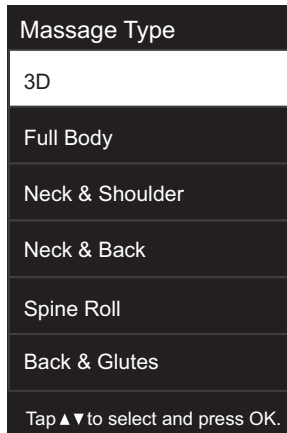



- 3 Press ▲ or ▼ to select a massage type, then press **OK**.

Your chair automatically adjusts the backrest and leg rest preset angle positions, then your chair automatically performs the shoulder position and body shape detection. After adjustments are complete, a beep sounds and the *Massage Mode* screen opens.

**Note:** If you do not select a massage program within five minutes, your chair turns off.

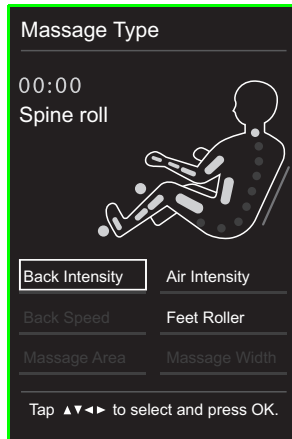

If you want to adjust shoulder height, see [Manually adjusting other customization options](#) on page 25.

## Massage types

<b>MASSAGE TYPE</b>	<b>DESCRIPTION</b>
3D	Provides a thorough body massage, focusing on kneading motions of upper and lower back.
Neck & Shoulder	Works to relieve tightness in the neck and shoulders and to improve blood circulation.
Neck & Back	Relieves tightness and pressure in the neck and the upper and lower back
Spine Roll	Provides a relaxing, stretching motion from the upper to lower back.
Back & Glutes	Massages the back and glutes to relieve tightness and pain.
Legs	Quickly relieves lower extremity pain and muscle fatigue.
Refresh	Improves blood circulation to the entire body.
Body Stretch	Relaxes your neck and shoulders and stretches your whole body.
Energize	After a night of rest, massages to quickly wake up and vitalize your body's functions.
Sport Recovery	Helps you quickly recover from physical fatigue after exercise.
Office Recovery	Provides perfect recovery after sitting at a desk for long periods of time.
Back Recovery	Focuses on improving back health and relieving back muscle soreness.
Back Stretch	Improves back issues caused by the lack of exercise.
Rejuvenation	Provides a perfect "time out" during the day to keep you performing at your best
Air Stretch	Uses the massaging air bags to stretch your body without using roller action.
Air Massage	Focuses on your full body to achieve full relaxation and provides a deep massage of your body to fully relieve fatigue and pain in your whole body.
Comfort massage	Provides the most comfortable massage.

MESSAGE TYPE	DESCRIPTION
Treat Yourself	Relieves body fatigue and soreness in your back and limbs.
Relaxation	Provides a gentle and comfortable deep massage to relieve body fatigue and relax your body.
Good Night	Massages the twelve major acupoints for healthcare to help the body to adjust balance and quickly improve sleep and sleep quality.

- 4 To change the shoulder position during an active massage, press Menu. The Main menu opens.

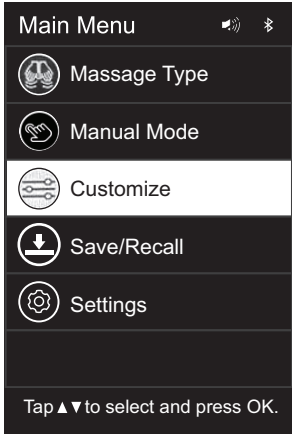

- 5 Press ▲ or ▼ to select **Customize**, then press **OK**. The *Customize* screen opens.

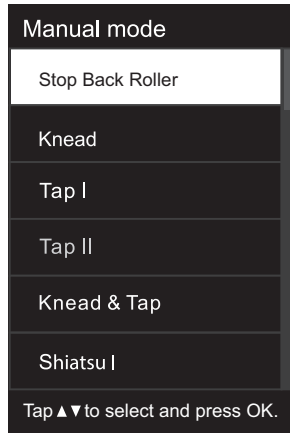

- 6 Press ▲ or ▼ to select **Shoulder Height**, then press **OK**. The *Shoulder position* screen opens.



- 7 Press ▲ or ▼ to adjust the shoulder roller position, then press **OK**.
- 8 Press ↵ (return) twice to return to the active massage screen.

## Manually changing the massage type

When a massage is running, you can change the massage type.

- 1 Press **Menu**. The *Main Menu* screen opens.

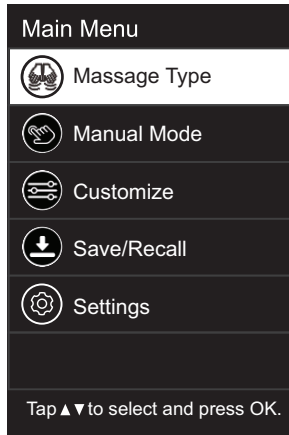

- 2 Press **(C)** to select **Message Type**, then press **OK**. The *Message Type* screen opens.

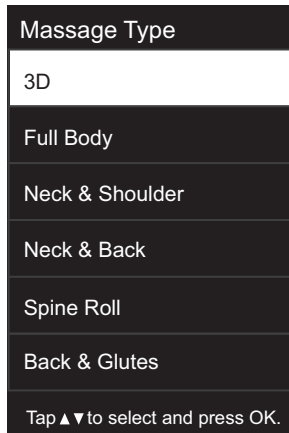

- 3 Press **▲** or **▼** to select the massage type you want, then press **OK**. See [Message types](#) on page 18.

## Adjusting massage functions

- 1 Press ▲ or ▼ to select one of the six adjustable settings, then press **OK**. A thin rectangle appears around the setting to show that the setting is currently selected.

**Note:** Depending on the massage type you pick, not all settings are adjustable.

- 2 Press **OK** to highlight a setting. then press the ◀ or ▶ to decrease or increase the intensity of the setting. White bars below the setting appear as you adjust the setting.
- 3 After you adjust a setting, press **OK** or ↶ to return to the list of settings.

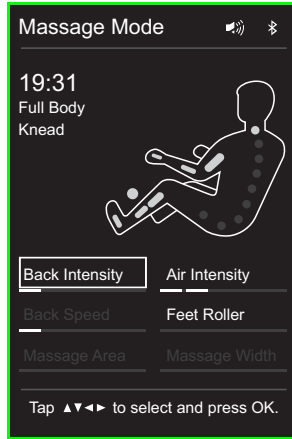

## Adjustment options

**Note:** After you have adjusted the settings to your preferences, you can save the settings for later use. See [Saving your massage settings](#) on page 27.

FUNCTION	DESCRIPTION
Back intensity	Adjusts the pressure of the back rollers from level <b>1</b> (soft) to level <b>5</b> (hard).
Back Speed	Adjusts the speed at which the <b>rollers</b> travel across the massage area in five levels.
Massage area	Selects the parts of the body that the rollers massage. The massage area is shown in text on upper left of screen next to <i>Area:</i> . You can select <b>Spot, Partial, Lower, Upper, or Full</b> .
Air intensity	Adjusts the pressure from the air pockets applied to hands, arms, feet, and calf areas. You can select <b>1, 2, 3, 4, 5, or OFF</b> .
Feet Roller	Adjusts the feet roller speed. You can select <b>1, 2, 3, or OFF</b> .
Massage width	Adjusts the gap between the right and left side rollers as they travel across the body. It has five levels from narrow to wide. The massage width is shown in text on upper left of screen next to <i>Width:</i> and under <i>Massage Width</i> on the lower right of the screen.

### Notes:

- Depending on the remaining massage time, some options are not displayed. For example, if the remaining massage time is 39 minutes, the displayed Massage time options are -5min and -10min (+10min or +5min cannot be displayed) because the maximum massage time is 40 minutes.
- The airbag intensity function only appears if you turned on the airbag feature or selected an automatic massage program that uses the airbag feature.

## Adjusting manual mode options

While the massage is running, you can adjust other manual mode options.

- 1 Press **Menu**. The *Main Menu* screen opens.

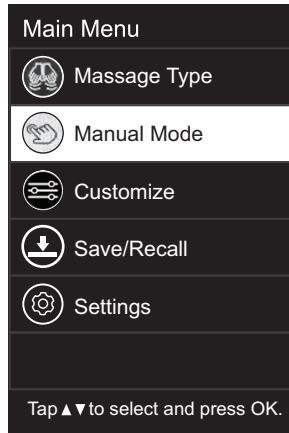

- 2 Press **▲** or **▼** to select **Manual Mode**, then press **OK**. The *Manual mode* screen opens.

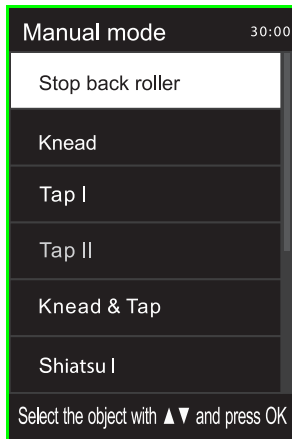



**Manual mode options**

TECHNIQUE	AVAILABLE ADJUSTMENTS	
Knead	Intensity, Speed, Air, and Massage Area	5 speed levels 5 width levels
Tap I	Intensity, Speed, Air, Massage Area, and Massage Width	
Tap II		
Knead & Tap	Intensity, Speed, Air, and Massage Area	
Shiatsu I	Intensity, Speed, Air, Massage Area, and Massage Width	
Shiatsu II		
Shoulder compress	Intensity, Speed, Air, and Massage Area	
3D I	Intensity, Speed, Air, and Massage Area	
3D II		
3D III		
3D IV		

**Manually adjusting other customization options**

- 1 After the massage starts, press **Menu** on the remote. The *Main Menu* screen opens.

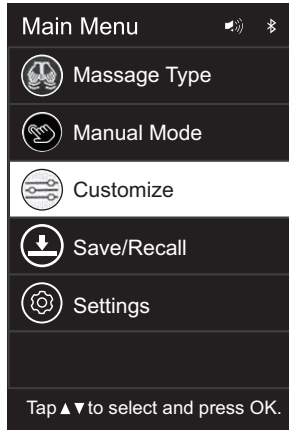

- 2 Press ▼ to select **Customize**, then press **OK**. The *Customize* screen opens.

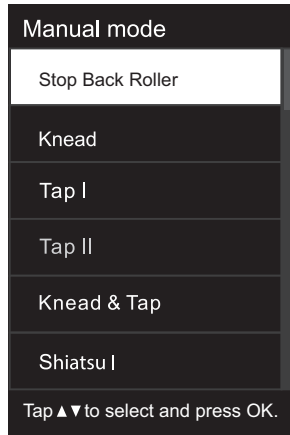

- 3 Press ▲ or ▼ to select an option, then press **OK** to see the available settings.

**Customization options**

OPTION	DESCRIPTION
Shoulder height	To adjust the shoulder height of the back roller, select <b>Set</b> , press <b>OK</b> , then adjust the height on the shoulder height screen.
Shoulder air	Includes the airbag massage for your shoulder. You can select <b>ON</b> or <b>OFF</b> .
Arms air	Includes the airbag massage for your arms. You can select <b>ON</b> or <b>OFF</b> .
Calf air	Includes the airbag massage for your calf. You can select <b>ON</b> or <b>OFF</b> .
Calf knead	Kneads the legs. You can select <b>ON</b> or <b>OFF</b> .
Feet air	Includes the airbag massage for your feet. You can select <b>ON</b> or <b>OFF</b> .
Back heat	Heats <b>your back in three levels</b> . Use ▲ or ▼ to select from three temperatures by using up and down arrow.
Massage time	Sets the massage time. You can select <b>-5 min</b> or <b>-10 min</b> to subtract time from the massage time, or <b>5 min</b> , or <b>10 min</b> to add to the massage time.

## Saving your massage settings

When you set up massage features to create a custom message, you can store this message for later use. Your chair can store up to five custom messages (**User 1** through **User 5**).

- 1 After the message starts, press **Menu** on the remote. The *Main Menu* screen opens.

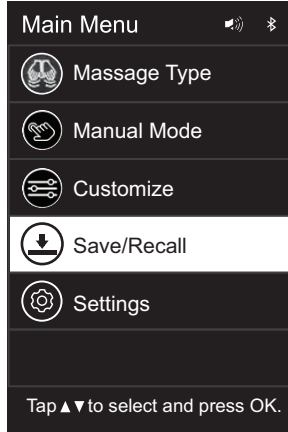

- 2 Press **▲** or **▼** to select **Save/Recall**, then press **OK**. The memory setup menu opens.

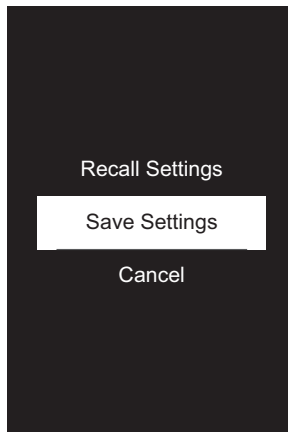

- 3 Press ▲ or ▼ to select **Save Settings**, then press **OK**. The *Memory Save* screen opens.



- 4 Press ▲ or ▼ to select a storage space, then press **OK**. You can select **User 1**, **User 2**, **User 3**, **User 4**, or **User 5**.
- 5 Press ◀ to return to the previous screen.

## Loading a stored massage

- 1 Press **Menu** on the remote. The *Main Menu* screen opens.

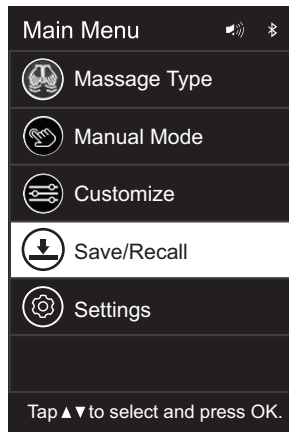

- 2 Press ▲ or ▼ to select **Save/Recall**, then press **OK**. The memory setup menu opens.

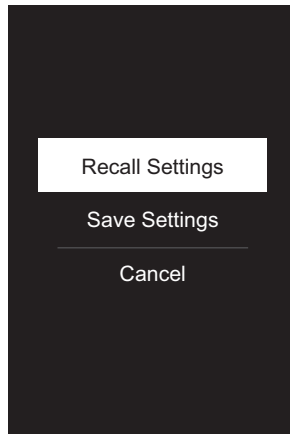

- 3 Press ▲ or ▼ to select **Recall Settings**, then press **OK**. The *Memory Save* screen opens.

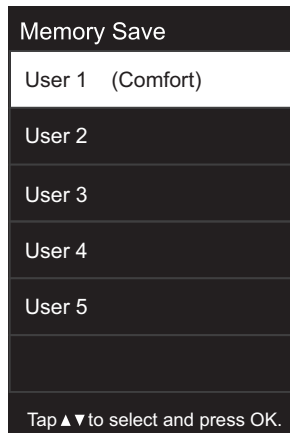

- 4 Press ▲ or ▼ to select a saved message, then press **OK**.

## Changing saved message settings

- 1 Press **Menu** on the remote. The *Main Menu* screen opens.

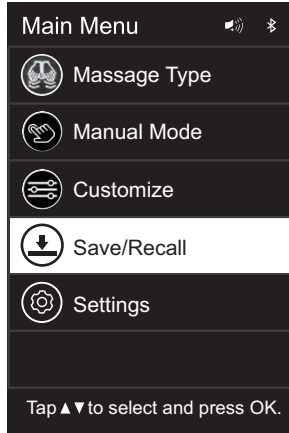

- 2 Press **▲** or **▼** to select **Save/Recall**, then press **OK**. The memory setup menu opens.

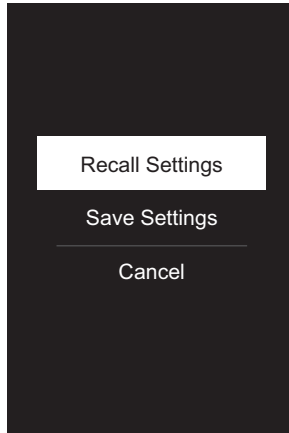

- 3 Press ▲ or ▼ to select **Recall Settings**, then press **OK**. The *Memory Save* screen opens.

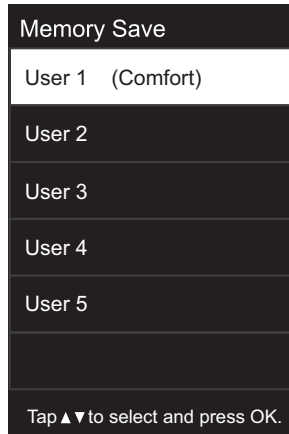

- 4 Press ↵ (return) three times to return to the main message Mode screen.
- 5 Change or customize the message settings. See [Adjusting message functions on page 22](#) or [Manually adjusting other customization options on page 25](#).
- 6 After you are done with all the customization and settings, save the new message. See [Saving your message settings on page 27](#).

## Turning the remote beep on or off

You can turn the remote control beep on or off.

- 1 Press **Menu** on the remote. The *Main Menu* screen opens.

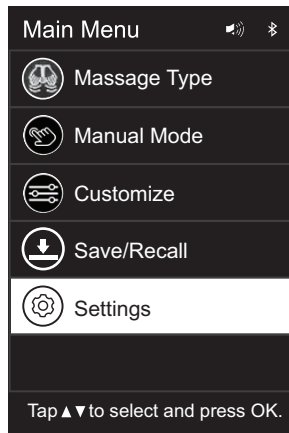

- 2 Press ▲ or ▼ to select **Settings**, then press **OK**. The *Setting* menu opens.

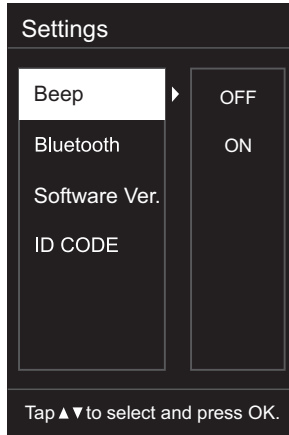

- 3 Press ► to access the settings, press ▲ or ▼ to select **On** or **Off**, then press **OK** to save your selection.
- 4 Press ↵ (return) twice to return to exit.

## Connecting a Bluetooth device

Your chair has digital audio speakers on the left and right armrests. You can connect a Bluetooth device (such as a cell phone or music player) to your chair wirelessly to play music. If your device needs to charge, you can also charge it by connecting it to the USB port on the left armrest.

- 1 Press **Menu** on the remote. The *Main Menu* screen opens.

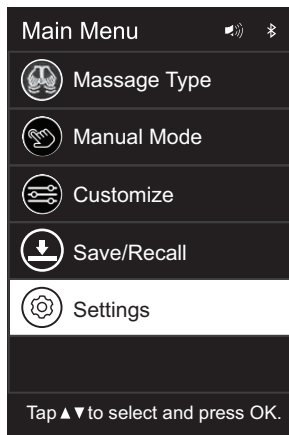



- Press ▲ or ▼ to select **Settings**, then press **OK**. The *Setting* menu opens.

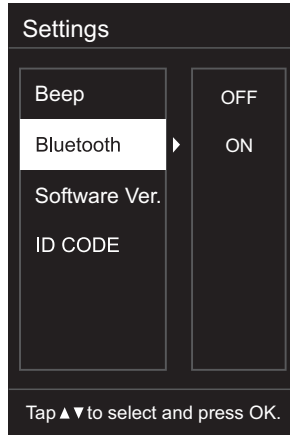

- Press ▲ or ▼ to select **Bluetooth**, then press ► to turn Bluetooth **ON** or **OFF**.
  - Press ◀ to return to the *Setting* menu.  
OR  
Press ↶ (return) twice to exit.
- Deleted step about connecting a Bluetooth device.**
- On the Bluetooth device, make sure that Bluetooth is turned on.
  - On the Bluetooth device, search for and select **NSMGC600BK2**.
  - Use the Bluetooth device to control playback.

## Checking your chair's software version

You can view your chair's software version.

- Press **Menu** on the remote. The *Main Menu* screen opens.

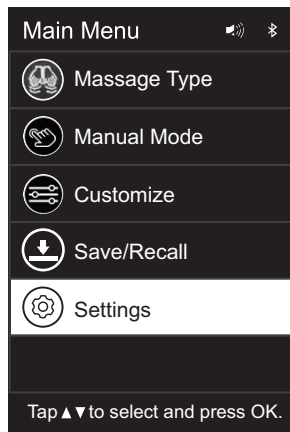

- 2 Press ▲ or ▼ to select **Settings**, then press **OK**. The *Setting* menu opens.

Per Fred at BB: iRest team, please provide the updated screen that shows both PCB and Remote version numbers.

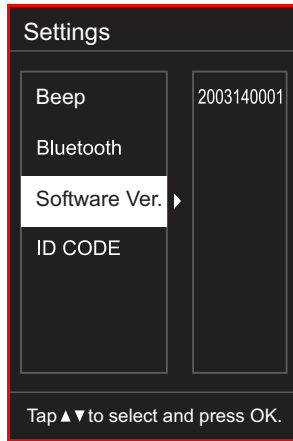

- 3 Press ► to view the software version number.
- 4 Press ◀ to return to the *Setting* menu.  
Press ↵ (return) twice to exit.

## Checking your chair's equipment ID

Your chair has an equipment ID that you can view.

- 1 Press **Menu** on the remote. The *Main Menu* screen opens.

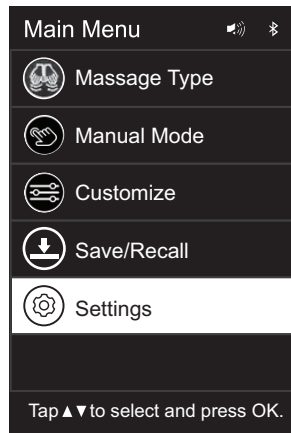

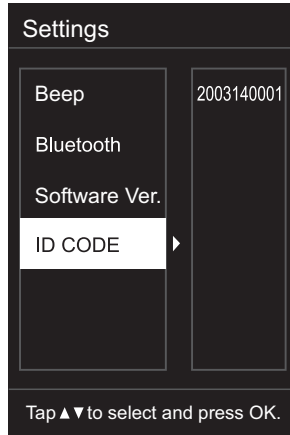

- 2 Press ▲ or ▼ to select **Settings**, then press **OK**. The *Setting* menu opens.









- 3 Press ► to view the equipment ID.  
 4 Press ◀ to return to the *Setting* menu.  
 OR  
 Press ↵ (return) twice to exit.

## Using zero gravity

In zero gravity, your chair distributes your weight evenly across your chair. Zero gravity helps relieve body pressure and tension.

BUTTON	DESCRIPTION
 Zero-G (zero gravity)	<p>Adjusts the backrest and leg rest positions automatically. You can select one of three positions.</p> <p>Press one or more times. Your chair automatically adjusts the backrest and leg rest positions. Each time you press , the zero gravity reclining positions change. You can select from three zero gravity positions.</p> <p>When you press  the fourth time, your chair returns to its original state.</p>

### Adjusting the lying angle

BUTTON	DESCRIPTION
 (calf rest up)	Adjusts the calf rest upward.
 (calf rest down)	Adjusts the calf rest downward.
 (footrest shortening)	Shortens and adjusts the footrest.
 (footrest lengthen)	Lengthens and adjusts the footrest.
 (linkage sitting)	When your chair is in the sitting position, adjusts the backrest and leg rest functions at the same time.
 (linkage lying)	When your chair is in the lying position, adjusts the backrest and leg rest functions at the same time.

### Troubleshooting

**Note:** If you run into unexpected problems with your massage chair, unplug the power cord, wait 30 seconds, then plug it back in. If you still experience issues, such as error codes, contact Insignia Customer Support at 1-877-467-4289 or visit [www.insigniaproducts.com](http://www.insigniaproducts.com).

### Service error codes

**Note:** If you run into unexpected problems with your massage chair, unplug the power cord, wait 30 seconds, then plug it back in. If you still experience issues, such as error codes, contact Insignia Customer Support.

ERROR CODE	PROBLEM	SOLUTION
B0	Communication error between back roller and main board	<ul style="list-style-type: none"> <li>• Replace the main board.</li> <li>• Reconnect the back roller cable.</li> </ul>

<b>ERROR CODE</b>	<b>PROBLEM</b>	<b>SOLUTION</b>
B9	The back roller did not receive a communication command from the main board within 10 seconds	<ul style="list-style-type: none"> <li>• Replace the main board.</li> <li>• Reconnect the back roller cable.</li> </ul>
FB	The upper and lower limit switches of the back roller are detected at the same time	<ul style="list-style-type: none"> <li>• Reconnect the upper and lower limit switch wires.</li> <li>• Replace the upper and lower testing board.</li> </ul>
FC	The back roller does not detect the position signal of the number of up and down laps within a unit time	<ul style="list-style-type: none"> <li>• Reconnect the walking laps number wires.</li> <li>• Replace the walking laps number testing board.</li> <li>• Replace the walking motor.</li> <li>• Replace the driver board of back roller.</li> <li>• Restart massage chair after power off.</li> </ul>
FD	During the up or down process of the back roller, no upper or lower limit signal was detected within 40 seconds.	<ul style="list-style-type: none"> <li>• Restart massage chair after power off.</li> <li>• Replace the walking motor.</li> <li>• Replace the walking testing board.</li> </ul>
F9	The driving circuit of the walking motor is overloaded or short-circuited	<ul style="list-style-type: none"> <li>• Replace the driver board of back roller.</li> <li>• Replace the walking motor.</li> <li>• Restart massage chair after power off.</li> </ul>
F6	Kneading width detection signal 1 cannot be detected	<ul style="list-style-type: none"> <li>• Replace the width testing board.</li> <li>• Replace the kneading motor.</li> <li>• Replace the driver board of back roller.</li> <li>• Restart massage chair after power off.</li> </ul>
F7	Kneading width detection signal 2 cannot be detected	<ul style="list-style-type: none"> <li>• Replace the width testing board.</li> <li>• Replace the kneading motor.</li> <li>• Replace the driver board of back roller.</li> <li>• Restart massage chair after power off.</li> </ul>

## Specifications

Dimensions (H x W x D)	54.7 x 47.2 x 34.8 in. (139 x 120 x 88.5 cm) These measurements should be listed in the following order: Height x Width x Depth. Are they in the correct order?
Weight	235.9 lbs (107 kg)
Rated voltage	110-120 V~60 Hz, 2 A
Default working time	20 minutes
Rated power	150 W
Power cord	6.8 ft. (206 cm)
Remote control cord	6.2 ft. (190 cm)
Bluetooth distance range	33 ft. (10 m)
Bluetooth profile version	V 5.0
Speaker sound/Amp wattage	3 W
THD distortion	< 2%

## Legal notices

### FCC Information

This device complies with Part 15 of the FCC Rules. Operation is subject to the following two conditions: (1) this device may not cause harmful interference, and (2) this device must accept any interference received, including interference that may cause undesired operation.

This equipment has been tested and found to comply with the limits for a Class B digital device, pursuant to part 15 of the FCC Rules.

These limits are designed to provide reasonable protection against harmful interference in a residential installation. This equipment generates, uses, and can radiate radio frequency energy and, if not installed and used in accordance with the instructions, may cause harmful interference to radio communications. However, there is no guarantee that interference will not occur in a particular installation. If this equipment does cause harmful interference to radio or television reception, which can be determined by turning the equipment off and on, the user is encouraged to try to correct the interference by one or more of the following measures:

- Reorient or relocate the receiving antenna.
- Increase the separation between the equipment and receiver.
- Connect the equipment into an outlet on a circuit different from that to which the receiver is connected.
- Consult the dealer or an experienced radio/TV technician for help.

Changes or modifications not expressly approved by the party responsible for compliance could void the user's authority to operate the equipment.

### ISED Statement

This device contains license-exempt transmitter(s)/receiver(s) that comply with Innovation, Science and Economic Development Canada's license-exempt RSS(s). Operation is subject to the following two conditions:

1. This device may not cause interference.

2. This device must accept any interference, including interference that may cause undesired operation of the device.

Ce dispositif contient des émetteurs exonérés de permis(s)/récepteurs) qui sont conformes aux RSS (s) exemptés de licence du Canada. L'opération est soumise aux deux conditions suivantes :

1. Cet appareil peut ne pas causer d'interférences.

2. Ce dispositif doit accepter toute interférence, y compris les interférences qui peuvent provoquer un fonctionnement indésirable de l'appareil.

### **RF Exposure**

This equipment complies with Innovation, Science and Economic Development Canada's radiation exposure limits set forth for an uncontrolled environment.

Cet équipement est conforme aux limites d'exposition aux rayonnements de Développement économique Canada pour l'innovation, les sciences et le développement économique établies dans un environnement incontrôlé.

## ONE-YEAR LIMITED WARRANTY

### Definitions:

The Distributor\* of Insignia branded products warrants to you, the original purchaser of this new Insignia-branded product ("Product"), that the Product shall be free of defects in the original manufacturer of the material or workmanship for a period of one (1) year from the date of your purchase of the Product ("Warranty Period").

For this warranty to apply, your Product must be purchased in the United States or Canada from a Best Buy branded retail store or online at [www.bestbuy.com](http://www.bestbuy.com) or [www.bestbuy.ca](http://www.bestbuy.ca) and is packaged with this warranty statement.

### How long does the coverage last?

The Warranty Period lasts for 1 year (365 days) from the date you purchased the Product. Your purchase date is printed on the receipt you received with the Product.

### What does this warranty cover?

During the Warranty Period, if the original manufacture of the material or workmanship of the Product is determined to be defective by an authorized Insignia repair center or store personnel, Insignia will (at its sole option): (1) repair the Product with new or rebuilt parts; or (2) replace the Product at no charge with new or rebuilt comparable products or parts. Products and parts replaced under this warranty become the property of Insignia and are not returned to you. If service of Products or parts are required after the Warranty Period expires, you must pay all labor and parts charges. This warranty lasts as long as you own your Insignia Product during the Warranty Period. Warranty coverage terminates if you sell or otherwise transfer the Product.

### How to obtain warranty service?

If you purchased the Product at a Best Buy retail store location or from a Best Buy online website ([www.bestbuy.com](http://www.bestbuy.com) or [www.bestbuy.ca](http://www.bestbuy.ca)), please take your original receipt and the Product to any Best Buy store. Make sure that you place the Product in its original packaging or packaging that provides the same amount of protection as the original packaging.

To obtain warranty service, in the United States and Canada call 1-877-467-4289. Call agents may diagnose and correct the issue over the phone.

### Where is the warranty valid?

This warranty is valid only in the United States and Canada at Best Buy branded retail stores or websites to the original purchaser of the product in the country where the original purchase was made.

### What does the warranty not cover?

This warranty does not cover:

- Food loss/spoilage due to failure of refrigerator or freezer
- Customer instruction/education
- Installation
- Set up adjustments
- Cosmetic damage
- Damage due to weather, lightning, and other acts of God, such as power surges
- Accidental damage
- Misuse
- Abuse
- Negligence
- Commercial purposes/use, including but not limited to use in a place of business or in communal areas of a multiple dwelling condominium or apartment complex, or otherwise used in a place of other than a private home.
- Modification of any part of the Product, including the antenna
- Display panel damaged by static (non-moving) images applied for lengthy periods (burn-in).



- Damage due to incorrect operation or maintenance
- Connection to an incorrect voltage or power supply
- Attempted repair by any person not authorized by Insignia to service the Product
- Products sold “as is” or “with all faults”
- Consumables, including but not limited to batteries (i.e. AA, AAA, C, etc.)
- Products where the factory applied serial number has been altered or removed
- Loss or Theft of this product or any part of the product
- Display panels containing up to three (3) pixel failures (dots that are dark or incorrectly illuminated) grouped in an area smaller than one tenth (1/10) of the display size or up to five (5) pixel failures throughout the display. (Pixel based displays may contain a limited number of pixels that may not function normally.)
- Failures or Damage caused by any contact including but not limited to liquids, gels or pastes.

REPAIR REPLACEMENT AS PROVIDED UNDER THIS WARRANTY IS YOUR EXCLUSIVE REMEDY FOR BREACH OF WARRANTY. INSIGNIA SHALL NOT BE LIABLE FOR ANY INCIDENTAL OR CONSEQUENTIAL DAMAGES FOR THE BREACH OF ANY EXPRESS OR IMPLIED WARRANTY ON THIS PRODUCT, INCLUDING, BUT NOT LIMITED TO, LOST DATA, LOSS OF USE OF YOUR PRODUCT, LOST BUSINESS OR LOST PROFITS. INSIGNIA PRODUCTS MAKES NO OTHER EXPRESS WARRANTIES WITH RESPECT TO THE PRODUCT, ALL EXPRESS AND IMPLIED WARRANTIES FOR THE PRODUCT, INCLUDING BUT NOT LIMITED TO ANY IMPLIED WARRANTIES OF AND CONDITIONS OF MERCHANTABILITY AND FITNESS FOR A PARTICULAR PURPOSE, ARE LIMITED IN DURATION TO THE WARRANTY PERIOD SET FORTH ABOVE AND NO WARRANTIES, WHETHER EXPRESS OR IMPLIED, WILL APPLY AFTER THE WARRANTY PERIOD. SOME STATES, PROVINCES AND JURISDICTIONS DO NOT ALLOW LIMITATIONS ON HOW LONG AN IMPLIED WARRANTY LASTS, SO THE ABOVE LIMITATION MAY NOT APPLY TO YOU. THIS WARRANTY GIVES YOU SPECIFIC LEGAL RIGHTS, AND YOU MAY ALSO HAVE OTHER RIGHTS, WHICH VARY FROM STATE TO STATE OR PROVINCE TO PROVINCE.

Contact Insignia:

**1-877-467-4289**

[www.insigniaproducts.com](http://www.insigniaproducts.com)

INSIGNIA is a trademark of Best Buy and its affiliated companies.

\*Distributed by Best Buy Purchasing, LLC

7601 Penn Ave South, Richfield, MN 55423 U.S.A.

©2021 Best Buy. All rights reserved.

INSIGNIA™

**[www.insigniaproducts.com](http://www.insigniaproducts.com)**

1-877-467-4289 (U.S. and Canada)

INSIGNIA is a trademark of Best Buy and its affiliated companies.

Distributed by Best Buy Purchasing, LLC

7601 Penn Ave South, Richfield, MN 55423 U.S.A.

©2021 Best Buy. All rights reserved.

V1 ENGLISH  
21-0426